



EN0802 Pre-Configured Kit Ships with 6-Port Phone Module and 4-Way, 2 GHz splitter

Efficient Distribution of Video, Voice and Data Services

EN0800, EN0802, EN0803, EN0804, EN0806, AC0506, AC0606, TM0106, TM0404, VM0104, VM0106, VM0108, VM0204, VM0206, and VM0208

8" Multi-Dwelling Unit (MDU) enclosure solution provides simple, cost-effective distribution of video, voice, and data services in residential projects.

Specify as a kit or a-la-carte solution featuring the options in the Ordering Information section

Features & Benefits

- With six video, two phone, and three data distribution options, solutions can be efficiently optimized for differing project specifications. Reference the Ordering Information section for complete details.
- Enclosure can be flush or surface mounted
 - For flush mounting, use the mounting tabs, sliders and drywall depth indicators to attach tightly and even to varying stud bay widths and drywall depths
 - For surface mounting, mounting holes are provided
- Screws are provided with the enclosure for mounting and optional door locking
- Knockouts for cable include screw driver holes to remove faster
- Elegant snap-on cover easily attaches and removes from the enclosure
- A six-pack of enclosures and covers (EN0806) is available to save cost and waste materials on large projects



EN0806 Bulk Pack of Six Enclosures and Covers

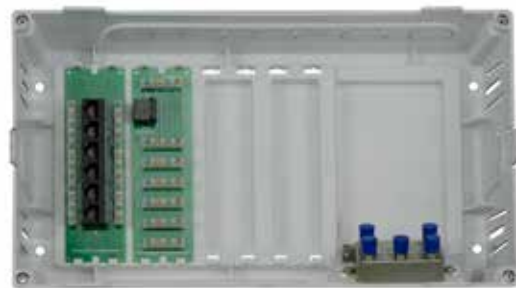

EN0803 Pre-Configured Kit Ships with 6-Port Phone Module, 4-Way 2 GHz splitter and 6-Port Cat5e Data Board

Compliance

- UL Listed
- Meets ANSI/TIA-568-C.2 Category 5e/Category 6 requirements

Technical Information

Performance

| | |
|---------------------------|--|
| Insertion/Extraction Life | 750 Cycles Minimum |
| IDC Wire Gauge | 22 ~ 24 AWG |
| Housing | High-Impact, Flame-Retardant Plastic, UL 94V-0 |
| Spring Wire | Phosphor Bronze Alloy Plated with 50 Microns of Gold |
| Paintable | Yes |
| Fabrication | ABS Plastic |
| Mounting Locations | Four |

MDU Enclosure Included Components

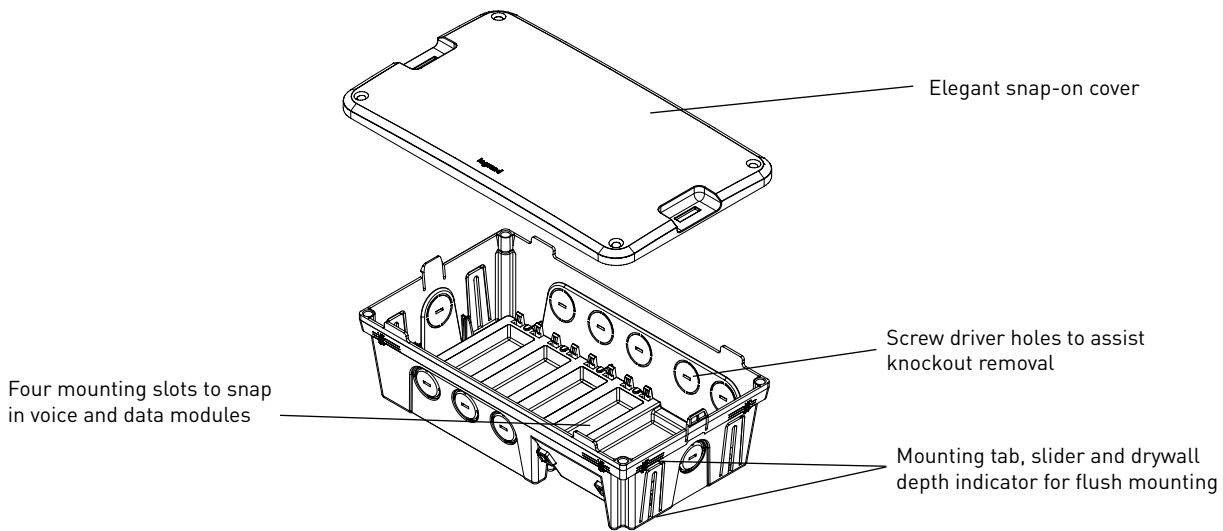

Enclosure Ordering Information

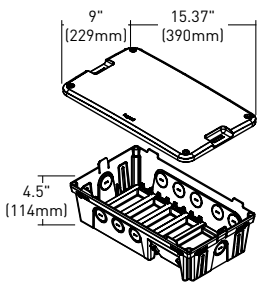

EN0800
8" MDU Enclosure and Cover, Empty

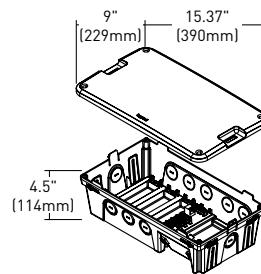

EN0802
8" MDU Enclosure Kit
Includes enclosure and cover with an installed 6-way phone module (TM0106) and 4-way coax splitter (VM0204).

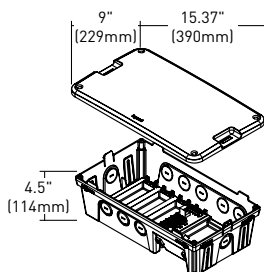

EN0803
8" MDU Enclosure Kit with Cat 5e Data
Includes enclosure and cover with an installed 6-way phone module (TM0106), 4-way coax splitter (VM0204) and 6-way Cat 5e data board (AC0506)

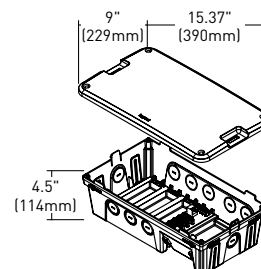

EN0804
8" MDU Enclosure Kit with Cat 6 Data
Includes enclosure and cover with an installed 6-way phone module (TM0106), 4-way coax splitter (VM0204) and 6-way Cat 6 data board (AC0606)

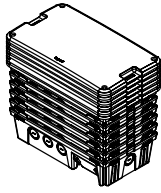
Enclosure Ordering Information (continued)

EN0806
8" MDU Enclosure Bulk Pack
 (6 enclosures & covers, Empty)

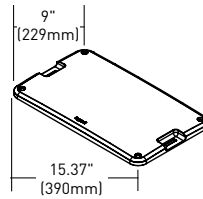

EN0801
8" MDU Enclosure Replacement Cover

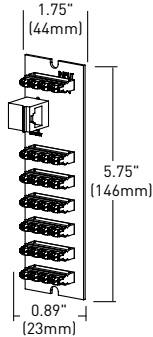
Accessories, Modules & Splitters Ordering Information

TM0106
1x6 Telephone Board with RJ31X

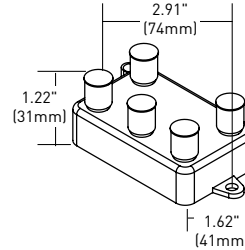

VM0104
4-Way Vertical Coax Splitter - 1 GHz

VM0204
4-Way Vertical Coax Splitter - 2 GHz

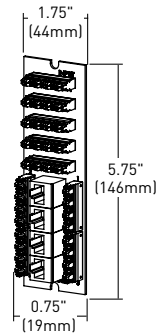

TM0404
Combo Phone & Cat 5e Data Board
 Distributes voice service to four locations and provides a termination point for four Cat 5e Ethernet runs.

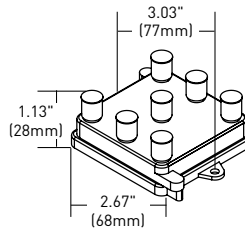

VM0106
6-Way Vertical Coax Splitter - 1 GHz

VM0206
6 Way Vertical Coax Splitter - 2 GHz

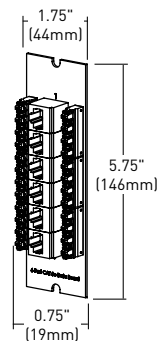

AC0506
6-Port Cat 5e Data Board
 Provides termination point and network interface for up to six Cat 5e Ethernet runs.

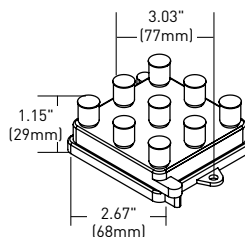

VM0108
8-Way Vertical Coax Splitter - 1 GHz

VM0208
8-Way Vertical Coax Splitter - 2 GHz

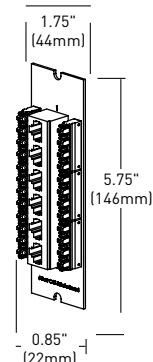

AC0606
6-Port Cat 6 Data Board
 Provides termination point and network interface for up to six Cat 6 Ethernet runs.