

Commercial Specification Grade Straight Blade Duplex Receptacles

2 Pole, 3 Wire Grounding
15A 125V, 20A 125V



INDUSTRIAL
COMMERCIAL
RESIDENTIAL

A-12 STRAIGHT BLADE RECEPTACLES

Duplex Receptacles

FEATURES

- Sturdy, compact design meets the demands of commercial spec grade performance.
- Excellent plug blade retention provided by triple-wipe 0.032" (0.81mm) triple-wipe brass line contacts and 0.050" (1.27mm) brass ground.
- High impact and chemical-resistant nylon face.
- 0.035" (0.89mm) galvanized steel, wrap-around yoke mounting strap for superior assembly security; extra length/width helps reach large panel cutouts for Code Compliance.
- Automatic grounding system eliminates need for bonding jumper in grounded metal enclosure, provides redundant measure of ground continuity where jumper used.
- Screw-Catch™ feature on duplex devices speeds mounting of wallplates.

Back and Side Wire

Rating A	V/AC	NEMA	Color	Catalog No.
15	125	5-15R	Almond	BR15A
			Black	BR15BK
			Brown	BR15B
			Gray	BR15GY
			Ivory	BR15V
			Light Almond	BR15LA
			White	BR15W
20	125	5-20R	Almond	BR20A
			Black	BR20BK
			Brown	BR20B
			Gray	BR20GY
			Ivory	BR20V
			Light Almond	BR20LA
			White	BR20W

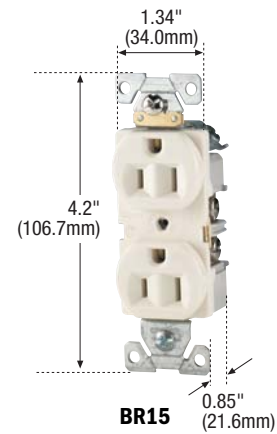

On 4" (101.6mm) Galvanized Steel Cover - Back and Side Wire

Rating A	V	NEMA	Color	Catalog No. Duplex
15	125	5-15R	Brown	869



869

TESTING & CODE COMPLIANCE

- UL Listed to 498 (file no. E15058), BR-series meets Federal Spec. W-C 596
- CSA (file no. 6914 (6233-01)). Meets all CSA requirements, C22.2 no. 42.
- NOM Certified.

MATERIAL CHARACTERISTICS

Meets Flammability requirements per UL 94. V2 rated.
Temperature Rating:
-20°C to 60°C.

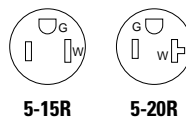

5-15R

5-20R

Commercial Specification Grade Straight Blade Receptacles

2 Pole, 3 Wire Grounding
15A 250V, 20A 125V,
15A 250V, 20A 250V,
20A 277V



INDUSTRIAL
COMMERCIAL
RESIDENTIAL

A-14 STRAIGHT BLADE RECEPTACLES

TESTING & CODE COMPLIANCE

- Listed to UL 498 (file nos. E2369 & E15058).
- CSA Certified to C22.2 no. 42, (file nos. LR7087 & 6914 (6233-01)).
- NOM Certified.

MATERIAL CHARACTERISTICS

Meets flammability requirements per UL 94, V2 rated.
Temperature Rating:
-20°C to 60°C.

Duplex And Single Receptacles

FEATURES

- Sturdy, compact design meets the demands of commercial spec grade performance.
- Excellent plug blade retention provided by triple-wipe 0.032" (0.81mm) triple-wipe brass line contacts and 0.050" (1.27mm) brass ground.
- High impact and chemical-resistant nylon face.
- 0.035" (0.889mm) galvanized steel, wrap-around yoke mounting strap for superior assembly security; extra length/width helps reach large panel cutouts for Code Compliance.
- Automatic grounding system eliminates need for bonding jumper in grounded metal enclosure, provides redundant measure of ground continuity where jumper used.
- Screw-Catch™ feature on duplex devices speeds mounting of wallplates.

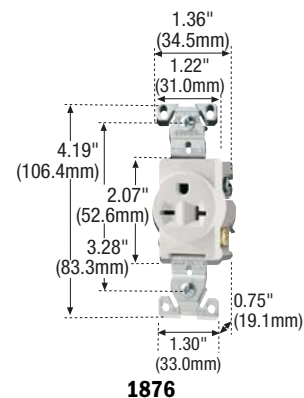
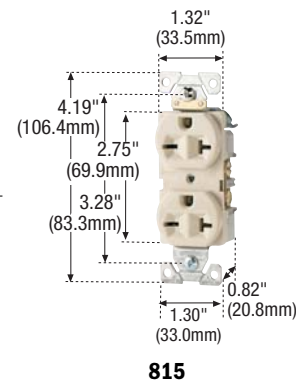
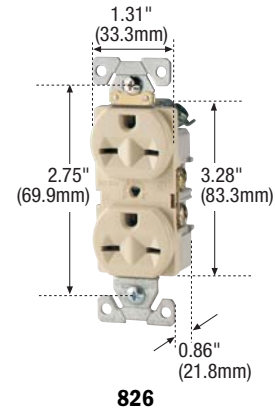

Side Wire			Catalog No.			
Rating			Colors	Duplex	Single*	
A	V/AC	NEMA				
15	125	5-15R	Almond	CR15A	817A	
			Black	CR15BK	—	
			Brown	CR15B	817B	
			Gray	CR15GY	—	
			Light Almond	CR15LA	817LA	
			Ivory	CR15V	817V	
			White	CR15W	817W	
20	125	5-20R	Almond	CR20A	1877A	
			Black	CR20BK	1877BK	
			Brown	CR20B	1877B	
			Gray	CR20GY	—	
			Light Almond	CR20LA	1877LA	
			Ivory	CR20V	1877V	
			White	CR20W	1877W	
15	250	6-15R	Almond	—	816A	
			Black	—	816BK	
			Brown	826B	816B	
			Light Almond	—	816LA	
			Ivory	826V	816V	
			White	826W	816W	
			20	250	6-20R	Almond
Black	—	1876BK				
Brown	815B	1876B				
Light Almond	—	1876LA				
Ivory	815V	1876V				
White	815W	1876W				

*Single receptacles meet all UL & CSA specifications, but differ in design and construction from duplexes noted above.

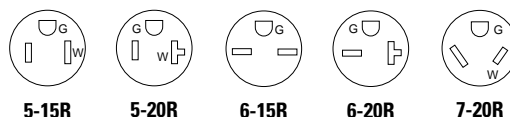



Standard Grade Straight Blade Duplex Receptacles

2 Pole, 3 Wire Grounding
15A 125V

INDUSTRIAL
COMMERCIAL
RESIDENTIAL

A-15 STRAIGHT BLADE RECEPTACLES

TESTING & CODE COMPLIANCE

- UL Listed to 498 (file no. E15058)
- CSA (file no. 6914 (6233-01)).
- Meets all CSA requirements, C22.2 no. 42.
- NOM certified.

MATERIAL CHARACTERISTICS

Meets flammability requirements per UL 94, VO rated.
Temperature Rating:
Side Wire
& Push Wire:
-20°C to 60°C.
Push Wire Only:
-40°C to 65°C.

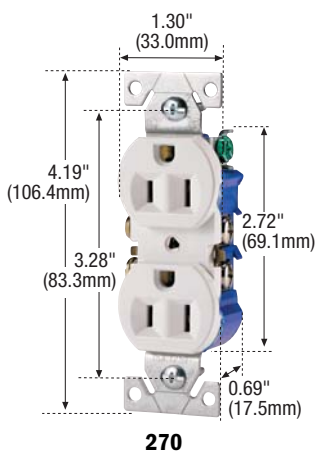

270

Standard Grade Duplex Receptacles

FEATURES

- Longer, wider strap provides 40% more contact area to wall board. Virtually eliminates floating installations.
- Screw-Catch™ feature automatically holds the wallplate and mounting screw in place.
- Built-in wire stripper for #14 and #12 wire provides backup for misplaced tools.
- Built-in wire looper designed to speed termination of both #14 and #12 wire.
- High impact-resistant thermoplastic face and back body eliminates job site breakage.
- Double wipe ground contacts ensure long-term ground retention.
- Easy access split circuit break-off tab.
- Side wire terminals accept up to #10 solid or stranded wire.
- Push-in terminals accept #14 solid wire.
- Terminal screws backed out - ready for wiring.
- Combination slot/Phillips head mounting and terminal screws ease installation (slot/Robertson screws in Canada where available).

Side Wire and Push Wire

Rating		NEMA	Color	Catalog No.		
A	V			Standard	Automatic Ground	Less Ears
15	125	5-15R	Almond	270A	270-9A	4270A
			Brown	270B	270-9B	4270B
			Ivory	270V	270-9V	4270V
			Light Almond	270LA	270-9LA	4270LA
			White	270W	270-9W	4270W

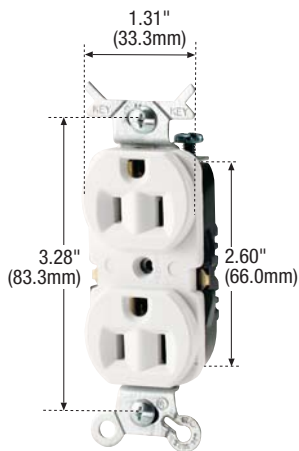

298

Standard Grade Duplex Receptacles

FEATURES

- Double wipe ground contacts to ensure long-term ground retention.
- Easy access split circuit break-off tab.
- Push-in terminals (8) accept #14 solid wire.
- Combination slot/Phillips head mounting and ground screws ease installation.

Push Wire Only

Rating		NEMA	Color	Catalog No.		
A	V			Standard	Less Ears	No Strap
15	125	5-15R	Black	—	—	298-2BK
			Brown	298B*	—	—
			Ivory	298V*	—	298-2V
			White	298W*	298-3W	—

*Not CSA



5-15R