

# XB Convection Heater

The Norseman™ XB Series convection heater, with ratings up to 5000 watts, is designed for heating spaces where explosive substances are or may be present. The Norseman™ XB is available with either cCSA<sub>US</sub> or CE/ATEX approvals. All units can be fitted with an externally adjustable thermostat.

With the Norseman™ XB, you get a safe and reliable heater with a handsome appearance and state-of-the-art design.

## Applications

Typical applications for the Norseman™ XB include:

- control cabinets and small enclosures
- storage rooms for paints and cleaners
- grain elevators
- flour mills
- spray booths
- gas plants
- pump houses
- marine and offshore
- oil platforms
- cleaning and dyeing plants

## Selection of Temperature Code

Refer to the atmospheric condition table (TABLE 2) at the beginning of this catalog for detailed selection data for the temperature code.

To minimize cost and physical size of the heater, select the heater with the highest temperature code that suits the environment. In TABLE 8 and TABLE 9 a check mark (✓) under the temperature code indicates that the surface temperature of the heater will not exceed the coded value listed in the atmospheric conditions table (TABLE 2) at the beginning of this catalog.

## Construction and Installation

The Norseman™ XP and the Norseman™ XB explosion-proof convection heaters utilize CCI Thermal's unique copper free aluminum extruded convector and patented **x-Max**® terminal housing. Large convector surface area and high mass fins ensure safe and efficient low temperature heat transfer to the environment. Convectors are black anodized to resist oxidation and maximize heat transfer.

The **x-Max**® housing can be equipped with multiple tapped conduit entries throughout its length to facilitate installation. A track and trolley system and threaded covers at each end allow easy access to internal components.

All units, except the single heat sink units, have a built-in terminal block for simplified electrical connection.

The Norseman™ XB units are intended for wall or floor mounting with the heater positioned vertically as shown. Dual purpose brackets for floor or wall mounting and wire guards are supplied as standard.

## Special Wattage and Lengths

The following table lists the maximum design wattages for the four standard heat sink lengths and configurations.

If standard units listed in TABLE 8 and TABLE 9 do not suit your application, a special unit based on TABLE 10 can be supplied (check factory).

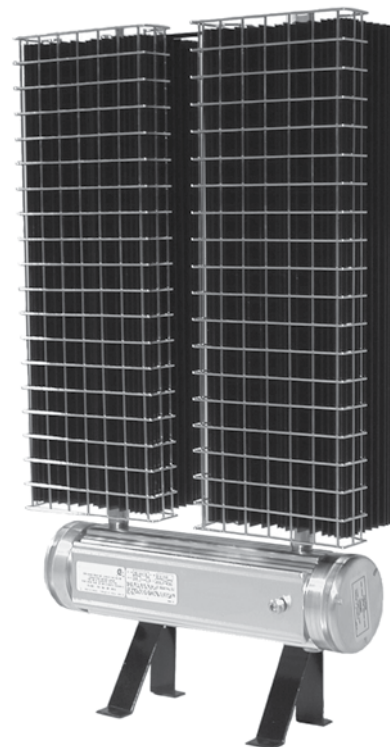

XB

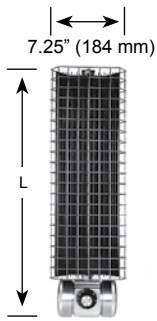

Figure 6 XB Single Unit (XB1)

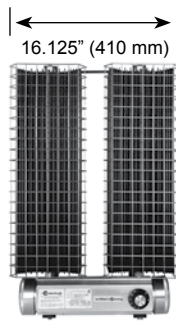

Figure 7 XB Double Unit (XB2)

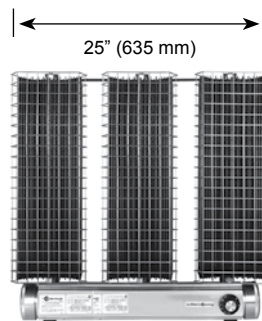

Figure 8 XB Triple Unit (XB3)

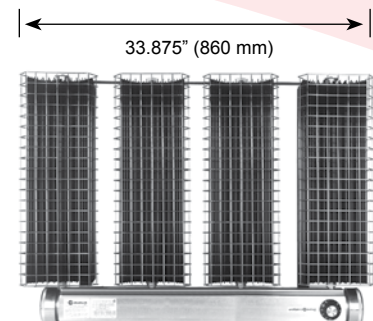

Figure 9 XB Quadruple Unit (XB4)

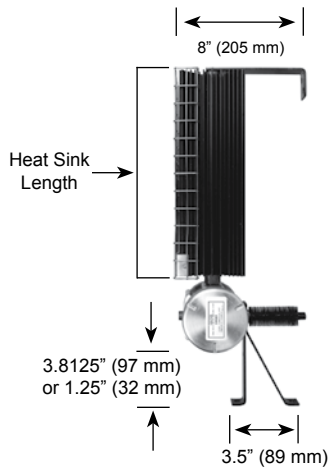

Figure 10 XB Side View Floor Mounting

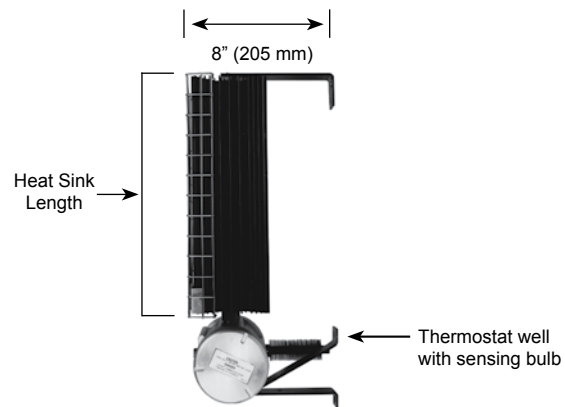

Figure 11 XB Side View Wall Mounting

**Note:**  
All units are shown with optional thermostat kit installed.

**TABLE 8 - Norseman™ XB Explosion-Proof Convection Heaters - Standard XB Heaters**

Watts	Standard Voltages								"L" Dimension in (mm)	Temperature Code				Weight lbs (kg)	Part No.			
	120		208		240		480			600		T2D	T3B		T4A	T6	Class I Division 1, 2 Group A, B, C & D Class II Division 1 Group E, F & G Class II Division 2 Group F & G Class III Division 1	Class I Division 1 Group A, B, C & D
	1Ø	1Ø	3Ø	1Ø	3Ø	1Ø	3Ø	1Ø		3Ø								
475	✓	✓	-	✓	-	-	-	-	-	10.0 (254)	✓	-	-	-	10 (4.5)	-	XB1-1047T2D	
750	✓	✓	-	✓	-	-	-	-	-	16.7 (424)	✓	-	-	-	15 (6.8)	-	XB1-3075T2D	
1000	✓	✓	-	✓	-	✓	-	✓	-	23.4 (594)	✓	-	-	-	20 (9.1)	-	XB1-4100T2D	
1250	✓	✓	-	✓	-	✓	-	✓	-	30.1 (765)	✓	-	-	-	25 (11.3)	-	XB1-6125T2D	
1500	✓	✓	✓	✓	✓	✓	-	-	-	16.7 (424)	✓	-	-	-	30 (13.6)	-	XB2-3150T2D	
2000	✓	✓	✓	✓	✓	✓	✓	✓	✓	23.4 (594)	✓	-	-	-	40 (18.1)	-	XB2-4200T2D	
3000	✓	✓	✓	✓	✓	✓	✓	✓	✓	23.4 (594)	✓	-	-	-	60 (27.2)	-	XB3-4300T2D	
3750	✓	✓	✓	✓	✓	✓	✓	✓	✓	30.1 (765)	✓	-	-	-	75 (34.0)	-	XB3-6375T2D	
4500	-	✓	✓	✓	✓	✓	✓	✓	✓	30.1 (765)	✓	-	-	-	100 (45.4)	-	XB4-6450T2D	

XB