



Applications



Approval / Marking



Add-on devices

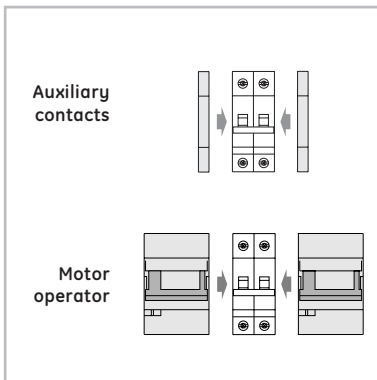

- Auxiliary contacts ● pg C.4
- Shunt trip ● pg C.6
- Motor operator ● pg C.8

Dimensions ● pg A.47

Miniature circuit breakers with UL approval

EP100 UL (Supplementary protection)

Recognized	UL 1077	10 kA
	EN/IEC 60898-1	10000
		3
	EN/IEC 60947-2	15 kA

Performances

Thermal setting I_n	(A) 0,5-63
Rated voltage AC U_n	(V) 277/480; 110V \equiv
Minimum operating voltage U_{Bmin}	(V) 12
Tripping characteristics	B-C-D
Selectivity class	3
Mechanical/electrical endurance	20000/10000
Tropicalisation acc. EN/IEC 60068-2-28/2-30	95%RH at 55°C
Terminal capacity flexible/rigid cable (mm ²)	25-35
Poles	1, 2, 3, 4
Weight/pole	(g) 125

Short-circuit capacity

According to UL 1077

Poles	V	I_{cc} (kA)
1	277	10
2, 3, 4	277/480	10

According to EN/IEC 60898-1

Poles	V	I_{cn}/I_{cs} (kA)
1	230/400	10
2, 3, 4	400	10

According to EN/IEC 60947-2

Poles	V	I_{cu} (kA) ⁽¹⁾
1	127	30
	240	15
	415	4
2, 3, 4	127	40
	240	30
	415	15
	440	10

DC according to EN/IEC 60947-2

Poles	U_n (V \equiv)	I_{cu} (kA)/ I_{cs} (kA)
1	60	25
2	125	30

(1) $I_{cs} = 50\% I_{cu}$



with UL 1077 approval

Series EP100 UL - 10kA - characteristics B-C-D



1P
1 mod.



In (A)	B		C		D		Pack.
	Cat. No.	Ref. No.	Cat. No.	Ref. No.	Cat. No.	Ref. No.	
0.5	-	-	EP101ULC0.5	686864	EP101ULD0.5	686940	12
1	-	-	EP101ULC01	686865	EP101ULD01	686941	12
2	-	-	EP101ULC02	686866	EP101ULD02	686942	12
4	-	-	EP101ULC04	686868	EP101ULD04	686944	12
6	EP101ULB06	686809	EP101ULC06	686870	EP101ULD06	686946	12
10	EP101ULB10	686810	EP101ULC10	686871	EP101ULD10	686947	12
16	EP101ULB16	686813	EP101ULC16	686874	EP101ULD16	686950	12
20	EP101ULB20	686814	EP101ULC20	686875	EP101ULD20	686951	12
25	EP101ULB25	686815	EP101ULC25	686876	EP101ULD25	686952	12
32	EP101ULB32	686817	EP101ULC32	686878	EP101ULD32	686954	12
40	EP101ULB40	686818	EP101ULC40	686879	EP101ULD40	686955	12
50	EP101ULB50	686819	EP101ULC50	686880	EP101ULD50	686956	12
63	EP101ULB63	686821	EP101ULC63	686882	EP101ULD63	686958	12



2P
2 mod.

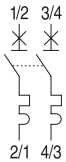

0.5	-	-	EP102ULC0.5	686883	EP102ULD0.5	686959	6
1	-	-	EP102ULC01	686884	EP102ULD01	686960	6
2	-	-	EP102ULC02	686885	EP102ULD02	686961	6
4	-	-	EP102ULC04	686887	EP102ULD04	686963	6
6	EP102ULB06	686823	EP102ULC06	686889	EP102ULD06	686965	6
10	EP102ULB10	686824	EP102ULC10	686890	EP102ULD10	686966	6
16	EP102ULB16	686827	EP102ULC16	686893	EP102ULD16	686969	6
20	EP102ULB20	686828	EP102ULC20	686894	EP102ULD20	686970	6
25	EP102ULB25	686829	EP102ULC25	686895	EP102ULD25	686971	6
32	EP102ULB32	686831	EP102ULC32	686897	EP102ULD32	686973	6
40	EP102ULB40	686832	EP102ULC40	686898	EP102ULD40	686974	6
50	EP102ULB50	686833	EP102ULC50	686899	EP102ULD50	686975	6
63	EP102ULB63	686835	EP102ULC63	686901	EP102ULD63	686977	6



3P
3 mod.

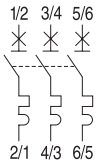

0.5	-	-	EP103ULC0.5	686902	EP103ULD0.5	686978	4
1	-	-	EP103ULC01	686903	EP103ULD01	686979	4
2	-	-	EP103ULC02	686904	EP103ULD02	686980	4
4	-	-	EP103ULC04	686906	EP103ULD04	686982	4
6	EP103ULB06	686837	EP103ULC06	686908	EP103ULD06	686984	4
10	EP103ULB10	686838	EP103ULC10	686909	EP103ULD10	686985	4
16	EP103ULB16	686841	EP103ULC16	686912	EP103ULD16	686988	4
20	EP103ULB20	686842	EP103ULC20	686913	EP103ULD20	686989	4
25	EP103ULB25	686843	EP103ULC25	686914	EP103ULD25	686990	4
32	EP103ULB32	686845	EP103ULC32	686916	EP103ULD32	686992	4
40	EP103ULB40	686846	EP103ULC40	686917	EP103ULD40	686993	4
50	EP103ULB50	686847	EP103ULC50	686918	EP103ULD50	686994	4
63	EP103ULB63	686849	EP103ULC63	686920	EP103ULD63	686996	4



4P
4 mod.

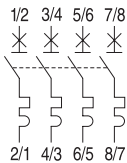

0.5	-	-	EP104ULC0.5	686921	EP104ULD0.5	686997	3
1	-	-	EP104ULC01	686922	EP104ULD01	686998	3
2	-	-	EP104ULC02	686923	EP104ULD02	686999	3
4	-	-	EP104ULC04	686925	EP104ULD04	687001	3
6	EP104ULB06	686851	EP104ULC06	686927	EP104ULD06	687003	3
10	EP104ULB10	686852	EP104ULC10	686928	EP104ULD10	687004	3
16	EP104ULB16	686855	EP104ULC16	686931	EP104ULD16	687007	3
20	EP104ULB20	686856	EP104ULC20	686932	EP104ULD20	687008	3
25	EP104ULB25	686857	EP104ULC25	686933	EP104ULD25	687009	3
32	EP104ULB32	686859	EP104ULC32	686935	EP104ULD32	687011	3
40	EP104ULB40	686860	EP104ULC40	686936	EP104ULD40	687012	3
50	EP104ULB50	686861	EP104ULC50	686937	EP104ULD50	687013	3
63	EP104ULB63	686863	EP104ULC63	686939	EP104ULD63	687015	3

with UL 1077 approval

On request: 3 - 5 - 13 - 15 - 30 - 60A

EP100 UL

A

B

C

D

E

F

G

X



Dimensional drawings

Miniature Circuit Breakers - Series C MCB with UL 489 approval - Series EP100 ULH

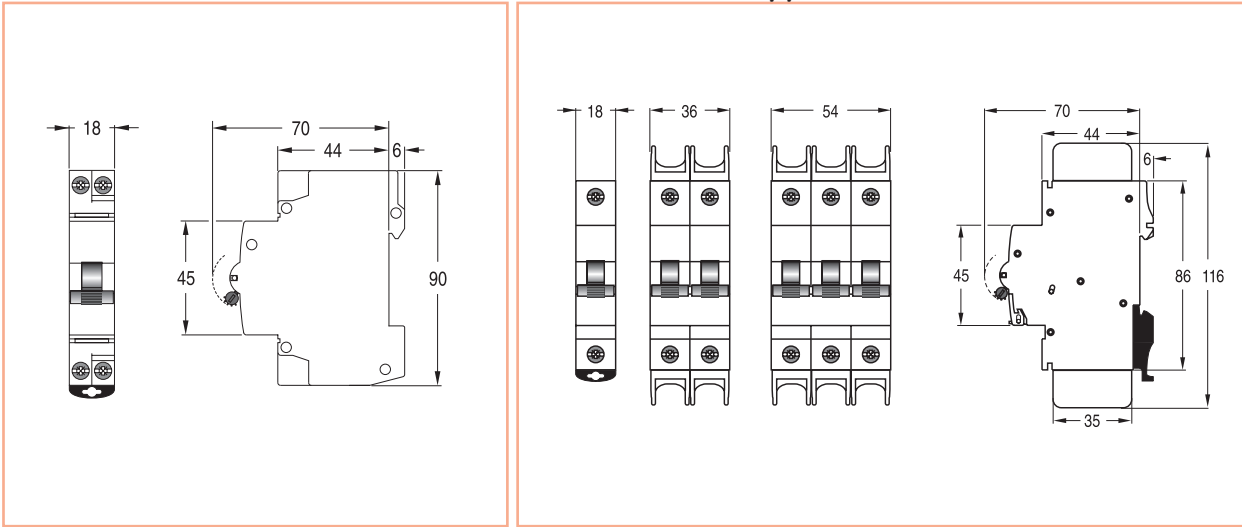

Miniature Circuit Breakers - Series G & GT and Series EP100 UC, EP60 UL and EP100 UL

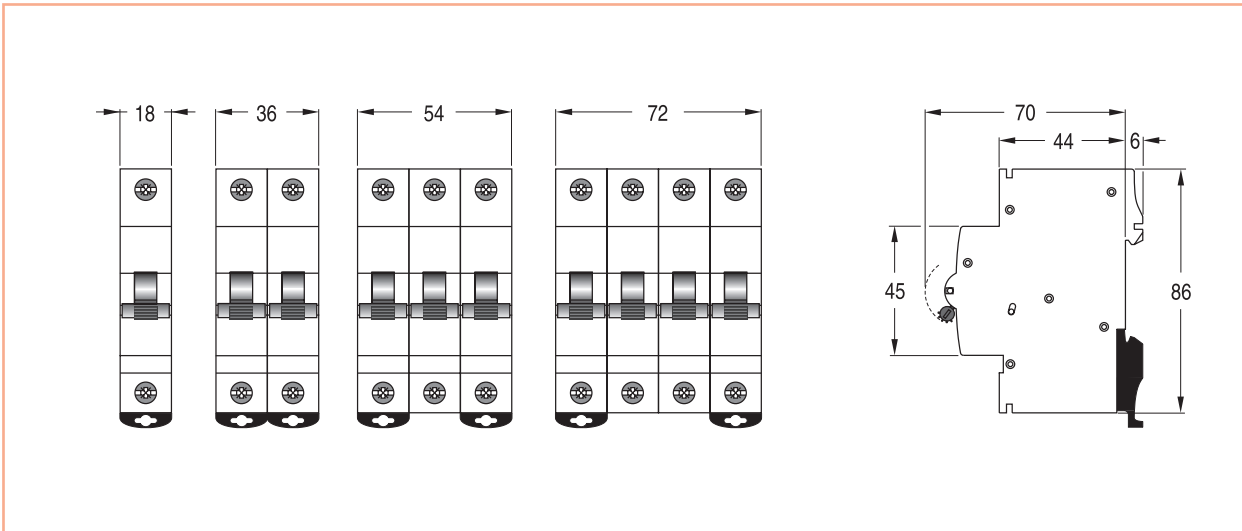

Miniature Circuit Breakers - Series EP60 and EP100

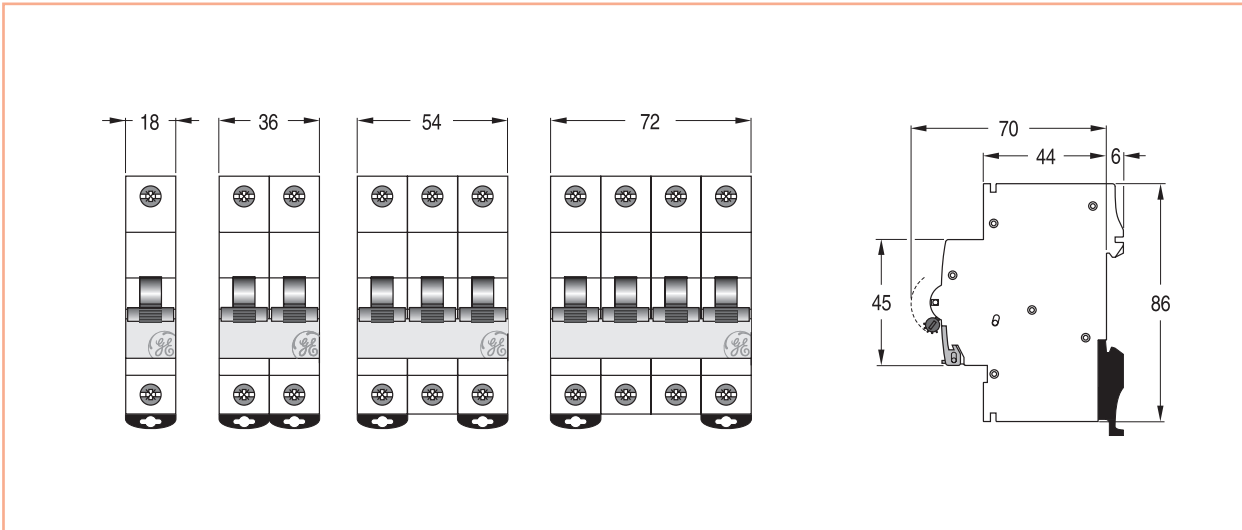

A

B

C

D

E

F

G

X