



The Lightolier Commercial Retrofit downlight is an easy to install downlight with adjustable lumen output switch. It offers lumen output ranging from 500lm to 3000lm, and trim options from 4 inch to 9.5 inch. This convenient downlight is ideal for retail store, residential and office application.

Project: \_\_\_\_\_  
 Location: \_\_\_\_\_  
 Cat.No: \_\_\_\_\_  
 Type: \_\_\_\_\_  
 Notes: \_\_\_\_\_

### Fixture

example: CR4R10927UW

Family	Size/Lumens	CRI	CCT	Voltage	Finish
<b>CR</b>		<b>9</b>		<b>U</b>	<b>W</b>
CR Commercial retrofit downlight	<b>4R10</b> 4" Round - 500lm/750lm/1000lm <b>6R15</b> 6" Round - 700lm/1000lm/1500lm <b>8R23</b> 8" Round - 1000lm/1500lm/2300lm <b>10R30</b> 9.5" Round - 1500lm/2000lm/3000lm	<b>9</b> 90CRI	<b>27</b> 2700K <b>30</b> 3000K <b>35</b> 3500K <b>40</b> 4000K	<b>U</b> 120/277V	<b>W</b> White

### Features

- Flange:** Aluminum white painted with baffle.
- Power supply:** Integral class 1 driver. (see Electrical section for specifications)
- Lifetime:** L70 at 50,000 hours and backed with a 5-year warranty (see www.lightolier.com for details).
- LED board:** Light emitted source.
- Power connection:** Trim is supplied with quick connect metal conduit with connector inside.
- 3 step switch:** Ability to switch to three different lumen package. Select the desired lumen output using the switch before installation. Lumen output can be changed after installation by un-installing the luminaire from the ceiling.

### Electrical

**Electronic power supply:** RoHS compliant. Class 1 power unit for use in a dry and damp locations.

### Labels

cULus listed.  
ENERGY STAR®.

Electrical Specs	Nominal Lumens	Input Volts	Input Freq.	Input Current	Input Power	THD Factor	Power Factor	Minimum Operating Temp.	Maximum Operating Temp.	IC/ Non-IC	Efficacy @90CRI 3000K
CR4R	500lm/750lm/1000lm	120-277V	60Hz	108mA	13W	<30%	>0.9	-20°C	40°C	IC	87.8lm/W
CR6R	700lm/1000lm/1500lm	120-277V	60Hz	158mA	19W	<30%	>0.9	-20°C	40°C	IC	85.2lm/W
CR8R	1000lm/1500lm/2300lm	120-277V	60Hz	234mA	28W	<30%	>0.9	-20°C	40°C	IC	88.8lm/W
CR10R	1500lm/2000lm/3000lm	120-277V	60Hz	333mA	40W	<30%	>0.9	-20°C	40°C	Non-IC	83.8lm/W

### Compatibility

Series	Frame Aperture Range		Compatible Lightolier Frames
	Minimum	Maximum	
CR4R Series	3.9" (99.06mm)	5.1" (129.54mm)	2001F13U, 2001F18U, 1001F13U, 1001F18U, 1001F26, 1101FD26MX1, 1001FD26MX2, 1001FD13M7U, 1001FD18M7U, 1001FD26M7U, 1002P1
CR6R Series	6" (152.4mm)	7.4" (187.96mm)	<del>1001F18U</del> , 1101F2642U, 1101FD2642MX1, 1101FD2642MX2, 1101FD2642M7U, 1102P1
CR8R Series	7.6" (193.04mm)	9.4" (238.76mm)	1700P1
CR10R Series	8.6" (218.44mm)	10.4" (264.16mm)	



# LED Commercial retrofit downlight

4", 6", 8" & 9.5" round aperture

## Dimensions

Retrofit downlight 4"

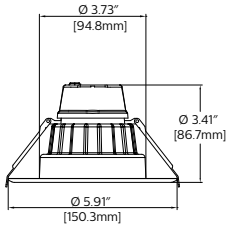

Retrofit downlight 6"

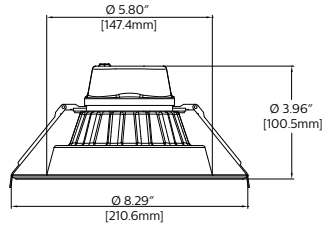

Retrofit downlight 8"

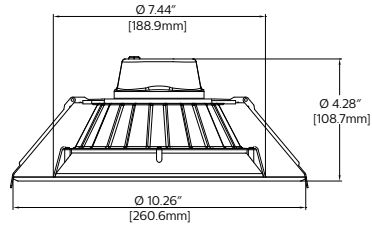

Retrofit downlight 9.5"

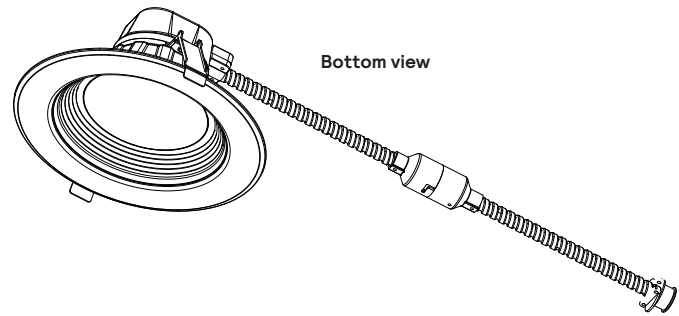
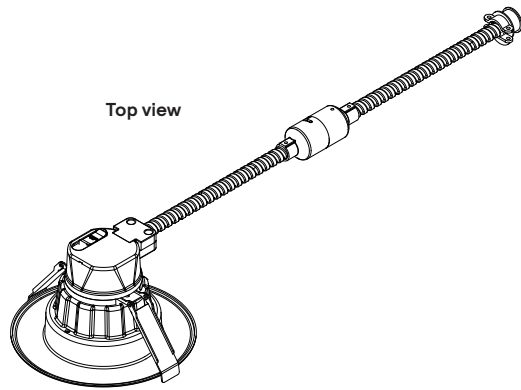
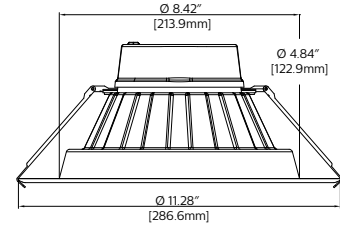

# LED Commercial retrofit downlight

4", 6", 8" & 9.5" round aperture

## Photometry

CRI	CCT	Multiplier
90	2700K	0.92
90	3000K	1.00
90	3500K	0.99
90	4000K	1.02

### 4-inch LED, 1000lm, 90CRI, 3000K

Angle	Mean CP	Lumens
0	523	53
5	518	
10	506	
15	489	152
20	466	
25	436	227
30	405	
35	367	270
40	330	
45	286	272
50	236	
55	186	232
60	143	
65	99	151
70	59	
75	28	49
80	14	
85	5	4
90	0	

#### CR4R10930UW

Output lumens:	1141 lm	Efficacy:	87.8lm/w
Spacing Criterion:	1.2	CCT <sup>3</sup> :	3000K
Input Watts <sup>2</sup> :	13.0 W	CRI:	90min

#### Single unit data

Height to Lighted Plane	Initial center beam foot-candles	Beam dia. (ft)*
5'	21	6.0'
6'	15	7.2'
7'	11	8.4'
8'	8	9.6'
9'	6	10.8'

\* Beam diameter is where foot-candles drop to 50% of maximum.

#### Multiple unit data - RCR 2

Spacing on center	Initial center beam foot-candles	Watts per sq.ft.
5'	21	0.58
6'	15	0.38
7'	11	0.27
8'	8	0.23
9'	6	0.18

38'x38'x10' Room, Workplane 2.5' above floor, 80/50/20% Reflectances

#### Coefficients of utilization

Ceiling	80%				70%		50%		30%		0%	
	70	50	30	10	50	10	50	10	50	10		
Wall	70	50	30	10	50	10	50	10	50	10	0	
RCR	Zonal cavity method - Effective floor reflectance = 20%											
Room Cavity Ratio	0	119	119	119	119	116	116	111	111	106	106	100
	1	110	106	103	100	104	98	100	95	96	92	87
	2	102	94	88	83	93	83	89	81	86	79	75
	3	94	84	77	71	83	70	80	69	77	68	65
	4	86	75	67	61	74	61	72	60	69	59	56
	5	80	68	60	53	67	53	65	53	63	52	50
	6	74	61	53	47	61	47	59	47	57	46	44
	7	69	56	48	42	55	41	54	42	52	41	39
	8	64	51	43	38	51	37	49	37	48	37	35
	9	60	47	39	34	47	34	46	34	45	34	32
	10	56	44	36	31	43	31	42	31	41	31	29

#### Zonal lumens & percentages

Zone	Lumens	%Luminaire
0-30	387	30.6%
0-40	618	49.8%
0-60	1004	85.5%
0-90	1141	100.0%

### 6-inch LED, 1500lm, 90CRI, 3000K

Angle	Mean CP	Lumens
0	663	63
5	659	
10	648	
15	627	177
20	600	
25	570	262
30	531	
35	501	311
40	457	
45	412	316
50	358	
55	295	265
60	234	
65	171	169
70	106	
75	51	57
80	17	
85	8	9
90	0	

#### CR6R15930UW

Output lumens:	1627lms	Efficacy:	85.2lm/w
Spacing Criterion:	1.2	CCT <sup>3</sup> :	3000K
Input Watts <sup>2</sup> :	19.1W	CRI:	90min

#### Single unit data

Height to Lighted Plane	Initial center beam foot-candles	Beam dia. (ft)*
5'	27	6.0'
6'	18	7.2'
7'	14	8.4'
8'	10	9.6'
9'	8	10.8'

\* Beam diameter is where foot-candles drop to 50% of maximum.

#### Multiple unit data - RCR 2

Spacing on center	Initial center beam foot-candles	Watts per sq.ft.
5'	27	0.85
6'	18	0.56
7'	14	0.40
8'	10	0.33
9'	8	0.26

38'x38'x10' Room, Workplane 2.5' above floor, 80/50/20% Reflectances

#### Coefficients of utilization

Ceiling	80%				70%		50%		30%		0%	
	70	50	30	10	50	10	50	10	50	10		
Wall	70	50	30	10	50	10	50	10	50	10	0	
RCR	Zonal cavity method - Effective floor reflectance = 20%											
Room Cavity Ratio	0	119	119	119	119	116	116	111	111	106	106	100
	1	110	106	102	99	104	97	99	94	96	91	86
	2	101	93	87	82	91	81	88	79	85	77	74
	3	92	83	75	69	81	68	78	67	75	66	63
	4	85	74	65	59	72	59	70	58	68	57	54
	5	78	66	57	51	65	51	63	50	61	50	47
	6	72	60	51	45	59	45	57	44	55	44	41
	7	67	54	46	40	53	40	52	39	50	39	37
	8	63	49	41	36	49	35	47	35	46	35	33
	9	58	45	37	32	45	32	44	32	43	32	30
	10	55	42	34	29	41	29	40	29	40	29	27

#### Zonal lumens & percentages

Zone	Lumens	%Luminaire
0-30	501	33.9%
0-40	812	54.1%
0-60	1393	87.9%
0-90	1627	100.0%

1. Tested using absolute photometry as specified in LM79: IESNA Approved Method for the Electrical and Photometric Measurements of Solid-State Lighting Products.
2. Wattage: controlled to within 5%
3. Correlated Color Temperature: within specs as defined in ANSI\_NEMA\_ANSI C78.377-2008: Specifications for the Chromaticity of Solid State Lighting Products.

# LED Commercial retrofit downlight

4", 6", 8" & 9.5" round aperture

## Photometry - continued

### 8-inch LED, 2300lm, 90CRI, 3000K

#### Candela Curve

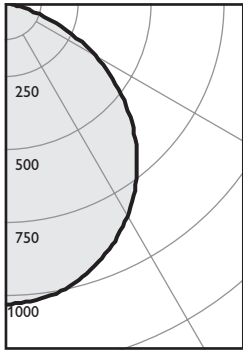

Angle	Mean CP	Lumens
0	934	
5	927	88
10	909	
15	882	248
20	840	
25	794	366
30	739	
35	681	429
40	632	
45	569	435
50	490	
55	413	368
60	329	
65	248	244
70	165	
75	82	93
80	24	
85	9	11
90	1	

#### Single unit data

Height to Lighted Plane	Initial center beam foot-candles	Beam dia. (ft)*
5'	37	6.0'
6'	26	7.2'
7'	19	8.4'
8'	15	9.6'
9'	12	10.8'

\* Beam diameter is where foot-candles drop to 50% of maximum.

#### Multiple unit data - RCR 2

Spacing on center	Initial center beam foot-candles	Watts per sq.ft.
5'	37	1.14
6'	26	0.75
7'	19	0.53
8'	15	0.44
9'	12	0.36

38'x38'x10' Room, Workplane 2.5' above floor, 80/50/20% Reflectances

#### Coefficients of utilization

Ceiling	80%				70%		50%		30%		0%	
	70	50	30	10	50	10	50	10	50	10	0	
Wall	70	50	30	10	50	10	50	10	50	10	0	
RCR	Zonal cavity method - Effective floor reflectance = 20%											
Room Cavity Ratio	0	119	119	119	119	116	116	111	111	106	106	100
	1	110	106	102	98	103	97	99	94	95	91	86
	2	101	93	87	82	91	81	88	79	85	77	73
	3	92	82	75	69	81	68	78	67	75	66	62
	4	85	73	65	59	72	58	70	57	67	57	54
	5	78	66	57	51	65	50	63	50	61	49	47
	6	72	59	51	45	58	44	57	44	55	44	41
	7	67	54	45	39	53	39	52	39	50	39	37
	8	62	49	41	35	49	35	47	35	46	35	33
	9	58	45	37	32	45	32	44	32	42	31	30
10	55	42	34	29	41	29	40	29	39	29	27	

#### Zonal lumens & percentages

Zone	Lumens	%Luminaire
0-30	701	30.6%
0-40	1130	49.8%
0-60	1934	85.5%
0-90	2281	100.0%

#### CR8R23930UW

Output lumens:	2281 lm	Efficacy:	88.8lm/w
Spacing Criterion:	1.2	CCT <sup>3</sup> :	3000K
Input Watts <sup>2</sup> :	25.7 W	CRI:	90min

### 9.5-inch LED, 3000lm, 90CRI, 3000K

#### Candela Curve

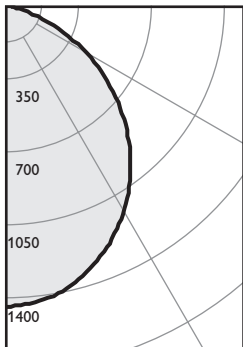

Angle	Mean CP	Lumens
0	1234	
5	1227	116
10	1204	
15	1165	328
20	1113	
25	1049	483
30	976	
35	895	560
40	810	
45	721	556
50	631	
55	535	476
60	432	
65	330	327
70	229	
75	132	141
80	44	
85	9	13
90	0	

#### Single unit data

Height to Lighted Plane	Initial center beam foot-candles	Beam dia. (ft)*
5'	49	6.0'
6'	34	7.2'
7'	25	8.4'
8'	19	9.6'
9'	15	10.8'

\* Beam diameter is where foot-candles drop to 50% of maximum.

#### Multiple unit data - RCR 2

Spacing on center	Initial center beam foot-candles	Watts per sq.ft.
5'	53	1.59
6'	37	1.04
7'	27	0.74
8'	21	0.62
9'	16	0.50

38'x38'x10' Room, Workplane 2.5' above floor, 80/50/20% Reflectances

#### Coefficients of utilization

Ceiling	80%				70%		50%		30%		0%	
	70	50	30	10	50	10	50	10	50	10	0	
Wall	70	50	30	10	50	10	50	10	50	10	0	
RCR	Zonal cavity method - Effective floor reflectance = 20%											
Room Cavity Ratio	0	119	119	119	119	116	116	111	111	106	106	100
	1	110	106	102	98	103	97	99	94	95	91	86
	2	101	93	87	81	91	80	88	78	84	77	73
	3	92	82	74	68	81	68	78	66	75	65	62
	4	85	73	65	58	72	58	69	57	67	56	54
	5	78	66	57	51	64	50	62	50	60	49	47
	6	72	59	51	44	58	44	56	44	55	43	41
	7	67	54	45	39	53	39	51	39	50	39	36
	8	62	49	41	35	49	35	47	35	46	35	33
	9	58	45	37	32	45	32	44	32	42	31	29
10	55	42	34	29	41	29	40	29	39	29	27	

#### Zonal lumens & percentages

Zone	Lumens	%Luminaire
0-30	928	30.9%
0-40	1488	49.6%
0-60	2520	84.0%
0-90	3000	100.0%

#### CR10R30930UW

Output lumens:	3000 lm	Efficacy:	83.8lm/w
Spacing Criterion:	1.2	CCT <sup>3</sup> :	3000K
Input Watts <sup>2</sup> :	35.8 W	CRI:	90min

1. Tested using absolute photometry as specified in LM79: IESNA Approved Method for the Electrical and Photometric Measurements of Solid-State Lighting Products.
2. Wattage: controlled to within 5%
3. Correlated Color Temperature: within specs as defined in ANSI\_NEMA\_ANSI C78.377-2008: Specifications for the Chromaticity of Solid State Lighting Products.



© 2019 Signify Holding. All rights reserved. The information provided herein is subject to change, without notice. Signify does not give any representation or warranty as to the accuracy or completeness of the information included herein and shall not be liable for any action in reliance thereon. The information presented in this document is not intended as any commercial offer and does not form part of any quotation or contract, unless otherwise agreed by Signify. All trademarks are owned by Signify Holding or their respective owners.

Signify North America Corporation  
200 Franklin Square Drive,  
Somerset, NJ 08873  
Telephone 855-486-2216

Signify Canada Ltd.  
281 Hillmount Road,  
Markham, ON, Canada L6C 2S3  
Telephone 800-668-9008