

DigiTrace CONTROL AND MONITORING



This section provides complete information for the design and selection of heat-tracing control and monitoring systems. Part 1 identifies control and monitoring options for use with heat-tracing applications. Part 2 details each Pentair Thermal Management control and monitoring product. For additional information contact your Pentair Thermal Management representative or visit our web site at www.pentairthermal.com.

Contents

Introduction	1
Product Overview.	2
Thermostats	2
Controllers	2
Control and Monitoring Systems.	3
Control Solutions.	5
Control Considerations.	5
Application Temperature Range	6
Control Options.	7
Control Selection	8
Monitoring Solutions.	12
Types of Monitoring	12
Monitoring Selection.	17
Additional Considerations	20
Pentair Thermal Management Control and Monitoring Systems	21
Microprocessor-Based Controllers	22
Multipoint Control and Monitoring Systems.	22
Single- and Dual-Point Control and Monitoring Systems	26
Thermostats.	28
Ambient-Sensing Thermostats	28
Line-Sensing Thermostats	28
Temperature Sensors	30
DigiTrace RMM2 (Remote Monitoring Module).	30
DigiTrace PLI (Power-Line Carrier Interface).	30
DigiTrace SES Transmitter (Smart End Seal).	31
DigiTrace RTDs.	31

Part 1: Control and Monitoring Options

INTRODUCTION

Pentair Thermal Management provides a wide variety of control and monitoring products, from simple mechanical thermostats and signal lights to sophisticated digital controllers and control and monitoring systems designed specifically for use with our heat-tracing products. This section will help you select and specify the right control and monitoring products for your application. For details on DigiTrace panel products such as the HTPG and HTPI, refer to Heat-Trace Panels (H56890).

PRODUCT OVERVIEW

DigiTrace control and monitoring products include thermostats, controllers, and control and monitoring systems. Following are descriptions of some of our most common control and monitoring products.

Thermostats

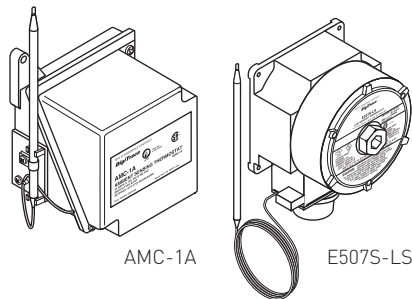

AMC-1A

E507S-LS

MECHANICAL THERMOSTATS

Mechanical thermostats, such as the ambient-sensing AMC-1A and line-sensing E507S-LS, provide cost-effective control for self-regulating and constant-wattage heat-tracing applications in both nonhazardous and hazardous locations.

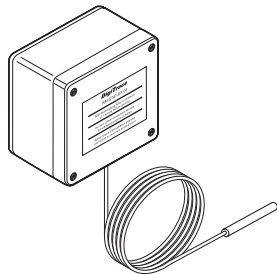

RAYSTAT-EX-03-A

ELECTRONIC THERMOSTATS

Electronic thermostats, such as the RAYSTAT-EX-03-A, offer additional features, including precise set points and long-lasting switches.

Controllers

ELECTRONIC CONTROLLERS

Electronic controllers include the JBS-100-ECP-A, JBS-100-ECW-A, and the DigiTrace 910 and 920 controllers.

JBS-100-ECP-A and JBS-100-ECW-A

The JBS-100-ECP-A and JBS-100-ECW-A are electronic temperature controllers that provide accurate control of a heating circuit using a RTD sensor. The JBS-100-ECP-A is pipe mounted and serves as a power connection kit for both Raychem self-regulating, power-limiting, and Pyrotenax mineral insulated heating cables. The JBS-100-ECW-A is wall mounted and may be used to control all types of heating cables. The JBS-100-ECW-A can only be used as a power connection with Pyrotenax mineral insulated cables. Combining the power connection and controller into one single unit will significantly reduce installation cost. Both the JBS-100-ECP-A and JBS-100-ECW-A have adjustable set points between 32°F to 425°F (0°C to 218°C), power input of 120 Vac to 277 Vac, and switches current up to 30 A. A local display allows for monitoring of set point, actual temperature, and also indicates alarm conditions (high/low temperature and sensor failure). A form C contact allows for remote annunciation of alarms. These units are c-CSA-us (certified to U.S. and Canadian Standards) for use in nonhazardous locations.

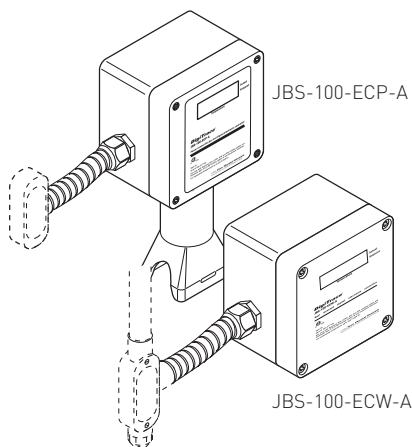

JBS-100-ECP-A

JBS-100-ECW-A

DigiTrace 910 and 920

The DigiTrace 910 and 920 controllers are microprocessor-based, single-point and dual-point controllers for heat-tracing circuits located in nonhazardous or Division 2 hazardous locations. These controllers combine the temperature control of a thermostat with integral ground-fault protection, while providing alarms for low and high temperatures, line current, and ground-fault current. Operation, programming, circuit status, currents, and temperatures are provided at the control panel and remotely by means of a network connection to the plant DCS or a PC with DigiTrace Supervisor software.

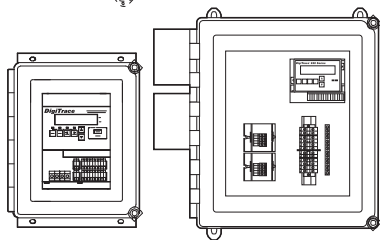

DigiTrace 910

DigiTrace 920

Control and Monitoring Systems

MULTIPOINT CONTROL AND MONITORING SYSTEMS

Multipoint control and monitoring systems include the DigiTrace NGC-30, and NGC-40 systems.

DigiTrace NGC-30

The DigiTrace NGC-30 is a distributed architecture control and monitoring system that can manage up to 260 heat-tracing circuits. Approved for use in both hazardous and nonhazardous areas, it allows user selection of several control modes, temperature setpoints and all alarm thresholds of individual heat-tracing circuits. During operation it monitors temperatures, ground-fault currents, operating currents and voltages and provides alarms via local indicators and remotely using dry contact relay outputs or through the DigiTrace Supervisor software. The DigiTrace NGC-30 system utilizes a touch screen-based user interface terminal for programming and monitoring at the panel. This user interface terminal provides an intuitive interaction with the control and monitoring system which allows users to quickly and easily access heat-tracing system information. Alarm information is communicated in plain language rather than codes.

Temperature inputs are provided through directly connected RTDs, through a Remote Monitoring Module (RMM2) or through a Power Line Carrier Interface (PLI) Module with special transmitters. Operation, programming, circuit and RTD status and alarm reporting are provided at the control panel or remotely via a network connection to the plant DCS or the DigiTrace Supervisor software.

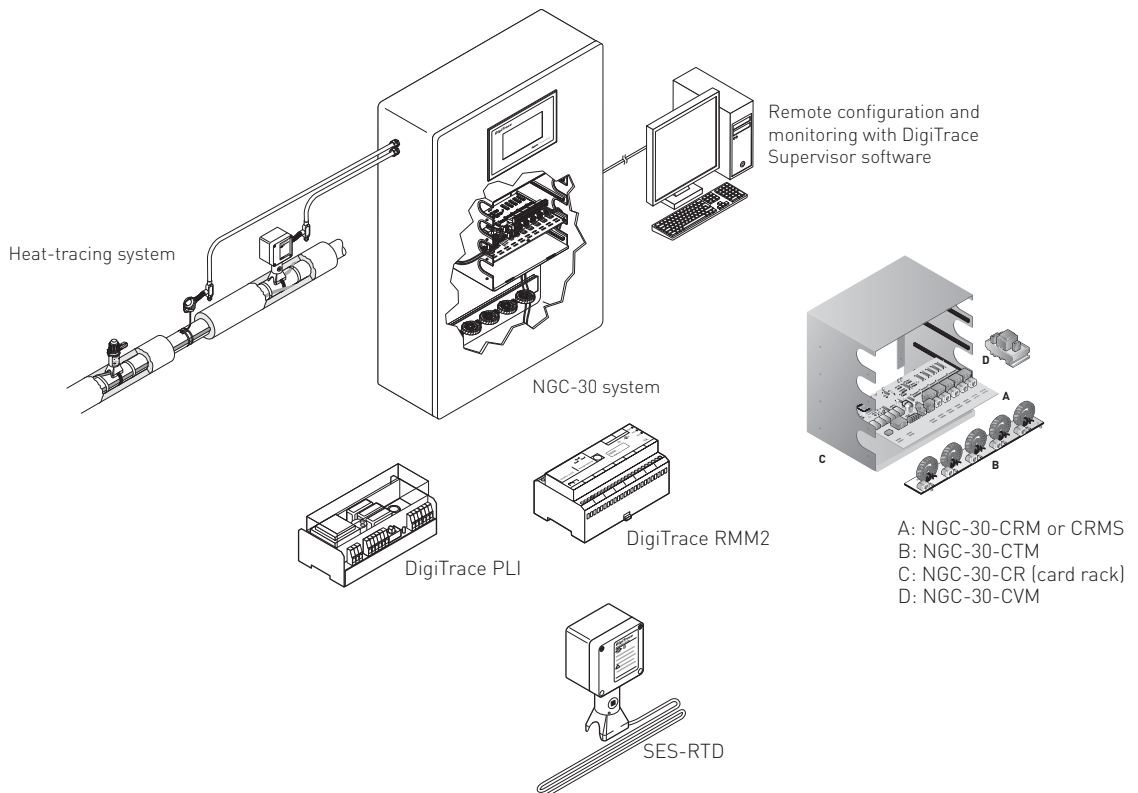

DigiTrace NGC-40

The NGC-40 control and monitoring system differs from the NGC-30 in that it dedicates a single control module to each individual heat-trace circuit. It provides the highest reliability for heat tracing applications based on single controller architecture. The DigiTrace NGC-40 control system offers a truly modular heat-tracing control, monitoring and power distribution system. NGC-40 modules are packaged in DIN Rail housing and are installed in an NGC-40 panel that can manage up to 80 heat tracing circuits. Operation, programming and easy intuitive access to the heat tracing data can be achieved locally at the control panel from a 15" touch screen (TOUCH 1500) or remotely from a central location using DigiTrace Supervisor software. The system is fully flexible from a configuration point of view and offers individual single-phase and three-phase electrical heat-tracing control and monitoring.

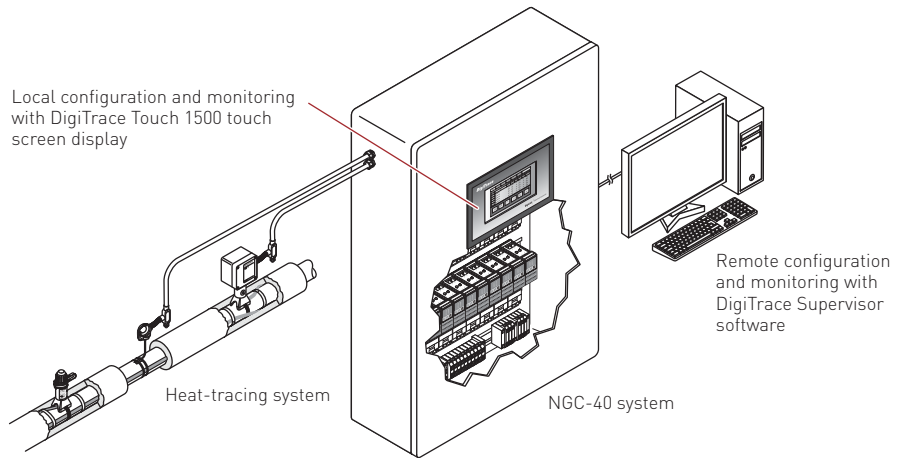
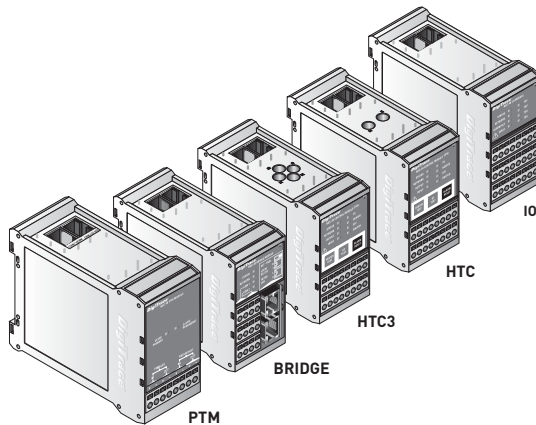

CONTROL SOLUTIONS

Control products vary the output of the heating source to keep pipes from freezing or to maintain process piping at elevated temperatures. The choice of control product depends on whether the system is controlled on the basis of ambient temperature or pipe temperature.

Most heat-tracing systems use a control element.

Applications that may benefit from a control element are those:

- Requiring a narrow operating temperature range.
- With temperature-sensitive fluids or equipment.
- For which energy consumption is a key concern.

Control Considerations

The most important step in providing a reliable control system is to design the heat-tracing system properly for the specific application.

Heat-tracing systems maintain the temperature of stagnant fluids in pipes and tanks by replacing the heat lost through the thermal insulation. Overall performance of the heat-tracing system is highly dependent on the integrity of the thermal insulation, the heat-tracing design, and the installation. Therefore, the most important step in providing a reliable control system is to properly design the heat-tracing system for the specific application, as detailed in other Pentair Thermal Management design guides.

When designing your heat-tracing system, consider these factors:

- Adding control elements increases the installation and maintenance costs of the system, but should result in tighter temperature control, energy savings and more efficient use of plant maintenance personnel's time.
- Electronic controllers increase initial system costs, but offer reliability and feedback superior to that provided by mechanical thermostats. The monitoring and alarm information available from electronic controllers can help maintenance personnel react to heat-tracing problems more quickly, before pipe freeze-up or process temperature issues cause a plant or process shutdown.
- The thermal environment of a heat-tracing system varies greatly — especially at valves, pipe supports, and other heat sinks — so it is seldom possible to achieve very tight temperature control.
- The temperature of a heat tracing system is based on ambient temperature and can vary by as much as 20°C when the system is uncontrolled. However, pipe temperature sensing will provide tighter temperature control than is possible with ambient sensing.
- TraceCalc Pro, Pentair Thermal Management design software, estimates the temperature range of your heat-tracing system, both with and without control. If an uncontrolled Raychem self-regulating heating cable provides an acceptable range, consider choosing this approach for its high reliability and low installed cost.

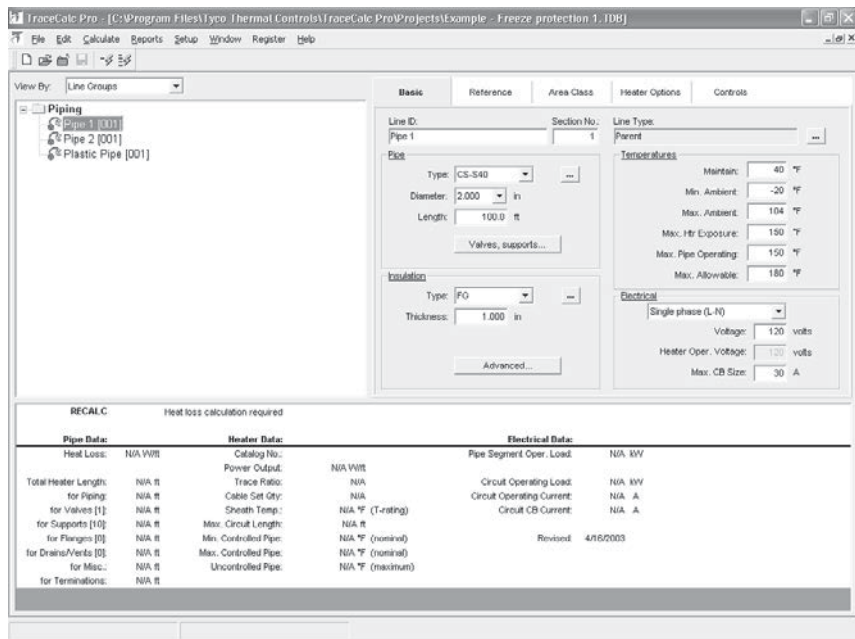

Fig. 1 TraceCalc Pro heat-tracing design software

Application Temperature Range

The options for control depend on the expected temperature range for the application. Ranges are grouped into three categories, as follows:

FREEZE PROTECTION

Freeze protection applies to fluids that must be kept above a minimum temperature, typically 32°F (0°C) for water lines. Moderate overheating of the fluid (30°F to 40°F; 17°C to 22°C) is not a major concern. (IEEE 515-2004, Process Type I)

BROAD TEMPERATURE MAINTENANCE

Broad temperature maintenance is appropriate when the process temperature must be controlled within a moderate range; e.g., set point plus approximately $\Delta T = \pm 35^\circ\text{F} \pm (19^\circ\text{C})$. This is generally used for viscosity control to keep process fluids flowing, such as in fuel oil and cooking oil lines. (IEEE 515-2004, Process Type II)

NARROW TEMPERATURE MAINTENANCE

Narrow temperature maintenance applies to fluids that must be kept within a narrow temperature range to maintain viscosity and prevent fluid or pipe degradation. Examples include sulfur and acrylic acid lines, as well as food syrup and sugar solutions. (IEEE 515-2004 Process Type III)

Control Options

The control method you select will be driven by your application. Table 1 summarizes the recommended control options for each application type. Following the table is an overview of the three basic control types: ambient-sensing, proportional ambient-sensing (PASC), and line-sensing control.

TABLE 1 RECOMMENDED CONTROL METHODS

Application	Control methods recommended
Freeze protection	Ambient-sensing control to reduce energy consumption Proportional ambient-sensing control (PASC) for lowest energy consumption
Broad temperature maintenance	Proportional ambient-sensing control (PASC) for tighter temperature control
Narrow temperature maintenance	Line-sensing control

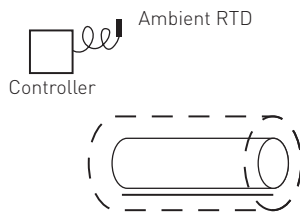
**AMBIENT-SENSING CONTROL**

Ambient-sensing control uses an on-off thermostat that senses ambient temperature. It is more energy efficient than self-regulating control because the heating circuit is energized only when the temperature drops below the setpoint. This type of control is most suitable for freeze-protection applications. The control device can be either a mechanical thermostat or an electronic controller. Mechanical thermostats are more commonly used since they are less expensive and are sufficiently accurate and reliable. However, they do not provide the monitoring and alarm functions that are available from an electronic controller.

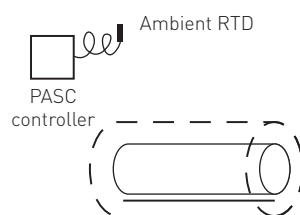
**PROPORTIONAL AMBIENT-SENSING CONTROL (PASC)**

Proportional ambient-sensing control (PASC) uses an electronic controller that senses ambient temperature and continuously matches the heat-tracing power applied to the pipe to the predicted heat loss that occurs due to changing ambient conditions. A preprogrammed algorithm calculates the cycle time that the heating circuits will be energized in order to maintain the desired temperature. This control method results in tighter temperature range control and lower energy usage than the ambient-sensing method. PASC control is suitable for all broad temperature-control and some narrow temperature-control applications, as well as freeze-protection applications.

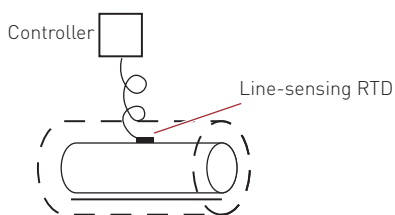
**LINE-SENSING CONTROL**

Line-sensing control is based on pipe temperature. With this option, each flow path must have a separate circuit controlled by a mechanical line-sensing thermostat or electronic controller. When the pipe temperature falls below the desired maintain temperature, the control unit turns on the heating circuit. The same cost-benefit trade-offs between electronic and mechanical controllers should be made for line-sensing applications. An electronic controller with monitoring and alarm features is recommended for critical pipes.

CONTROL AND MONITORING

Control Selection

Selecting a control system suitable for your application involves four steps:

- 1** Select the Pentair Thermal Management heat-tracing solution.
- 2** Identify the control application.
- 3** Choose the control method.
- 4** Review the specifications for your control selection.

The selection process outlined on the following pages results in a reliable, cost-effective control system optimized for simplicity. If you are installing multiple heat-tracing circuits, a more detailed analysis of the application may yield a different result with lower installed and operating costs. Contact your Pentair Thermal Management representative for assistance.

Control Selection	Step 1 Select the Pentair Thermal Management heating solution
1. Select Pentair Thermal Management heating solution	<p>This is the most important step in designing a heat-tracing system. Use the heat-tracing product selection sections in this publication to select the heating system and components for your application. Assistance is available on-line (www.pentairthermal.com), in Pentair Thermal Management TraceCalc Pro design software, or from your Pentair Thermal Management representative.</p>
2. Identify control application	
3. Choose control method	
4. Review specifications for control selection	

Control Selection	Step 2 Identify the control application								
1. Select Pentair Thermal Management heating solution	<p>For the pipes and tanks to be heated, identify the specific control application in Table 2</p> <p>TABLE 2 CATEGORIES OF CONTROL</p> <table border="1" style="width: 100%; border-collapse: collapse;"> <thead> <tr> <th style="background-color: #f2f2f2;">Control application</th> <th style="background-color: #f2f2f2;">Temperature range/goal</th> </tr> </thead> <tbody> <tr> <td style="background-color: #f2f2f2;">Freeze protection</td> <td style="background-color: #f2f2f2;">To keep water lines above 32°F (0°C)</td> </tr> <tr> <td style="background-color: #f2f2f2;">Broad temperature control</td> <td style="background-color: #f2f2f2;">For viscosity control to keep process fluids flowing</td> </tr> <tr> <td style="background-color: #f2f2f2;">Narrow temperature control</td> <td style="background-color: #f2f2f2;">To keep process fluids within a narrow temperature band to maintain viscosity and prevent fluid degradation</td> </tr> </tbody> </table>	Control application	Temperature range/goal	Freeze protection	To keep water lines above 32°F (0°C)	Broad temperature control	For viscosity control to keep process fluids flowing	Narrow temperature control	To keep process fluids within a narrow temperature band to maintain viscosity and prevent fluid degradation
Control application		Temperature range/goal							
Freeze protection		To keep water lines above 32°F (0°C)							
Broad temperature control		For viscosity control to keep process fluids flowing							
Narrow temperature control	To keep process fluids within a narrow temperature band to maintain viscosity and prevent fluid degradation								
2. Identify control application									
3. Choose control method									
4. Review specifications for control selection									

If your project includes multiple heat-tracing circuits and a combination of applications, or monitoring and alarm reporting capability is desired, use the DigiTrace NGC-30 or NGC-40 control and monitoring system and contact your Pentair Thermal Management representative for design assistance. Otherwise, continue to Step 3 to select your control method.

Control Selection
1. Select Pentair Thermal Management heating solution
2. Identify control application
3. Choose control method
4. Review specifications for control selection

Step 3 Choose the control method**FOR FREEZE-PROTECTION APPLICATIONS**

Use Table 3 to select the appropriate control solution for your application. Base your selection on the number and type of heat-tracing circuits to be installed, the type of control you need, and the area classification. Other Pentair Thermal Management products that include monitoring and ground-fault protection are discussed later under "Monitoring Solutions."

TABLE 3 CONTROL SELECTION FOR FREEZE PROTECTION

Pentair Thermal Management heating solution: individual circuits ¹	Control options	DigiTrace control product	Quantity required
Self-regulating heating circuits on pipes	Ambient-sensing control	AMC-1A, AMC-1H, JBS-100-ECP-A, or JBS-100-ECW-A	One per circuit
Constant-wattage/power-limiting heating circuit(s) on pipes (includes MI and VPL cables)	Line-sensing control	AMC-1B, E507S-LS, 910, 920, JBS-100-ECP-A, or JBS-100-ECW-A	One per circuit
Any heating circuit(s) on tanks	Line-sensing control	AMC-1B, E507S-LS, 910, 920, JBS-100-ECP-A, or JBS-100-ECW-A	One per circuit
Multiple circuits¹ grouped in panels			
Self-regulating heating circuits on pipes	Ambient-sensing control	HTPG, HTPI	One per system
	Energy-saving electronic proportional control	NGC-30, NGC-40, 920	One per system
Constant-wattage/power-limiting heating circuits on pipes	Proportional control for each contactor in panel	NGC-30, NGC-40, 920	One per system
Any heating circuits on tanks	Multicircuit line-sensing control	NGC-30, NGC-40, 920	One per system

1. A heat-tracing circuit is defined as one circuit breaker with its associated branch wiring, heat-tracing cable, and components.

FOR BROAD TEMPERATURE CONTROL APPLICATIONS

Use Table 4 to select the appropriate control solution for your application. Base your selection on the number and type of heat-tracing circuits you will use in your application, the desired control option, and the area classification. Other Pentair Thermal Management products that include monitoring and ground-fault protection are discussed later under “Monitoring Solutions.”

TABLE 4 CONTROL SELECTION FOR BROAD TEMPERATURE CONTROL

Pentair Thermal Controls heating solution: individual circuits¹	Control options	DigiTrace control product	Quantity required
Self-regulating heating circuits on pipes	Line-sensing control	AMC-1B, E507S-LS, JBS-100-ECP-A, or JBS-100-ECW-A	One per circuit
Constant-wattage/power-limiting heating circuits on pipes (includes MI, SC and VPL cables)	Line-sensing control for each circuit; maintain temperature less than 300°F (150°C)	AMC-1B, E507S-LS, JBS-100-ECP-A, or JBS-100-ECW-A	One per circuit
	Line-sensing control for each circuit; maintain temperature greater than 300°F (150°C)	RAYSTAT-EX-03-A, JBS-100-ECP-A, or JBS-100-ECW-A 910, 920	One per circuit
Any heating circuit(s) on tanks	Line-sensing control	AMC-1B, E507S-LS, JBS-100-ECW-A or 910, 920	One per circuit
Multiple circuits¹ grouped in panels			
Any heating circuits on pipes	Multicircuit proportional ambient-sensing control (PASC) ²	NGC-30, NGC-40	One per system
	Multicircuit line-sensing control	NGC-30, NGC-40, 920	One per system
Any heating circuits on tanks	Multicircuit line-sensing control	AMC-1B, E507S-LS, NGC-30, NGC-40, 920	One per system

1. A heat-tracing circuit is defined as one circuit breaker with its associated branch wiring, heat-tracing cable, and components.
2. The DigiTrace NGC-30, NGC-40, 920 and 910 controllers include approved ground-fault protection, so a ground-fault circuit breaker in the panel is not required.

FOR NARROW TEMPERATURE CONTROL APPLICATIONS

Use Table 5 to select the appropriate control solution for your application. Base your selection on the number and type of heat-tracing circuits you will use in your application, the desired control option, and the area classification. Other Pentair Thermal Management products that include monitoring and ground-fault protection are discussed later under “Monitoring Solutions.”

TABLE 5 CONTROL SELECTION FOR NARROW TEMPERATURE CONTROL

Pentair Thermal Management heating solution: individual circuits¹	Control options	DigiTrace control product	Quantity required
Heating circuits on pipes or tanks	Line-sensing control for each circuit; maintain temperature less than 300°F (150°C)	AMC-1B, E507S-LS, 910, 920, JBS-100-ECP-A, or JBS-100-ECW-A	One per circuit
	Line-sensing control for each circuit; maintain temperature greater than 300°F (150°C)	RAYSTAT-EX-03-A, JBS-100-ECP-A, JBS-100-ECW-A or 910, 920	One per circuit
Multiple circuits¹ grouped in panels			
Any heating circuits on pipes	Multicircuit line-sensing control	NGC-30, NGC-40 or 920,	One per system
Any heating circuits on tanks	Multicircuit line-sensing control	NGC-30, NGC-40, 920	One per system

1. A heat-tracing circuit is defined as one circuit breaker with its associated branch wiring, heat-tracing cable, and components.

Control Selection
1. Select Pentair Thermal Management heating solution
2. Identify control application
3. Choose control method
4. Review specifications for control selection

Step 4 Review the specifications for your control selection

You will find descriptions of each of the control products in Control and Monitoring, Part 2; data sheets for these products are available on the Pentair Thermal Management web site. Review the technical specifications of each product you have selected to ensure the product meets the needs of your application.

MONITORING SOLUTIONS

While you may select only one method of control for each heat-tracing circuit, you may incorporate a variety of monitoring options into the system design. The use of monitoring increases overall system reliability because failures in the heating and power distribution systems get reported to operations personnel.

Pentair Thermal Management recommends always using, at a minimum, ground-fault monitoring. For the small additional cost, you get a monitoring system that reliably reports physical damage to the heat-tracing system, which is a common failure mode.

For critical applications, add temperature and/or current monitoring. This technique gives the most direct feedback on system performance. Multiple sensors can be placed at critical components.

To bring monitoring and alarm reporting from all heat-tracing circuits, use DigiTrace Supervisor software located in the control or operations room.

Types of Monitoring

Monitoring increases system reliability by detecting faults before they become a major problem.

There are several methods available for monitoring heat-tracing systems. Local and remote feedback can be provided on ground-fault levels, pipe temperatures, heating cable current, and continuity.

GROUND-FAULT MONITORING

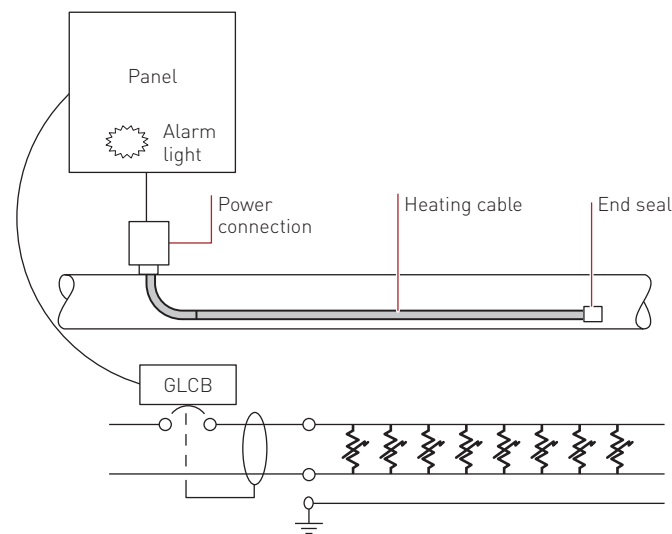

Fig. 2 Ground-fault monitoring: GLCB status

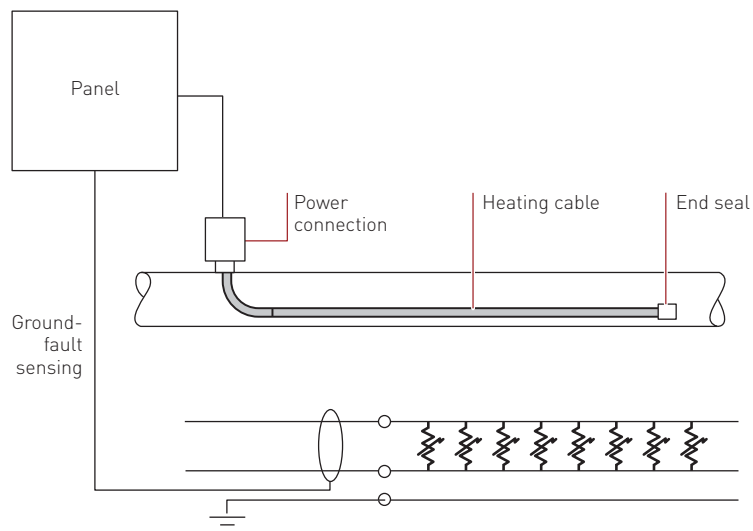

Fig. 3 Ground-fault monitoring of actual G-F current

A ground-fault monitoring system monitors the current leakage from the heating system (heating cable, power wiring, and components) to ground, using ground-leakage circuit breakers and/or current-sensing devices that measure the current. Standard circuit breakers do not provide adequate protection because they are not designed to detect the low-level ground-fault currents that may be produced as a result of improper installation or mechanical damage.

National electrical codes and other local codes require ground-fault equipment for heat-tracing circuits. These protective devices are designed to reduce the risk of fire and to safeguard equipment, rather than personnel. Ground-fault interrupters (GFIs) specified for personnel protection normally have a 4-mA to 6-mA trip setting that may lead to frequent nuisance tripping in heat-tracing applications.

When a heat-tracing circuit's current leakage exceeds the trip setting, the protective device trips, shutting off the circuit. If the protective device is a Ground Leakage Circuit Breaker (GLCB), it may have an auxiliary (bell alarm) contact to trigger a common remote trip alarm. Other protective devices can also trigger alarms, as well as interrupt the circuit.

Alarms and trips are usually caused by improper installation, mechanical damage to the heating cable or power wiring, or moisture in junction boxes or end seals. Since these are typically accompanied by ground-fault current, ground-fault detection provides a significant monitoring function for electrical heat tracing.

Strengths of ground-fault monitoring

Strengths of ground-fault monitoring include:

- Quick detection of potentially dangerous fault conditions due to improper installation, mechanical damage, or water ingress.
- Easy grouping and wiring of alarms to a remote location.

Pentair Thermal Management provides a range of ground-fault sensors and equipment-protection GFIs, which provide CSA and UL-approved ground-fault current protection for heating circuits.

TEMPERATURE MONITORING

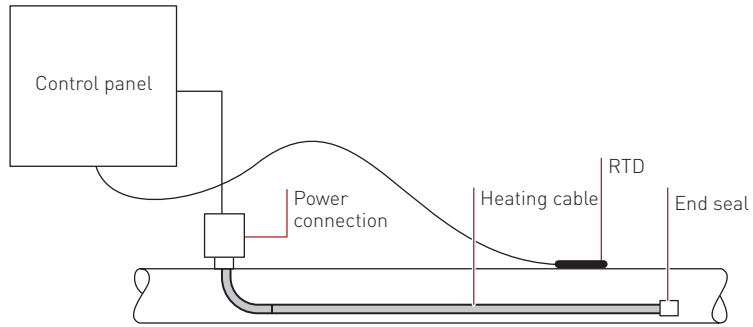

Fig. 4 Temperature monitoring

Temperature monitoring systems continuously measure the pipe or tank temperature and signal an alarm if preset limits are exceeded. A digital controller uses an RTD temperature sensor placed on the pipe or tank to check the pipe temperature against the low and high limits, which are typically set 20°F (10°C) above and below the normal control range of the circuit.

Low-temperature alarms

One or more of the following conditions can cause a low-temperature alarm:

- Loss of power to the heating cable.
- Wet or missing thermal insulation.
- Heating cables with insufficient power output.
- Control failure, or controller left in OFF position.
- Heating cable failure.

High-temperature alarms

High-temperature monitoring is typical in applications such as safety showers, plastic pipes and tanks, and processes in which an overtemperature condition can adversely affect the fluid properties. Any of the following conditions can cause a high-temperature alarm:

- Fluid temperature that exceeds the alarm limit, such as during steam-cleaning operations.
- Controller failure or controller left in the ON position.
- A site installation condition that differs from the design parameters; e.g., oversized insulation.

Strengths of temperature monitoring

Following are the primary advantages of temperature monitoring:

- Dedicated to monitoring pipe temperature, the most critical aspect of heat tracing.
- Effective for monitoring failures in other systems, including thermal insulation, design, and process.
- Relatively simple to apply in any environment, with any heating system, and at any location.
- Provides timely indication of fault condition allowing repairs to be implemented before costly shutdowns or catastrophic mechanical failures occur.

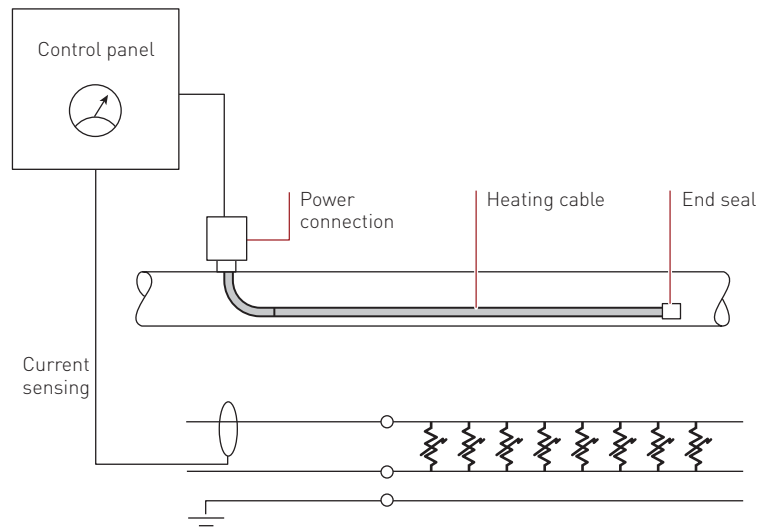
CURRENT MONITORING**Fig. 5 Current monitoring**

Current monitoring uses a heat-tracing controller or current-monitoring relay to signal an alarm when electrical current in the circuit is too low or too high. This monitoring method is especially effective for constant-wattage heating products because their current usually does not vary over time or temperature.

The current flowing in self-regulating cables will vary significantly based on the heating requirements of the pipe at a particular moment in time. Therefore, current monitoring is only effective at identifying short or open conditions for self-regulating cable.

The following conditions typically cause an alarm from a current-monitoring system:

- Loss of power to the heating cable, or a tripped circuit.
- Damage to the heating cable bus wires or branch-circuit wiring.
- Splices or tees left open after repair or maintenance.

Strengths of current monitoring

Strengths of current monitoring include the following:

- Alarms from current monitors can be grouped in a central location.
- Power loss to the heating system is reported.
- Unpowered sections of heat-tracing cables will result in low-current alarms.

DigiTrace 910 single-point controller, 920 dual-point controller, NGC-30, and NGC-40 systems offer current monitoring with low and high alarm settings and remote annunciation.

CONTINUITY MONITORING

Continuity monitoring is a technique used to verify that the heating-cable circuit has voltage present at the far end (termination end). Continuity monitoring is often provided by a signal light installed as part of the end seal, which provides a local visual indication of voltage presence at the end of the heating-cable circuit. This equipment is called an end-of-circuit light (E-100-L-A). For remote or centralized verification that voltage is present, a transmitter can be incorporated as part of the end termination. The transmitter communicates with a centralized receiver at the near end of the circuit and confirms continuity. This equipment is called an end-of-line transmitter (SES).

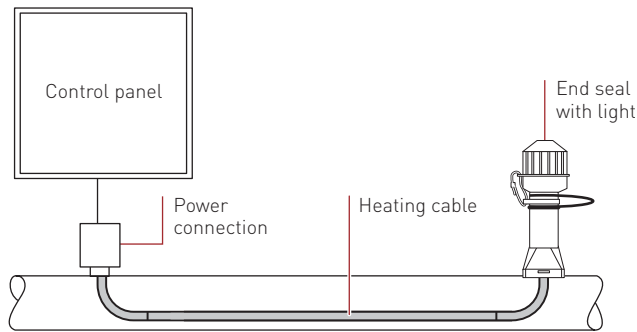

Fig. 6 Continuity monitoring with a signal light (end-of-circuit light)

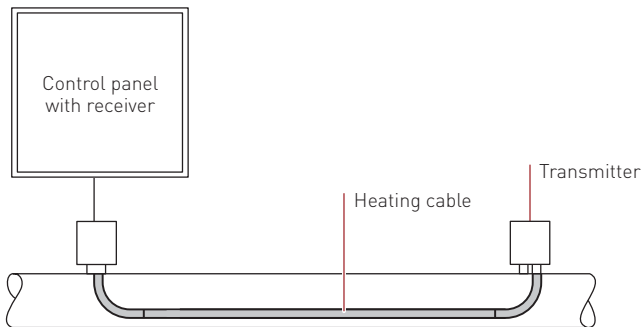

Fig. 7 Continuity monitoring with power line signal transmitter (end-of-line transmitter)

When continuity is not confirmed — either the signal light is off, or the message at the central receiver is negative — it can be due to:

- Loss of heating cable continuity; e.g., cable damaged, splice left open.
- Loss of power to the heating circuit; e.g., tripped breaker, failed thermostat, tripped ground-fault protection device.
- No call for heat from the control unit or thermostat.
- A defective light or transmitter.

Since a defective end-of-circuit light can lead to a false warning, all Pentair Thermal Management products use long-lasting, maintenance-free LED signal lights.

Strengths of continuity monitoring

Lighted End Seals have several key advantages:

- Low installed cost; adding a light to an end seal is inexpensive.
- Upgradable critical lines; lights can be retrofitted to existing end seals.
- Heat-tracing failure detection, including damaged cables and tripped breakers.
- Simplified troubleshooting; there is no need to open junction boxes or use contact test tools.
- Used in parallel circuits with good results.

The Raychem lighted end seal, the E-100-L-A, provides bright LED indication at a low installed cost.

A DigiTrace end-of-line transmitter product — Smart End Seal (SES) system — can provide power line signal transmission, giving centralized continuity confirmation at an attractive cost when used with the NGC-30 panels with PLI option.

Monitoring Selection

Selecting a monitoring method suitable for your application is a three-step process:

- 1** Select the control method.
- 2** Identify the monitoring application.
- 3** Choose the monitoring method.

As with heat-tracing control, monitoring is not always required. Choose the level of monitoring appropriate to the level of criticality of your process.

Monitoring Selection
1. Select control method
2. Identify monitoring application
3. Choose monitoring method

Step 1 Select the control method

Although control and monitoring choices can be made independently, in practice, the type of control solution you select influences your monitoring choice. For example, using the DigiTrace NGC-30 or NGC-40 system for control allows easy addition of temperature monitoring.

Monitoring Selection
1. Select control method
2. Identify monitoring application
3. Choose monitoring method

Step 2 Identify the monitoring application

The sophistication of the monitoring technique generally depends on the type of heat-tracing application. Choose your application from Table 6 as you did for control selection.

TABLE 6 CATEGORIES OF HEAT-TRACING APPLICATIONS

Application	Temperature range/goal
Freeze protection	To keep water lines above 32°F (0°C) (IEEE 515-2011 Process Type I)
Broad temperature control	For viscosity control to keep process fluids flowing (IEEE 515-2011 Process Type II)
Narrow temperature control	To keep process fluids within a narrow temperature band to maintain viscosity and prevent fluid degradation (IEEE 515-2011 Process Type III)

Monitoring Selection
1. Select control method
2. Identify monitoring application
3. Choose monitoring method

Step 3 Choose the monitoring method

FREEZE-PROTECTION APPLICATIONS

Use Table 7 to select the appropriate monitoring solution for your application. Base your selection on the number of heat-tracing circuits to be installed, the control method you've chosen, and the criticality of the process being protected. Examples of critical freeze-protection lines include process water feed lines, safety showers, and fire water lines.

TABLE 7 MONITORING SELECTION FOR FREEZE PROTECTION

Number of heat-tracing circuits	Control method	Criticality	DigiTrace monitoring method ¹	Quantity required
One or more individual heating circuits	Self-regulating (no control), ambient-sensing or line-sensing thermostat	Not critical	Ground-fault monitoring via GLCB	One GLCB per circuit
		Critical	Current temperature and ground-fault monitoring via 910 ² and 920 ²	One per every one (910) or two (920) circuits
Multiple circuits	Ambient-sensing, line-sensing, or energy-saving proportional control	Not critical	Ground-fault monitoring via GLCB	One GLCB per circuit with one common alarm for panel
		Critical	Current, temperature and ground-fault monitoring via NGC-30 or, NGC-40 ²	One per system

1. Add the E-100-L-A lighted end seal to any choice for easier troubleshooting.
2. Replace the mechanical or electronic thermostat you selected under "Control Selection" with this unit.

BROAD TEMPERATURE CONTROL APPLICATIONS

Use Table 8 to select the appropriate monitoring solution for your application. Base your selection on the number of heat-tracing circuits to be installed, the control method you've chosen, and the criticality of the process being traced. Criticality for broad temperature control generally means the system should alarm when pipe or tank temperature drops below a predetermined limit.

TABLE 8 MONITORING SELECTION FOR BROAD TEMPERATURE CONTROL

Number of heat-tracing circuits	Control method	Criticality	DigiTrace monitoring method ¹	Quantity required
One or more individual heat-tracing circuits	Self-regulating (no control), or line sensing thermostat	Not critical	Ground-fault monitoring via GLCB	One GLCB per circuit
		Critical	Current temperature and ground-fault monitoring via 910 ² and 920 ²	One per circuit
Multiple circuits	PASC or multicircuit line sensing control	Not critical	Ground-fault monitoring via GLCB with common alarm to controller	One GLCB per circuit
		Critical	Current, temperature and ground-fault monitoring via NGC-30 or NGC-40 ²	One per system

1. Add the E-100-L-A lighted end seal to any choice for easier troubleshooting.
2. Replace the mechanical or electronic thermostat you selected under "Control Selection" with this unit.

NARROW TEMPERATURE CONTROL APPLICATIONS

Use Table 9 to select the appropriate monitoring solution for your application. Base your selection on the number of heat-tracing circuits to be installed and the control method you've chosen. All narrow control applications are considered critical.

TABLE 9 MONITORING SELECTION FOR NARROW TEMPERATURE CONTROL

Number of heat-tracing circuits	Control method	Criticality	DigiTrace monitoring method ¹	Quantity required
One or more individual heating circuits	Line sensing thermostat	Critical	Temperature monitoring via 910 ² or 920 ²	One per circuit
Multiple circuits	Multicircuit line sensing control	Critical	Temperature monitoring via NGC-30 or NGC-40 ²	One per system

1. Add the E-100-L-A lighted end seal to any choice for easier troubleshooting.
2. Replace the mechanical or electronic thermostat you selected under "Control Selection" with this unit.

CONTROL AND MONITORING

Additional Considerations

The selection tables in this section provide control and monitoring solutions for the majority of heat-tracing applications. Review the following additional considerations and discuss any unusual applications or requirements with your Pentair Thermal Management representative.

If your design selection includes a mechanical thermostat and ground-fault circuit breaker for each heat-tracing circuit, consider instead using the DigiTrace 910 single-point controller or 920 multipoint controller. These replace both the mechanical thermostat and the ground-fault circuit breaker, and provide temperature, ground-fault, and current monitoring in a rugged industrial package.

If multiple heat-tracing circuits are to be installed at the same time, there are significant opportunities for installation, operation, and maintenance cost savings. Pentair Thermal Management representatives can help optimize your system by choosing the best combination of heat-tracing products and control and monitoring systems.

If you plan to connect your heat-tracing control and monitoring equipment to a host computer or DCS in your facility, consider the DigiTrace 910, 920, NGC-30 or NGC-40. All offer extensive networking capabilities, as well as computer-based DigiTrace Supervisor software.

If your application requires long runs of temperature-sensor cable or conduit, consider a DigiTrace NGC-30 system with power-line interface modules (PLIs) or the NGC-30 with the RMM2. The NGC-30 line sensing control and temperature monitoring system with the PLI transmits temperature data over the heating cable bus wires and branch circuits, significantly reducing the cost of temperature sensor cable or conduit runs.

The RMM2 is an 8-point RTD module located in the field. Up to 16 RMM2 modules can be connected together via RS485 twisted pair cable back to the NGC-30 or NGC-40 controller.

Part 2: Control and Monitoring Systems

PENTAIR THERMAL MANAGEMENT CONTROL AND MONITORING SYSTEMS

Compare features of Pentair Thermal Management control and monitoring systems in Table 10. For additional information on each product, see the descriptions that follow and the data sheets.

TABLE 10 PENTAIR THERMAL MANAGEMENT CONTROL AND MONITORING PRODUCTS

	Thermostats		Controllers				
	Ambient	Line	DigiTrace NGC-30	DigiTrace NGC-40	DigiTrace 910 / 920	JBS-100- ECP-A / JBS-100- ECW-A	RAYSTAT EX-03-A
Control							
Ambient-sensing	•		•	•	•	•	
Line-sensing		•	•	•	•	•	•
PASC			•	•	•		
RTD input			•	•	•	•	•
Monitoring							
Ambient temperature			•	•	•	•	
Pipe temperature			•	•	•	•	•
Ground fault			•	•	•		
Continuity			•				
Current			•	•	•		
Location							
Local	•	•	•	•	•	•	•
Remote			•	•		JBS-100- ECW-A only	
Hazardous	•	•	•	•	•		•
Communication							
Local display			•	•	•	•	
Remote display			•	•	•		
Network DCS			•	•	•	•	
DigiTrace Supervisor			•	•	•		

MICROPROCESSOR-BASED CONTROLLERS

These electronic systems are designed to control heating-cable circuits used in freeze protection and process-temperature maintenance applications. Each has unique features that provide cost-effective temperature control and extensive heat-tracing circuit integrity monitoring. All offer digital displays, simple push-button configuration, and intelligent communications to remote PCs or a DCS. Choose the DigiTrace 910 for single heat-tracing circuits, the DigiTrace 920 for dual heat-tracing circuits, DigiTrace NGC-30 or NGC-40 for multiple heat-tracing circuits.

Multipoint Control and Monitoring Systems

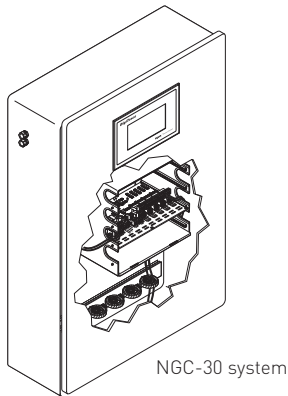

DIGITRACE NGC-30 SYSTEM

The DigiTrace NGC-30 system is a next generation heat-tracing control and monitoring system using state-of-the-art electronics and a touch screen user interface terminal to reduce training and greatly increase ease of use. Able to control up to 260 heat-tracing circuits, the NGC-30 provides independent circuit monitoring, programming and fault reporting for maximum system flexibility. Faults and alarms are communicated in plain text via the touch screen user interface terminal, enhancing usability and reducing troubleshooting time.

Compatible with Ethernet, RS-485 and RS-232 communications, the NGC-30 system can be easily integrated into existing plant networks. DigiTrace Supervisor software can be used to provide remote or centralized access to the NGC-30 System and establish a stand-alone heat-tracing control point. The NGC-30 communicates to external systems via the Modbus protocol if compatibility with existing DCS systems is desired.

The DigiTrace NGC-30 is available with both electromechanical or solid-state relays and is approved for both hazardous and nonhazardous locations.

Control

The DigiTrace NGC-30 measures temperatures with 3-wire, 100-ohm platinum RTDs. The temperature information can be transferred to the NGC-30 control panel through an RTD directly connected to the NGC-30 panel, through an optional Remote Monitoring Module (RMM2) or through an optional PLI Module with special transmitters: DigiTrace SES (Smart-End-Seal), DigiTrace SPC (Smart Power Connection). Each RMM2 aggregates up to 8 RTDs in the field. The RMM2 and PLI modules communicate temperature data back to the NGC-30 system via a single RS-485 twisted wire pair.

Power Line Carrier Interface Technology

The DigiTrace Power Line carrier Interface Module (PLI) is an optional part of the DigiTrace NGC-30 heat-tracing control and monitoring system. When using Power Line Interface Technology (PLI), the RTD temperature information and the continuity confirmation are sent back through special transmitters, SES/SPC, to the PLI Module and the NGC-30 controller along the heat-tracing bus wires and the AC power line, meaning the heating cable is also the data cable. Since no additional wiring is required to bring RTD temperature and continuity data back to a central location, installation and maintenance costs of the heat-tracing system are significantly reduced.

Monitoring

The DigiTrace NGC-30 system measures 12 parameters including ground-fault, temperature and current variables to ensure system integrity. The DigiTrace NGC-30 units can monitor up to 16 RMM2s that each have inputs for eight temperature sensors (RTD). The RMM2s can be connected by a single RS-485 cable to the NGC-30, thus reducing wiring costs for temperature sensors. Power line carrier communication can further reduce wiring costs because the heat-tracing bus wires and the AC power lines carry the temperature information signal back to a PLI, which interfaces with the NGC-30 controller. This eliminates the need for RTD wiring

or field RS-485 cable. Three (3) dry contact alarm relays are provided for remote alarm indications if desired. The system allows configuration of what fault types cause relay state change. For example, one relay could be configured to indicate only when a ground-fault alarm exists, another only in response to a temperature alarm and the third for over current and communications and RTD sensor failures. The system can be set to periodically check for heating cable faults when conditions do not require the heat tracing to be energized for extended periods. If a problem occurs, maintenance personnel will be notified and the issue can be repaired before it effects plant operation.

Benefits and Features

- Optimized control mode for each individual heat-tracing circuit. Each of the 260 heat-tracing circuits can be set to one of five control algorithms independently of the setting of any other heat-tracing circuits. There are no global settings at the circuit level.
- Central status overview and access to all parameters of the entire heat-tracing installation through the touch screen user interface terminal. This intuitive interface reduces training time and provides simple and easy navigation so that maintenance and operations personnel can retrieve the information they need quickly and without bulky reference manuals.
- Faults are communicated in plain language eliminating the need to remember or decipher fault codes.
- Alarms for temperatures, ground-fault currents, operating currents, communications, RTD status and others are all logged in an Events file to track system history. Information is easily accessible through the user interface terminal which also provides the ability to sort on the various fault types.
- Ground-fault alarm and trip thresholds are independently programmable to allow warning of a potential problem before a system shut-down is implemented. This allows the heat-tracing system to be checked at a convenient time with minimal impact to plant operations and hardship to personnel.
- Significant cost savings through distributed architecture and reduced RTD wiring (using the DigiTrace RMM2). Temperature input and control output modules can be placed at a convenient location.
- Supports power line carrier option to eliminate the need for separate RTD wiring, field communication cables and conduit installation costs.
- DigiTrace Supervisor (DTS) client-server software allows heat-tracing control to become an integral part of your Heat Management System. This software provides information and configuration capability at one central location making better use of personnel. Data logging for trending, fault finding and other analysis allows predictive maintenance when using the DigiTrace Supervisor (DTS) client-server software including automatic heat-tracing system integrity checks and many more features.
- LAN/WAN access allows control and monitoring from any location world-wide.

Other Features

- Passwords provide various levels of access for different user groups. This allows all necessary status and monitoring information to be viewed by anyone but restricts temperature setpoint and fault threshold changes to certified personnel.
- Rack mountable control cards are easily added and removed from the NGC-30 system panel. This allows fast and easy replacement in the case of a failure or the ability to expand the system as your facility grows.

CONTROL AND MONITORING

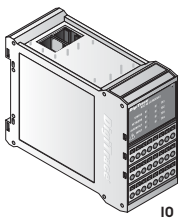
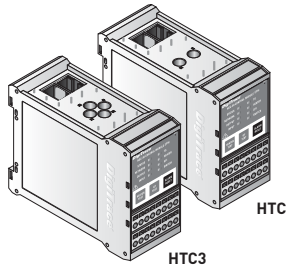
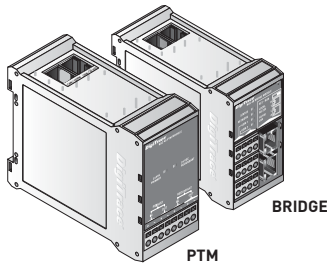

DIGITRACE NGC-40 SYSTEM

The DigiTrace NGC-40 is an advanced, electronic, single-point control, monitoring and power distribution system in a multipoint industrial heat-tracing panel. The single control module per heat-tracing circuit provides the highest reliability architecture for heat-tracing applications. The NGC-40 single-controller architecture ensures that problems occurring with one heat-tracing system stay isolated without affecting the other circuits. The advanced User Interface with touch screen technology simplifies local programming and monitoring through intuitive menus and full text alarm reporting.

The NGC-40 supports up to 80 circuits and provides maximum flexibility through its modular architecture to meet any need at an optimized cost. The NGC-40 is available with two output types: an electromechanical relay (EMR) or a solid state relay (SSR). The system is fully flexible from a configuration point of view and offers individual single-phase and three-phase electrical heat-tracing controllers.

The DigiTrace NGC-40 is supported by the innovative DigiTrace Touch 1500, a 15-inch color touch screen user interface which provides plant personnel with local, intuitive access to the complete control and monitoring system. The Touch 1500 allows for status, alarm and event monitoring of the heat-tracing circuits as well as the easy adjustment of the control and monitoring system to handle revised heat-tracing system configurations.

Full compatibility with the DigiTrace Supervisor (DTS) software allows not only control and monitoring but also data logging for trending, fault finding and other analysis allows predictive maintenance.

Control

The DigiTrace NGC-40 measures temperatures with 3-wire, 100-ohm platinum RTDs, 2 or 3-wire, 100-ohm nickel iron RTDs, or 2-wire, 100-ohm nickel RTDs. The temperature information may come from a single, direct RTD hard-wired to the NGC-40 control panel, from a local NGC-40 IO module, or from a remote source such as an RMM2 module. Up to eight (8) Resistance Temperature Devices (RTDs) can be used for each heat-tracing circuit allowing a variety of temperature control, monitoring, and alarming configurations. For RTD selection, see Table 11 DigiTrace RTD Selection Matrix.

Monitoring

The DigiTrace NGC-40 system measures a variety of parameters including ground-fault, temperature and load current(s) to ensure system integrity. In the case of three-phase heaters, the current of each phase can be separately measured and monitored. The system can be set to periodically check the heating cable for faults, alerting maintenance personnel of a pending heat-tracing problem, and avoiding costly downtime.

Features

- Each circuit is controlled by individual single-phase or three-phase controllers.
- Control and monitoring of up to 80 individual circuits per panel with multiple panels connected to one DigiTrace Touch 1500 user interface.
- The DigiTrace NGC-40 system is configured with a user interface, DigiTrace Touch 1500, that is a state-of-the-art 15-inch color display with touch screen technology for monitoring and configuration purposes. The DigiTrace Touch 1500 touch screen allows convenient user access on site to all heat-tracing circuits and provides an easy user interface for programming without keyboards or cryptic labels.
- Touch 1500 can be installed either locally on the panel door or in a remote location and communicates to the DigiTrace NGC-40 heat-tracing controllers via Ethernet or serial interface.

- I/O modules allow additional temperature and analog/digital signals to interface with the control modules. Up to 8 RTDs can be assigned to one heat-tracing circuit.
- Each NGC-40 control module (HTC, HTC3) and I/O module provides one programmable multi-purpose digital input for connection to external dry (voltage-free) contact or DC voltage.
- A dry contact relay per control module and a common alarm is available for alarm annunciation back to a Distributed Control System (DCS). Alternatively, the DigiTrace NGC-40 system can report alarm and monitoring data directly to the DCS via Modbus.
- Many heat-tracing related control algorithms available like ON/OFF, ambient sensing, PASC (Proportional Ambient Sensing Control) and proportional control (if used with solid state relays).
- The NGC-40 control modules operate independently from the user interface touch screen (TOUCH 1500) for increased system reliability. A failure of the TOUCH 1500 will not cause the heat-trace controllers to fail.
- DigiTrace NGC-40 is designed for easy installation and requires minimal wiring on site. All NGC-40 units are packaged in DIN rail mount housings, suitable for installation onto symmetric 35 mm DIN rails. Panel wiring is minimized by using internal network.
- Alarm Output: Each controller monitors and alarms on high or low temperature, load current and ground-fault alarm and trip points set at user defined levels. As required by the NEC and CEC, as an Equipment Protection Device, the controller switches all hot legs of a circuit for ground fault interruption.
- Power and current control on heat-tracing circuits to reduce inrush currents and unnecessary circuit breaker trips.
- Autocycling: The controller will momentarily energize the heat tracing at a user set interval and provide feedback if there are any problems with the heat trace.
- Circuit alarms will be generated as the fault occurs thereby reducing costs of preventative maintenance.
- The DigiTrace Supervisor (DTS) software package provides a remote, graphic interface for the DigiTrace NGC-40. The software allows the user to configure and monitor various NGC systems from a central location. DTS provides various levels of access for different user groups.

Benefits

- Individual circuit control by single circuit controllers provides highest reliability architecture for critical heat tracing circuits.
- Strategic location of DigiTrace Touch 1500 user interface linked to a group of heat-tracing panels leads to optimized maintenance activities.
- The touch screen interface (TOUCH 1500) provides local, easy, intuitive access to configuration, status, alarms and events of the heat-tracing system.
- Maximum flexibility in heat-tracing control design by using the innovative data sharing among the heat tracing circuits within a panel, as well as, the programmable digital inputs and alarm outputs of each control module.
- Modular System provides maximum flexibility to meet any need at an optimized cost. Individual control and standard communication wiring leads to flexible and optimized panel design to customer requirements.
- Choosing the right control algorithm leads to the most optimized heat-tracing solution by minimizing the energy consumption and installation cost.
- Permanent supervision of the integrity of the heat-tracing circuit and detailed problem reporting simplifies maintenance and increases personnel safety.
- Control on inrush currents leads to the reduction of panel power requirements and therefore significant savings on power distribution costs.
- Controls and monitors any type of heat-tracing cable.

- Central monitoring and configuration via DigiTrace Supervisor Software provides an audible alarm tone, the ability to acknowledge and clear alarms, and contains advanced features such as data logging, trending, implementing changes in batches, fault finding and other useful functions that help streamline operations and maintenance activities.

Single- and Dual-Point Control and Monitoring Systems

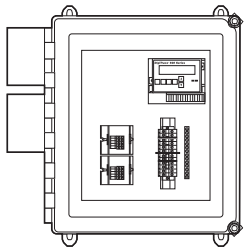

DigiTrace 920

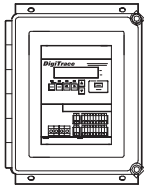

DigiTrace 910

DIGITRACE 910 AND 920 CONTROLLERS

The DigiTrace 910 single-point controller and the 920 dual-point controller sense pipe or tank temperatures to provide tight temperature control for process maintenance applications. They also feature continuous monitoring technology to detect heat-tracing faults, monitor heat-tracing current, and provide networking capabilities. The integral ground-fault protection eliminates the need to install ground-fault circuit breakers, which is especially useful when upgrading or retrofitting new heat-tracing circuits using existing circuit-breaker panels.

Select the DigiTrace 910 and 920 when designing single or dual heat-tracing circuits that require line sensing control and ground-fault protection. Both controllers are available as either single or double-pole units. The double-pole units switch both heat-tracing circuit power wires. Select the double-pole versions in phase-phase power situations such as 208 and 240 Vac.

The DigiTrace 910 and 920 are CSA certified (U.S. and Canada) for use in nonhazardous and Division 2 hazardous locations. The 920 is also approved by FM.

Reliable control

The units control heat-tracing circuits based on temperature measured by up to two RTD sensors. The heat-tracing circuit is switched by an internal 30 A solid-state relay using either on-off or proportional control. Other current ratings and devices are also available.

Complete monitoring

Monitoring functions ensure that the heat-traced process runs as designed by providing local and remote feedback on important heat-tracing parameters such as:

- Pipe temperature
- Heating cable system ground-fault level
- Heating cable current draw
- RTD sensor integrity
- Controller failure

When the heat-tracing circuit is interrupted, the DigiTrace 910 and 920 controllers detect and signal the fault condition and alert maintenance personnel, thus avoiding frozen pipes, process fluid degradation, and other costly problems.

Easy installation

The DigiTrace units are ready to install right out of the box, eliminating the need for custom panel design and field assembly. Wiring is as simple as connecting incoming and outgoing power wiring and an RTD. An alarm relay is provided for remote annunciation.

Simple operation

Both the 910 and 920 front panels have an LED display, status LEDs, dedicated function keys, and full-text descriptions that make the units easy to configure and operate. All settings are stored in nonvolatile memory in the event of power failure.

DigiTrace 910 and 920 units can be connected in a network to a central PC running DigiTrace Supervisor or plant DCS. All settings, operating parameters, and alarms may be accessed from a central location, reducing the need to dispatch maintenance personnel to field-mounted controllers.

Features

- Controls and monitors one or two heat-tracing circuits (up to 30 or 60 Amps).
- Senses pipe or ambient temperature with RTDs (see Table 11 DigiTrace RTD Selection Matrix).
- Operates on any voltage from 100 Vac to 277 Vac.
Note: Phase-phase systems may require double-pole versions.
- Replaces ground-fault circuit breakers with integral ground-fault protection.
- Provides alarms for low and high temperature, low and high current, low and high voltage, ground leakage, damaged RTD sensor, solid-state relay failure, micro-processor failure.
- Includes alarm relay contacts and network communication capability for remote annunciation and configuration.
- Operates reliably with industrial electronics enclosed in a rugged NEMA 4X FRP enclosure.
- Approved for use in nonhazardous and Division 2 hazardous locations.

Benefits

- Alerts maintenance personnel of a heat-tracing interruption and advises the exact nature of any problems as they occur.
- Realizes significant maintenance labor cost savings, since heat-tracing system inspections are easier.
- Easy to program, operate, and interpret normal alarm conditions.

Saves time and money

- System includes ground-fault interruption to fulfill the requirements of national electrical codes.
- Lowest installed cost in the market for comparable technological features.
- Single-unit simplicity of the DigiTrace 910 and 920 makes installation easy.
- Eliminates the need to purchase additional handheld programming devices or thermostats.

Expands to meet your needs

- DigiTrace 910 and 920 units can be networked to a central PC running DigiTrace Supervisor to provide a complete overview of the heating system, and additional units can be added as needed.
- Easy-to-use DigiTrace Supervisor software provides complete setup and monitoring from a single location.

THERMOSTATS

Ambient-Sensing Thermostats

These thermostats are used to control heating cable circuits in freeze protection applications. When the outdoor temperature drops below the set point, the thermostat switches on. Control multiple circuits by connecting the thermostat to the coil of a contactor.

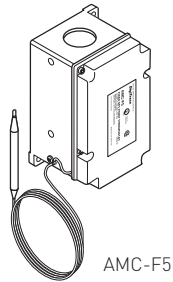

AMC-F5

AMC-F5

This thermostat has a fixed set point of 40°F (5°C) and is used for freeze protection applications. The SPST switch, rated 480 Vac, 22 A, is enclosed in a plastic NEMA 4X enclosure. The tin-plated copper sensor assembly is 30 inches long. The unit is UL Listed and CSA certified for use in nonhazardous locations. Select this low-cost thermostat for areas not subject to mechanical abuse.

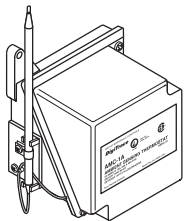

AMC-1A

AMC-1A

This thermostat has an adjustable set point between 15°F and 140°F (-9°C and 60°C) and is used for freeze protection applications. The NEMA 4X enclosure is coated cast aluminum with stainless steel hardware. The switch is rated 480 Vac, 22 A. The stainless steel sensor assembly is permanently mounted to the enclosure. The unit is UL Listed and CSA certified for use in nonhazardous locations. Select this thermostat where set-point adjustment or mechanical ruggedness is important.

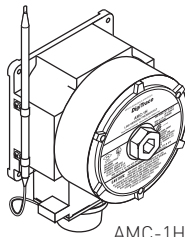

AMC-1H

AMC-1H

This is the hazardous location-approved version of the AMC-1A. It includes a NEMA 4, 7, 9 coated cast-aluminum enclosure and is approved by FM, UL Listed, and CSA certified for use in Division 1 and 2 hazardous locations. Select this thermostat when the control unit must be located in a hazardous location.

Line-Sensing Thermostats

These thermostats are used to control heating cable circuits used in freeze protection and process-temperature maintenance applications. All can be used to switch a heat-tracing circuit directly or switch the coil of a contactor. Those with adjustable set points can be used instead to indicate low- or high-temperature alarm conditions.

JBS-100-ECP-A and JBS-100-ECW-A

The JBS-100-ECP-A and JBS-100-ECW-A are electronic temperature controllers that provide accurate control of a heating circuit using a RTD sensor. The JBS-100-ECP-A is pipe mounted and serves as a power connection kit for Raychem self-regulating, power-limiting and Pyrotenax mineral insulated heating cables. The JBS-100-ECW-A is wall mounted and may be used with all types of heating cables. The JBS-100-ECW-A can only be used as a power connection with Pyrotenax mineral insulated cables. Combining the power connection and controller into one single unit will significantly reduce installation cost. Both the JBS-100-ECP-A and JBS-100-ECW-A have adjustable set points between 32°F to 425°F (0°C to 218°C), power input of 120 Vac to 277 Vac, and switches current up to 30 A. A local display allows for monitoring of set point, actual temperature, and also indicates alarm conditions (high/low temperature and sensor failure). A form C contact allows for remote annunciation of alarms. These units are c-CSA-us (certified to U.S. and Canadian Standards) for use in nonhazardous locations.

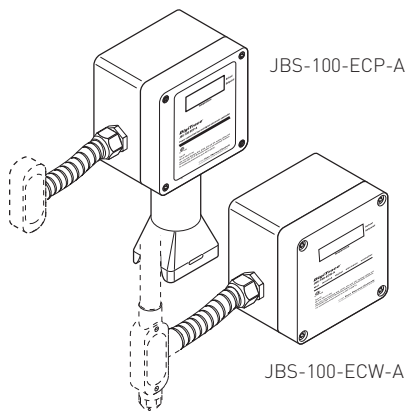

JBS-100-ECP-A

JBS-100-ECW-A

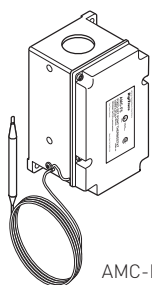

AMC-F5

AMC-F5

This low-cost thermostat has a fixed set point of 40°F (5°C) and is used for freeze protection. The SPST switch, rated 480 Vac, 22 A, is enclosed in a plastic NEMA 4X enclosure. The tin-plated copper sensor assembly is 30 inches long. The unit is UL Listed and CSA certified for use in nonhazardous locations. Select this low-cost thermostat when using line sensing control for freeze protection in areas not subject to mechanical abuse.

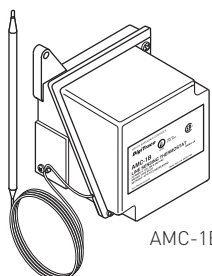

AMC-1B

AMC-1B

This thermostat has an adjustable set point between 25°F and 325°F (-4°C and 163°C). The NEMA 4X enclosure is coated cast aluminum with stainless steel hardware. The SPDT switch is rated 480 Vac, 22 A. The stainless steel sensor assembly is 9 ft (3 m) in length. The unit is UL Listed and CSA certified for use in nonhazardous locations. Select this thermostat where set point adjustment or mechanical ruggedness is important.

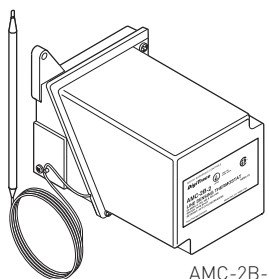

AMC-2B-2

AMC-2B-2

This is the two-pole version of the AMC-1B. It has an adjustable setpoint between 25°F and 325°F (-4°C and 163°C). The control switch in this thermostat opens both heat-tracing circuit power wires. Select this thermostat when local safety standards require that both phases be switched in phase-to-phase supplies such as 208 and 240 Vac. The unit is UL Listed and CSA certified for use in nonhazardous locations. Select this thermostat where set point adjustment or mechanical ruggedness is important.

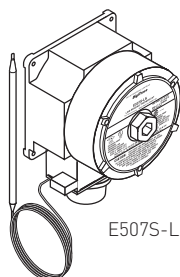

E507S-LS

E507S-LS

This is the hazardous location-approved version of the AMC-1B. It has an adjustable setpoint between 25°F and 325°F (-4°C and 163°C). It includes a NEMA 4, 7, 9 coated cast-aluminum enclosure and is approved by FM, UL Listed, and CSA certified for use in Division 1 and 2 hazardous locations. Select this thermostat when the control unit must be located in a hazardous location.

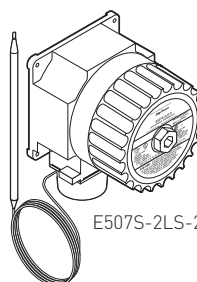

E507S-2LS-2

E507S-2LS-2

This is the two-pole version of the E507S-LS. It has an adjustable setpoint between 25°F and 325°F (-4°C and 163°C). The control switch in this thermostat opens both heat-tracing circuit power wires. Select this thermostat when local safety standards require that both phases be switched in phase-to-phase supplies such as 208 and 240 Vac. It includes a NEMA 4, 7, 9 coated cast-aluminum enclosure and is approved by FM, UL Listed, and CSA certified for use in Division 1 and 2 hazardous locations. Select this thermostat when the control unit must be located in a hazardous location.

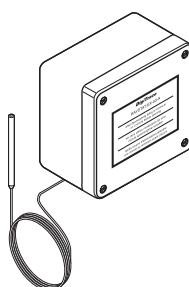

RAYSTAT-EX-03-A

RAYSTAT-EX-03-A

This is an electronic line sensing thermostat particularly suited for high-temperature applications, with an adjustable set point to 930°F (499°C). The unit has a DPDT switch rated 277 Vac, 16 A, inside a NEMA 4X polymeric enclosure. The preinstalled stainless steel RTD sensor assembly is 6 ft (2 m) long. The unit is c-FM-us (approved for US and Canadian standards) for use in Zone 1 or Division 2 hazardous locations. Select this thermostat for high-temperature applications or for precise temperature control.

TEMPERATURE SENSORS

Pentair Thermal Management provides a variety of temperature sensing solutions. From RTDs to temperature aggregation and communications, DigiTrace products meet every application need and help reduce installation costs.

DigiTrace RMM2 (Remote Monitoring Module)

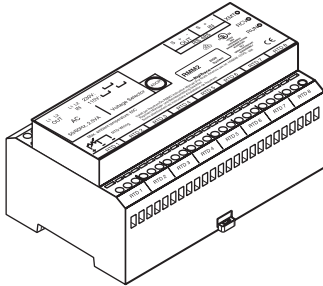

The DigiTrace remote monitoring module (RMM2) provides temperature monitoring capability for the NGC-30 and NGC-40 heat-tracing control and monitoring systems. The RMM2 accepts up to eight RTDs that measure pipe, vessel, or ambient temperatures in a heat-tracing system. The RMM2 modules are used to aggregate RTD wires in one remote location and send the information back to the control system through a single twisted pair cable. This helps reduce installation costs since only one conduit run returns to the controller, rather than eight. Multiple RMM2s communicate with a single NGC-30 or NGC-40 to provide centralized monitoring of temperatures. A single, twisted pair RS-485 cable connects up to 16 RMM2s for a total monitoring capacity of 128 temperatures.

Each temperature sensor connected to a RMM2 may have individual low- and high-temperature alarms. Alarm limits are set and alarm conditions are reported at the NGC-30 control panel. Additional alarms are triggered for failed temperature sensors and communication errors. Alarms may be reported remotely through an alarm relay in the control system or through an RS-485 connection to a host computer supporting the Modbus protocol.

The RMM2 clips to a DIN 35 rail and can be mounted in a choice of enclosures, as required for the area classification and environment. For aggressive environments and Division 2 hazardous locations, Pentair Thermal Management offers a glass-reinforced polyester NEMA 4X enclosure.

DigiTrace PLI (Power-Line Carrier Interface)

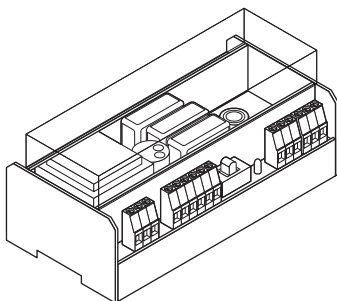

DigiTrace power-line carrier interfaces (PLI) modules provide temperature-monitoring capability for the DigiTrace NGC-30 heat-tracing control and monitoring unit. The PLI receives input from the power wires for the heat-tracing circuits, which carry the signals from special transmitters. The transmitters provide pipe temperatures from RTDs and continuity confirmation; they are typically located at the unpowered end of the heat-tracing line.

A single twisted-pair RS-485 cable connects up to four PLI modules to a DigiTrace NGC-30.

The DigiTrace PLI system uses frequency-shift keying to encode digital data on the power-line network. Digital ones and zeros are transmitted by coupling high-frequency signals onto the heat-tracing bus wires and the AC power line. The digital data are transmitted in packets that contain error-checking fields to validate the correctness of the data. Since no additional wiring is required to bring temperature and continuity data back to a central location, installation and maintenance costs are significantly reduced.

The DigiTrace PLI modules are designed to be local to the distribution transformer that supplies power to the heat-tracing circuits. Only one PLI module may be used on the secondary side of each heat-tracing transformer. A filter (MoniTrace 700-FEF) is required on the primary side of each transformer to provide electrical noise isolation between the plant environment and the heat-tracing power-line network environment. This ensures that transmissions between the PLI module and the transmitters, SES (Smart End Seal) or SPC (Smart Power Connection), are reliable and error-free.

The DigiTrace PLI module is an electronic device mounted in an enclosure that is to be clipped to a DIN 35-mm rail in a nonhazardous, indoor location only.

DigiTrace SES Transmitter (Smart End Seal)

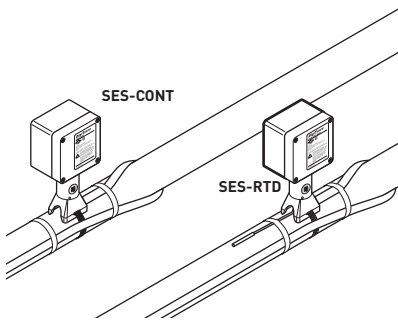

The SES series of transmitters is used in conjunction with the DigiTrace PLI and comes in two types: temperature/continuity transmitter (SES-RTD) and continuity transmitter (SES-CONT). These transmitters are used in freeze protection and process temperature maintenance applications. The system is unique in that the heating cable bus wires and power cables carry the monitoring signals. No additional field wire is necessary.

The SES-RTD transmitter (typically placed at the end of a heater circuit) replaces conventional RTD sensing elements and associated wiring, sending temperature and continuity information to the central microprocessor-based controller. The SES-CONT provides heater continuity only. The SES is designed for use only with Raychem brand BTV, QTVR, XTV, and VPL parallel heating cables.

The SES transmitter requires a programmable controller (NGC-30), a power line carrier interface (PLI) module, and power-switching contactor panel. Up to 127 strategically placed SES transmitters communicate with one PLI (one PLI per heat-tracing transformer). A total of four PLIs can be connected to each NGC-30 panel.

The SES system requires a dedicated heat-tracing transformer (only the heat-tracing can be connected to the transformer) and MoniTrace 700-FEF front end filter to provide electrical noise isolation between the plant environment and the heat-tracing power in network environment. This ensures that transmission between the PLI module and the SES transmitters is reliable and error-free.

DigiTrace RTDs

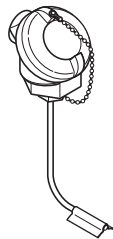

DigiTrace RTDs (Resistive Temperature Detectors) are used to sense ambient or line temperatures and provide feedback to control device. A variety of materials and construction techniques provide solutions for all temperature-sensing requirements. Refer to the table below for product selection.

TABLE 11 DIGITRACE RTD SELECTION MATRIX

Catalog number	Maximum exposure	Approvals	Application
RTD-200	200°F (93°C)	Approval associated with control device. Not to be used in Division 1 hazardous locations.	Use when ambient RTD sensor is required.
RTD3CS	400°F (204°C)	Approval associated with control device. Not to be used in Division 1 hazardous locations	Used for pipes or tanks when controller is 3 feet or less from bulb placement. Use RTD extension wire/conduit (terminated in the appropriate enclosure for the area classification) to extend the lead wire to the required length. Not to be used for underground applications.
RTD10CS	400°F (204°C)	Approval associated with control device. Not to be used in Division 1 hazardous locations	Used for pipes or tanks when controller is 10 feet or less from bulb placement. Use RTD extension wire/conduit (terminated in the appropriate enclosure for the area classification) to extend the lead wire to the required length. Not to be used for underground applications.
RTD4AL	900°F (482°C)	<ul style="list-style-type: none"> • CSA (U.S. & Canada) • Class I, Div. 2, Groups A, B, C, D • Class II, Div. 2, Groups F, G 	Used for pipes and includes junction box to extend the lead wire to the required length using RTD extension wire/conduit.
RTD7AL	900°F (482°C)	<ul style="list-style-type: none"> • CSA (U.S. & Canada) • Class I, Div. 1, Groups C, D • Class II, Div. 1, Groups E, F, G 	Used for pipes and includes junction box to extend the lead wire to the required length using RTD extension wire/conduit.
RTD10	1100°F (593°C)	<ul style="list-style-type: none"> • CSA (U.S. & Canada) • Class I, Div. 1 & 2, Groups A, B, C, D • Class II, Div. 1 & 2, Groups E, F, G • Class III 	Used for pipes or tanks when controller is 10 feet or less from bulb placement. Use RTD extension wire/conduit (terminated in the appropriate enclosure for the area classification) to extend the lead wire to the required length. Additional lengths are available; contact Pentair Thermal Management for additional information.
RTD20	1100°F (593°C)	<ul style="list-style-type: none"> • CSA (U.S. & Canada) • Class I, Div. 1 & 2, Groups A, B, C, D • Class II, Div. 1 & 2, Groups E, F, G • Class III 	Used for pipes or tanks when controller is 20 feet or less from bulb placement. Use RTD extension wire/conduit (terminated in the appropriate enclosure for the area classification) to extend the lead wire to the required length. Additional lengths are available; contact Pentair Thermal Management for additional information.



WWW.PENTAIRTHERMAL.COM

NORTH AMERICA

Tel: +1.800.545.6258
Fax: +1.800.527.5703
Tel: +1.650.216.1526
Fax: +1.650.474.7711
thermal.info@pentair.com

EUROPE, MIDDLE EAST, AFRICA

Tel: +32.16.213.511
Fax: +32.16.213.603
thermal.info@pentair.com

ASIA PACIFIC

Tel: +86.21.2412.1688
Fax: +86.21.5426.2917
cn.thermal.info@pentair.com

LATIN AMERICA

Tel: +1.713.868.4800
Fax: +1.713.868.2333
thermal.info@pentair.com

All Pentair trademarks and logos are owned by Pentair or its global affiliates. Pentair reserves the right to change specifications without prior notice.

© 2001-2013 Pentair.