

Headquarters:
Wieland Electric GmbH
Brennerstraße 10 – 14
D-96052 Bamberg

Sales and Marketing Center:
Wieland Electric GmbH
Benzstraße 9
D-96052 Bamberg

Phone +49 (951) 9324-0
Fax +49 (951) 9324-198
www.wieland-electric.com
www.gesis.com
info@wieland-electric.com

AT Wieland

Components and system components
for the control cabinet

- DIN rail terminal blocks
 - with screw connection
 - with spring clamp connection
 - with IDC connection
- Safety
 - Safety relays
 - Modular safety systems
- Fieldbus components
- Interface
 - Power supplies
 - Overvoltage protection
 - Measuring and monitoring relays
 - Time and switching relays
 - Coupling relays/solid state relays
 - Analog modules
 - Passive interfaces

Components and system components
for field applications

- Remote automation
 - Remote power distribution
 - Remote fieldbus interface
- Industrial multipole connectors
 - Modular multipole connectors
 - High-density multipole connectors
 - High-current multipole connectors
 - Multipole connectors for hazardous areas
 - Bushings for control cabinets
 - D-Sub connectors
- Round connectors

Empty housings and appliance
connectors/terminal strips

AT Schleicher

PLC systems and CNC based control systems

- Operator panels
- Application engineering & system solutions
- Customized products

BIT Wieland

- Building installation systems
 - Mains connectors IP20/IP65...IP68
 - Bus connectors
 - Combined connectors
 - Low-voltage connectors
 - Flexible flat cable systems
 - Distribution systems
 - Switching devices for EIB/KNX, LON, Ethernet, radio control
 - DIN rail terminal blocks for electrical installations
 - Overvoltage protection

PCB connectors Wieland

- PC board connectors
- PC board connectors
 - with screw connection
 - with spring clamp connection
 - with TOP connection

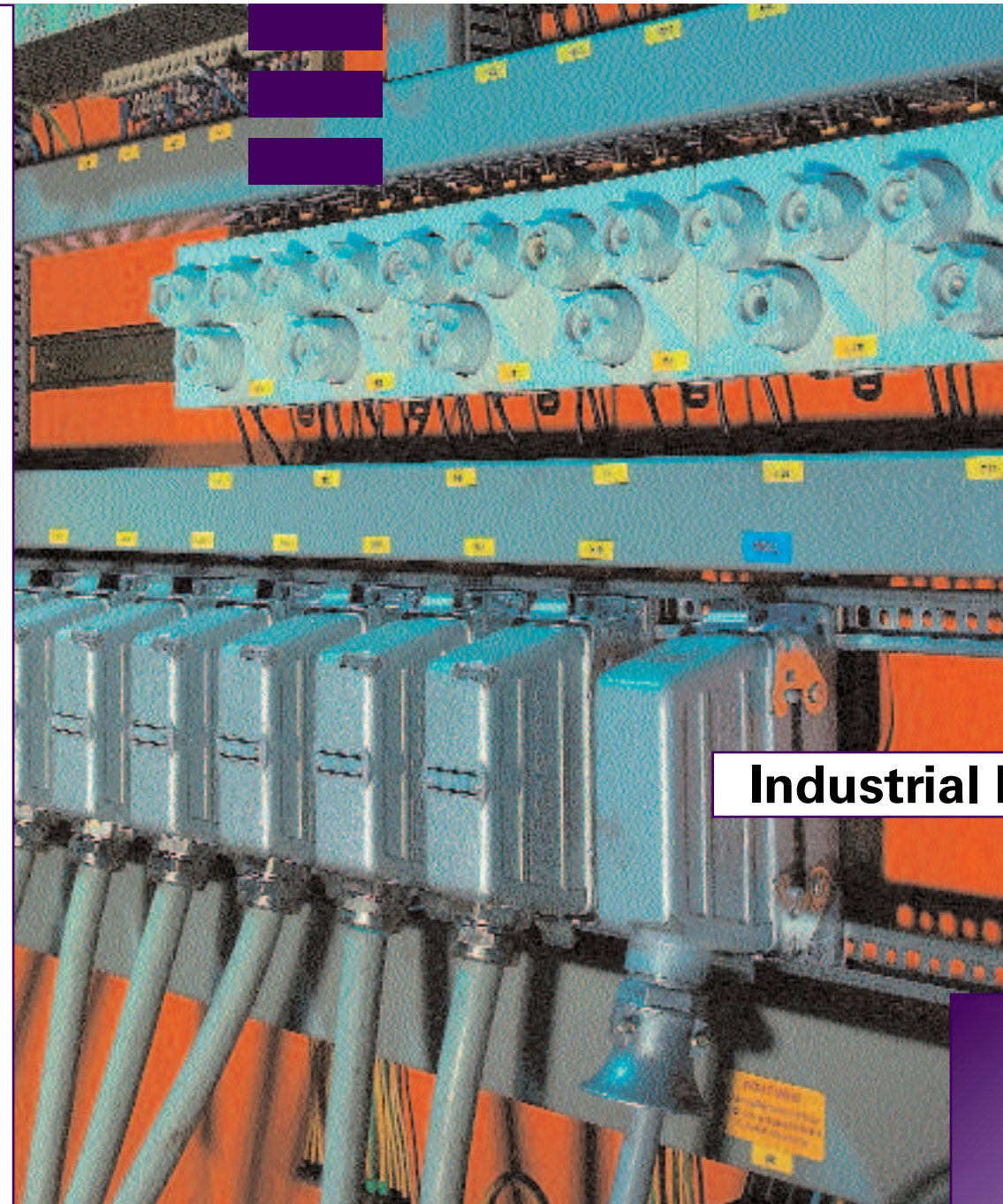

revos

Industrial Multipole Connectors

3-/ 48 pole
connectors in
metal housing

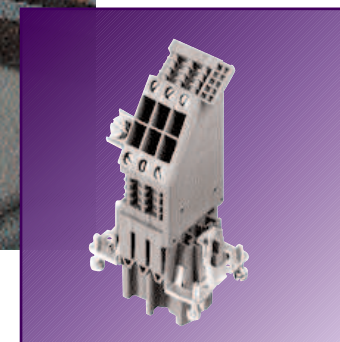

P r o d u c t R a n g e

















0078.6 MC 06/05

Industrial multipole connectors 3, 4, 7 pole + ground / 8 pole

revos MINI



Degree of protection IP 54
Degree of protection IP 65 with the appropriate cable glands

	Cross section	Approvals	Wire strip length	Material	Std. pack	
 Screw connection	Female insert 0.5 – 2.5 mm ² 3 pole 18 – 16 AWG UL 4 pole 22 – 12 AWG UL 3, 4 pole 22 – 12 AWG CSA	  for 3 pole	4 mm	tin-plated (3 pole) silver-plated (4 pole)	10	
	Male insert 0.5 – 2.5 mm ² 3 pole 18 – 16 AWG UL 4 pole 22 – 12 AWG UL 3-/4 pole 22 – 12 AWG CSA	  for 3 pole	4 mm	in-plated (3 pole) silver-plated (4 pole)	10	
 Crimp connection	Female insert without crimp contacts 0.2 – 1.5 mm ² 18 – 16 AWG UL 24 – 16 AWG CSA	  for 3 pole	4 mm		10	
	Male insert without crimp contacts 0.2 – 1.5 mm ² 18 – 16 AWG UL 24 – 16 AWG CSA	  for 3 pole	4 mm		10	
Thread size	Cable gland type	Material	Stand. pack			
 M 20	Hood, angled	0 with cable gland 1 with thread 1 with thread	Metal Metal Plastic	10 10 10		
	 M 20	Hood, straight	0 with cable gland 1 with thread 1 with thread	Metal Metal Plastic	10 10 10	
		 M 20	Hood, with locking lever for cable to cable couplings	0 with cable gland 1 with thread 1 with thread	Metal Metal Plastic	10 10 10
			Open-bottom housing		Metal Plastic	10 10
			Open-bottom housing, angled		Metal Plastic	10 10
 M 20		Closed-bottom housings	0 with cable gland	Metal	10	
	1 with thread		Metal	10		
	with IP 68 gland		Plastic	10		

revos

Contacts for crimp version

Female contacts



Male contacts



Ø mm ²	AWG	Part no.	Stand. pack	Ø mm ²	AWG	Part no.	Stand. pack
0.2 – 0.56 mm ²	24 – 20	tin-plated		0.5 – 1.50 mm ²	24 – 20	gold-plated	
Reel contacts		02.124.0900.0	5000	Reel contacts		02.124.1400.0	5000
Single contacts		02.124.0929.0	200	Single contacts		02.124.1429.0	200
0.75 – 1.50 mm ²	18 – 16						
Reel contacts		02.124.1000.0	5000				
Single contacts		02.124.1029.0	200				
0.2 – 0.56 mm ²	24 – 20			0.5 – 1.50 mm ²	20 – 16		
Reel contacts		05.544.0900.0	5000	Reel contacts		05.544.1400.0	5000
Single contacts		05.544.0929.0	200	Single contacts		05.544.1429.0	200
0.75 – 1.50 mm ²	18 – 16						
Reel contacts		05.544.1000.0	5000				
Single contacts		05.544.1029.0	200				
				Crimping tool		95.101.0800.0	1
				Crimping die "E"		05.502.2400.0	1
				Contact positioner "2"		05.502.3200.0	1
				Extraction tool		05.502.0000.0	1

3 pole + ground

Plastic housing UL/CSA
400 V/4 kV, 10 A 600 V
Metal housing
250 V/400 V/4 kV, 10 A 600 V

Part no.
73.300.0353.0
73.310.0353.0

4 pole + ground

Plastic housing UL/CSA
400 V/6 kV, 10 A 600 V
Metal housing
400 V/6 kV, 10 A 600 V

Part no.
73.300.0453.0
73.310.0453.0

7 pole + ground

Plastic housing UL/CSA
250 V/4 kV, 10 A 600 V
Metal housing
50 V/0.8 kV, 10 A 42 V

Part no.
73.700.0753.0
73.710.0753.0

8 pole

Plastic housing UL/CSA
50 V/0.8 kV, 10 A 42 V
Metal housing
50 V/0.8 kV, 10 A 42 V

Part no.
73.700.0853.0
73.710.0853.0

Accessories

Part no.	Part no.
	
Cover with locking bolts for housing and hood with locking levers	Cover with locking bolts for housing and hood with locking levers
without gasket for male insert	with gasket for female insert
Plastic 07.417.6753.0 Metal 07.417.6729.0	Plastic 07.417.6853.0 Metal 07.417.6829.0

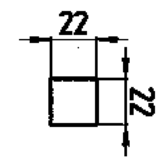

Mounting dimensions and cut-outs for open-bottom housings

Crimp contacts revos BASIC

Female contacts



Male contacts



Crimping tool
Crimping die "B"
Contact positioner "3"
Extraction tool

Ø mm ²	AWG	Part no.	Std. pack	Ø mm ²	AWG	Part no.	Std. pack
tin-plated				gold-plated			
0.5	20 AWG	02.123.7021.0	200	0.5	20 AWG	02.123.7001.0	200
0.75 - 1	18 AWG	02.123.7121.0	200	0.75 - 1	18 AWG	02.123.7101.0	200
1.5	16 AWG	02.123.7221.0	200	1.5	16 AWG	02.123.7201.0	200
2.5	14 AWG	02.123.7321.0	200	2.5	14 AWG	02.123.7301.0	200
4	12 AWG	02.123.7421.0	200	4	12 AWG	02.123.7401.0	200
silver-plated on request							
		95.101.0800.0	1				
		05.502.2100.0	1				
		05.502.3300.0	1				
		05.502.3500.0	1				

Glands



Cable gland from nickel-plated brass, with internal strain relief and gasket on the connection thread, for IP 68 degree of protection

Metric thread	>ØK in mm	Ø mm	Thread length in mm	Part no.	Std. pack
M 20 x 1.5	8.0 - 13.0	22	6	Z5.507.1321.0	10
M 25 x 1.5	11.0 - 18.0	27	7	Z5.507.1521.0	10
M 32 x 1.5	15.0 - 21.0	34	8	Z5.507.1721.0	10
M 40 x 1.5	19.0 - 27.0	44	8	Z5.507.1921.0	10

Hoods and housings with a brass cable gland and IP 68 degree of protection can be preassembled on request for minimum order quantities of 50 pieces.



Plastic cable gland made of Polyamide, gray (RAL 7035), with strain relief IP 68 degree of protection

Metric thread	>ØK in mm	Ø mm	Thread length in mm	Part no.	Std. pack
M 20 x 1.5	6.0 - 12.0	24	9	Z5.507.1353.0	10
M 25 x 1.5	7.0 - 16.0	28	11	Z5.507.1553.0	10
M 32 x 1.5	10.0 - 21.0	36	11	Z5.507.1753.0	10
M 40 x 1.5	16.0 - 28.0	46	11	Z5.507.1953.0	10

For the use of plastic glands, the size 6 housings must have an intermediate support.

1) Six coding options with coding pins

Coding pin

Part no. for version A: 05.592.0621.0 100

The use of coding pins enables six combinations for 3 pole, 6 pole, 10 pole, 16 pole and 24 pole multipole connectors.

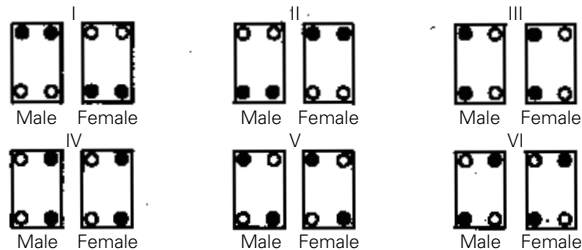

2) 72 coding options with coding pin, female coding piece and coding bolt

The use of coding pins and female coding pieces enables 16 different codings. With an additional coding pin, up to 72 coding options are possible.

All fastening screws must be replaced by the coding components.

- Coding bolts 05.576.6912.0
- Coding pin 05.576.6612.0
- Female coding piece 05.576.6712.0

Technical data

Hoods

Size	L in mm	B in mm	H in mm
6 pole	60	43	47.5
10 pole	73	43	53
10 pole high design	73	43	70
16 pole	93.5	43	60
16 pole high design	93.5	43	76
24 pole	120	43	70
24 pole high design	120	43	76
32 pole	93.5	82.5	94
48 pole	132	90	107

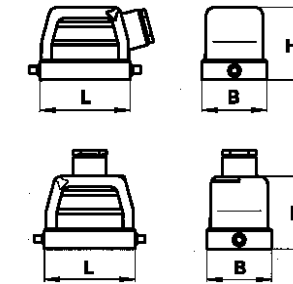

Housings

Size	Open-bottom housings			Closed-bottom housings		
	L in mm	B in mm	H in mm	L1 in mm	B1 in mm	H1 in mm
6 pole	80	43	28	84	52	54.5
10 pole	93	43	28	94	52	54.5
16 pole	113	43	28	117	52	56.5
16 pole high design				117	52	76.5
24 pole	140	43	28	144	52	56.5
24 pole high design				144	52	76.5
32 pole	124	84	35			
48 pole	165	90	44	146	120	99

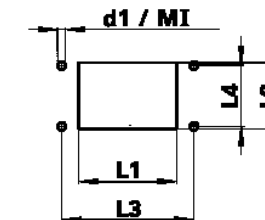
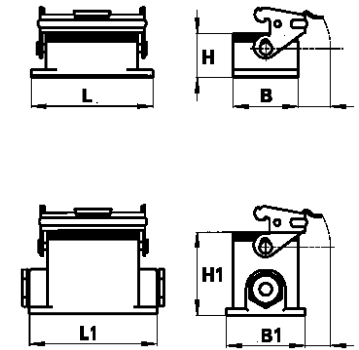

Mounting dimensions and cut-outs for open-bottom housings

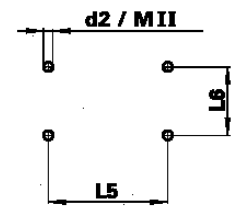

Mounting dimensions for closed-bottom housings

Single locking lever

Size	Cut-out		Mounting holes		d1	MI
	L1	L2	L3	L4		
6	52	35	70	32	4.3	M 4
10	65	35	83	32	4.3	M 4
16	85.5	35	103	32	4.3	M 4
24	112	35	130	32	4.3	M 4
48	117	81	148	70	6.4	M 6

Size	L5	L6	d2	MII
6	70	40	5.5	M 5
10	82	40	5.5	M 5
16	105	45	5.5	M 5
24	132	45	5.5	M 5
48	111	106	6.5	M 6

Double locking lever

Size	Cut-out		Mounting holes		d1	MI
	L1	L2	L3	L4		
10	65	35	83	32	4.3	M 4
16	85.5	35	103	32	4.3	M 4
24	112	35	130	32	4.3	M 4
32	86	71	110	64	5.5	M 5

Size	L5	L6	d2	MII
10	82	40	5.5	M 5
16	105	45	5.5	M 5
24	132	45	5.5	M 5