

VuLife®

4" TC LOW VOLTAGE NEW CONSTRUCTION HOUSING

LOW VOLTAGE LAMPS
V4TCLVW

Project: _____
 Fixture Type: _____
 Location: _____
 Contact/Phone: _____

PRODUCT DESCRIPTION

TC Housing designed for use in non-insulated areas • If installed where insulation is present, the insulation must be pulled back 3" from all sides of the TC housing • In Canada, when insulation is present, type IC fixture must be used.

PRODUCT SPECIFICATIONS

Lamp One 12V, 50W MR16 lamp.

Socket Ceramic bi-pin socket with aluminum heat shield.

Trims Trim selection shown on reverse.

Transformer 120V to 12V 50VA thermally protected magnetic transformer mounted to junction box.

Dimming May be dimmed using dimmers specifically designed for low voltage magnetic transformers; consult factory or dimmer manufacturer for additional information.

Labels UL/cUL listed for through-branch wiring, damp locations and IP • Product thermally protected against improper use of lamps or insulation • UL/cUL Listed • Trim V4041 is wet location approved for covered ceiling applications.

Testing All reports are based on published industry procedures; field performance may differ from laboratory performance.

Product specifications subject to change without notice.

INSTALLATION

Bar Hangers Telescoping bar hangers with captive nail allow for quick placement of housing anywhere within 24" O.C. joists • Can be installed in suspended ceiling grid using T-bar clip accessory • Bars scored in two locations for fast, clean breaking, allowing housing installation in tight applications • Edge-mounted for extra strength and captive to mounting frame • May be installed either perpendicular or parallel to junction box • Locking set screw locks fixture in position • Alternate mounting holes included.

Junction Box Pre-wired junction box provided with (5) 1/2" and (1) 3/4" knockout, (4) Non-metallic sheathed cable connectors and ground wire, UL/cUL listed for through-branch wiring, maximum 8 No. 12 AWG 90° C branch circuit conductors (4 in, 4 out)
 • Junction box provided with removable access plates
 • Knockouts equipped with pryout slots.

Mounting Frame 22-gauge die-formed galvanized steel mounting frame • Rough-in section (junction box, mounting frame, housing and bar hangers) fully assembled for ease of installation.

Housing TC housing, 22-gauge aluminum • Housing is vertically adjustable to accommodate up to a 1" ceiling thickness.

DIMENSIONS

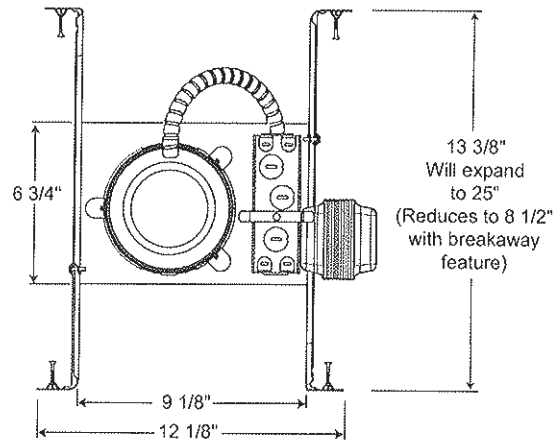
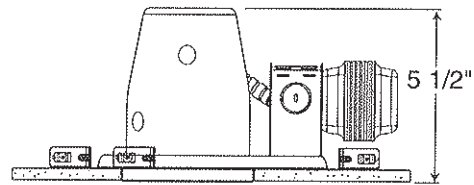

4 1/2" CEILING CUTOUT

PRODUCT CODES

Catalog Number	Input Voltage	Lamp Rating (max.)
V4TCLVW	120V	12V 50W MR16

ACCESSORIES

Catalog No.	Description
G2405	T-Bar Clips (Set of 4)





To order, specify catalog number.

4" TC LOW VOLTAGE NEW CONSTRUCTION HOUSING

LOW VOLTAGE LAMPS

V4TCLVW

TRIMS/LAMPS

	Cat. No.	Description	Max. Lamp Rating
	V4044W-WH V4044B-WH	White Baffle with Regressed Gimbal Ring Black Baffle with Regressed Gimbal Ring	50W MR 16
	V4047C-WH	Clear Cone with Regressed Gimbal Ring	50W MR 16
	V4040-WH	White Gimbal Ring	50W MR 16
	V4048-WH	White Eyeball with Baffle	50W MR 16
	V4041-WH ◆	Stippled Opal Lens Shower	50W MR 16

Note: Lamps may be dimmed. Use dimmers specifically designed for low voltage magnetic transformers; consult factory or dimmer manufacturer for additional information.

Trim Size: 5" O.D.

Trim Finish: WH - White.

Note: In Canada when insulation is present, Type IC fixtures must be used.

◆ UL/cUL listed for use in wet location.



1300 S. Wolf Road • Des Plaines, IL 60018 • Phone (847) 827-9880 • Fax (847) 827-2925
 220 Chrysler Drive • Brompton, Ontario • Canada L6S 6B6 • Phone (905) 792-7335 • Fax (905) 792-0064
 Visit us at www.junolightinggroup.com

Printed in U.S.A. ©2011 Juno Lighting, LLC.