

VuLite®

5" IC NEW CONSTRUCTION HOUSING

INCANDESCENT LAMPS

V5ICW

Project: _____

Fixture Type: _____

Location: _____

Contact/Phone: _____

PRODUCT DESCRIPTION

IC Air-Loc® Housing • Energy efficient, sealed housing • Can be completely covered with insulation • When used with Air-Loc Gasket (see accessories), stops infiltration and exfiltration of air, reducing heating and cooling costs • Trims shown with Air-Loc symbol  do not require a gasket.

PRODUCT SPECIFICATIONS

Lamp Lamp ratings based on trim selected—see reverse.

Socket Medium base porcelain with nickel-plated copper screw shell • Floating socket with spring attaches to trim for installation • Shipped with socket cap to protect against paint overspray.

Trims Trim selection shown on reverse.

Labels UL/cUL listed for through-branch wiring, damp locations and IP • Product thermally protected against improper use of lamps • UL/cUL Listed • Trim V2010 is wet location approved for covered ceiling applications • Trims V2015 and V2016 are wet location approved for covered ceiling applications, **when used with outdoor rated PAR lamps.**

Testing All reports are based on published industry procedures; field performance may differ from laboratory performance.

Product specifications subject to change without notice.

INSTALLATION

Bar Hangers Telescoping bar hangers with captive nail allow for quick placement of housing anywhere within 24" O.C. joists • Can be installed in suspended ceiling grid using T-bar clip accessory • Bars scored in two locations for fast, clean breaking, allowing housing installation in tight applications • Edge-mounted for extra strength and captive mounting frame • May be installed either perpendicular or parallel to junction box • Locking set screw locks fixture in position • Alternate mounting holes included.

Junction Box Pre-wired junction box provided with (5) 1/2" and (1) 3/4" knockouts, (4) Non-metallic sheathed cable connectors and ground wire, UL/cUL listed for through-branch wiring, maximum 8 No. 12 AWG 90° C branch circuit conductors (4 in, 4 out) • Junction box provided with removable access plates • Knockouts equipped with pryout slots • Push-in electrical connectors included.

Mounting Frame 22-gauge die-formed galvanized steel mounting frame • Rough-in section (junction box, mounting frame, housing and bar hangers) fully assembled for ease of installation.

Housing IC housing, .032" aluminum sealed for Air-Loc Compliance • Housing is vertically adjustable to accommodate up to a 1" ceiling thickness.

DIMENSIONS

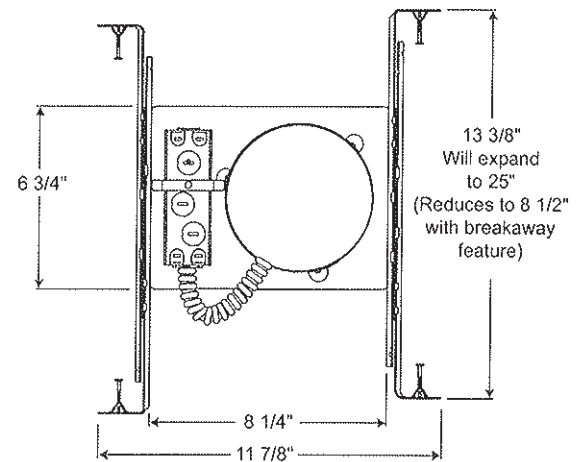
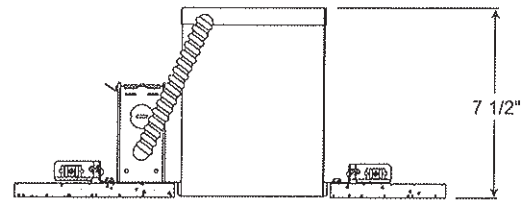

5 5/8" CEILING CUTOUT

ACCESSORIES

Catalog No.	Description
ALG5	Air-Loc Gasket Kit
G2405	T-Bar Clips (Set of 4)

To order, specify catalog number.

PRODUCT CODES

Catalog Number	Input Voltage	Lamp Rating (max.)
V5ICW	120V	PAR30/PAR30L/BR30/R20/PAR20 (See reverse for max. trim rating)











5" IC NEW CONSTRUCTION HOUSING

INCANDESCENT LAMPS

V5ICW

TRIMS/LAMPS

	Cat. No.	Description	Max. Lamp Rating
	 V2015W-WH ◆◆ V2015B-WH ◆◆	White Baffle Black Baffle	75W PAR30 (with socket extender), 75W PAR30L, 65W BR30, 50W PAR30 (black only)
	 V2016W-WH ◆◆ V2016C-WH ◆◆	White Cone Clear Cone	75W PAR30 (with socket extender), 75W PAR30L, 65W BR30
	 V2010-WH ◆	Stippled Opal Lens Shower with Reflector	35W PAR30L
	 V2029-WH	R/PAR20 Eyeball - White	50W R20, 50W PAR20
	 V2030-WH	PAR30 Eyeball - White	75W PAR30

Trim Size: V2015, V2016 and V2029 - 6¼" O.D. V2010 and V2030 - 6½" O.D.

Trim Finish: WH - White.

Note: In Canada when insulation is present, Type IC fixtures must be used.

◆ UL/cUL Listed for use in wet location.

◆◆ UL/cUL Listed for use in wet location with outdoor rated PAR lamp.

 Vulite IC housings meet IECC Energy Code requirements per ASTM E283.
Air-Loc® rated trims are pre-gasketed for minimum air leakage with IC housings.



1300 S. Wolf Road • Des Plaines, IL 60018 • Phone (847) 827-9880 • Fax (847) 827-2925
220 Chrysler Drive • Brampton, Ontario • Canada L6S 6B6 • Phone (905) 792-7335 • Fax (905) 792-0064
Visit us at www.junolightinggroup.com

Printed in U.S.A. ©2011 Juno Lighting, LLC.