

FEATURES & SPECIFICATIONS

INTENDED USE — Recessed housing rated IC for new construction only.

Approved for all ceiling and wiring types.

Approved for direct burial in insulation.

CONSTRUCTION — Air-tight standard. Tested to meet current energy codes.

Aluminum housing with galvanized steel pan.

Galvanized bar hangers span up to 24" o.c. and feature stepped shank nail and positioning guide with integral T-bar locks. Two locking screws hold fixture in position.

Galvanized steel junction box with four built in romex clamps; five 1/2" and two 3/4" knockouts with slots for pryout. Rated for through branch wiring.

Maximum 4 (2in 2out) No 12 AWG conductors. Rated for 90° C.

Ground wire provided.

Removable J-box doors for easy access.

ELECTRICAL — Durable medium base porcelain socket with nickel plated copper alloy screw shell and contact.

Socket clips to top of housing to prevent paint overspray in socket screw shell.

Socket attaches to reflector to ensure proper and consistent lamp position.

Thermal protection provided against improper lamp usage.

120 volt only.

INSTALLATION — Air-tight housing suitable for air-tight installations. Refer to energy codes for proper mounting installations.

2 x 8 wood joist or T-bar installation.

Expandable bar hangers allow for off-center mounting in wood joist or T-bar ceilings. Length of 25-1/4" maximum 13-1/4" minimum or cut to fit 9" on center joist construction.

Vertical adjustment of housing allows for flush mounting with ceiling face.

Suitable for ceilings up to 1-1/2" thick.

LISTINGS — UL Listed to US and Canadian safety standards. Damp location listing (See trim selection for wet location listing).

WARRANTY — 1-year limited warranty. Complete warranty terms located at www.acuitybrands.com/CustomerResources/Terms_and_conditions.aspx

Note: Specifications subject to change without notice.

Catalog Number
Notes
Type

5" Housing

L5

INCANDESCENT
IC
New Construction

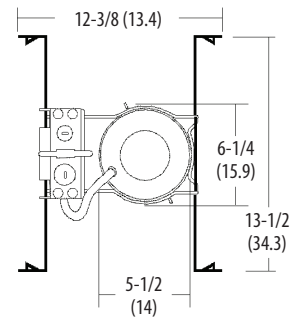
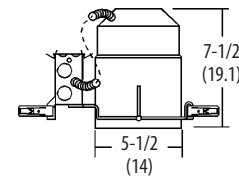

Specifications

Height: 7-1/2 (19.1)

Length: 13-1/4 (33.7)

Width: 12-7/8 (32.7)

Ceiling cutout: 5-1/2 (14)

All dimensions are inches (centimeters) unless otherwise indicated.

ORDERING INFORMATION For shortest lead times, configure product using **bolded options**.

Example: L5 R6









Series	Options	Packaging
L5	<u>Shipped installed in fixture</u> PHC Poke-home wire connector	R6 Resale pack of six U Unit

Accessories: Order as separate catalog number.	
ATK5	5" Airtight trim kit

Notes

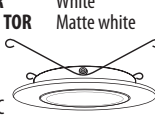
See trim summary on reverse side for maximum wattages.

L5 5" New Construction Housing

Description Catalog number	Maximum wattage ¹	Description Catalog number	Maximum wattage ¹	Description Catalog number	Maximum wattage ¹	Description Catalog number	Maximum wattage ¹
General/Task							
Open Wide Flange 501	White	Baffle Narrow Flange ⁴ 5B1 5B1W	Black White	Eyeball Narrow Flange 5E1 5E1MW 5E1ORB 5E1BZA 5E1BN	White Matte white Oil-rubbed bronze Antique bronze Brushed nickel	WETlite™ 5H20 TOR 5H20MW TOR 5H20ORB TOR 5H20BZA TOR 5H20BN TOR	White Matte white Oil-rubbed bronze Antique bronze Brushed nickel
IC/Non IC	 50 R20 65 BR30 75 PAR30	 50 R20 50 PAR20 75 PAR30 ²	IC/Non IC	 50 R20 65 BR30 50 PAR20 ³ 75 PAR30 ³	IC/Non IC	 75 PAR38	
Open Narrow Flange 502 TOR 502A PFMW TOR R6	White Diffuse, matte white plastic flange	Baffle Deep Narrow Flange 5B2 TOR 5B2W TOR 5B2MW TOR 5B2 TRMW TOR 5B2ORB TOR 5B2BZA TOR 5B2BN TOR	Black, white flange White Matte white Black, matte white flange Oil-rubbed bronze Antique bronze Brushed nickel	Gimbal 5G1 TOR 5G1MW TOR	White Matte white	Drop Lens Narrow Flange 5LD1	Opal
502MW TOR 502ORB TOR 502BZA TOR 502BN TOR	Matte white Oil-rubbed bronze Antique bronze Brushed nickel	 50 R20 (white only) 65 BR30 (white only) 75 PAR30 (white only) 50 PAR30 60 PAR38	IC/Non IC	 75 PAR30 ⁶	IC/Non IC	 40 A19	
Open Narrow Flange 502A 502AZ 502BLZ	Clear diffuse Clear specular anodized Black specular anodized						
 50 R20 65 BR30 75 PAR30 ² 75 PAR30 ²	IC/Non IC						
 50 R20 65 BR30 75 PAR30 ² 60 PAR38 ³	IC/Non IC						

Notes

- 1 Maximum wattage listed. Lower wattage lamps may be used.
- 2 Short neck.
- 3 Anodized finishes only.
- 4 Shallow trims may be used for lower lamp position.
- 5 Long neck.
- 6 Long or short neck.
- 7 Lens trim is wet location listed. All others are damp location.

L Series Baffle Wide flange (Damp location)



Example: 5B1MW LED
L5²

ORDERING INFORMATION For shortest lead times, configure product using **bolded options**.

5B1MW		LED		
Series/Finish		Lamp/Lumen ¹	Color temperature	Voltage
Series 5B1	5" baffle LED module	LED 600 lumens	(blank) 3000K	(blank) 120V
Finish MW	Matte white			

P Series Baffle Wide flange (Wet location)



Example: 5B1PMW LED
L5²

ORDERING INFORMATION For shortest lead times, configure product using **bolded options**.

5B1PMW		LED		
Series/Finish		Lamp/Lumen ¹	Color temperature	Voltage
Series 5B1	5" Baffle LED module	LED 620 lumens, 10.5 watts	(blank) 3000K	(blank) 120V
Finish MW	Matte white			

Notes

- 1 Total system delivered lumens.
- 2 L5 must be ordered on separate line.

L5 5" New Construction Housing

LED Gimbal (Damp location)



Example: 5G1MW LED
L5²

ORDERING INFORMATION For shortest lead times, configure product using **bolded options**.

5G1		LED		
Series/Finish		Lamp/Lumen ¹	Color temperature	Voltage
<u>Series</u> 5G1 5" Gimbal module	<u>Finish</u> MW Matte white MB Matte black BN Brush nickel ORB Oil-rubbed bronze	LED 600 lumens, 10.8 watts	(blank) 3000K	(blank) 120V

Notes

- 1 Total system delivered lumens.
- 2 L5 must be ordered on separate line.