



**ALUMINUM
FLUORO BAR SYSTEM**
T5 FLUORESCENT 3-WIRE
UNDERCABINET LIGHTING
ALFT5-21-3200-3



PROJECT
FIXTURE TYPE
MODEL
LAMP
CONTACT/TELEPHONE

Specifications

Description
Durable extruded aluminum fixture with Polycarbonate(PC) linear ribbed lens, in white enamel body only. ALFT5-21-3200-3 comes with an on/off switch and is complete with mounting hardware and a link connector.

- Lamp Wattage / Type**
- T5 Replaceable Triphosphor Fluorescent lamp
 - 21 Watts
 - CRI: 82+
 - Colour temperature: 3200K (Warm White)
 - Lamps are rated for average 10,000 hrs

- Features**
- Built-in Silent Electronic Ballast
 - Efficient T5 Fluorescent Light Source
 - Flicker free start up
 - Six available lengths
 - Can be hardwired (using ALFT6300)
 - Linkable
 - Light weight
 - Polycarbonate linear ribbed lens

Housing
Durable extruded aluminum fixture with Polycarbonate linear ribbed lens, in white paint enamel body only.

Mounting
Hardware provided for mounting fixture either to standard horizontal surface or to vertical wall surface.

Ballast: Built-in Silent Electronic Ballast, AC120V -50-60 Hz

Dimmable: Not Dimmable

- Optional Accessories**
- ALFT6300-WH - Hardwire Box
 - Flexible wire connectors, available in various lengths
 - FBT6106-WH-3 - 6" Connector Cable
 - FBT6100-WH-3 - 12" Connector Cable
 - FBT6124-WH-3 - 24" Connector Cable
 - FBT6136-WH-3 - 36" Connector Cable
 - Replacement lamp - T5-21W32
 - 6-ft. 90° power cords
 - ALFT60901-WH-3
 - ALFT60902-WH-3
 - ALFT60903-WH-3
 - ALFT60904-WH-3
 - 6-in 90° flexible connectors
 - ALFT90-WH-3
 - ALFT901-WH-3
 - ALFT902-WH-3
 - ALFT903-WH-3
 - Power cords
 - ALFT6000-WH-3 – 6-ft power cord
 - ALFT6000S-WH-3 – 6-ft power cord with switch
 - ALFT6200-3 – Rocker switch for power cords



Dimensions & Ordering Guide

MODEL NO.	Lumens
ALFT5-21-3200-3	1365

Dimensions

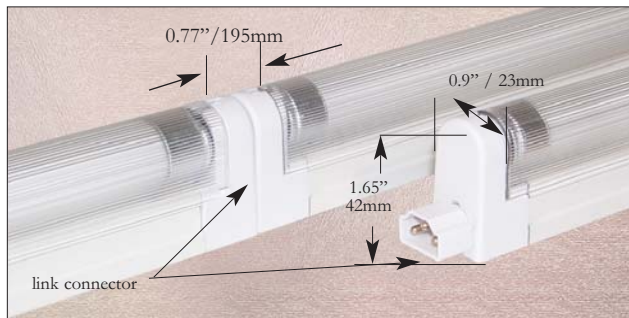
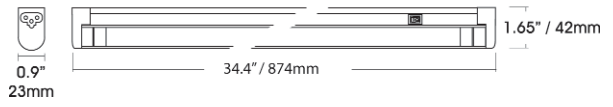

Linkable with a link connector

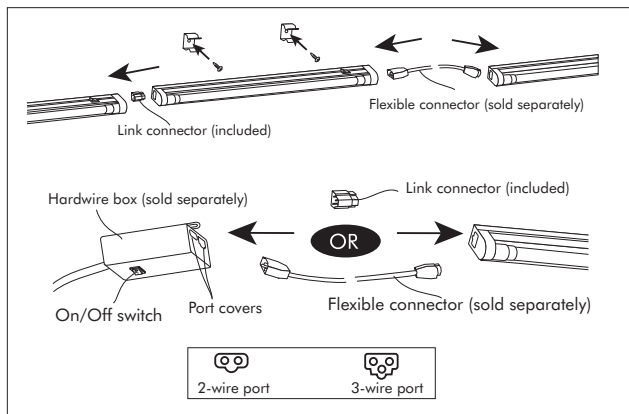

Linkable

T5 Linkable Fluorescent Fixtures
Up to 8 units can be linked together, not to exceed 150W max.



With Ordering Guide, replace 4100K with 3200K where necessary. e.g. For 3200K, (ALFT5-6-3200)

Product specifications subject to change without notice.

LITELINE CORPORATION
8 Abacus Road, Brampton, Ontario, Canada L6T 5B7
Tel: 416-996-1856 • Fax: 905-794-1990 / 1-888-738-9736
E-mail: sales@liteline.com • Website: liteline.com