



PAR220/20

ATHENA Line Voltage Track Fixture for PAR20 Lamps
Track Systems

Job Information		
Project Name		Type
Location		
Quantity		Date
Contact/Phone		
Notes		

Features

Body

Constructed of die cast aluminum which provides superior strength and rigidity. Softened edges adds up to the low profile aesthetic design.

Lamping

Porcelain socket for 120V PAR20 lamps, 50 watts max. A high temperature glass shield is included, mounted to front of lamp fixture.

Adjustability

Fixture provides vertical rotation of 90° and horizontal rotation of 330°; providing a wide range of light source aiming possibilities.

Dimming

The track fixture is dimmable when used with electronic line voltage rated dimming controls only. 120V / 60Hz input; 120V output; 50W maximum load.

Compatibility

Liteline track fixtures are compatible with Juno®, Halo®, Lightolier® and most brands configured to Halo® track system design.

Labels

- cULus listed.



Description

The ATHENA is an adjustable, lightweight, high-styled, exposed lamp design, line voltage track lighting fixture. ATHENA provides a rear load lamping and allows for directional light source for special aiming and assures secure lock on angle position.

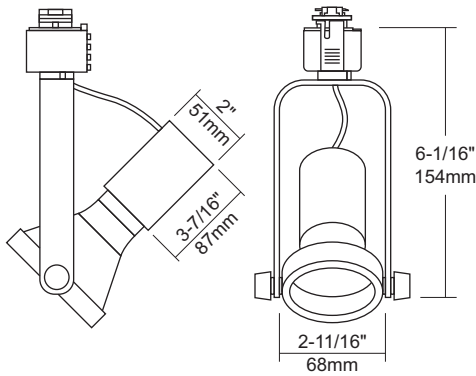

Connector Compatibility Chart



Notes: Accessories should be ordered separately. For additional options please consult your Liteline representative. Juno is a registered trademark of Juno Lighting Group. Halo is a registered trademark of Cooper Lighting. Lightolier is a registered trademark of Philips. Due to our continued efforts to improve our products, product specifications are subject to change without notice.

Ordering Guide



PAR220/20-BK
ATHENA black track fixture, 120V.



PAR220/20-BN
ATHENA brushed nickel track fixture, 120V.



PAR220/20-WH
ATHENA white track fixture, 120V.

Liteline Corporation
info@liteline.com
www.liteline.com

8 Abacus Road
Brampton, Ontario
Canada L6T 5B7

PHONE | TÉLÉPHONE
416-996-1856
1-866-730-7704

FAX | TÉLÉCOPIEUR
905-794-1990
1-888-738-9736

