

PACSystems* RX3i and Series 90*-30

IC694ALG442 and IC693ALG442

Analog Module, 4 Inputs/2 Outputs, Current/Voltage

GFK-2687A

May 2012

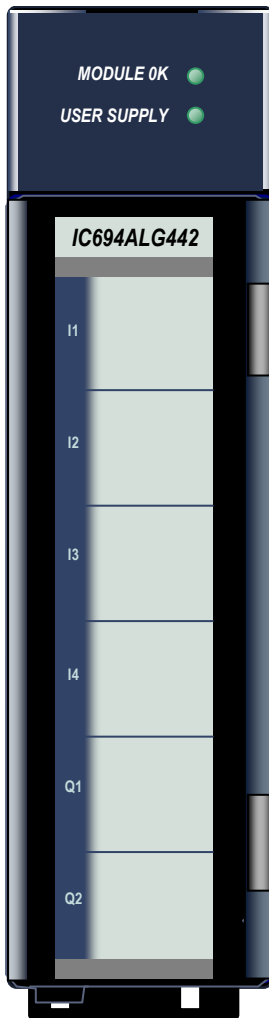

Analog Current/Voltage Input/Output module, ALG442, provides four differential input channels and two single-ended output channels. Each channel can be configured with the Machine Edition software for one of the following ranges:

- 0 to +10 volts (unipolar), default.
- -10 to +10 volts (bipolar)
- 0 to 20 mA
- 4 to 20 mA

Input channels can also be configured for 4 - 20 mA Enhanced mode.

This module may be installed in any I/O slot that has a serial connector in an RX3i or Series 90-30 system.

Module Features

Outputs can be configured to either Hold Last State or to reset to the low end of their range if system power is interrupted. Outputs can also be configured to operate in ramp mode on command from the application program. In ramp mode, the output channel transitions to a new value over a period of time, rather than taking the new value immediately.

High and low alarm limits can be set for all input channels and an open-wire fault (current output modes) can be reported to the CPU for each output channel.

ALG442 modules in RX3i racks support firmware upgrades in the field.

Isolated +24 VDC Power

This module requires 150 mA plus loop current(s) from a user-supplied +24 VDC supply.

LEDs

The **MODULE OK** LED provides module status information as follows:

ON: status is OK, module configured;

OFF: no backplane power or software not running (watchdog timer timed out);

Continuous rapid blinking: configuration data not received from CPU;

Slow blinking, then OFF: failed power-up diagnostics or encountered code execution error.

The **USER SUPPLY** LED indicates that the external 24 VDC supply is within specifications.

GFK-2687A

Specifications: ALG442

Power Requirements	
External Supply Voltage Range	20 to 30 VDC (24 VDC typical)
Power Supply Rejection Ratio	Current: 5 μ A/V (typical), 10 μ A/V (maximum) Voltage: 25 mV/V (typical), 50 mV/V (maximum) (Measured by varying V_{USER} from 24 VDC to 30 VDC)
Voltage Ripple	10%
Power Consumption	
	95 mA from internal +5 VDC Supply, 150 mA from external +24 VDC supply
Update Rate	
	Update Rate: 3 ms
Isolation, Field to Backplane (optical) and to Frame Ground	
	250 VAC continuous; 1500 VAC for 1 minute
Analog Outputs	
Two, Single-Ended	
<i>Analog Current Output</i>	
Output Ranges	0 to 20 mA, 4 to 20 mA
Resolution	0 to 20 mA: 0.6 μ A (1 LSB = 0.6 μ A) 4 to 20 mA: 0.5 μ A (1 LSB = 0.5 μ A)
Absolute Accuracy ^{1,5}	\pm 0.1% of full scale @ 25°C (77°F), typical \pm 0.25% of full scale @ 25°C (77°F), maximum \pm 0.5% of full scale over operating temperature range (maximum)
Maximum Compliance Voltage	$V_{USER} - 3$ V (minimum) to V_{USER} (maximum)
User Load	0 to 850 Ω (minimum at $V_{USER} = 20$ V, maximum 1350 Ω at $V_{USER} = 30$ V)
Output Load Capacitance	2000 pF (maximum)
Output Load Inductance	1 H (maximum)
<i>Analog Voltage Output</i>	
Output Ranges	-10 to +10 V (bipolar), 0 to +10 V (unipolar)
Resolution	-10 V to +10 V: 0.3125 mV (1 LSB = 0.3125 mV) 0 to +10 V: 0.3125 mV (1 LSB = 0.3125 mV)
Absolute Accuracy ^{2,5}	\pm 0.25% of full scale @ 25°C (77°F), typical \pm 0.5% of full scale @ 25°C (77°F), maximum \pm 1.0% of full scale over operating temperature range (maximum)
Output Loading	5 mA (2 K Ohms minimum resistance)
Output Load Capacitance	1 μ F (maximum capacitance)
Analog Inputs	
Four, differential	
<i>Analog Current Input</i>	
Input Ranges	0 to 20 mA, 4 to 20 mA, 4 to 20 mA Enhanced
Resolution	5 μ A (1 LSB = 5 μ A)
Absolute Accuracy ³	\pm 0.25% of full scale @ 25°C (77°F) \pm 0.5% of full scale over specified operating temperature range
Linearity	<1 LSB
Common Mode Voltage	200 VDC (maximum)
Common Mode Rejection	>70 dB at DC; >70 dB at 60 Hz
Cross Channel Rejection	>70 dB from DC to 1 kHz
Input Impedance	250 Ω
Input Filter Response	38 Hz

1 Analog Current output: In the presence of severe Radiated RF interference (IEC 61000-4-3, 10V/m), accuracy may be degraded to \pm 1% of full scale.

2 Analog Voltage output: In the presence of severe Radiated RF interference (IEC 61000-4-3, 10V/m), accuracy may be degraded to \pm 4% of full scale.

Specifications, continued

<i>Analog Voltage Input</i>	
Input Ranges	0 to +10 V (unipolar), -10 to +10 V (bipolar)
Resolution	0 to +10 V: 2.5 mV (1 LSB = 2.5 mV) -10 to +10 V: 5 mV (1 LSB = 5 mV)
Absolute Accuracy ^{4,5}	±0.25% of full scale @25°C (77°F); ±0.5% of full scale over specified operating temperature range
Linearity	<1 LSB
Common Mode Voltage	200 VDC (maximum)
Common Mode Rejection	>70 dB at DC; >70 dB at 60 Hz
Cross Channel Rejection	>70 dB from DC to 1 kHz
Input Impedance	800 K Ohms typical)
Input Filter Response	38 Hz

- 3 Analog Current Input: In the presence of severe Radiated RF interference (IEC 61000-4-3, 10V/m), accuracy may be degraded to ±2% of full scale.
- 4 Analog Voltage Input: In the presence of severe Radiated RF interference (IEC 61000-4-3, 10V/m), accuracy may be degraded to ±1% of full scale.
- 5 Applicable for all outputs and inputs: In the presence of severe Conducted RF interference (IEC 61000-4-6, 10Vrms), accuracy may be degraded to ±2% of full scale.

Refer to the applicable Installation or System manual for product standards, general operating specifications, and installation requirements:

Series 90-30 Installation Manual, GFK-0356

Series 90-30 systems: Installation Requirements for Conformance to Standards, GFK-1179

PACSystems RX3i System Manual, GFK-2314

GFK-2687A

Field Wiring: ALG442

The diagram below shows voltage and current connections for the module. Each channel can be configured independently as a voltage or a current channel, not both simultaneously.

Terminal	Signal	Definition
1	24VIN	User Supplied +24 VDC Input
2	JMP1	Jumper terminal for connecting 250Ω sense resistor for CH1 current mode
3	JMP2	Jumper terminal for connecting 250Ω sense resistor for CH2 current mode
4	+CH1	Positive connection for differential analog input channel 1
5	+CH2	Positive connection for differential analog input channel 2
6	-CH1	Negative connection for differential analog input channel 1
7	-CH2	Negative connection for differential analog input channel 2
8	JMP3	Jumper terminal for connecting 250Ω sense resistor for CH3 current mode
9	JMP4	Jumper terminal for connecting 250Ω sense resistor for CH4 current mode
10	+CH3	Positive connection for differential analog input channel 3
11	+CH4	Positive connection for differential analog input channel 4
12	-CH3	Negative connection for differential analog input channel 3
13	-CH4	Negative connection for differential analog input channel 4
14	V _{out} CH1	Voltage output for channel 1
15	I _{out} CH1	Current output for channel 1
16	V _{out} CH2	Voltage output for channel 2
17	I _{out} CH2	Current output for channel 2
18	V COM	Common return for voltage outputs
19	I RET	Common return for User supplied +24 V and current outputs
20	GND	Frame ground connections for cable shields

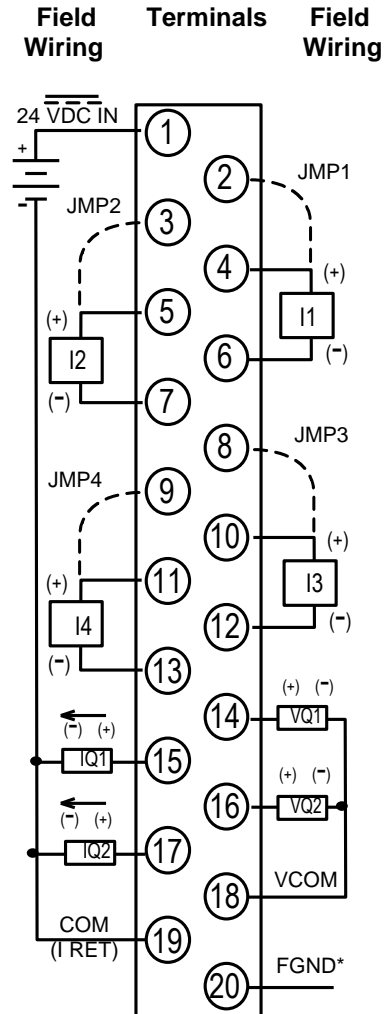

* Optional Shield Connection

Configuration: ALG442

The following module parameters can be configured using the Machine Edition software.

Module Settings

Parameter	Choices	Description
Stop Mode	Hold (default) or DeFlow	Output state when module goes from Run to Stop mode. If the configured Stop Mode is <i>Hold</i> , the module holds outputs at the last state received from the CPU. If the Stop Mode is <i>Default Low</i> , the outputs will go to their low values as follows: Current mode (4-20 mA): outputs go to 4 mA Current mode (0-20 mA): outputs go to 0 mA Voltage mode (unipolar (0 to +10V) and bipolar (+10V to -10V): outputs go to 0V
Input Channel Value Reference Address	Valid memory type: %AI	Starting %AI address for the module's analog input data
Input Channel Value Reference Length	Read-only	Each input channel provides 16 bits (1 word) of analog input data to the Controller CPU.
Output Channel Value Reference Address	Valid memory type: %AQ	Starting %AQ address for the module's analog output data
Output Channel Value Reference Length	Read-only	Each input channel receives 16 bits (1 word) of analog input data to the Controller CPU.
Module Status Reference Address	Valid memory type: %I	Starting %I address for the module's status data
Module Status Reference Length	0 (Module status reporting Disabled) 8 (module and power status only) 16 (above plus input status) 24 (all above plus output status)	Number of status bits (0 to 24) that will be used for module and channel status data. When set to 0, status reporting is disabled. To enable status reporting, set this parameter to a value other than 0. For data format, see page 8.
I/O Scan Set	1 through 32	Assigns the module to an I/O Scan Set defined for the CPU.

Output Channel Data

Parameter	Choices	Description
Output Range	0 to +10 V, -10 to +10 V, 4 to 20 mA, 0 to 20 mA	Type of output range.

Input Channel Data

Parameter	Choices	Description
Input Range	0 to +10 V, -10 to +10 V, 4 to 20 mA, 0 to 20 mA, 4 to 20 mA Enhanced	Type of input range
Alarm Low Limit	-32768 to 32759	Low limit alarm value for each input. Must be less than the same channel's high alarm.
Alarm High Limit	-32768 to 32760	High limit alarm value for each input. The Alarm Low and Alarm High parameters can be used to set up limits that cause alarms to be passed to the Controller for each channel. Values entered without a sign are assumed to be positive. These configured alarm limits are stored until changed by a new configuration. The configured high and low alarm limits can be changed temporarily by a COMM_REQ command.

GFK-2687A

Input Scaling

Resolution per bit depends on the configured input or output range as shown in the table of module specifications. The module scales each current and voltage input to a value in counts for the CPU.

Configured Range	Scaled Counts Values
0 to 10 V (default)	0 to 32767
-10 to 10 V	-32768 to 32767
4 to 20 mA	0 to 32767
0 to 20 mA	0 to 32767
4 to 20 mA Enhanced	-8000 to 32,767

In the 0 to +10 V default range, 0 volts corresponds to a count of 0 and +10 volts corresponds to a count of 32000. In the -10 to +10 volt range, -10 volts corresponds to a count of -32000 and +10 volts corresponds to a count of +32000. Full 12-bit resolution is available over either range.

In the 4 to 20 mA range, 4 mA corresponds to a count of 0 and 20 mA corresponds to a count of 32000. In the 0 to 20 mA range, 0 mA corresponds to a count of 0 and 20 mA corresponds to a count of 32000. Full 12-bit resolution is available over the 0 to 20 mA range. The module allows an overrange of 32001 to 32767.

In the 4 to 20 mA Enhanced range, 0 mA corresponds to a count of -8000, 4 mA corresponds to a count of 0 (zero) and 20 mA corresponds to a count of +32000. The Enhanced range automatically provides 4 to 20 mA range scaling. Negative digital values are provided for input current levels between 4 mA and 0 mA. This creates a low alarm limit that detects when the input current falls from 4 mA to 0 mA, providing open-wire fault detection in 4 to 20 mA applications.

Input Voltage Scaling

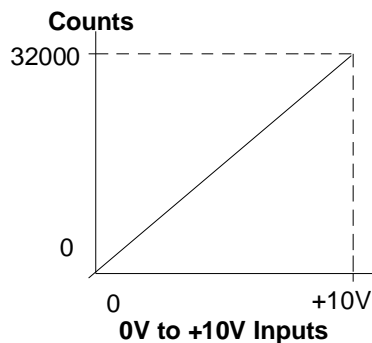

Input Current Scaling

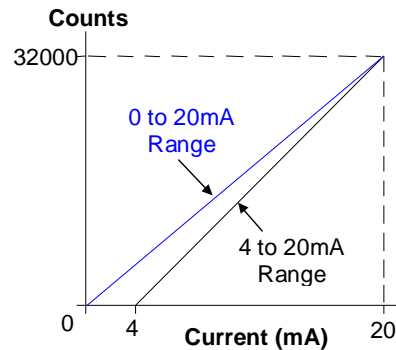

If the current source is reversed into the input, or is less than the low end of the current range, the module inputs a data word corresponding to the low end of the current range (0000H in %AI). If an input is out of range (greater than 20 mA), the A/D converter adjusts it to full scale (corresponding to 7FFFH in %AI).

Output Scaling

The module scales counts data received from the CPU to a current or voltage value for each output.

Configured Range	Values Sent By CPU	Values Accepted by Module
0 to 10 V (default)	0 to 32767	0 to 32767
-10 to 10 V	-32768 to 32767	- 32768 to 32767
4 to 20 mA	0 to 32767	0 to 32000
0 to 20 mA	0 to 32767	0 to 32767

For a 0 to 10 V output, the module scales count outputs from 0 to 32000 to output voltages from 0 to +10 volts. The module scales count values from 32001 to 32767 to overrange voltages up to a maximum of approximately 10.24 volts.

For a -10 to +10 V output, the module scales count outputs in the range ± 32000 to output voltages from -10 V to +10 V. The module scales count values from -32001 to -32768 and from +32001 to +32767 to overrange voltages up to a maximum of approximately ± 10.24 V.

For a 4 to 20 mA output, the module scales count outputs from 0 to 32000 counts to output currents from 4 to 20 mA. If the CPU sends a value above 32000 counts, the module truncates the value to 32000 in the D/A converter. No error is returned.

For a 0 to 20 mA output, the module scales count outputs from 0 to 32000 to output currents from 0 to 20 mA. The module scales count values from 32001 to 32767 up to a maximum output current of approximately 20.5 mA.

Output Voltage Scaling

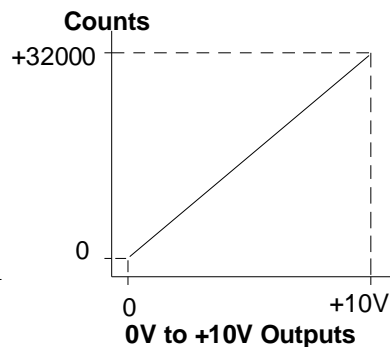
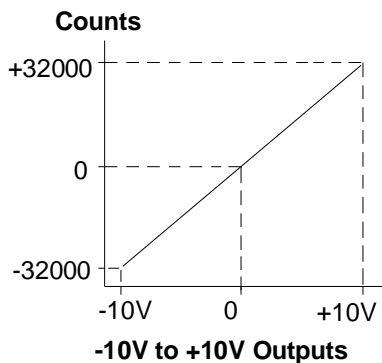

Output Current Scaling

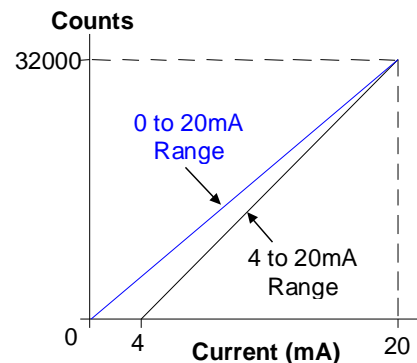

I/O Data: ALG442

This module uses two %AQ references and four %AI references, depending on configuration. Data in the %AI and %AQ registers is in 16-bit 2's complement format. The module also uses 8, 16 or 24 %I references for status data, depending on the alarm status configuration. Status data format is shown on the next page.

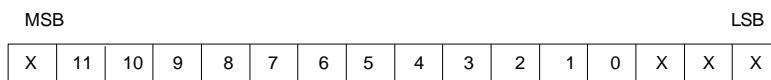

Input Data

Resolution of the converted signal is 12 bits binary (1 part in 4096). The placement of the 12 bits from the A/D converter in the %AI data word is shown above.

The bits in the %AI data table that were not used are forced to 0 (zero) by the analog input channel.

Output Data

Each output channel is capable of converting 15 to 16 bits (depending on the range selected) of binary data to an analog output.

GFK-2687A

Status Data: ALG442

The Analog Module can be configured to return 8, 16, or 24 status bits to the Controller CPU.

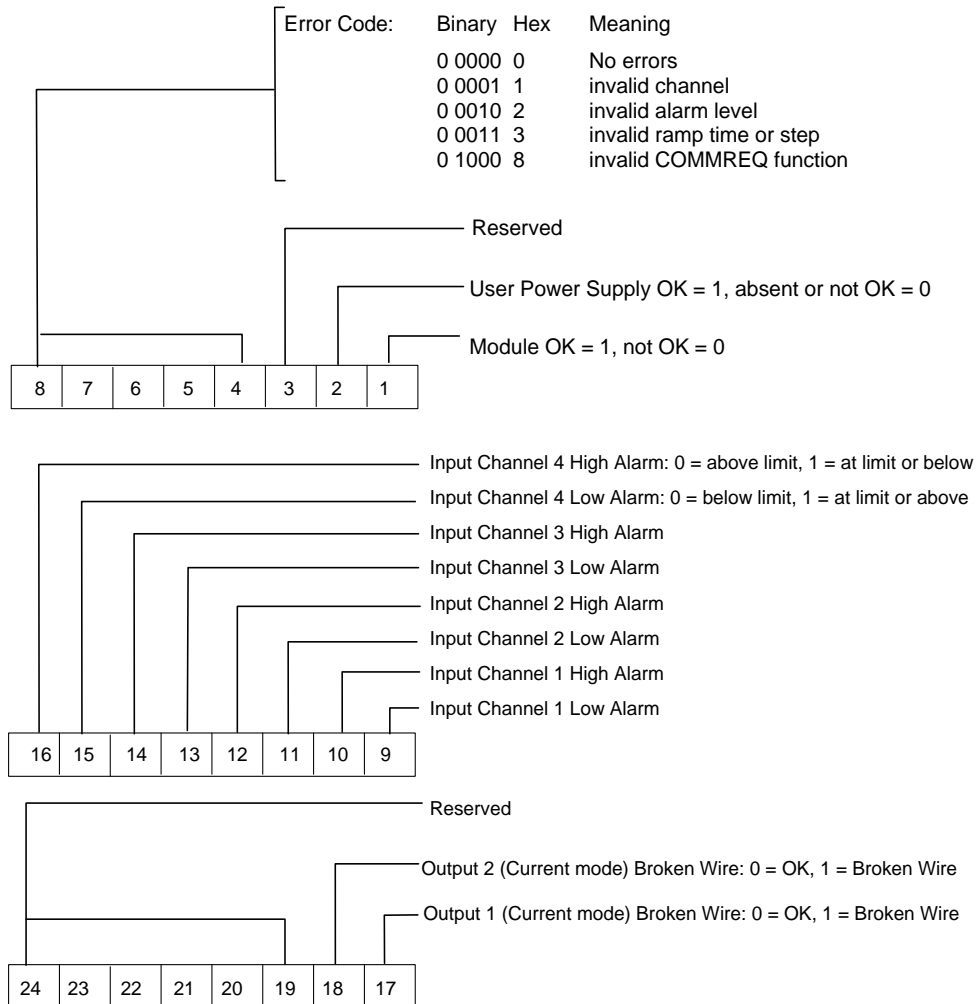
**Error Code**

Byte 1 of the status data contains a status/error code for COMM_REQs sent to the module. Only the most recent error is reported; an existing error code will be overwritten if another error occurs. The priority of errors is:

1. Invalid COMM_REQ function (highest priority)
2. Invalid channel.
3. Invalid data (ramp or alarm parameter) (lowest priority).

If multiple errors occur, the one with the highest priority is reported in the error code. The module will not stop standard operation if an error is detected; these error bits are informational only, and can be ignored.

Ramp Mode Operation for ALG442

Outputs on module ALG442 can be set up to operate in Ramp mode using a COMM_REQ command. In normal operating mode, a new value entered in an output channel's %AQ reference causes the output to change directly to the new value. In Ramp mode, the output goes to the new value over a period of time. The output channel starts a new ramp (either up or down) each time the value in its %AQ reference changes. The module performs range checking on new output values and automatically adjusts out-of-range values before making the ramp computations.

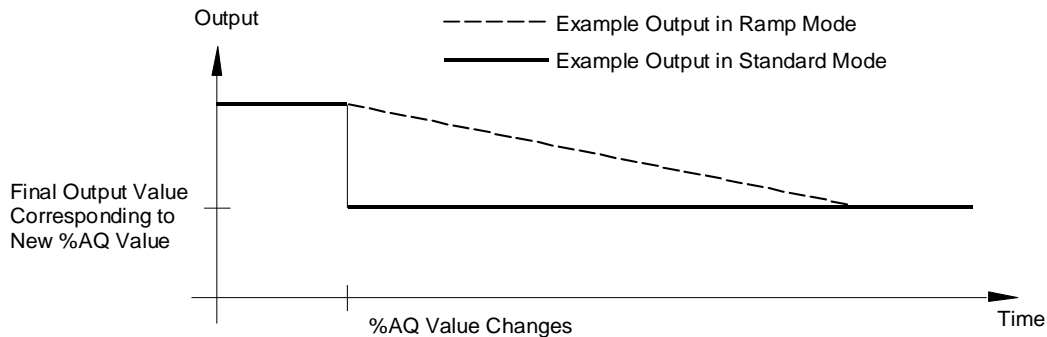

Use of Ramp mode is set up for either channel or both output channels using a COMM_REQ command. The ramp slope can be set up in the COMM_REQ as:

- a total ramp time from 1 millisecond to 32 seconds, or:
- a sequence of 1 to 32000 1-millisecond steps.

A channel stays in Ramp mode until the module receives a new COMM_REQ either changing or canceling the ramp operation, or until power is cycled. The channel will not change modes after a hardware configuration download. Because COMM_REQ settings are temporary, it will be lost after a power cycle.

If the module receives a new COMM_REQ that changes ramp operation while an output is in the process of ramping, the new ramp settings take effect as follows:

- If Ramp mode is turned off during a ramp, the channel goes directly to the value in its %AQ reference.
- If a channel is set up to ramp over a period of time, but a new COMM_REQ is received commanding the channel to instead ramp in a sequence of measured steps, ramp operation changes as soon as the COMM_REQ is processed (assuming that the step is valid).
- If a channel is set up to ramp as a sequence of measured steps, but a new COMM_REQ is received commanding the channel to instead ramp over a period of time, it immediately starts a new ramp using the present output as the starting output and the present time as the start time.

If the module receives a Ramp command for an invalid channel, step height or ramp time, the module ignores the command and returns an error code in the first byte of its %I status references. The error code can be cleared by a Clear Errors COMM_REQ, or by reconfiguring the module.

GFK-2687A

Changing Module Operation on Command

The ALG442 can respond directly to a specific COMM_REQ command from the application program to:

- clear the module's %I error code
- modify the Input alarm limits, and
- put one or both outputs in Ramp mode and set up the ramp characteristics

The Task input to the COMM_REQ function must be zero.

COMM_REQ Format

Module ALG442 can respond directly to a specific COMM_REQ (Communication Request) command from the application program to:

1. Clear the module's %I error code.
2. Modify the Input alarm limits, and.
3. Put one or both outputs in Ramp mode and set up the ramp characteristics.

These changes to module are not retained during loss of power. If the module is power-cycled, new commands must be sent to the module to again modify the configured alarm limits, or to set up Ramp operation for the outputs.

COMM_REQ Command Block

The format of the COMM_REQ for module ALG442 is shown below. For more information about using COMM_REQs, see the online help and the *PACSystems CPU Reference Manual*, GFK-2222.

Word Offset	Value	Description
Word 1	Must be 0004	Length of the command block
Word 2	0000	Not used
Word 3	(See below)	Memory type of COMM_REQ Status Word
Word 4	0-based.	Offset of COMM_REQ Status Word
Word 5	0	Reserved
Word 6	0	Reserved
Word 7	E201H (-7679 decimal)	COMM_REQ command number
Word 8	0006	Byte length of Command Data (see below)
Word 9	(See below)	Memory type in the CPU for the Command Data
Word 10	0-based	Memory offset for the Command data

Memory Types and Offsets

The COMM_REQ Command Block specifies a memory type and location to receive status information about the execution of the command (word 3), and for the command data (word 9). The memory types are listed in the table below.

Type	Value (Decimal)	Value (Hex)
%R (word mode)	8	08H
%AI (word mode)	10	0AH
%AQ (word mode)	12	0CH
%I (byte mode)	16	10H
%I (bit mode)	70	46H
%Q (byte mode)	18	12H
%Q (bit mode)	72	48H

Type	Value (Decimal)	Value (Hex)
%T (byte mode)	20	14H
%T (bit mode)	74	4AH
%M (byte mode)	22	16H
%M (bit mode)	76	4CH
%G (byte mode)	56	38H
%G (bit mode)	86	56H
%W	196	C4H

COMM_REQ Command Data Format

In the COMM_REQ Command Block (above) words 9 and 10 assign a CPU memory location for six bytes of command data. The program logic can use these bytes to set the parameters of the COMM_REQ. This module does not use the last command data word.

word 1	Command word
word 2	Alarm or ramp data
word 3	Unused for module ALG442

Command to be Performed	Word 1 Contains	Word 2 Contains
Change the specified input's low alarm limit to the value in word 2.	0000 (Input 1) 0001 (Input 2) 0002 (Input 3) 0003 (Input 4)	New low alarm limit for the input
Change the specified input's high alarm limit to the value in word 2.	0010 (Input 1) 0011 (Input 2) 0012 (Input 3) 0013 (Input 4)	New high alarm limit for the input
Change the specified input's low alarm limit by the increment in word 2.	0020 (Input 1) 0021 (Input 2) 0022 (Input 3) 0023 (Input 4)	Increment to change the input's configured low alarm limit. Increment can be + or -.
Change the specified input's high alarm limit by the increment in word 2.	0030 (Input 1) 0031 (Input 2) 0032 (Input 3) 0033 (Input 4)	Increment to change the input's high alarm limit. Increment can be + or -.
Turn off Ramp operation for the specified output channel and put it in normal mode.	0040 (Output 1) 0041 (Output 2)	--
Put the specified output channel in Ramp step mode. Step increment in word 2.	0050 (Output 1) 0051 (Output 2)	Step (1 to 32000 counts) to be taken each millisecond.
Put the specified output channel in Ramp time mode. Ramp total time in word 2.	0060 (Output 1) 0061 (Output 2)	Time in milliseconds: 1 to 32000 (1 ms to 32 seconds)
Clear the module's %I error code	00C0	--

If the requested command is not valid (for example, if the changed alarm limit would be out of range) the module ignores the COMM_REQ command and returns an error code in the module's %I status data. The module does **not** stop operating; these error bits are informational only and can be ignored. The error code remains in the %I status bits until cleared by another COMM_REQ (command 00C0, see directly above), or until the module is reconfigured.

GFK-2687A

Release History

Version	Firmware Release	Date	Description
IC694ALG442-CB IC693ALG442-EB	1.60	May 2012	Resolves several rarely-occurring issues that were identified in field and factory testing.
IC694ALG442-BA IC693ALG442-DA	1.1	Sep. 2011	Adds ability to perform field upgrades in RX3i targets. Adds display of module serial number, revision and Manufacturing date code in programming software in RX3i targets. Resolves issue with Ramp operation.

Important Product Information for this Release

Upgrades

Note: Only ALG442 modules in RX3i racks support firmware upgrades in the field. The firmware of ALG442 modules cannot be upgraded in Series 90-30 systems.

An upgrade kit containing firmware version 1.60, 41G1486-MS10-000-A1, is available for download at <http://ge-ip.com/support>.

Compatibility

The new version of the ALG442 is fully compatible with earlier versions of the ALG442 module, except the new version does not support the Series 90-30 Hand-Held Programmer.

Programmer version requirements	Proficy Machine Edition version 6.50 SIM 5 or later is required to configure the ALG442. Dependency on new PME due to change in power requirement of new module.
CPU firmware requirements	<i>RX3i:</i> All versions of the RX3i CPUs support the ALG442. <i>Series 90-30:</i> The ALG442 is compatible with all versions of CPU models 311 and higher, and NIU004. To support firmware upgrade feature for ALG442 on an Rx3i system, CPU firmware should be <i>PACSystems RX3i CPU Version 6.7 and above</i> .
Power requirements	The new ALG442 requires 150 mA from the external 24 V supply. Earlier versions required 129 mA from the external 24 V supply.

Restrictions and Open Issues

Subject	Description
Loss of I/O fault is logged for analog modules when a Clear All Memory command is sent through the RX3i CPU's serial port.	When the Rx3i CPU has more than three analog modules in a rack, PME is communicating with serial port and sends a Clear All Memory command, then any module may unexpectedly log a Loss of I/O Module fault. To recover from this issue, power cycle the CPU and download configuration. Or while clearing, do not use Clear All, but select the configuration item checkboxes.
Constant Sweep Exceeded fault is logged when ALGxxx modules are located in different racks, with at least one ALGxxx in a remote rack.	With the CPU in constant sweep mode, if two or more ALG modules are placed in a system such that one ALG module is in a remote expansion rack and the others are elsewhere in the system –either in the main rack, a local expansion rack, or a remote rack—as soon the hardware configuration is downloaded and the CPU is returned to run mode, the CPU logs a fault stating "Constant sweep exceeded" in the Controller fault table .

Operational Notes

Subject	Description
Field Wiring descriptions for jumpers is revised.	The Field Wiring descriptions for JMP1, 2, 3, 4 of ALG442 are revised to specify that the jumpers should be used only for current mode. See page 4. This information will be included in the next revision of the <i>PACSystems RX3i System Manual</i> GFK-2314D.
Current consumption from 24V supply is more than earlier hardware versions	Current consumption from the 24VDC external user supply for modules (IC694ALG442-BA and IC693ALG442-DA) is 150mA instead of 129mA for IC694ALG442Ax and IC693ALG442Cx.

Installation in Hazardous Areas

The following information is for products bearing the UL marking for Hazardous Areas or ATEX marking for explosive atmospheres:

- EQUIPMENT LABELED WITH REFERENCE TO CLASS I, GROUPS A, B, C & D, DIV. 2 HAZARDOUS AREAS IS SUITABLE FOR USE IN CLASS I, DIVISION 2, GROUPS A, B, C, D OR NON-HAZARDOUS LOCATIONS ONLY
- WARNING - EXPLOSION HAZARD - SUBSTITUTION OF COMPONENTS MAY IMPAIR SUITABILITY FOR CLASS I, DIVISION 2;
- WARNING - EXPLOSION HAZARD - WHEN IN HAZARDOUS LOCATIONS, TURN OFF POWER BEFORE REPLACING OR WIRING MODULES; AND
- WARNING - EXPLOSION HAZARD - DO NOT CONNECT OR DISCONNECT EQUIPMENT UNLESS POWER HAS BEEN SWITCHED OFF OR THE AREA IS KNOWN TO BE NONHAZARDOUS.

ATEX Marking

II 3 G Ex nA IIC T4 X Ta: 0 - 60C