

I/O Terminal Block with Barrier Terminals

GFK-1000G
August 2008

IC670CHS001
IC670CHS101

Description

I/O Terminal Blocks are generic wiring bases that provide module mounting, backplane communications, and terminals for user connections. Two modules can be installed on one terminal block. Modules screw onto the terminal block for vibration resistance. Modules can be removed without disturbing field wiring.

The I/O Terminal Block with barrier terminals (catalog number IC670CHS001/101) has 37 terminals. The A and B terminals are typically used for power connections to the terminal block. The rest of the terminals are individual terminals used for I/O wiring.

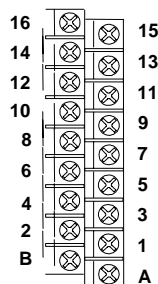

[Note: The wiring information in this datasheet supercedes wiring information in the *Field Control Distributed I/O and Control System I/O Modules Manual*, GFK-0826J or earlier.]

Each terminal on an I/O Terminal Block or Auxiliary Terminal Block with Barrier Terminals accommodates one #14 - 22 AWG solid or stranded, two #22 AWG solid, two #22 AWG stranded, two #14 AWG solid, or two # 14 AWG stranded wires. Do not mix solid and stranded wires on one terminal). Use copper wire rated for 90 degrees C. Recommended terminal torque is 8-9 in/lbs.

The safety ground wire should be AWG #14 (avg 2.1mm² cross section), not more than 4 inches (10.16 cm) long.

I/O Terminal Block IC670CHS101 permits hot insertion/ removal of modules without affecting the Bus Interface Unit or other modules in the I/O Station. Hot insertion/removal can only be performed in non-hazardous locations.

Wiring for I/O Modules

In general, I/O wires and communications bus cable can be placed randomly in a wiring trough for lengths of up to 50 feet. If wiring is cord-tied (harnessed), do not include the bus cable in the harness, since binding wires tightly together increases the coupling and mechanical stress that can damage the relatively soft insulation of some serial cable types. For more information about noise immunity, please refer to the *I/O Modules User's Manual*.

Power Wiring

I/O modules require field-side power for I/O devices. Power supply connections can easily be "daisy-chained" between modules with similar power requirements. Alternatively, separate supplies can be used on any combination of modules to provide isolation as needed.

Suppression at the Output Load: For information about suppression, please refer to the *I/O Modules User's Manual*.

Compatibility

I/O Terminal Block IC670CHS101 has a projecting alignment slot at each module position. It must be used with modules whose catalog number suffix is J or above. These modules have a projecting tab that fits into the alignment slot.

Bus Interface Unit version 2.1 or later is required for hot insertion/removal of modules in the I/O Station.

Mixing IC670CHS10x terminal blocks with IC670CHS00x terminal blocks in the same I/O station is not recommended.

Caution

I/O Terminal Blocks IC670CHS101 and IC670CHS001B or later have a metal grounding strip underneath. They must be used with a grounded conductive DIN rail. Do not use these terminal blocks with A version I/O Terminal Blocks or BIU Terminal Block IC670GBI001, which do not have a metal grounding strip; the system would have poor noise immunity.

Installation in Hazardous Locations

Warnings

- 1. This equipment is suitable for use in Class I, Division 2, Groups A, B, C, and D or in non-hazardous locations only.**
- 2. WARNING-Explosion Hazard-Substitution of components may impair suitability for Class I, Division 2.**
- 3. WARNING-Explosion Hazard-Do not disconnect equipment unless power has been switched OFF or the area is known to be non-hazardous.**

When in hazardous locations, turn off power before replacing or wiring modules. Do not remove or insert external modules with power applied. Personal injury, system malfunction and/or damage to the equipment may occur.

In non-hazardous locations, for personal safety field power should be off while removing or inserting a high-voltage I/O module. Avoid contact with module wiring and with the exposed connectors on the I/O Terminal Block.

GFK-1000G

Installing a Terminal Block on a DIN Rail

A new I/O Terminal Block is protected by a pair of sturdy labels. Keep these labels in place while installing the terminal block to prevent environmental contamination of block components. Follow the steps below to install the terminal block on a DIN rail.

1. Tilt the I/O Terminal Block and position it over the rail, catching the rail behind the tabs in the terminal block.
2. Pivot the terminal block downward until the spring-loaded latches click into place.

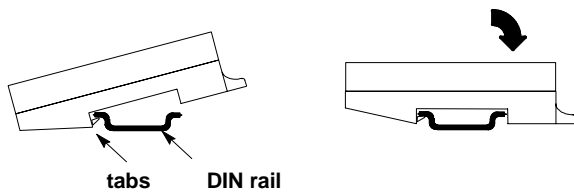

3. Tighten the DIN rail clamp screw. Recommended torque is 4 in/lbs to 6 in/lbs.

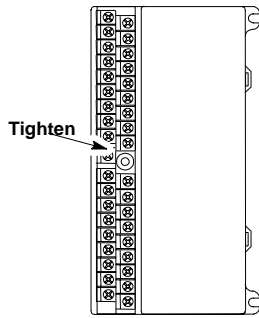

Removing the I/O Terminal Block from a DIN Rail

If Auxiliary Terminal Blocks are present, they must be taken off before the I/O Terminal Block can be removed from the DIN rail. Then follow the steps below to remove the I/O Terminal Block.

1. Loosen the DIN rail clamp screw.
2. Insert a small flat-blade screwdriver into the upper latch and pry it outward.
3. Pull up gently on the top of the terminal block to disengage the upper latch from the rail. Insert the screwdriver into the lower latch and pry it outward to free the terminal block.

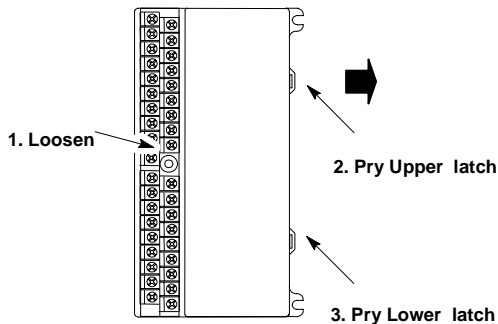

Connecting Bases

Before installing modules on their terminal blocks, install the connecting cable(s). The cable illustrated below is supplied with the I/O Terminal Block. A set of three connecting cables is available as renewal part number IC670CBL001. Optional 21-inch (0.53 meter) cable is also available (only one longer cable can be used per I/O station).

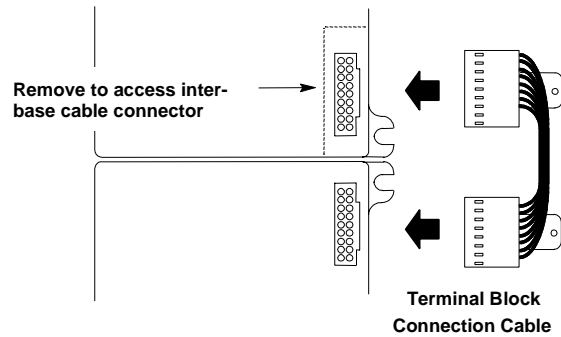

The connectors are keyed to assure proper installation. **After installing the cable, be sure it is firmly seated on both connectors.**

Auxiliary I/O Terminal Blocks

Auxiliary Terminal Blocks which have all terminals shorted together are used to provide extra ground, return, or common connections. They are available with box-type (IC670TBM002) or barrier-type terminals (catalog number IC670TBM001). The maximum current through any one terminal is 10 Amps.

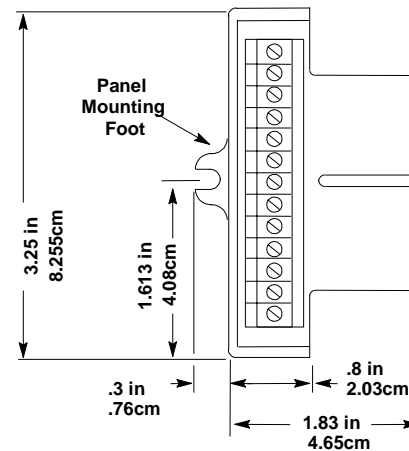

The I/O Terminal Block must be mounted on the DIN rail before installing an Auxiliary Terminal Block.

Installing an Auxiliary Terminal Block

To install an Auxiliary Terminal Block, slide the tabs into the slots underneath the I/O Terminal Block. Push **firmly** until the Auxiliary Terminal Block clicks into place.

Inserting an Auxiliary Terminal Block (seen from underneath)

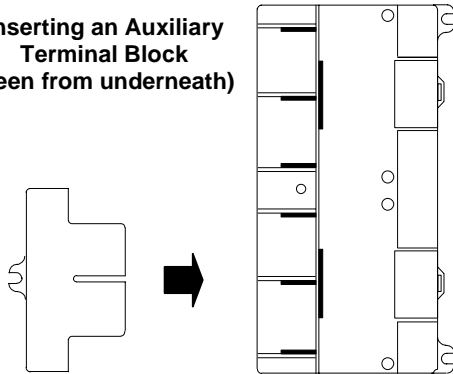

I/O Module Keying (optional)

The I/O Terminal Block is provided with a set of small keys that fit into lettered slots on the terminal block. Use of keying is recommended to ensure installation of the correct type of module in each location.

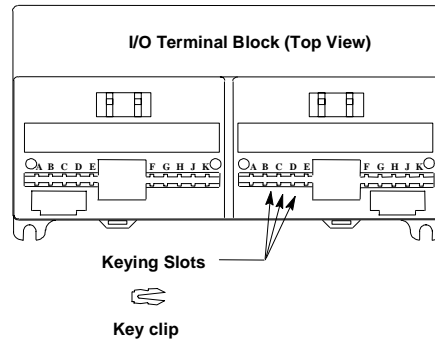

Removing an Auxiliary Terminal Block

To remove an Auxiliary Terminal Block, raise it upward then pull it out.

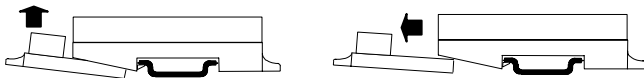

Refer to the following table for keying locations for various types of I/O modules. The check marks in the table correspond to the keying slots in the I/O Terminal Block.

Module ID: IC670...	Keying Locations										
	A	B	C	D	E	F	G	H	J	K	
MDL240		•			•		•	•			
MDL241			•		•		•		•		
MDL330, MDL331		•			•	•		•			
MDD441, MDL640, MDL644	•		•				•	•			
MDL641		•		•			•	•			
MDL642	•				•		•	•			
MDL643	•	•					•	•			
MDL730, MDL740, ALG320, ALG330	•		•						•	•	
MDL233		•			•	•			•		
MDL742	•	•						•		•	
MDL930			•	•	•	•	•	•			
ALG230, ALG240	•			•			•	•			
ALG630, ALG620	•			•				•	•		
ALG310	•			•					•	•	

GFK-1000G

Module Installation

Caution

Electrostatic discharge can damage an I/O Module when it is not installed on an I/O Terminal Block. Always observe good ESD protection practices when handling an un-installed module.

If the protective label is still in place on the I/O Terminal Block, remove it before attempting to install an I/O Module.

Installing an I/O Module on the Base

1. Before installing a module, remove the cable slot knockout(s) where the module would cover the connecting cable. The knockouts can be removed with pliers or by pressing *out* from inside the housing.
2. To install an I/O module, position the module so that the cable slot in the module housing is over the connecting cable.

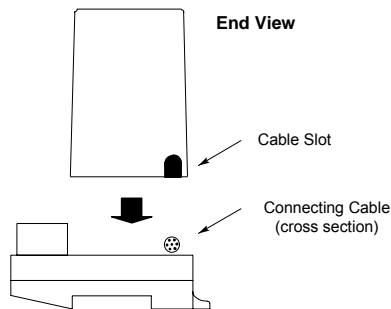

3. Align the module with the base and press the module down firmly. If you feel resistance, remove the module and check the keying (if present). Also be sure the connecting cable is within the cable slot.
4. Tighten the module bolts to secure it. Minimum recommended torque is 6 in/lbs. Maximum recommended torque is 9 in/lbs.

Removing Power

For I/O Terminal Blocks without the special alignment slot (IC670CHS001, 002, and 003), inserting or removing an I/O module during station operation may cause incorrect data to be generated for the entire I/O station.

I/O Terminal Blocks with the projecting alignment slot (IC670CHS101, 102, 103) are designed for module hot-insertion. With these terminal blocks, modules can be inserted/removed without removing power to the I/O station or affecting other devices in the I/O station. External power to the module itself must be removed for hot insertion/removal. Hot insertion/removal can only be performed in non-hazardous locations.

Note: Inserting or removing an I/O module during station operation may cause incorrect data to be generated.

Some Field Control modules may not make proper connection and fail to power up when hot-inserted on Terminal Block IC670CHS101B or earlier. Version IC670CHS101C (introduced in October 2004) or later should be used instead.