



Wiremold

ALA3800 Series Isoduct™ Aluminum Raceway

Aluminum Single Channel Raceway

Available Factory Prewired.





Wiremold Isoduct™ ALA3800 Series Aluminum Raceway System meets the demands of commercial spaces, providing a handsome and effective method of directing power or communications services where required. The low-profile surface mounted raceway is easy to install and because of its two-piece design, wiring is always accessible and changes are easily accomplished.



The low profile design of ALA3800 Series Raceway accommodates power or communication services.

FEATURES & BENEFITS

- **Single-Channel, Single-Cover, 2 1/4" [57mm] deep aluminum raceway.** Accommodates high density communication cabling for networks and phone systems.
- **Snap fit cover.** Provides maximum flexibility for adding or relocating circuits, data openings or electrical devices. Side removal slots limit visibility of any accidental marring during cover removal. Shares cover plates with Wiremold ALA4800 Series Raceway.
- **Cable bend radius control inserts.** Provides a 2" [51mm] bend radius for Fiber Optic/Cat 5 installations.
- **Durable, architectural clear anodized finish.** Wipes clean and resists corrosion. Custom colors available upon request. Consult factory for more information.
- **Accommodates standard electrical wiring devices.** Accommodates most installations including single outlets, duplex outlets, NEMA-Locking outlets, GFCI outlets, and Pass & Seymour surge protected outlets.
- **Electrical device identification with self-adhesive polyester labels or optional engraving.** No guesswork or time consuming tracing of circuits. Speeds circuit additions and renovations. (See Device and Raceway labeling Options)
- **Mitered standard fittings.** Provides a complete installation.
- **Increased productivity for the contractor.** Jobs can be packaged by area, floor, or building and shipped per job site requirements.
- **UL5 and ADA Compliant.** Raceway and fittings meet UL5 specifications and can be installed in conformance with ADA requirements.
- **Prewired connectors.** Available in 3-, 6- or 8-wire configurations. Ensures correct wiring every time, as well as ultra fast installations. 
- **UL Listed commercial outlet centers.** File E317375 Multioutlet assemblies rated to 20A maximum can be provided with listed cord and plug assemblies. These assemblies are optimal for mounting to semi-permanent structures such as shelving and rack displays found in many lab applications. 
- **UL and cUL Listed component raceways.** File E4376 Guide RJBT, Fittings: File E41751 Guide RJPR. Meets Article 386 of NEC and meets Section 12-600 of CEC.
- **UL and cUL Listed multioutlet assemblies.** File E15191 Guide PVGT, Fittings: File E41751 Guide RJPR. Meets Article 380 of NEC and meets Section 12-3032 of CEC.
- **Datacom connectivity options.** Accepts industry standard and proprietary devices from a wide range of manufacturers to provide a seamless and aesthetically pleasing interface for voice, data, audio, and video applications at the point of use.

Prewired Raceway is prewired, labeled and packed to job site specifications before shipping to the job site.

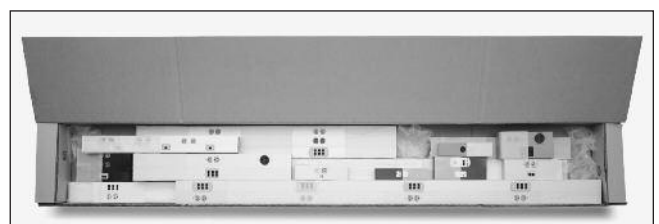

ALA3800 Series Raceway Specifications

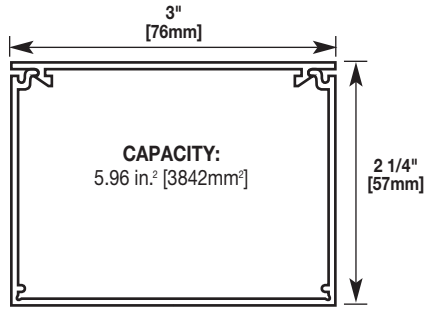

ALA3800B-10

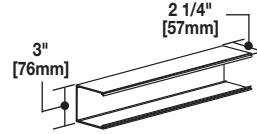



Base – Satin Anodized finish. Nominal wall thickness of 0.078" [1.99mm]. Packed four 10' [3.00m] lengths per carton.

ALAC-5

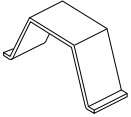
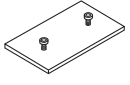

Cover – Satin Anodized finish. Nominal wall thickness of 0.078" [1.99mm]. Packed eight 5' [1.50m] lengths per carton.

ALA3800 Series Raceway Fittings

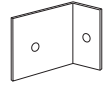
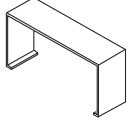
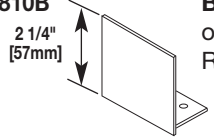
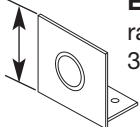
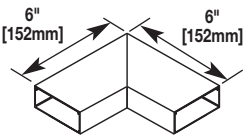
Catalog No./Item	Description/Specifications
ALAWC 	Wire Clip – Holds conductors in place in long runs of ALA3800 Series Raceway. Snaps into grooves on base.
ALA01 	Slide Coupling – Connects adjoining sections of ALA3800 Series Raceway base.
ALA09 	Grounding Adapter – Connects equipment grounding conductor to ALA3800 Series Raceway.
ALA17A 	Internal Corner Coupling – Forms an internal 90° turn in a run of ALA3800 Series Raceway.
ALA3806 	Cover Clip – Covers seams where sections of ALAC-5 Cover come together.
ALA3810B  2 1/4" [57mm]	Blank End Cap – Closes off open ends of ALA3800 Series Raceway.
ALA3810B1  2 1/4" [57mm]	Entrance End Cap – For feeding raceway, has concentric 1/2" and 3/4" knockouts.
ALA3811  6" [152mm]	90° Flat Mitered Elbow with Coupling – Makes 90° turns in runs of ALA3800 Series Raceway. Includes two (2) ALA01 Couplings.

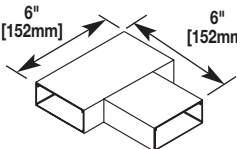
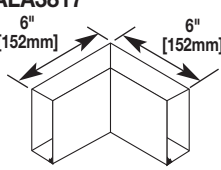
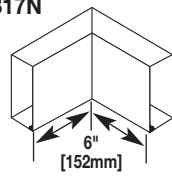
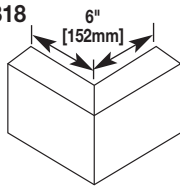
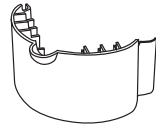
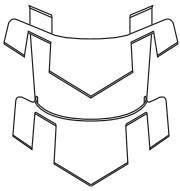
Catalog No./Item	Description/Specifications
ALA3815  6" [152mm]	Flat Tee with Coupling – Makes branch connections of two runs of ALA3800 Series Raceway. Includes three (3) ALA01 Couplings.
ALA3817  6" [152mm]	Internal Mitered Elbow with Coupling – Makes 90° internal turns in runs of ALA3800 Series Raceway. Includes two (2) ALA01 Couplings.
ALA3817N  6" [152mm]	Inverted Internal Elbow – Connects vertical runs with horizontal runs of ALA3800 Series Raceway with its cover facing up. Includes two ALA01 Couplings.
ALA3818  6" [152mm]	External Mitered Elbow with Coupling – Makes 90° external turns in runs of ALA3800 Series Raceway. Includes two (2) ALA01 Couplings.
ALA11RI 	2" [51mm] Bend Radius Control Insert for Flat Elbow – Installs in ALA3811 Flat Elbow. For new and retrofit applications whether the cable installation is lay-in or pull-through.
ALA17/18RI 	2" [51mm] Bend Radius Insert for Internal and External Elbow – Inserts into ALA3817, ALA3817N, and ALA3818 fittings. For new and retrofit applications whether the cable installation is lay-in or pull-through.

ALA3800 Component Raceway Device Plates

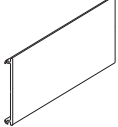
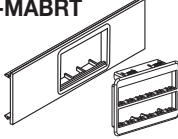
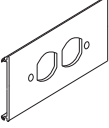
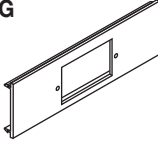
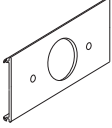
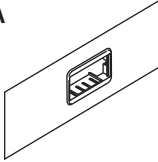
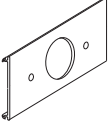
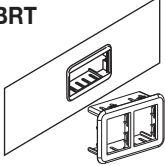
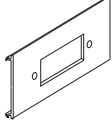
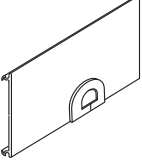
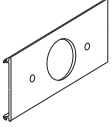
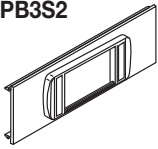
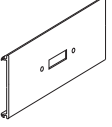
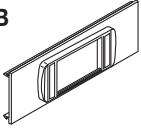
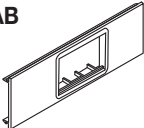
Catalog No./Item	Description/Specifications	Catalog No./Item	Description/Specifications
ALA-BL	 Blank Cover Plate – Covers a 12" [305mm] section of raceway.	ALA-MABRT	 Ortronics® Cover Plate – Accepts six Ortronics TracJack® or three Series II communication inserts. Both bezels included
ALA-DR	 Duplex Receptacle Cover Plate – Mounts standard duplex devices to the cover. Accepts 106 Frame.	ALA-SG	 Cover Plate with 1 3/4" x 2 3/4" [44mm x 70mm] Holecut – Accepts Activate connectivity inserts with a single-gang faceplate or angled single-gang faceplate (not included).
ALA-E	 Single Receptacle Cover Plate – 1.40" [36mm] diameter. For straight blade and locking single receptacles.	ALA-2A	 Activate 2A Cover Plate – Accepts a single 2A Activate insert. Includes bezel.
ALA-F	 Single Receptacle Cover Plate – 1.59" [40mm] diameter. For straight blade and locking single receptacles.	ALA-ABRT	 Ortronics® Cover Plate – Accepts two Ortronics® TracJack or one Series II communication insert. Both bezels included.
ALA-G	 GFCI/Surge/Decorator Cover Plate – Accepts GFCI or Pass & Seymour® Surge protection receptacles.	ALA-Z	 3/4" [19.1mm] Grommet/ Mousehole Cover Plate – Facilitates the exit of voice or communication cabling. Grommet included.
ALA-J	 Single Receptacle Cover Plate – 2.13" [54mm] diameter. For straight blade or locking single receptacles.	ALA-LPB3S2	 Ortronics® Low Profile Bezel Cover Plate – Accepts three (3) Ortronics® Series II communication inserts. Low Profile Bezel included.
ALA-N	 Toggle Switch Cover Plate – Accepts toggle switches.		
ALA-LPB	 Activate LPB Cover Plate – Accepts Activate connectivity inserts. Includes cover and Activate low profile bezel with station label openings. (6A size opening)		
ALA-MAB	 Activate MAB Cover Plate – Accepts Activate connectivity inserts. Provides a flush installation. Includes bezel.		

NOTE: ALL ALA3800 Component Raceway Device Plates shown on this page are 12" [305mm] in length.

A full range of fittings are available for fast and easy installations.

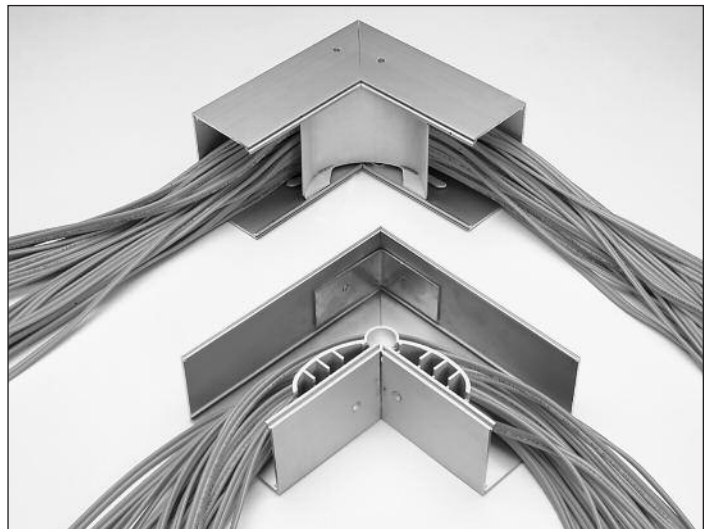
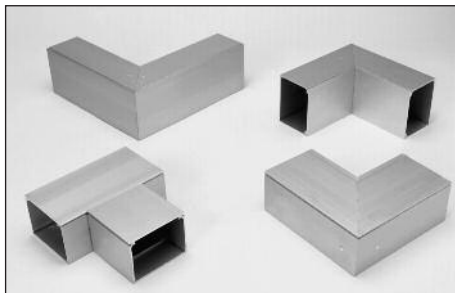

2" [51mm] Bend Radius Compliant Inserts installed in fittings.

ALA3800 Series Raceway Features

FEATURES	STANDARD	OPTIONS
Communication Devices	Ortronics & Activate Connectivity System Devices	Other manufacturers
Electrical Devices	Pass & Seymour	Other manufacturers
Cover Length	12" [305mm] or 18" [457mm]	24" [610mm], 36" [914mm], custom or continuous
Body Length	Longest = 10' [3.05m], shortest = 1' [305mm]	
Installation	Surface mounted	Flush mounted (recessed)
Finish	Architectural Class II Clear Anodized	Custom colors available, consult factory.*
Fittings	Mitered	Butt joints or custom
Wire Type	THHN Stranded	Options per specification
Wiring Splices	Insulation displacement connectors	Continuous wiring or twist-on wire connector
Grounding Conductors	Wire gauge per National Electrical	Oversized and/or separate grounding wires Code (NEC) and shared grounding wires
Device Identification	Gray self-adhesive polyester label with black letters	Engraved covers, self-adhesive engraved nameplate, screw mounted engraved nameplate
Neutrals	Shared neutral	Oversized and/or separate neutral wires
Pigtails	12" [305mm] feeds and receptacle leads	Per specification
Conduit Feeds	Raceway drilled at job site with hole saw	Entrance end cap
Device Mounting	Mounted to cover with 2 counter-sunk #6-32 screws	Device mounting brackets
Record Drawings	3 sets and 2 copies of marked-up blueprints	Per job requirements
Submittal Services	Detailed Submittal	Express Submittal or Submittal Free

* Paint chip required for custom colors.

ALA3800 Series Raceway Ordering Process for Prewired Applications

- Detailed Submittal** The detailed submittal shows exactly how each raceway run will be built (lengths, number and type of receptacles, wiring schematics, circuiting information, etc.). The contractor and/or distributor must review and correct any information not clearly indicated on the drawings or specs, approve and return before production can be scheduled.
- Submittal Free** The Prewired Express Building Plan Checklist is filled out by the contractor or distributor and sent along with plans, casework, and specs. No submittal is required and the project is scheduled for production upon receipt of all information.

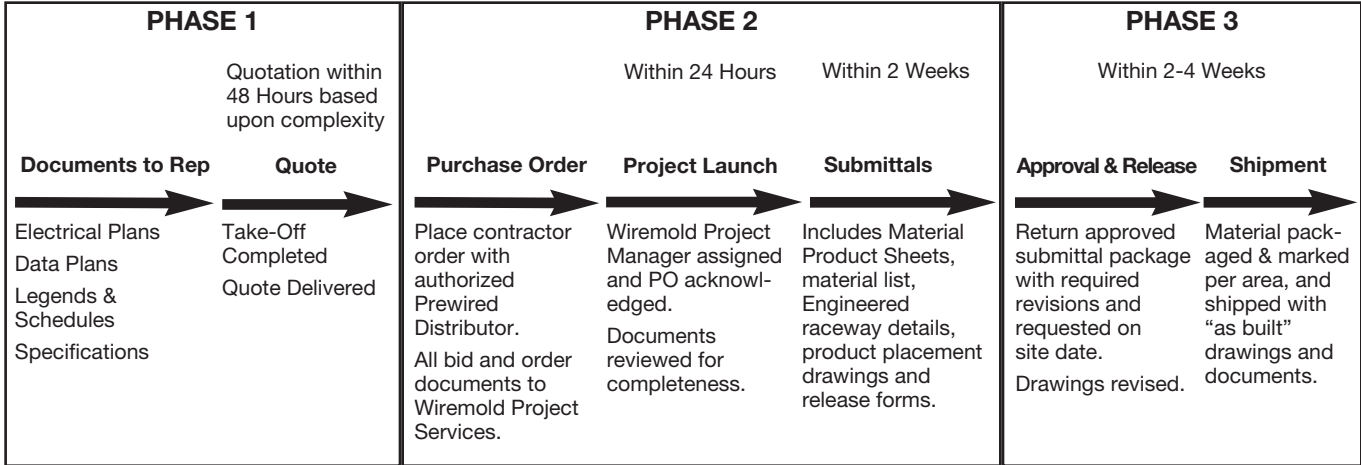

Prewired Raceway gets installers off the job in 1/3 less time than conventional raceway installations.

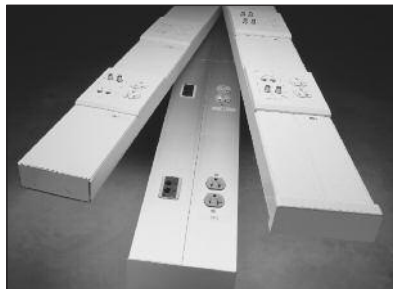

Wiremold Prewired Raceway is available in a wide range of capacity and configuration options.

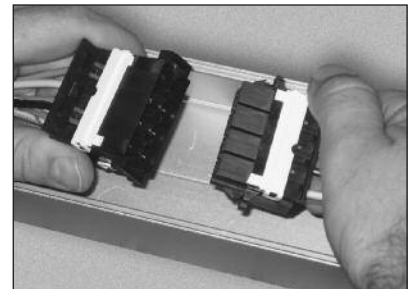

Prewired Connectors provide contractors with peace-of-mind. Connectors are factory wired and tested so errors, backtracking and troubleshooting are virtually eliminated.

ALA3800 Series Raceway Device Openings

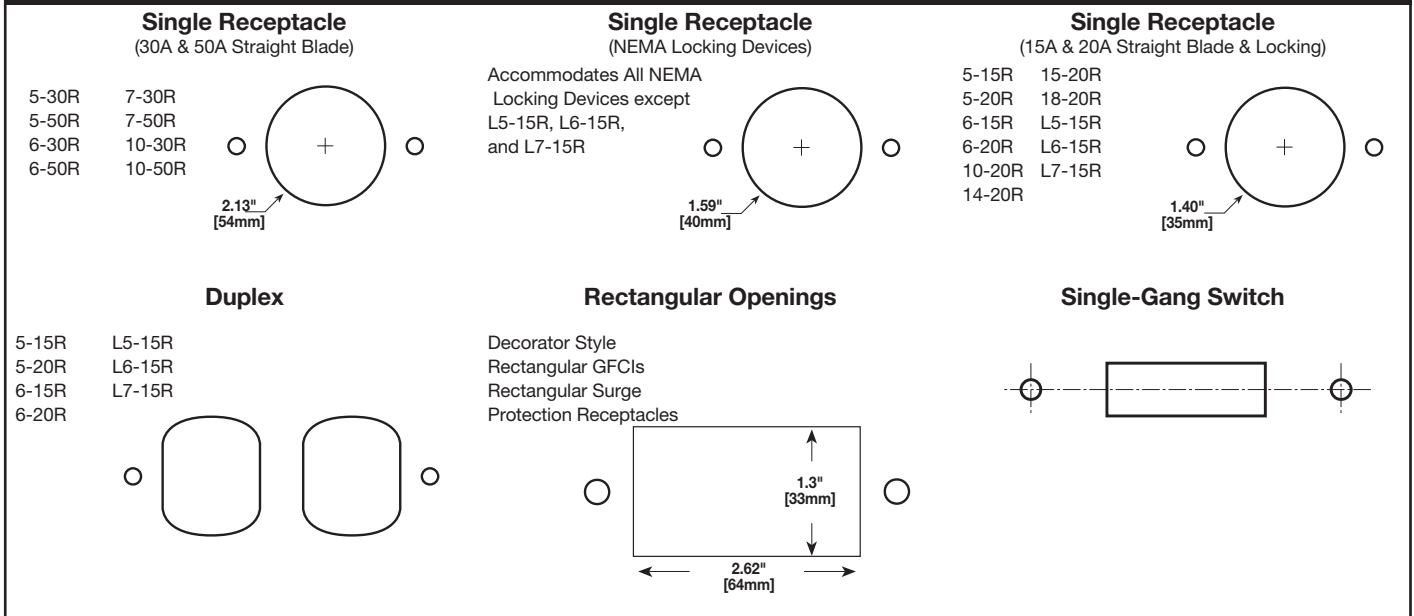

NOTE: Custom openings are also available – consult factory for more information.

ALA3800 Series Raceway Device Compatibility for Prewired Applications

NEMA Locking Compatibility

All of the following NEMA locking devices will fit.

L5-15R	L6-15R	L7-15R	L8-20R	L10-20R	L12-20R	L14-20R	L16-20R	L18-20R	L20-20R	L22-20R
L5-20R	L6-20R	L7-20R	L8-30R	L10-30R	L12-30R	L14-30R	L16-30R	L18-30R	L20-30R	L22-30R
L5-30R	L6-30R	L7-30R	L9-20R	L11-20R	L13-20R	L15-20R	L17-20R	L19-20R	L21-20R	L23-20R
			L9-30R	L11-30R	L13-30R	L15-30R	L17-30R	L19-30R	L21-30R	L23-30R

NEMA Straight Blade Compatibility**

5-15R	5-20R	5-30R	5-50R	6-20R	6-30R	6-50R	7-30R	7-50R	10-20R	10-30R	10-50R	14-20R	14-30R
Y	Y	Y	Y	Y	Y	Y	Y	Y	Y	Y	Y	Y	Y
14-50R	14-60R	15-20R	15-30R	15-50R	15-60R	18-20R	18-60R	GFCI	SURGE				
Y	1	Y	Y	Y	Y	Y	Y	Y	Y				

Y= will fit N= will not fit 1= Requires adapter box

* Based on Pass & Seymour device specifications.

Device and Raceway Labeling Detail for Prewired Applications

- Device labeling is available in the following materials:
 - Gray self-adhesive polyester label with black lettering (standard).
 - Other color self-adhesive polyester labels.
 - Engraving of covers with black lettering.
 - Engraved phenolic nameplates with adhesive backing.
 - Screw mounted engraved phenolic name plates.
- The back of the raceway is labeled with the raceway number and the room or area number(s).

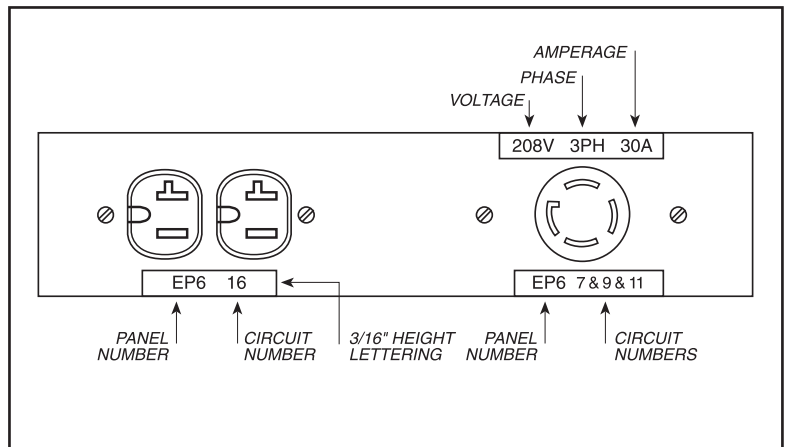

ALA3800 Series Raceway Wire Fill Capacity Charts

ALA3800 Raceway Wire Fill Capacities for Data/Communication

CABLE/WIRE TYPE		O.D.		AL4400	AL4520**	ALA4750	ALA3800	ALA4800**	AL7450	
		Inches	[mm]	40%	40%	40%	40%	40%	TOP 40%	BOTTOM 40%
UNSHIELDED TWISTED PAIR	4-pair, 24 AWG Cat. 3	0.190	[4.8]	66	84	69	86	86	71	66
	4-pair, 24 AWG Cat. 5e	0.210	[5.3]	55	69	57	70	70	58	55
	4-pair, 24 AWG Cat. 6	0.250	[6.4]	38	48	40	50	50	41	38
	4-pair, 24 AWG Cat. 6a*	0.354	[9.0]	19	24	20	25	25	20	19
	25-pair, 24 AWG	0.360	[9.1]	19	23	19	24	24	20	19
COAXIAL	RG6/U	0.270	[6.9]	33	41	34	43	43	35	33
FIBER OPTIC	ZipCord	0.118 x 0.236	[3 x 6]	68	85	70	88	88	72	68
	Round 4 Strand Fiber	0.187	[4.7]	69	87	71	89	89	73	69
	Round 6 Strand Fiber	0.256	[6.5]	37	46	38	47	47	39	37

* Category 6 augmented (6a) cable for 10 gigabit ethernet – max allowed cable diameter per addenda No. 11 ANSI TIA/EIA 568-B.2.

** Each compartment.

ALA3800 Raceway Wire Fill Capacities for Power (40% Fill Factor)

WIRE SIZE THHN (STRANDED)		ALA3800	AL4400*	AL4520*	AL4750	AL7450		ALA4800*
						Single	Dual*	
POWER WIRING WITHOUT DEVICES	8 AWG	41	50	54	35	53	49	41
	10 AWG	56	87	110	61	108	101	56
	12 AWG	98	139	172	97	170	159	98
POWER WIRING WITH GFCI DEVICES (2.04 sq. in.)	8 AWG	30	28	32	13	31	27	30
	10 AWG	42	49	65	22	64	57	42
	12 AWG	73	77	102	35	100	89	73

* Each compartment

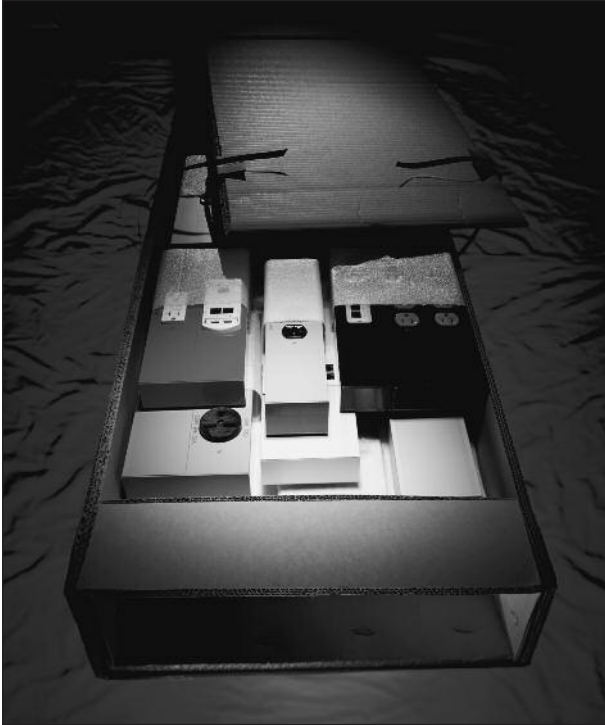

Wiremold Prewired Raceway reduces installation time, gets installers off the job faster, and eliminates the need for field cutting.

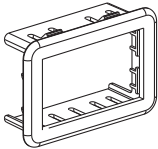
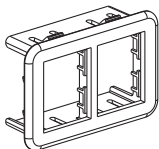
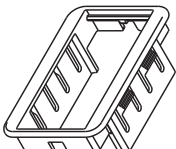
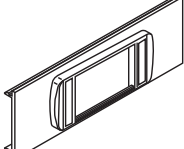
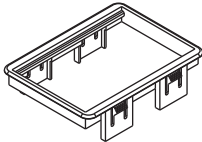
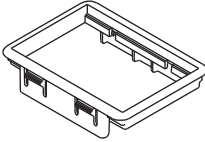
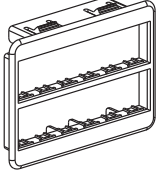

Contact your local Wiremold Representative or the factory for more information on prewired raceway and assistance in planning your next prewired installation. Our Prewired Raceway Team is ready to help.

Communication Adapters

Ortronics		Pass & Seymour/Ortronics		
<p>ABS2</p>  <p>Accepts One Series II Module</p>	<p>AB2TJ</p>  <p>Accepts Two TracJack Modules</p>	<p>CM-2AB</p>  <p>Accepts One Activate 2A Module</p>	<p>Low Profile Adapter (LPB)</p>  <p>LPB – Accepts 3 Pass & Seymour Activate Inserts LPB3S2 – Accepts 3 Ortronics Series II Inserts</p>	
		<p>MAB</p> 	<p>MAB3S2</p> 	<p>MAB6TJ</p> 

NOTE: Custom openings are also available – consult factory for more information.

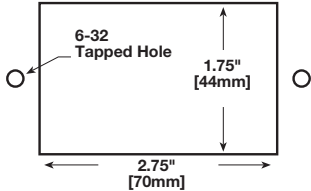
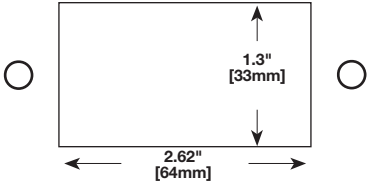
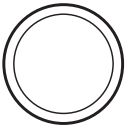
ALA3800 Series Raceway Communication Openings

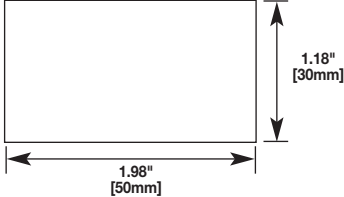
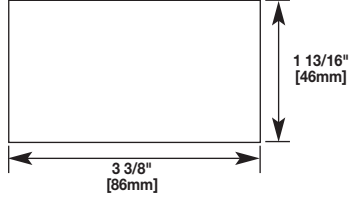
Wallplate Openings	Rectangular Openings	Grommet Openings
 <p>6-32 Tapped Hole</p> <p>1.75" [44mm]</p> <p>2.75" [70mm]</p>	 <p>1.3" [33mm]</p> <p>2.62" [64mm]</p>	<p>1/4" [6.4mm] Inner Diameter 1/2" [12.7mm] Inner Diameter 3/4" [19.1mm] Inner Diameter Standard 1" [25mm] Inner Diameter</p> 
<p>Duplex for Data</p> 	<p>AB Bezel Openings</p>  <p>1.18" [30mm]</p> <p>1.98" [50mm]</p>	<p>Low or High Profile Bezel Openings</p>  <p>1 13/16" [46mm]</p> <p>3 3/8" [86mm]</p>

NOTE: Custom openings are also available – consult factory for more information.

DATACOM CONNECTIVITY OPTIONS

Now you have a wide range of options for providing datacom connectivity into Wiremold/Legrand Pathways. They are:

- **Ortronics® TracJack® and Series II Modular Connectivity Solutions**
- **Pass & Seymour Activate™ Modular Inserts**
- **Open System Communication Modules**

Ortronics® Connectivity

TracJack® Individual Jack System

- Front-loading, snap-in design supports future moves adds and changes
- Inserts for voice, data, audio, and video
- Available Category 3, 5e, 6, USOC 6-position, and other media
- Flat or angled 45° exit configurations
- Choice of 13 colors and color matched to Wiremold Systems
- Universal T568A/B wiring format

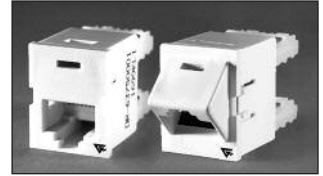

Series II Front-Loading, Module System

- Module design features easy snap-in front-loading design
- Linear 110 punch down format for easy termination
- Inserts for voice, data, audio, and video
- Available Category 3, 5e, 6, USOC 6-position, and other media
- Available in flat or angled 45° exit configurations
- Color matched to Wiremold Systems



For detailed product selection refer to the **Ortronics Catalog** or visit www.ortronics.com.

Pass & Seymour Legrand Network Wiring

Activate™ Series Front-Loading Inserts

- Modular inserts for voice, data, audio and video applications
- Front-load, snap-in design
- Color and texture matched to Wiremold Systems
- Available Category 3, 5e, 6, as well as 6-position USOC
- Universal T568A/B wiring format

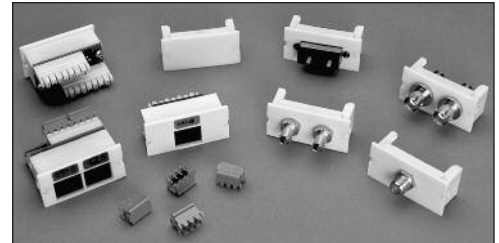

For detailed product selection refer to the **Pass & Seymour Network Wiring Catalog** or visit www.passandseymour.com.

Open Connectivity Solutions

Wiremold Open System Communications Modules

- Accommodate a wide range of manufacturers' communications outlets including keystone jacks, as well as proprietary solutions from Avaya (Systimax) and NORDX
- Modules insert into a wide range of Wiremold Systems
- Pre-punched faceplates accept common communication devices

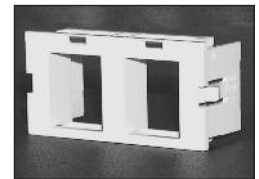

NOTE: For more information on integrating connectivity into Wiremold Cable Management Systems contact the Wiremold Applications Engineering Team or your local Wiremold Sales Representative.



Wiremold

WIREMOLD

U.S. and International:

60 Woodlawn Street • West Hartford, CT 06110
1-800-621-0049 • FAX 860-232-2062 • Outside U.S. 860-233-6251

Canada:

570 Applewood Crescent • Vaughan, Ontario L4K 4B4
1-800-723-5175 • FAX 905-738-9721

ED800R8 - Updated January 2010 - For latest specs visit www.legrand.us/wiremold

