

6A Communication Opening

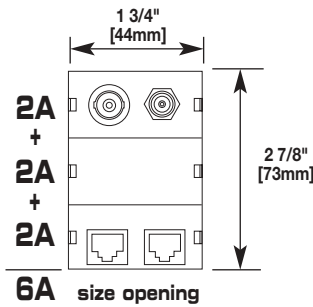
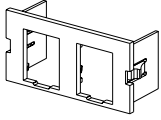
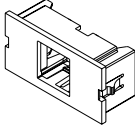
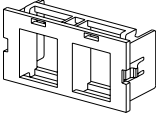
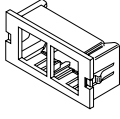
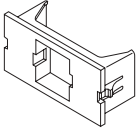
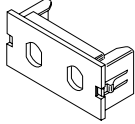
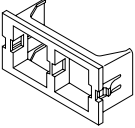
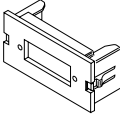
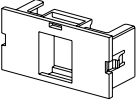
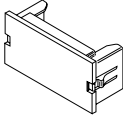
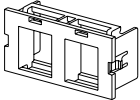

Open System Modules

Catalog No./Item	Description/Specifications	Catalog No./Item	Description/Specifications
CM2-U2TJ 	2A, Dual Flushmount Ortronics® TracJack® Module – For mounting two TracJack devices.	CM2-U1NOR 	2A, Single Flushmount NORDX/ CDT Unloaded Module – For use with MDVOFlex Jacks and Fiber Modules.
CM2-U2AMP 	2A, Single Unloaded AMP NETCONNECT Module – For mounting two AMP NETCONNECT SL Series devices.	CM2-U2NOR 	2A, Dual Flushmount NORDX/ CDT Unloaded Module – For use with MDVOFlex Jacks and Fiber Modules.
CM2-U1ATT 	2A, Single Unloaded Avaya/Lucent Module – For use with M-Series Jacks and LC Adapters.	CM2-U2ST 	2A, Dual Unloaded ST Adapter Module
CM2-U2ATT 	2A, Dual Unloaded Avaya/Lucent Module – For use with M-Series Jacks and LC Adapters.	CM2-U2SC 	2A, Unloaded Duplex SC Adapter Module
CM2-U1KEYA 	2A, Single Flushmount Unloaded Keystone Module – For mounting jacks with a latching area of 0.57" x 0.76" [14.5mm x 19.3mm].	CM2-BL 	Blank Insert
CM2-U2KEYA 	2A, Dual Flushmount Unloaded Keystone Module – For mounting jacks with a latching area of 0.57" x 0.76" [14.5mm x 19.3mm].		

NOTE: Standard color is Ivory, for other colors add suffix: "-WH" for White, "-GY" for Light Gray (matches aluminum and nonmetallic raceways), "-BK" for Black, and "-G" for Gray (matches Gray steel raceways).

Open System Communication Connectivity Solutions

Mounting industry standard communication devices in Wiremold Wire and Cable Management Systems has never been easier. The Wiremold Communication Module Series supports open system architecture by providing a variety of unloaded modules to accept devices from other manufacturers. These open system modules provide a flexible and aesthetically pleasing way to connect communication cabling at the point-of-use.



Shown: Dual and Single Unloaded Keystone Jack Modules.

Features & Benefits

- **Open system capabilities.** Unloaded modules are available to accept a wide range of industry standard keystone jacks, SC & ST fiber optic adapters, as well as, select proprietary solutions from AMP NET CONNECT, Avaya/Lucent and NORDX.
- **Wire management compatible.** Modules snap securely into Wiremold communication ready device brackets featuring 2A & 6A openings for an aesthetically pleasing look.
- **Installation and configuration ease.** Modules feature a front load snap-in design for ease of installation and allowing outlet configuration changes to be made quickly.
-  Listed.



Communication modules provide a seamless point-of-use interface in Wiremold Wire and Cable Management Systems.
Shown: WallSource Multiservice Box, FloorSource Raised Floor Box and 5400 Series Raceway.