

Bring technology connections to the point-of-use

Work Surface Table Boxes bring technology closer to the user's work area. The routing of power, A/V connections and communications is virtually transparent and increasingly more accessible. Our wide range of Work Surface Table Box solutions offer flexibility to meet the connectivity and power configurations required to run business smoothly while enhancing the overall room appearance. From desks and lab benches to conference rooms or executive board rooms, Work Surface Table Boxes make technology easily accessible to the user.



deQuorum Work Surface Table Boxes are ideal for executive boardrooms.



FEATURES & BENEFITS

- **Range of solutions.** Wiremold Table Boxes allow you to access services on, above or below the work surface with cord-ended or field-wired options. Standard off-the-shelf, field configurable or custom configurations are available to meet any work area need.
- **Variety of applications.** Office workstations, conference rooms, medical laboratories, even home offices can increase productivity by bringing access to connections up to the work surface.
- **Aesthetics.** Elegant yet functional access to services includes cover style and color options to meet room décor.
- **Ease of installation.** From placing a cord-ended unit in an existing opening, or using the supplied template to create the cut out, Work Surface Table Boxes are made easy to install so you can get back to business.
- **Safety.** Wiremold Work Surface Table Boxes meet U.S. and Canadian safety standards.



From left to right: Evolution™ Series Work Surface Table Boxes, deQuorum™ Flip-Up Work Surface Table Box, deQuorum Work Surface Table Box

Table Box Quick Selection Guide

TABLE BOX MODEL	SVC. LOCATION @ TABLE	CORD LENGTH	FIELD-WIRED WHIP LENGTH	COVER COLOR/MATERIAL	ELECTRICAL OUTLETS	DATA OPENINGS	A/V OPENINGS
 Evolution 6" Boxes	Recessed 6" Diameter	12' [3.66m]	6' [1.83m]	Nickel, Bronze, Gray, Black, Brass Powder Coat	(2) 15A Duplex	(2) Ortronics® Cat 6 RJ45 Jacks	(5) Legrand AVIP Plates or Extron® Electronics MAAP modules*
	Recessed 8" Diameter	12' [3.66m]	6' [1.83m]	Nickel, Bronze, Gray, Black, Brass Powder Coat	(2) 15A Duplex	(6) Ortronics® Cat 6 RJ45 Jacks	(10) Legrand AVIP Plates or Extron® Electronics MAAP modules*
 deQuorum Recessed Boxes	Recessed	12' [3.66m]	6' [1.83m]	Gray, Black	(2) 20A Duplex Gasketed	Adapters for Ortronics® Series II, TracJack or Wiremold Open System	Cable Cord Keeper or Legrand AVIP Plates or Extron® Electronics MAAP modules – (6) single or (3) double*
 deQuorum Flip Up Boxes	Above	12' [3.66m]	N/A	Black, Stainless	(1) 15A or 20A Duplex	Adapters for Ortronics® Series II, TracJack or Wiremold Open System	Convenience Power Hospitality

deQuorum™ Recessed Table Boxes

deQuorum™ Recessed Work Surface Table Boxes provide flexibility in décor, data and AV connectivity options, and installation to meet specific functional and aesthetic needs. deQuorum™ Recessed Work Surface Table Boxes feature covers that can be closed during use to make the box unobtrusive.



deQuorum Work Surface Table Boxes provide recessed access to power and communications services with multiple cover options.

CODE REFERENCE

cULus Listed Relocatable Power Tap:
File E66421 Guide XBY5
cULus Listed Multioutlet Assembly:
File E15191 Guide PVGT
Listed to US & Canadian Safety Standards
Meets Article 380 of NEC.

deQUORUM WORK SURFACE TABLE BOX COLOR OPTIONS

deQuorum Work Surface Box Covers are available in the following finishes: Black and Gray

deQuorum Recessed Table Box Part Number Configurator

deQuorum Recessed Work Surface Portals



deQuorum Series:
KC = Cord Ended
KF = Field Wired



Cover Style:
Flush = 1
Contoured = 4



Cover Color:
Black = 0
Gray = 5

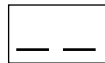

Communications:
Ortronics = RT
Wiremold = CM
Open System



Top Style:
Recessed = 2
Blank = 8

For information regarding communication inserts, go to:
www.legrand.us/wiremold

NOTE: Part number configurator can be used both to identify stock product configurations and also to request custom configurations from factory.

deQuorum Recessed Table Box Cover Options

FLUSH COVERS – Available finishes: Black or Gray. Shown with flange.

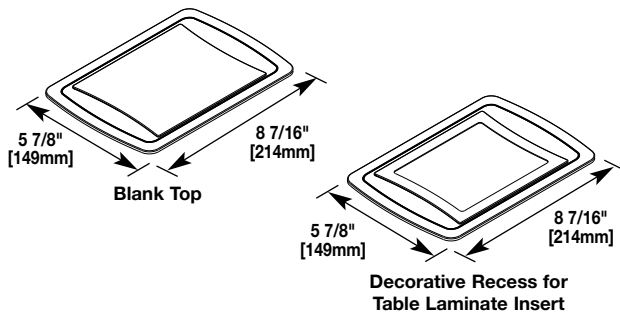

CONTOURED COVERS – Available finishes: Black or Gray. Shown with flange.

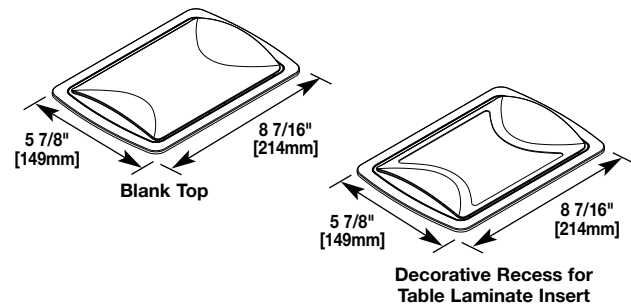

deQuorum Recessed Table Box In-Stock Configurations Ordering Information

CATALOG NUMBER	DESCRIPTION	Cord-Ended Unit
KC10CM2	Cord-ended with black, flush cover with decorative recess. Unit comes with two 20A gasketed prewired receptacles with a 12' [3.65m] 14/3 SJT black cord. Includes adapters for Wiremold CM Series Open System communications outlets. Communication modules sold separately.	
KC10RT8	Cord-ended with black, flush cover. Unit comes with two 20A gasketed prewired receptacles with a 12' [3.65m] 14/3 SJT black cord. Includes adapters for Ortronics® Series II and TracJack inserts. Communication modules sold separately.	
KC15RT8	Cord-ended with gray, flush cover. Unit comes with two 20A gasketed prewired receptacles with a 12' [3.65m] 14/3 SJT black cord. Includes adapters for Ortronics® Series II and TracJack inserts. Communication modules sold separately.	
KF10CM8	Field-wired with black, flush cover. Unit comes with two 20A gasketed prewired receptacles with a 3/8" [9.5mm] diameter 6' [1.83m] flexible whip. Includes adapters for Wiremold CM Series Open System communications outlets. Communication modules sold separately.	
KF15RT2	Field-wired with gray, flush cover with decorative recess. Unit comes with two 20A gasketed prewired receptacles with a 3/8" [9.5mm] diameter 6' [1.83m] flexible whip. Includes adapters for Ortronics® Series II and TracJack inserts. Communication modules sold separately.	

deQuorum Recessed Table Box Communication Plates Ordering Information

PART NO.	DESCRIPTION	PART NO.	DESCRIPTION
KA102RT	<p>Replacement Ortronics Communications Plate – Installed adapters will accommodate either Ortronics® Series II front-loading module system or the TracJack individual jack system. Includes black plate, three (3) Series II and three (3) TracJack adapters.</p>	KA302	<p>Cable Cord Keeper Plate – Holds cables captive for easy access when active jacks are not needed. Pull the cable out for use. Keeper bars provide seven adjustable openings for cables ranging from .150" to .350" [3.8mm to 8.9mm] in diameter.</p>
KA104CM	<p>Replacement Wiremold Open System Communications Plate – Installed adapters accept Wiremold CM Series modules to accommodate a wide range of communications outlets. Includes black plate and three (3) Wiremold Open System CM2 adapters.</p>	KA305	<p>Legrand AVIP Adapter Plate – Accepts six (6) single size Legrand AVIP Plates or Extron® MAAP or three (3) double size MAAP modules, or any combination. Includes necessary hardware.</p>
KA700	<p>Replacement 20A Gasketed Receptacle Plate – Plate has factory-installed receptacles ready to connect with installed unit. Can be used for field-installed or cord-ended units.</p>	KA305-AAP 4 3/4"	<p>Extron® AAP Adapter Plate – Accepts three (3) AAP plates. Includes necessary hardware.</p>
		KA301	<p>Single-Gang Opening Plate – Use this plate to install any communication and/or multimedia connectivity that requires a single-gang wallplate. Includes necessary mounting hardware.</p>

deQuorum™ Flip-Up Table Boxes

deQuorum™ Flip-Up Work Surface Table Boxes provide flexibility in décor, communication connectivity options, and installation to meet specific functional and aesthetic needs. Flip-Up Table Boxes bring the modules above the work surface when in use for easy access.

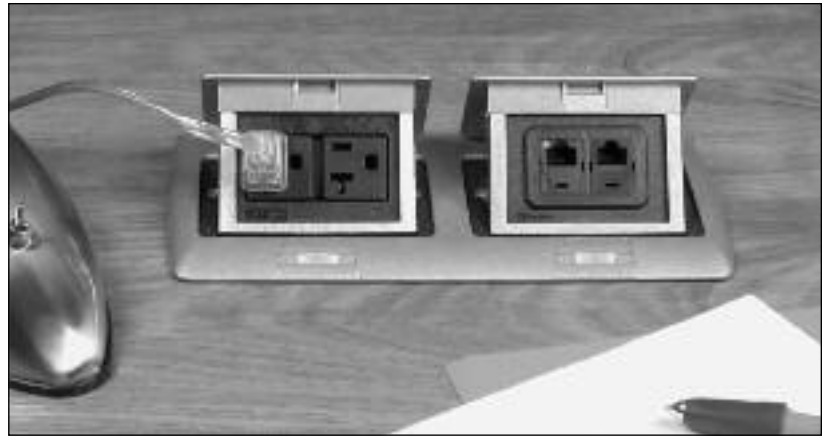

deQuorum Flip-Up Work Surface Table Boxes provide desktop access to power and communications services.

CODE REFERENCE

cULus Listed Relocatable Power Tap:
File E66421 Guide XBY5
Listed to US & Canadian Safety Standards
Meets Article 380 of NEC.

deQUORUM WORK SURFACE TABLE BOX COLOR OPTIONS

deQuorum Flip-Up Work Surface Table Box Covers are available in the following finishes: Black and Stainless.

deQuorum Flip-Up Table Box Part Number Configurator

deQuorum Flip-Up Work Surface Table Boxes

K P

— — — —

— —

— —

deQuorum Series:

Unit Color:

Communications:

Receptacle:

KP = Flip Up Portal

Black = 9999
Stainless = 2345

Ortronics = RT
Wiremold
Open System = CM

20Amp = Blank
15Amp = 15

For information regarding communication inserts, go to:
www.legrand.us/wiremold

deQuorum Flip-Up Table Box Ordering Information

PART NO.	DESCRIPTION	PART NO.	DESCRIPTION
KP9999 KP9999-15	Single Flip-Up Unit – Black cover. KP9999 includes one 20A black gasketed duplex receptacle. KP9999-15 includes one 15A black gasketed duplex receptacle. Both units come with a 12' [3.66m] cord.	KP2345 KP2345-15	Single Flip-Up Unit – Stainless finish cover. KP2345 includes one 20A black gasketed duplex receptacle. KP2345-15 includes one 15A gasketed duplex receptacle. Both units come with a 12' [3.66m] cord.
KP9999RT KP9999RT-15	Dual Flip-Up Unit – Black cover. KP9999RT includes one 20A black gasketed duplex receptacle and one (1) Ortronics® Series II and one (1) Tracjack adapter to accommodate either Series II front-loading modules or TracJack individual jack. KP9999RT-15 includes one 15A black gasketed duplex receptacle. Both units come with a 12' [3.66m] cord.	KP2345RT KP2345RT-15	Dual Flip-Up Unit – Stainless finish cover. KP2345RT includes one 20A black gasketed duplex receptacle and one 2A adapter to accommodate either Ortronics® Series II front-loading modules or TracJack individual jacks. KP2345RT-15 includes one 15A black gasketed duplex receptacle. Both units come with a 12' [3.66m] cord.
KP9999CM KP9999CM-15	Dual Flip-Up Unit – Black cover. Wiremold CM Series Open System 2A modules for a wide range of communications outlets. KP9999CM-15 is the same as KP9999CM except with a 15A black gasketed duplex receptacle. Both units come with a 12' [3.66m] cord.	KP2345CM KP2345CM-15	Dual Flip-Up Unit – Stainless finish cover. Wiremold CM Series Open System Communication 2A modules for a wide range of communications outlets. KP2345CM-15 includes one 15A black gasketed duplex receptacle. Both units come with a 12' [3.66m] cord.

Evolution™ Series Table Boxes

Evolution™ Series Work Surface Table Boxes are designed after our successful Evolution Poke Thru Devices. Evolution Series Work Surface Table Boxes offer extra capacity and style in a conference or board room table. They provide the depth to mount devices, especially A/V devices, below the table top and the aesthetics to match room decór. They offer seamless integration of electrical, voice, data, audio and video into workstation activations.



Evolution™ Series Work Surface Table Boxes provide recessed access to power and communication services.

CODE REFERENCE

cETLus Listed:
Furniture Power Distribution Unit
Listed to US & Canadian Safety Standards

EVOLUTION WORK SURFACE BOXES COLOR OPTIONS

Evolution Work Surface Box Covers are available in the following powder coated finishes: "BK" black, "GY" gray, "NK" nickel, "BS" brass, and "BZ" bronze.

Evolution™ Series Table Box Part Number Configurator

Work Surface Series	Wiring:	Size: (Diameter)	Cover Style:	Cover Color:
WS	Field-Wired = F	6" [152m] = 6	Surface/	Nickel = NK
	Cord-Ended = Blank	8" [203mm] = 8	Beveled = S	Bronze = BZ
			Flush = F	Gray = GY
				Black = BK
				Brass = BS

NOTE: Surface/Beveled and Flush cover styles can both be used on a variety of table surfaces and provide different aesthetic options. There are differences in the installation of each style of cover. Please refer to the installation instructions for these products for more detailed information. Evolution Work Surface Table Box are not for use in floors.



Evolution™ Series Table Box provides recessed access to power and communication services.

Evolution™ Series Table Box Field-Wired Units Ordering Information

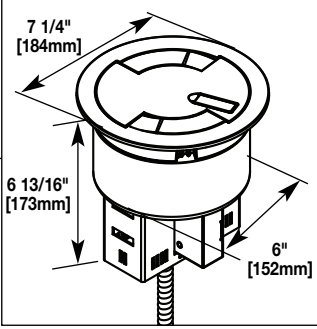
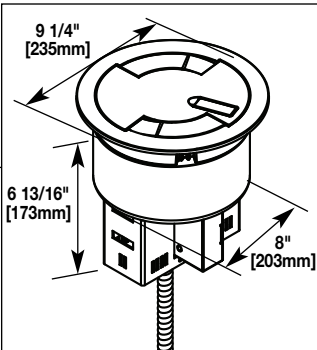
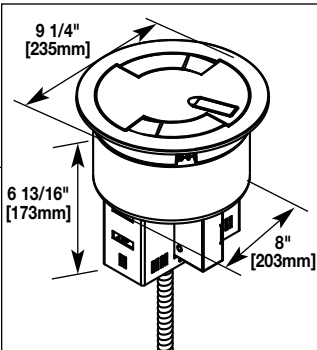
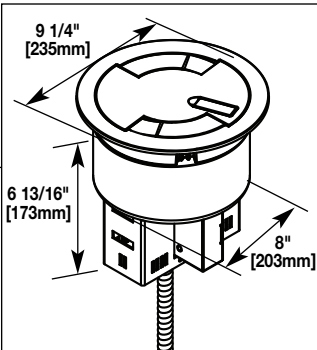
Catalog No./Item	Description/Specifications
WSF6FNK WSF6FBZ WSF6FGY WSF6FBK WSF6FBS	 <p>Field-Wired Table Box – Box has flush 7 1/4" [184mm] cover with two (2) duplex receptacles and two (2) Ortronics® Category 6 RJ45 jacks and can accept up to five (5) Extron® Electronics MAAP device plates. Units have 6' [1.8m] whip for field-wiring and are available with die-cast aluminum cover with durable powder coat finishes of nickel (WSF6FNK), bronze (WSF6FBZ), gray (WSF6FGY), black (WSF6FBK), or brass (WSF6FBS).</p>
WSF6SNK WSF6SBZ WSF6SGY WSF6SBK WSF6SBS	 <p>Field-Wired Table Box – Box has surface/beveled 7 1/4" [184mm] cover with two (2) duplex receptacles and two (2) Ortronics® Category 6 RJ45 jacks and can accept up to five (5) Extron® Electronics MAAP device plates. Units have 6' [1.8m] whip for field-wiring and are available with die-cast aluminum cover with durable powder coat finishes of nickel (WSF6SNK), bronze (WSF6SBZ), gray (WSF6SGY), black (WSF6SBK), or brass (WSF6SBS).</p>
WSF8FNK WSF8FBZ WSF8FGY WSF8FBK WSF8FBS	 <p>Field-Wired Table Box – Box has flush 9 1/4" [235mm] cover with two (2) duplex receptacles and six (6) Ortronics® Category 6 RJ45 jacks and can accept up to ten (10) Extron® Electronics MAAP device plates. Units have 6' [1.8m] whip for field-wiring and are available with die-cast aluminum cover with durable powder coat finishes of nickel (WSF8FNK), bronze (WSF8FBZ), gray (WSF8FGY), black (WSF8FBK), or brass (WSF8FBS).</p>
WSF8SNK WSF8SBZ WSF8SGY WSF8SBK WSF8SBS	 <p>Field-Wired Table Box – Box has surface/beveled 9 1/4" [235mm] cover with two (2) duplex receptacles and six (6) Ortronics® Category 6 RJ45 jacks and can accept up to ten (10) Extron® Electronics MAAP device plates. Units have 6' [1.8m] whip for field-wiring and are available with die-cast aluminum cover with durable powder coat finishes of nickel (WSF8SNK), bronze (WSF8SBZ), gray (WSF8SGY), black (WSF8SBK), or brass (WSF8SBS).</p>

Evolution™ Series Table Box Cord-Ended Units Ordering Information

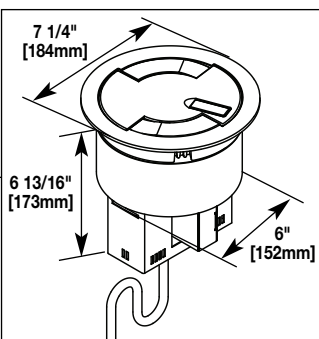
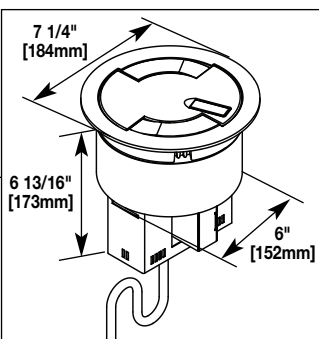
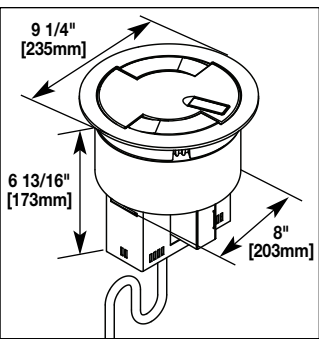
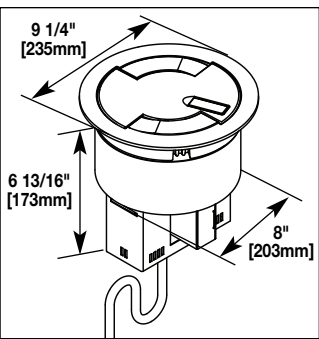
Catalog No./Item	Description/Specifications
WS6FNK WS6FBZ WS6FGY WS6FBK WS6FBS	 <p>Cord-Ended Table Box – Box has flush 7 1/4" [184mm] cover with two (2) duplex receptacles and two (2) Ortronics® Category 6 RJ45 jacks and can accept up to five (5) Extron® Electronics MAAP device plates. Units are prewired with 12' [3.7m] cord with NEMA 5-15P plug and are available with die-cast aluminum cover with durable powder coat finishes of nickel (WS6FNK), bronze (WS6FBZ), gray (WS6FGY), black (WS6FBK), or brass (WS6FBS).</p>
WS6SNK WS6SBZ WS6SGY WS6SBK WS6SBS	 <p>Cord-Ended Table Box – Box has surface/beveled 7 1/4" [184mm] cover with two (2) duplex receptacles and two (2) Ortronics® Category 6 RJ45 jacks and can accept up to five (5) Extron® Electronics MAAP device plates. Units are prewired with 12' [3.7m] cord with NEMA 5-15P plug and are available with die-cast aluminum cover with durable powder coat finishes of nickel (WS6SNK), bronze (WS6SBZ), gray (WS6SGY), black (WS6SBK), or brass (WS6SBS).</p>
WS8FNK WS8FBZ WS8FGY WS8FBK WS8FBS	 <p>Cord-Ended Table Box – Box has flush 9 1/4" [235mm] cover with two (2) duplex receptacles and six (6) Ortronics® Category 6 RJ45 jacks and can accept up to ten (10) Extron® Electronics MAAP device plates. Units are prewired with 12' [3.7m] cord with NEMA 5-15P plug and are available with die-cast aluminum cover with durable powder coat finishes of nickel (WS8FNK), bronze (WS8FBZ), gray (WS8FGY), black (WS8FBK), or brass (WS8FBS).</p>
WS8SNK WS8SBZ WS8SGY WS8SBK WS8SBS	 <p>Cord-Ended Table Box – Box has surface/beveled 9 1/4" [235mm] cover with two (2) duplex receptacles and six (6) Ortronics® Category 6 RJ45 jacks and can accept up to ten (10) Extron® Electronics MAAP device plates. Units are prewired with 12' [3.7m] cord with NEMA 5-15P plug and are available with die-cast aluminum cover with durable powder coat finishes of nickel (WS8SNK), bronze (WS8SBZ), gray (WS8SGY), black (WS8SBK), or brass (WS8SBS).</p>

NOTE: Core hole size for 6" units is 6 1/4" [159mm]. Core hole size for 8" units is 8 1/4" [210mm]. Flanges for both the 6" and 8" units extend 3/4" [19.1mm] from body of unit. Evolution Table Boxes are not for use in floors.

NOTES



Electrical Wiring Systems

60 Woodlawn Street
West Hartford, CT 06110
Phone: 1.877.BY.LEGRAND (295-3472)
www.legrand.us

570 Applewood Crescent
Vaughan, Ontario L4K 4B4
Phone: 905.738.9195
www.legrand.ca

