

sofTap™

The sofTap design features an innovative micro-movement that turns lights on and off with just a soft “tap” of the finger. Dimmers include a unique paddle to adjust light levels.

See pages 74 & 78 for switch and dimmer installation instructions.

Tru-Universal

Our Tru-Universal technology enables a dimmer to control all load types. Dimmers marked as Tru-Universal, such as the sofTap Dimmer below, automatically adapt to any load or combination of loads attached to them - Incandescent/Halogen, Magnetic Low Voltage, Electronic Low Voltage in Forward or Reverse Phase, CFL/LED bulbs, etc. They eliminate the flickering, early dropout, or “pop-on” deficiencies which can plague other non-adaptive dimmers.

The adorne Tru-Universal dimmer is the ultimate solution to dimming difficult loads. Simply pair it with any fixture and you’re done!

NAME	SPECIFICATIONS	RATING	COMPATIBLE LOADS	COMPLIANCE	FINISH OPTIONS	PART NUMBER
sofTap Switch	Single-Pole/3-Way	15A, 120 VAC, 1/2 Hp	All Loads		White Magnesium	ASTP1532W4 ASTP1532M4
sofTap Switch, Multi-Location Wireless	Wireless Master, Multi-Location Wireless Remote, Multi-Location		All Loads		White Magnesium	ASTPRF2W2 ASTPRFR2M2
sofTap Switch, Whole-House Wireless	Wireless Master, Whole-House Wireless Remote, Whole-House		All Loads		White Magnesium	ASTP155RMW1 ASTPRRW1 ASTPRRM1
sofTap Dimmer	Single-Pole/3-Way Tru-Universal 3-Wire	6W - 700W 6W - 450W	Incandescent, Halogen, Forward-Phase ELV, MLV, Fluorescent CFL, LED, Reverse-Phase ELV		White Magnesium	ADTP703TUW4 ADTP703TUM4
	Single-Pole/3-Way 2-Wire	25W - 700W	Incandescent, Halogen		White Magnesium	ADTP703HW2 ADTP703HM2
	Single-Pole/3-Way 2-Wire	25W - 1100W	Incandescent, Halogen		White Magnesium	ADTP1103HW4 ADTP1103HM4

NAME	SPECIFICATIONS	RATING	COMPATIBLE LOADS	COMPLIANCE	FINISH OPTIONS	PART NUMBER
sofTap Dimmer, Multi-Location Wireless	Wireless Master, Multi-Location Tru-Universal 3-Wire	6W - 700W 6W - 450W	Incandescent, Halogen, Forward-Phase ELV, MLV, Fluorescent CFL, LED, Reverse-Phase ELV		White Magnesium	ADTP700MMTUW2 ADTP700MMTUM2
	Wireless Master, Multi-Location 2-Wire Wireless Remote Dimmer, Multi-Location	25W - 600W	Incandescent, Halogen		White Magnesium	ADTP600MMHW2 ADTP600MMHM2
sofTap Dimmer, Whole-House Wireless	Wireless Master, Whole-House Tru-Universal 3-Wire Wireless Master, Whole-House 2-Wire Wireless Remote, Whole-House	6W - 700W 6W - 450W 60W - 600W	Incandescent, Halogen, Forward-Phase ELV, MLV, Fluorescent CFL, LED, Reverse-Phase ELV Incandescent, Halogen		White Magnesium	ADTP700RMTUW1 ADTP700RMTUM1 ADTP600RMHW1 ADTP600RMHM1 ADTPRRW1 ADTPRRM1

Push™

The Push Switch allows you to turn lights on and off with a simple push-button motion.

Pair with a Locator Status Light to add illumination to your Push switch. See page 37.

See pages 74 & 78 for switch and dimmer installation instructions.



NAME	SPECIFICATIONS	RATING	COMPATIBLE LOADS	COMPLIANCE	FINISH OPTIONS	PART NUMBER
Push Switch	Single-Pole/3-Way	15A, 120 VAC	All Loads		White Magnesium	ASPU1532W4 ASPU1532M4



SensaSwitch™ + SensaDimmer™

SensaSwitches include passive infrared (PIR) sensor technology, automatically turning lights on or off when you enter or leave a room. The design features an innovative micro-movement that allows you to also manually turn on lights with a soft touch of the finger. SensaSwitches are available in three models:

- Auto-ON/Auto-OFF: Automatically turns lights on when you enter a room and off when you leave. (Occupancy Sensor)
- Manual-ON/Auto-OFF: Allows you to turn lights on when you enter a room and automatically turns them off when you leave. (Vacancy Sensor)
- Manual-ON/Timed-OFF: Allows you to turn lights on when you enter a room and select a time for lights to turn off (options include 10, 20, 30, and 60 minutes). (Timer)



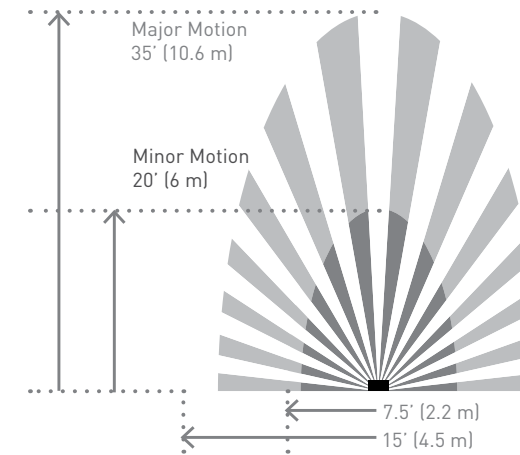













SensaSwitches are perfect for kitchens, bathrooms, garages, and pantries. The SensaDimmer turns lights on when you enter a room and off when you leave, but can be adjusted to become Manual-ON/Auto-OFF if desired. The chart to the right provides an overview of the sensor coverage area.

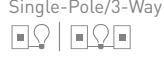

SensaSwitch™ + SensaDimmer™ Coverage Area

The Occupancy Sensor, Vacancy Sensor, and SensaDimmer each have a maximum coverage range of 180 degrees and a coverage area of 600 sq. ft. The sensor must have a clear and unobstructed view of the coverage area. Objects blocking the sensor's lens may prevent detection thereby causing the light to turn off even though someone is in the area. Windows, glass doors, and other transparent barriers will obstruct the sensor's view and prevent detection.





NAME	SPECIFICATIONS	RATING	COMPATIBLE LOADS	TIME DELAY	COMPLIANCE	FINISH OPTIONS	PART NUMBER
SensaSwitch, Auto-ON/Auto-OFF 	Single-Pole/3-Way  4-Way  Occupancy Sensor (Must be paired with another SensaSwitch or SensaDimmer)	600W, 120VAC, 60 Hz, 1/6 Hp	All Loads	5 minutes – 30 minutes		White Magnesium	ASOS32W4 ASOS32M4
SensaSwitch, Manual-ON/Auto-OFF 	Single-Pole/3-Way  4-Way  Vacancy Sensor (Must be paired with another SensaSwitch or SensaDimmer)	600W, 120VAC, 60 Hz, 1/6 Hp	All Loads	5 minutes – 30 minutes	 CA Title 24	White Magnesium	ASVS12W4 ASVS12M4
SensaSwitch, Manual-ON/Timed-OFF 	Single-Pole/3-Way  4-Way  Timer (Must be paired with another SensaSwitch or SensaDimmer)	600W, 120VAC, 60 Hz, 1/6 Hp	All Loads			White Magnesium	ASTM2W2 ASTM2M2
SensaDimmer, Auto-ON/Auto-OFF 	Single-Pole/3-Way  4-Way  Dimming Occupancy Sensor 3-Wire (Must be paired with another SensaSwitch or SensaDimmer)	25W - 700W 25W - 450W	Incandescent, Halogen  CFL/LED 	5 minutes – 30 minutes		White Magnesium	ADSM703HW2 ADSM703HM2

Wave™

The Wave switch features innovative technology combined with sleek, contemporary design. Simply wave your hand in front of the switch to turn lights on and off.

With its touch-free motion, the Wave is ideal for countertop areas in kitchens and bathrooms. It has a preset sensor distance of approximately 4". However, this can be easily adjusted to sense movement from 1" to 6" in front of switch. See pages 74 & 78 for switch installation instructions.

NAME	SPECIFICATIONS	RATING	COMPATIBLE LOADS	COMPLIANCE	FINISH OPTIONS	PART NUMBER
Wave Switch 	Single-Pole/3-Way 	15A, 120 VAC, 1/2 Hp	All Loads		White Magnesium	ASWV1532W2 ASWV1532M2

Wireless Lighting Remote Control

This unique remote allows you to control your wireless switches and dimmers from anywhere in the home as well as create lighting scenes.

The remote is easy to program and is compatible with adorne multi-location wireless lighting controls. It allows up to four lighting scenes, as well as one-touch dimming or brightening of your lights.

NAME	PART NUMBER
Wireless Lighting Remote Control 	ADMHRM4































Touch™

The Touch design features a stunning translucent face and operates just like an iPhone® - simply touch your finger on the circle to turn lights on and off, or use the arrows on the right to dim them (Touch dimmer only).

The white Touch interface is created using a unique translucent material. In multi-gang installations, we recommend pairing white Touch switches and dimmers for optimal consistency.

See pages 74 & 78 for switch and dimmer installation instructions.



NAME	SPECIFICATIONS	RATING	COMPATIBLE LOADS	COMPLIANCE	FINISH OPTIONS	PART NUMBER
Touch Switch	Single-Pole/3-Way  	15A, 120 VAC, 1/2 Hp	All Loads		White Magnesium	ASTH1532W2 ASTH1532M2
Touch Switch, Whole-House Wireless	Wireless Master, Whole-House   Wireless Remote, Whole-House  		All Loads		White Magnesium	ASTH155RMW1 ASTH155RMM1 ASTHRRW1 ASTHRRM1
Touch Dimmer, Multi-Location Wireless	Wireless Master, Multi-Location   Tru-Universal 3-Wire Wireless Remote, Multi-Location  	6W - 700W 6W - 450W	Incandescent, Halogen, Forward-Phase ELV, MLV, Fluorescent    CFL, LED, Reverse-Phase ELV   		White Magnesium	ADTH700MMTUW2 ADTH700MMTUM2 ADTHMRUW2 ADTHMRUM2
Touch Dimmer, Whole-House Wireless	Wireless Master, Whole-House   Tru-Universal 3-Wire Wireless Master, Whole-House 2-Wire Wireless Remote, Whole-House  	6W - 700W 6W - 450W 60W - 600W	Incandescent, Halogen, Forward-Phase ELV, MLV, Fluorescent    CFL, LED, Reverse-Phase ELV   Incandescent, Halogen 		White Magnesium	ADTH700RMTUW1 ADTH700RMTUM1 ADTH600RMHW1 ADTH600RMHM1 ADTHRRW1 ADTHRRM1

iPhone® is a registered trademark of Apple, Inc.

Dimensions

NAME	PART NUMBER	DIMENSIONS (H x W x D)	NAME	PART NUMBER	DIMENSIONS (H x W x D)
Paddle Switch, 2-Module	ASPD1531W4 ASPD1532M4 ASPD2032W4 ASPD2032M4 ASPD2042W4 ASPD2042M4	1.77" x 1.77" x 1.5" 1.77" x 1.77" x 1.59" 1.77" x 1.77" x 1.72"	Push Switch	ASPU1532W4 ASPU1532M4	1.77" X 1.77" x 1.82"
Paddle Dimmer	ADPD703HW4 ADPD703HM4 ADPD1103HW4 ADPD1103HM2 ADPD453LW2 ADPD453LM2	4.20" x 1.77" x 1.62" 4.20" x 2.51" x 1.62" 4.20" x 1.77" x 1.62"	SensaSwitch, Auto-ON/ Auto-OFF	ASOS32W4 ASOS32M4	2.66" x 1.77" x 1.85"
Paddle Switch, 1-Module	ASPD1531W4 ASPD1531M4	1.77" x 0.89" x 1.5"	SensaSwitch, Manual- ON/Auto-OFF	ASVS12W4 ASVS12M4	2.66" x 1.77" x 1.85"
Paddle Fan Speed Control	AAFN4S16AW4 AAFN4S16AM4	2.66" x 1.77" x 1.85"	SensaSwitch, Manual- ON/Timed-OFF	ASTM2W2 ASTM2M2	2.66" x 1.77" x 1.85"
Whisper Switch	ASWR1532W4 ASWR1532M4	1.77" X 1.77" x 1.63"	SensaDimmer, Auto- ON/Auto-OFF	ADSM703HW2 ADSM703HM2	4.20" x 1.77" x 1.85"
Whisper Dimmer	ADWR703HW4 ADWR703HM4 ADWR1103HW4 ADWR1103HM4	4.20" x 1.77" x 1.77" 4.20" x 2.51" x 1.77"	Wave Switch	ASWW1532W2 ASWW1532M2	2.66" x 1.77" x 1.71"
Whisper Dimmer, Multi-Location Wireless	ADWR700MMUW2 ADWR700MMUM2 ADWR700MMHW2 ADWR700MMHM2 ADWRMRUW2 ADWRMRUM2	4.20" x 1.77" x 1.79" 4.20" x 1.77" x 1.79" 4.20" x 1.77" x 1.79" 4.20" x 1.77" x 1.79"	Touch Switch	ASTH1532W2 ASTH1532M2	2.66" x 1.77" x 1.63"
sofTap Switch	ASTP1532W4 ASTP1532M4	2.66" x 1.77" x 1.63"	Touch Switch, Whole-House Wireless	ASTH155RMW1 ASTH155RMM1 ASTHRRW1 ASTHRRM1	2.66" x 1.77" x 1.63" 2.66" x 1.77" x 1.63"
sofTap Dimmer	ADTP703HW2 ADTP703HM2 ADTP1103HW4 ADTP1103HM4 ADTP703UW2 ADTP703UM2	4.20" x 1.77" x 1.79" 4.20" x 2.51" x 1.79" 4.20" x 1.77" x 1.79" 4.20" x 1.77" x 1.79"	Touch Dimmer, Multi-Location Wireless	ADTH700MMUW2 ADTH700MMUM2 ADTHMRUW2 ADTHMRUM2	4.20" x 1.77" x 1.79" 4.20" x 1.77" x 1.79"
sofTap Switch, Multi-Location Wireless	ASTPRF2W2 ASTPRF2M2 ASTPRFR2W2 ASTPRFR2M2	2.66" x 1.77" x 1.63" 2.66" x 1.77" x 1.63"	Touch Dimmer, Whole-House Wireless	ADTH700RMHW1 ADTH700RMHM1 ADTH700RMUW1 ADTH700RMUM1 ADTHRRW1 ADTHRRM1	4.20" x 1.77" x 1.79"
sofTap Switch, Whole-House Wireless	ASTP155RMW1 ASTP155RMM1 ASTPRRW1 ASTPRRM1	2.66" x 1.77" x 1.63" 2.66" x 1.77" x 1.63"	Blank, 1-Module	AABK1W4 AABK1M4	1.77" X 0.89" x 0.96"
sofTap Dimmer, Multi-Location Wireless	ADTP700MMUW2 ADTP700MMUM2 ADTP700MMHW2 ADTP700MMHM2 ADTPMRUW2 ADTPMRUM2	4.20" x 1.77" x 1.79" 4.20" x 1.77" x 1.79" 4.20" x 1.77" x 1.79" 4.20" x 1.77" x 1.79"	Tamper-Resistant Outlet, 2-Module	ARTR152W4 ARTR152M4 ARTR202W4 ARTR202M4	2.12" x 1.77" x 1.73" 2.12" x 1.77" x 1.73"
sofTap Dimmer, Whole-House Wireless	ADTP700RMHW1 ADTP700RMHM1 ADTP700RMUW1 ADTP700RMUM1 ADTPRRW1 ADTPRRM1	4.20" x 1.77" x 1.79" 4.20" x 1.77" x 1.79"	Tamper Resistant Out- let, 3-Module	ARTR153W4 ARTR153M4	3" x 1.77" x 1.48"
			Tamper-Resistant GFCI, 2-Module	AGFTR152W4 AGFTR152M4 AGFTR202W4 AGFTR202M4	2.66" x 1.77" x 1.82" 2.66" x 1.77" x 1.82"
			Tamper-Resistant GFCI, 3-Module	AGFTR153W4 AGFTR153M4	3.00" x 1.76" x 1.82"
			Energy-Saving ON/OFF Outlet	ARPS152W4 ARPS152M4	2.66" x 1.77" x 1.73"
			Wireless Outlet	ARPS15RF2W4 ARPS15RF2M4	2.66" x 1.76" x 1.82"
			USB Outlet, 1-Module	ARUSBW4 ARUSBM4	1.77" X 0.89" x 1.81"