

RL530-12W-120V-DIM-FL / RL507-12W-120V-DIM-FL

Module LED - Elite Lighting Module LED Lighting Component



► UNIQUELY ENGINEERED FOR NEW AND EXISTING CONSTRUCTION

The Elite **Module LED** has been engineered for new construction where Title-24's "No Edison Socket" mandate has been initiated. A dedicated housing installs the same as any other Elite Lighting product and features our adjustable, lockable and tiltable nail bars. The **Module LED** can also be installed into most 5-inch incandescent downlights by using our unique Edison adapter.

Over 500 usable lumens are directed from the luminaire to the work surface. Lighting is smooth and comfortable, all while using 75% less energy than the equivalent 65W BR30 and 25% less than the common 18W CFL. Plus the Elite **Module LED** features 50,000 hours life, and California Title-24 compliance.

FEATURES

Greater light output than a 18W CFL or an 65W BR30 while consuming less than 12W of power.

► OPTICS

Anyone can mount a chip to a heat sink and make a down light.

Gather the light scattered by the LED chip, shape it into a functional beam with a state of the art reflector, integrate the light through a smooth reflector to minimize brightness, then top it all off with a glare reducing cone that has a 55-degree cut-off. Now you have the Elite-engineered, superior quality, **Module LED** consuming less than 12 watts and producing over 500 lumens.

INSTALLATION



- Socket adapter removes from module, allowing installation to be quick and easy. Simply screw in the adapter and plug in the module. Turning off the entire module is not required.
- Utilizes industry standard V or torsion springs, installs in most 5" incandescent down lights. Insert torsion springs into can and press trim to ceiling.

► DURABILITY

Die-cast aluminum housing and heat management system are engineered for extremely long life and service period. Without proper heat management, any LED luminaire will fail. Our die-cast system pulls the heat from the LED chip, allowing the continued cool operation for years. Life tests have shown the Elite **Module LED** light output will be maintained at 70% of initial at 50,000 hours of operation. Our superior design allows for installation in construction that requires the Elite Air-Shut™ system. Our LED driver is rated for 50 to 60 Hz at 120V input, produces less than 10% THD, has a power factor between 0.90 and 1.00 and is thermal protected for additional safety. In installations requiring 277V, we offer a step-down transformer option that is field installable.

► REPEATABLE

Repeatability means quality. From our chip selection process, to our driver, to the thermal management, the Elite LED Module is engineered for quality. All Elite LED luminaires are rated at 85+ CRI and 27K, 30K, 35K, 40K and 51K, as rated and tested to LM-79 and LM-80 standards by an outside laboratory, and meets the California Title-24 compliance standards. Our stringent chip specifications to accept only those chips that produce no ultra violet light and with very minimal infrared.

► DIMMABLE

The Elite LED is dimmable down to 15% of initial light output by using an electronic low voltage dimmer. The following Lutron dimmers have been tested to be compatible with RL530-12W-120V-DIM-FL/ RL507-12W-120V-DIM-FL system: • MAELV-600 • DVELV-600 • RAELV-500L • HOME WORKS OR GRAFIK-EYE • VANTAGE LIGHTING SYSTEMS. When using any of these dimmers, all power ratings and installation instructions from dimmer manufacturer must be followed. Dimmer control must have same AC input rating as the dimmable power supply driver it connects to. Other electronic low voltage dimmers may be compatible, but have not been tested by Elite LED Lighting.

► INTERCHANGEABLE

The Elite **Module LED** system works in our dedicated (LD51C-AT, LD51R-AT) housings and our existing 5" incandescent housings (or standard B5, B5R, B51C-AT and B51R-AT) but is also suitable for using in most 5-inch recessed downlight housing.

► ADAPTABLE

All Elite **Module LED** luminaires are shipped standard with our custom engineered Edison adapter. This adapter assembly allows the luminaires to install directly into existing Elite 5" downlight housings and most other 5-inch downlight housings.

► OUR WORD

The Elite **Module LED** is warranted for 3 years of flawless operation. As a system, we stand behind the entire Elite products from housing to bar hangers. When the **Module LED** is installed in retrofit applications, only the **Module LED** itself is warranted.



CERTIFICATIONS

- cULus
- California Title 24
- IECC
- New York state
- Washington state
- RoHS

RL530-12W-120V-DIM-FL / RL507-12W-120V-DIM-FL

Module LED - Elite Lighting Module LED Lighting Component

DIMENSION

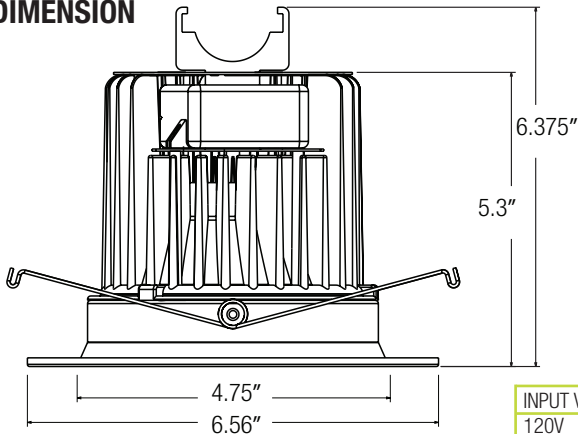

INPUT VOLT.	INPUT FREQ.	INPUT CUR.	LED DRIVER CUR.	INPUT POWER	LED POWER	THD	POWER FACTOR
120V	60Hz	100mA	340mA	12W(+/-5%)	12W	9%	>0.9

PHOTOMETRICS

TRIM: RL530-12W-120V-DIM-FL-30K TEST NO.: LLI 0809-14A LUMENS: 500 SPACING CRITERIA: .70

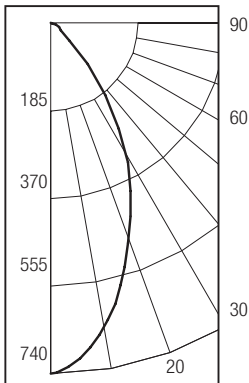

Zonal Lumens Summary

Zone	Lumens	%Lamp	%Fixt
0-30	358.84	N.A.	71.6
0-40	453.97	N.A.	90.6
0-60	498	N.A.	99.4
0-90	501.1	N.A.	100

Total Luminaire Efficacy = N.A.

Candela Tabulation

0	740.1
5	727.8
15	529.0
25	316.1
35	152.0
45	42.9
55	8.6
65	2.8
75	0
85	0
90	0



ITEM SELECTOR: (Please check the boxes below for the option desired)

TYPE	WATTAGE	VOLTAGE	DIMMABLE	OPTICS	COLOR	FINISH
RL530	<input type="checkbox"/> 12W	<input type="checkbox"/> 120	<input type="checkbox"/> DIM	<input type="checkbox"/> FL	<input type="checkbox"/> 27K <input type="checkbox"/> 40K	<input type="checkbox"/> W-WH <input type="checkbox"/> CP-CP
					<input type="checkbox"/> 30K <input type="checkbox"/> 51K	<input type="checkbox"/> P-WH <input type="checkbox"/> BZ-BZ
Example: RL530-12W-120-DIM-FL-30K-W-WH					<input type="checkbox"/> 35K	<input type="checkbox"/> SN-SN <input type="checkbox"/> P-BK

ITEM SELECTOR: (Please check the boxes below for the option desired)

TYPE	WATTAGE	VOLTAGE	DIMMABLE	OPTICS	COLOR	FINISH
RL507	<input type="checkbox"/> 12W	<input type="checkbox"/> 120	<input type="checkbox"/> DIM	<input type="checkbox"/> FL	<input type="checkbox"/> 27K <input type="checkbox"/> 40K	<input type="checkbox"/> CL-WH <input type="checkbox"/> RG-WH <input type="checkbox"/> SN-WH
					<input type="checkbox"/> 30K <input type="checkbox"/> 51K	<input type="checkbox"/> CP-WH <input type="checkbox"/> MB-WH <input type="checkbox"/> SN-SN
					<input type="checkbox"/> 35K	<input type="checkbox"/> W-WH <input type="checkbox"/> CL-CH <input type="checkbox"/> RG-PB
						<input type="checkbox"/> BZ-BZ <input type="checkbox"/> CP-CP <input type="checkbox"/> MB-BK

Example: RL507-12W-120-DIM-FL-30K-W-WH

5" LED RETROFIT DESIGNED TO FIT INTO EXISTING INCANDESCENT DOWNLIGHT



Photometric Multiplier 1.0

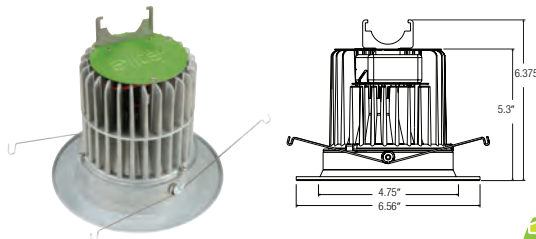

RL530-12W-120V-DIM-FL-__K-W-WH

Available Color Temp: (27K) (30K) (35K) (40K) (51K)

LED (Retrofit) Die-cast Aluminum Lensed White Stepped Baffle with White Trim Ring

New construction housing: **LD5IC-AT***

Remodel housing: **LD5RIC-AT***

**For non retrofit applications housing must be ordered separately*



Photometric Multiplier .92

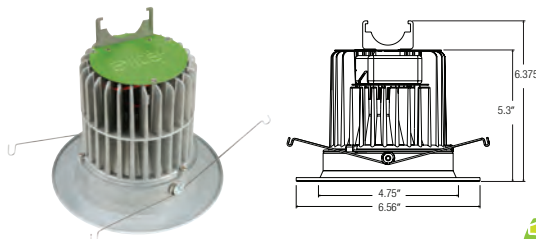

RL530-12W-120V-DIM-FL-__K-SN-SN

Available Color Temp: (27K) (30K) (35K) (40K) (51K)

LED (Retrofit) Die-cast Aluminum Lensed Satin Nickel Stepped Baffle with Satin Nickel Trim Ring

New construction housing: **LD5IC-AT***

Remodel housing: **LD5RIC-AT***

**For non retrofit applications housing must be ordered separately*



Photometric Multiplier .75

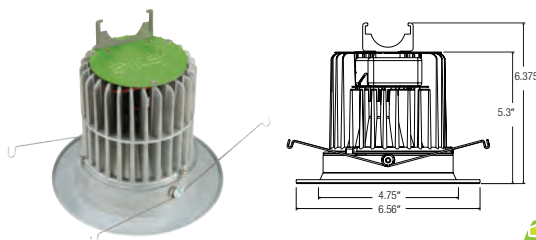

RL530-12W-120V-DIM-FL-__K-P-BK

Available Color Temp: (27K) (30K) (35K) (40K) (51K)

LED (Retrofit) Die-cast Aluminum Lensed Black Stepped Baffle with Black Trim Ring

New construction housing: **LD5IC-AT***

Remodel housing: **LD5RIC-AT***

**For non retrofit applications housing must be ordered separately*



5" LED RETROFIT DESIGNED TO FIT INTO EXISTING INCANDESCENT DOWNLIGHT

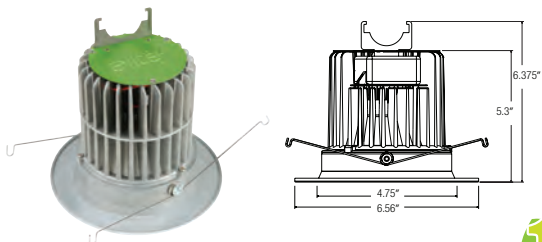

RL530-12W-120V-DIM-FL- K-CP-CP

Available Color Temp: (27K) (30K) (35K) (40K) (51K)



LED (Retrofit) Die-cast Aluminum Lensed Copper Stepped Baffle with Copper Trim Ring

New construction housing: **LD51C-AT***

Remodel housing: **LD5RIC-AT***

**For non retrofit applications housing must be ordered separately*

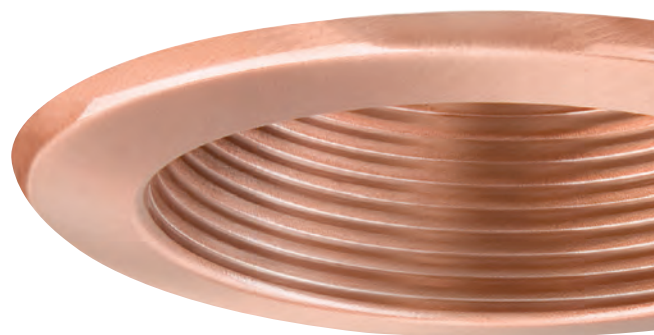

Photometric Multiplier .87

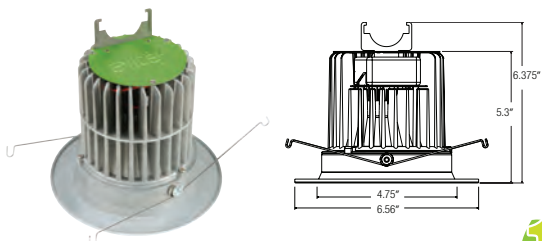

RL530-12W-120V-DIM-FL- K-BZ-BZ

Available Color Temp: (27K) (30K) (35K) (40K) (51K)



LED (Retrofit) Die-cast Aluminum Lensed Bronze Stepped Baffle with Bronze Trim Ring

New construction housing: **LD51C-AT***

Remodel housing: **LD5RIC-AT***

**For non retrofit applications housing must be ordered separately*



Photometric Multiplier .85

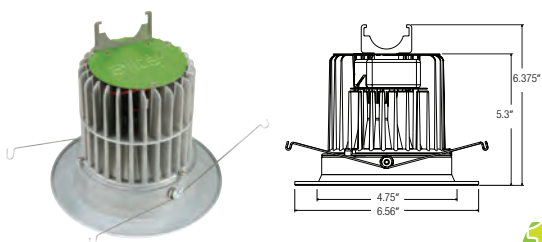

RL530-12W-120V-DIM-FL- K-P-WH

Available Color Temp: (27K) (30K) (35K) (40K) (51K)



LED (Retrofit) Die-cast Aluminum Lensed Black Stepped Baffle with White Trim Ring

New construction housing: **LD51C-AT***

Remodel housing: **LD5RIC-AT***

**For non retrofit applications housing must be ordered separately*



Photometric Multiplier .75

5" LED RETROFIT DESIGNED TO FIT INTO EXISTING INCANDESCENT DOWNLIGHT



Photometric Multiplier 1.0

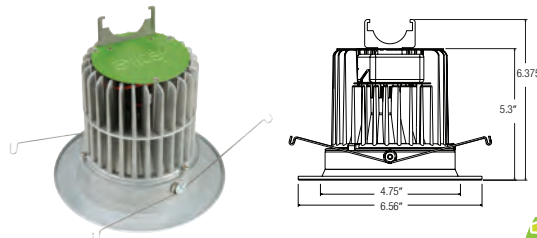

RL507-12W-120V-DIM-FL- K-CL-WH

Available Color Temp: (27K) (30K) (35K) (40K) (51K)



LED (Retrofit) Die-cast Aluminum Lensed Chrome Reflector with White Trim Ring

New construction housing: **LD5IC-AT***

Remodel housing: **LD5RIC-AT***

**For non retrofit applications housing must be ordered separately*



Photometric Multiplier 1.0

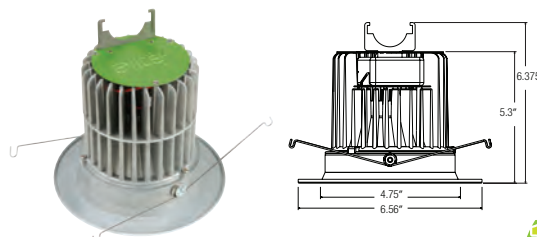

RL507-12W-120V-DIM-FL- K-CL-CH

Available Color Temp: (27K) (30K) (35K) (40K) (51K)



LED (Retrofit) Die-cast Aluminum Lensed Chrome Reflector with Chrome Trim Ring

New construction housing: **LD5IC-AT***

Remodel housing: **LD5RIC-AT***

**For non retrofit applications housing must be ordered separately*



Photometric Multiplier .95

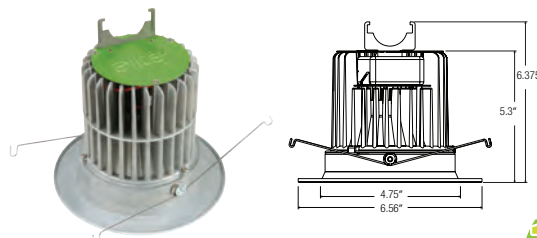

RL507-12W-120V-DIM-FL- K-W-WH

Available Color Temp: (27K) (30K) (35K) (40K) (51K)



LED (Retrofit) Die-cast Aluminum Lensed White Reflector with White Trim Ring

New construction housing: **LD5IC-AT***

Remodel housing: **LD5RIC-AT***

**For non retrofit applications housing must be ordered separately*

5" LED RETROFIT DESIGNED TO FIT INTO EXISTING INCANDESCENT DOWNLIGHT

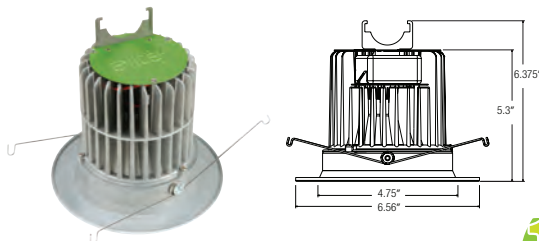

RL507-12W-120V-DIM-FL- K-SN-SN

Available Color Temp: **(27K) (30K) (35K) (40K) (51K)**

LED (Retrofit) Die-cast Aluminum Lensed Satin Nickel Reflector with Satin Nickel Trim Ring

New construction housing:	LD5IC-AT*
Remodel housing:	LD5RIC-AT*

**For non retrofit applications housing must be ordered separately*



Photometric Multiplier .87

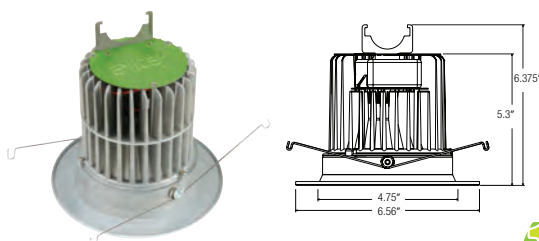

RL507-12W-120V-DIM-FL- K-SN-WH

Available Color Temp: **(27K) (30K) (35K) (40K) (51K)**

LED (Retrofit) Die-cast Aluminum Lensed Satin Nickel Reflector with White Trim Ring

New construction housing:	LD5IC-AT*
Remodel housing:	LD5RIC-AT*

**For non retrofit applications housing must be ordered separately*



Photometric Multiplier .87

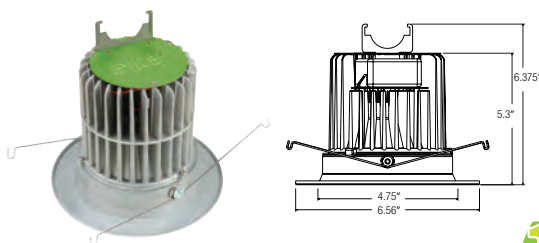

RL507-12W-120V-DIM-FL- K-RG-PB

Available Color Temp: **(27K) (30K) (35K) (40K) (51K)**

LED (Retrofit) Die-cast Aluminum Lensed Gold Reflector with Polish Brass Trim Ring

New construction housing:	LD5IC-AT*
Remodel housing:	LD5RIC-AT*

**For non retrofit applications housing must be ordered separately*



Photometric Multiplier .90

5" LED RETROFIT DESIGNED TO FIT INTO EXISTING INCANDESCENT DOWNLIGHT



Photometric Multiplier .90

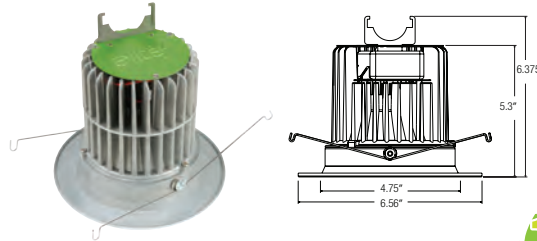

RL507-12W-120V-DIM-FL- K-CP-CP

Available Color Temp: (27K) (30K) (35K) (40K) (51K)



LED (Retrofit) Die-cast Aluminum Lensed Copper Reflector with Copper Trim Ring

New construction housing: **LD5IC-AT***

Remodel housing: **LD5RIC-AT***

**For non retrofit applications housing must be ordered separately*



Photometric Multiplier .87

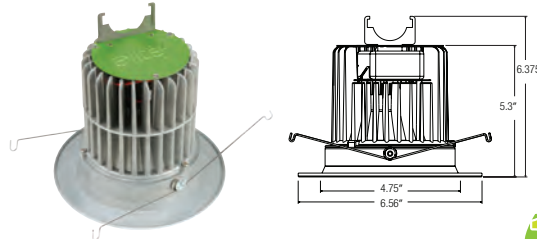

RL507-12W-120V-DIM-FL- K-BZ-BZ

Available Color Temp: (27K) (30K) (35K) (40K) (51K)



LED (Retrofit) Die-cast Aluminum Lensed Bronze Reflector with Bronze Trim Ring

New construction housing: **LD5IC-AT***

Remodel housing: **LD5RIC-AT***

**For non retrofit applications housing must be ordered separately*



Photometric Multiplier .90

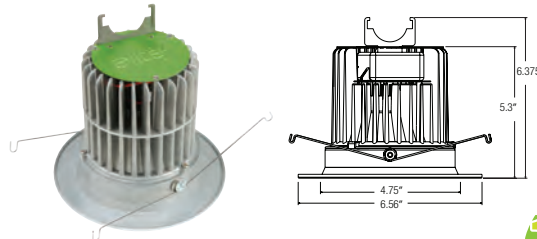

RL507-12W-120V-DIM-FL- K-RG-WH

Available Color Temp: (27K) (30K) (35K) (40K) (51K)



LED (Retrofit) Die-cast Aluminum Lensed Gold Reflector with White Trim Ring

New construction housing: **LD5IC-AT***

Remodel housing: **LD5RIC-AT***

**For non retrofit applications housing must be ordered separately*

5" LED RETROFIT DESIGNED TO FIT INTO EXISTING INCANDESCENT DOWNLIGHT

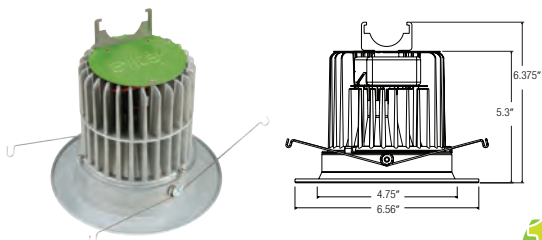

RL507-12W-120V-DIM-FL- K-CP-WH

Available Color Temp: (27K) (30K) (35K) (40K) (51K)



LED (Retrofit) Die-cast Aluminum Lensed Copper Reflector with White Trim Ring

New construction housing: **LD5IC-AT***

Remodel housing: **LD5RIC-AT***

**For non retrofit applications housing must be ordered separately*



Photometric Multiplier .90

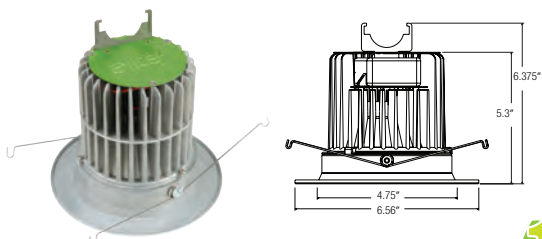

RL507-12W-120V-DIM-FL- K-MB-BK

Available Color Temp: (27K) (30K) (35K) (40K) (51K)



LED (Retrofit) Die-cast Aluminum Lensed Black Reflector with Black Trim Ring

New construction housing: **LD5IC-AT***

Remodel housing: **LD5RIC-AT***

**For non retrofit applications housing must be ordered separately*



Photometric Multiplier .77

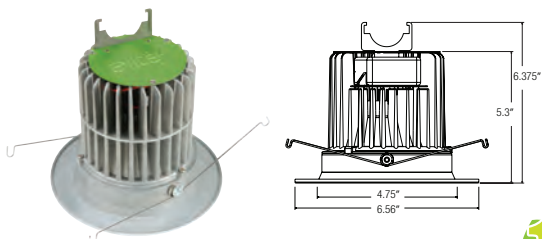

RL507-12W-120V-DIM-FL- K-MB-WH

Available Color Temp: (27K) (30K) (35K) (40K) (51K)



LED (Retrofit) Die-cast Aluminum Lensed Black Reflector with White Trim Ring

New construction housing: **LD5IC-AT***

Remodel housing: **LD5RIC-AT***

**For non retrofit applications housing must be ordered separately*



Photometric Multiplier .77