



# TRAC 12/25

Project: \_\_\_\_\_

Fixture Type: \_\_\_\_\_

Location: \_\_\_\_\_

Contact/Phone: \_\_\_\_\_

Miniature 25-Amp Low Voltage Trac System

## TRAC SECTIONS, FEEDS, JOINERS AND PENDANT MOUNTINGS

### TLR2, TLR4, TLR6 and TLR8

### PRODUCT DESCRIPTION

Miniature, single-circuit trac sections for operation with 12 volt or 24 volt step down transformers as listed on pages [D3.1.2](#), [D3.1.3](#), [D5.4.0](#) and [D5.4.1](#) (except TL546). Each trac section is supplied with dead end and is compatible with electrical feeds, joiner connectors and accessories as listed on this spec sheet, to permit NEC code-compliant installations. Accepts all Trac12 cove, accent and pendant lampholders.

### PRODUCT SPECIFICATIONS

**Construction** Extruded "1" beam channel aluminum for maximum strength • Injection molded polycarbonate dead-end with set screw  
• Standard lengths may be cut-to-length by installer.

**Electrical** Two 10 gauge solid copper conductors • Rated 25 amps at 12 or 24 volts.

**Labels** UL listed, CSA certified.

Product specifications subject to change without notice.

### PRODUCT INSTALLATION

Supplied with toggle bolts for surface mounting • Use with system components listed below to complete trac system.

### DIMENSIONS

#### Surface Mounted Trac 12/25

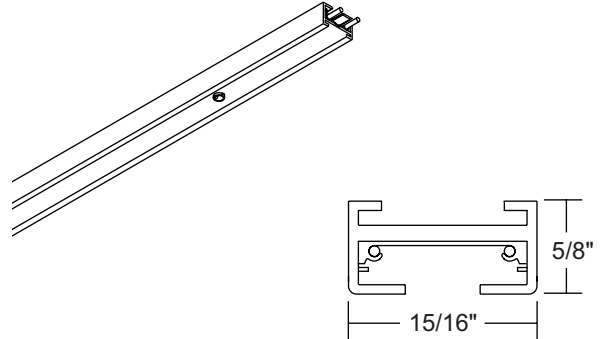

### PRODUCT CODES

Catalog Number	Description	Actual Length	Finish
TLR2WH	2' Trac Section	20 <sup>5</sup> / <sub>8</sub> "	White
TLR2BL	2' Trac Section	20 <sup>5</sup> / <sub>8</sub> "	Black
TLR2SL	2' Trac Section	20 <sup>5</sup> / <sub>8</sub> "	Silver
TLR4WH	4' Trac Section	44 <sup>5</sup> / <sub>8</sub> "	White
TLR4BL	4' Trac Section	44 <sup>5</sup> / <sub>8</sub> "	Black
TLR4SL	4' Trac Section	44 <sup>5</sup> / <sub>8</sub> "	Silver
TLR6WH	6' Trac Section	68 <sup>5</sup> / <sub>8</sub> "	White
TLR6BL	6' Trac Section	68 <sup>5</sup> / <sub>8</sub> "	Black
TLR6SL	6' Trac Section	68 <sup>5</sup> / <sub>8</sub> "	Silver
TLR8WH	8' Trac Section	92 <sup>5</sup> / <sub>8</sub> "	White
TLR8BL	8' Trac Section	92 <sup>5</sup> / <sub>8</sub> "	Black
TLR8SL	8' Trac Section	92 <sup>5</sup> / <sub>8</sub> "	Silver

### Electrical Feeds (12V or 24V)

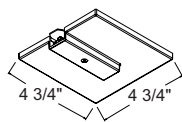

**TLR21WH, TLR21BL, TLR21SL**  
End Feed Connector and Outlet Box Cover. Allows trac to be fed via remote transformer from an outlet box. Includes terminal block and mounting plate cover.

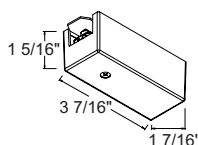

**TLR34WH, TLR34BL, TLR34SL**  
End Feed Connector and Conduit Feed. Allows trac to be fed via remote transformer with conduit through the end or top using standard 1/2" electrical connectors. Includes terminal block feed connector, mounting plate and cover.

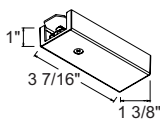

**TLR38WH, TLR38BL, TLR38SL**  
End Feed Connector. Allows trac to be via remote transformer from top using standard electrical connectors. Includes terminal block connector, mounting plate and cover.

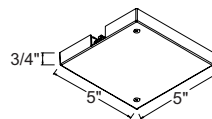

**TLR36WH, TLR36BL, TLR36SL**  
Outlet Box/T-Bar Ceiling Canopy. Covers over outlet boxes or on T-Bar ceiling to feed up to 4 tracs via a remote transformer. Includes one TLR36TB, mounting plate and cover. To feed more than one trac, order additional TLR36TB connectors. Requires TLR37 for T-Bar installation.

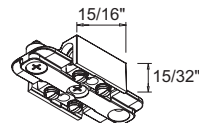

**TLR36TB-WH, TLR36TB-BL**  
Terminal Block for TLR36.

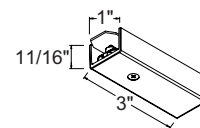

**TLR50WH, TLR50BL, TLR50SL**  
Pendant Feed End Connector. For use in conjunction with TLR90/91 Pendant Stem or TLR96 Cable Feed assemblies to feed power into end of trac. Includes terminal block connector, support plate and cover.

# TRAC 12/25

## Miniature 25-Amp Low Voltage Trac System

### TRAC SECTIONS, FEEDS, JOINERS AND PENDANT MOUNTINGS

#### TLR2, TLR4, TLR6 and TLR8

#### Joiner Connectors (12V or 24V)

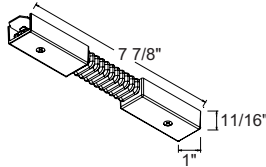

**TLR20WH, TLR20BL, TLR20SL**  
Accordion Adjustable Joiner. Joins two trac sections at variable angles to left, right, up or down. Includes two terminal block connectors, joiner wires and covers.

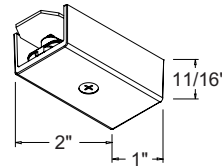

**TLR23WH, TLR23BL, TLR23SL**  
Miniature Straight Connector. Joins two trac sections end-to-end. Includes terminal block joiner and cover.

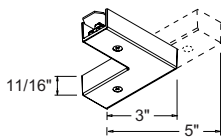

**TLR24WH, TLR24BL, TLR24SL**  
Adjustable Connector. Joins two trac sections to form a 90-degree corner or straight coupling. Includes two terminal block connectors, joiner wires and covers.

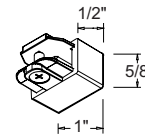

**TLR28WH, TLR28BL, TLR28SL**  
Dead End. Use on extra field-cut trac sections.

#### Accessories



**TLR37**  
15/16" T-Bar Attachment Clip. To attach Trac 12/25 to inverted tee ceilings using flush or drop tiles. Use one for every 4' of Trac 12/25 trac.

**TLR37-9-16**  
9/16" T-Bar Attachment Clip. To attach Trac 12/25 to inverted tee ceilings using flush or drop tiles. Use one for every 4' of Trac 12/25 trac.

#### Trac 12 Extension Wands



**TLRW12, TLRW18, TLRW24, TLRW36, TLRW48**  
Trac 12 Extension Wands (12", 18", 24", 36", 48")  
Suspend Trac 12 lampholders from Trac 12 or Trac 12/25 trac sections or monopoints. WH, BL, SL

#### Connectors/Mountings

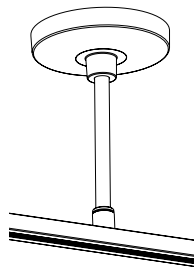

**TLR90-12-WH, BL, SL**  
**TLR90-18-WH, BL, SL**  
**TLR90-24-WH, BL, SL**  
**TLR90-36-WH, BL, SL**  
**TLR90-48-WH, BL, SL**  
Pendant Stem Kit for T-Bar Ceiling. For feed and/or support use. Includes full-size canopy, pendant stem, T-Bar plate with 15/16" T-bar clip and Trac mounting hardware. Feed requires TLR50 Pendant End Feed Connector.

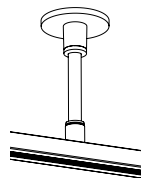

**TLR92-12-WH, BL, SL**  
**TLR92-18-WH, BL, SL**  
**TLR92-24-WH, BL, SL**  
**TLR92-36-WH, BL, SL**  
**TLR92-48-WH, BL, SL**  
Pendant Stem Mechanical Support Kit. Suspends Trac 12/25 from T-Bar ceilings or drywall. Includes Mini-Canopy, pendant stem, 15/16" T-bar clip, drywall anchor and Trac mounting hardware.

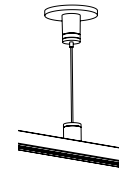

**TLR95-48-WH, BL, SL**  
**TLR95-144-WH, BL, SL**  
Stainless Steel Cable Mechanical Support Kit. Suspends Trac 12/25 from T-bar ceilings or drywall. Includes Mini-Canopy, steel cable, 15/16" T-bar clip, drywall anchor and Trac mounting hardware.

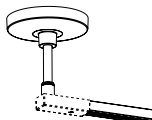

**TLR91-12-WH, BL, SL**  
**TLR91-18-WH, BL, SL**  
**TLR91-24-WH, BL, SL**  
**TLR91-36-WH, BL, SL**  
**TLR91-48-WH, BL, SL**  
Pendant Stem Kit for Junction Box Mounting. For feed and/or support use. Includes full-size canopy, pendant stem, outlet box strap and Trac mounting hardware. Feed requires TLR50 Pendant End Feed Connector.

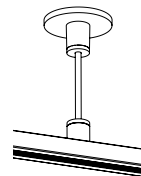

**TLR93WH, BL, SL**  
Threaded Rod Kit Mechanical Support Kit. Mini-canopy with threaded inserts for supporting Trac 12/25 trac using 10-24 threaded rod (not supplied). Provides mechanical support only. Includes Mini-Canopy, 15/16" T-bar clip, drywall anchor and Trac mounting hardware. Compatible with 10-24 threaded rod (not included).

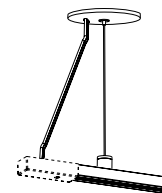

**TLR96-48-WH, BL, SL**  
**TLR96-144-WH, BL, SL**  
Stainless Steel Cable Feed & Mechanical Support. Includes full-size feed/support canopy, steel cable, 10 gauge stranded tandem wire, outlet box strap and Trac mounting hardware. Feed requires TLR50.

For all Trac12/25 mounting accessories, use any combination of two for 2', 4' or 6' trac sections or three for 8' trac section. Stainless steel cable recommended only for trac patterns, not straight runs.

Product specifications subject to change without notice.



1300 S. Wolf Road • Des Plaines, IL 60018 • Phone (847) 827-9880 • Fax (847) 827-2925  
220 Chrysler Drive • Brampton, Ontario • Canada L6S 6B6 • Phone (905) 792-7335 • Fax (905) 792-0064  
Visit us at [www.junolightinggroup.com](http://www.junolightinggroup.com)

Printed in U.S.A. ©2009 Juno Lighting, LLC.