

# HIGH INTENSITY DISCHARGE BALLASTS

Philips Advance HID ballasts are available to operate the wide variety of metal halide, high pressure sodium and low pressure sodium lamps available in today's marketplace.

Like fluorescent, HID lamps are gas discharge lamps. Light is produced by an arc discharge between two electrodes located at opposite ends of an arc tube within the lamp's outer glass envelope. The ballast is the lamp's power supply; its purpose is to provide proper starting and operating voltage and current to initiate and sustain this arc.

## Lamp Starting

### Probe-Start Metal Halide Lamps

The "traditional" probe-start metal halide lamps (175 through 1500W) have an additional electrode located at one end of the arc tube to assist in lamp starting. These types of lamps require an open circuit voltage (OCV) approximately two times the lamp's operating voltage to initiate the arc.

### High Pressure Sodium and Pulse-Start Metal Halide Lamps

High pressure sodium and modern metal halide lamps which include existing lamps, 150W and less, as well as the new generation of pulse-start metal halide lamps, 150W and greater, have no starting electrodes. In addition to an OCV of approximately two times the lamp voltage, these lamps utilize an "ignitor" to provide a high voltage starting pulse directly across the main electrodes. Once the lamp's arc is established, the ignitor automatically stops delivering pulses, and the lamp comes up to full brightness on its own.

### Low Pressure Sodium

Because they have neither a starting electrode nor an ignitor, low pressure sodium lamps require an open circuit voltage approximately three to seven times the lamp voltage to start and sustain the lamp.

### Lamp Operation

Gas discharge lamps have a negative resistance characteristic which causes them to draw an increasing amount of current leading to immediate lamp failure if operated directly from the power line. The ballast, therefore, is utilized to limit the current to the correct level for proper operation of the lamp.

Ballast factor is defined as the ratio of light output produced by a lamp operating on a commercial ballast versus the lamp's rated light output. Philips Advance HID ballasts have a nominal ballast factor of 1.0, thus providing full light output.

HID lamps take several minutes to warm-up and reach full lumen output. Additionally, an interruption in the input power or a sudden voltage drop may cause the arc to extinguish. A lamp that is hot will not restart immediately. Before the lamp will relight, it must cool sufficiently to reduce the vapor pressure within the arc tube to a point where the arc will restrike. The approximate warmup and restriking times of the HID lamp groups are as follows:

Light Source	Warm-Up Time	Restrike Time
Metal Halide (Probe Start)	5-4 minutes	10-20 minutes
Metal Halide (Pulse Start)	2 minutes	3-4 minutes
High Pressure Sodium	3-4 minutes	½-1 minute
Low Pressure Sodium	7-10 minutes	3-12 seconds

## Ballast Input Voltages

Unlike fluorescent lighting which is operated on either 120V or 277V circuits, power for HID lighting in the U.S. is delivered at any one of five voltages: 120V, 208V, 240V, 277V or 480V. While 120V and 277V are the most popular, because of the heavier loads and sometimes longer runs associated with HID lighting (such as shopping mall parking lots), 208V and 240V power is often used instead of 120V, and 480V instead of 277V.

To address this multiplicity of voltages, the HID ballast industry offers ballasts with multiple input voltage taps on the primary coil. Our 4-tap design is called a Quadri-Volt ballast and operates on either 120V, 208V, 240V or 277V line voltage. There is a Philips Advance Quadri-Volt ballast for virtually every HID lamp on the market. New 5-TAP designs, which feature the same input voltages as Quadri-Volt ballasts plus 480V, are available for 250W, 400W, and 1000W metal halide and high pressure sodium applications.

## Luminaires Fusing

Many HID lighting luminaires are sold with protective fuses. The purpose of the fuse is to isolate a luminaire from the lighting circuit in the event of excessive current draw, such as might be caused by a failed ballast. Unfortunately, the fuse will not protect the ballast from failure.

With many luminaires the fuse is physically located in the ballast compartment of the luminaire. The air temperature within this compartment can easily reach 80°C and still be within the design limitations of the luminaire.

Many fuses are temperature sensitive, meaning that the current rating goes down as the ambient temperature goes up. Fuse current ratings are based on the fuse's performance in a 25°C ambient (77°F). In an 80°C ambient, some fuses will open at half their rating.

As a result, the fuse rating shown in the HID ballast tables is calculated at 2½ to 3 times the highest current draw of the ballast: lamp operating starting or open circuit conditions. Typically fast blow fuses should be used. It is not necessary to use current limiting fuses but some applications may require their use. Additional testing is recommended to determine appropriate fuse type.

## Ballast Design Applications

HID lamp ballasts are available in a variety of shapes and sizes for the most popular lighting applications. Six basic designs are in widest use today.

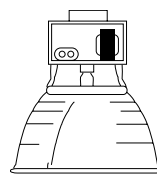

Core & Coil  
(71A Series)

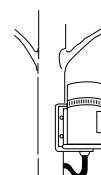

Outdoor Weatherproof  
(79W Series)

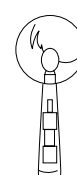

Postline  
(74P Series)

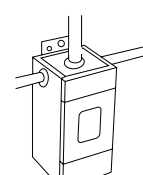

Indoor Enclosed  
Rectangular Can  
(78E Series)

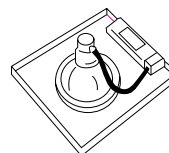

Fluorescent Can  
(72C Series)

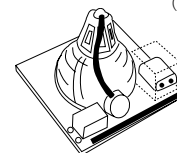

Encapsulated Core & Coil  
(73B Series)

# HIGH INTENSITY DISCHARGE BALLASTS

## Core & Coil

The basic ballast is the open core & coil which is most often used as a component within a lighting luminaire. The core & coil also forms the nucleus of the five other ballast configurations detailed in this section. It consists of either one or two copper coils on a core (or "stack") of electrical-grade steel laminations. The coils are assembled to core sections which are then surface-welded together. The assembled Philips Advance ballast is vacuum-pressure impregnated with a silica-filled polyester varnish to re-enforce the electrical insulation, preclude moisture, inhibit noise, and dissipate heat. Some HID ballast manufacturers apply varnish via a preheat-and-dip process which only puts a thin coat of varnish on the outer surface of the ballast. Philips Advance Core & Coil ballasts feature as standard an insulation system rated class H (180°C maximum coil hot spot temp.) for ballasts below 600W, and Class N (200°C maximum coil hot spot temp.) for ballasts 600W and higher. When performing in-fixture testing, the maximum allowable average coil temperature (measured by the rise-of-resistance method) is 165°C for Class H ballasts or 185°C for Class N ballasts. The maximum allowable coil face or lead wire temperature (measured by thermocouple) is 150°C for both Class H and Philips Advance Class N ballasts, 170°C for true Class N ballasts.

## Encapsulated Core & Coil

Where quiet performance is required, the standard open core & coil ballasts are encapsulated (potted) in a cube-shaped steel can utilizing Class H (180°C) polyester compound. These ballasts carry a Class A noise rating up through 175W and Class B for 250 and 400W. As with the open core & coil, the capacitor (and ignitor where included) are mounted separately within the fixture.

## Ballasts with Aluminum Coils

We offer a wide range of ballasts that have coils made out of copper and/or aluminum. All Philips Advance ballasts adhere to ANSI specifications and are certified by respective agencies (UL, CSA, etc.). Ballasts with aluminum coil(s) are designated by -A after ballast catalog number and/or "AL" on wiring diagram.

## Fluorescent Can (F-Can)

For indoor commercial applications of HID lighting such as offices, schools and retail stores, ballast noise must be minimized. Ballasts for these luminaires are most often encased and potted in fluorescent ballast type cans and utilize Class A (90°C) asphalt insulating materials (the same as used in fluorescent lamp ballasts).

The Philips Advance line of F-can ballasts comes in two dual-voltage configurations: 120/277V for the US market, and 120/347V for the Canadian market. Each unit has built-in, automatically resetting, thermal protectors which disconnect the ballast from the power line in the event of overheating. All units are high power factor and include the capacitor within the can. All models for high pressure sodium, low-wattage metal halide, and pulse-start metal halide lamps also include the ignitor in the can.

Spacing between ballasts and the mounting surface must be considered when the ballasts are remote-mounted. Twelve inches between ballasts must be maintained and if multiple rows vertically are used, there should be at least 12 inches between rows. In addition to ballast and row spacing, the ballast must not be directly mounted to a non-metallic surface. They must be spaced with mounting brackets (see page 5-47 and 5-48 for mounting bracket details) to allow airflow under the ballast base.

## Indoor Enclosed

These units are designed for use indoors where the ballast must be mounted remotely from the luminaire. They are most typically used in factories where the luminaire may be mounted in a high-bay where very high ambient temperatures may be experienced. In these instances, the remotely-mounted ballast operates cooler, subsequently providing longer life because it is away from both the heat of the ceiling ambient and lamp heat within the fixture.

The case contains the core & coil potted in a Class H (180°C) heat-dissipating resin. The capacitor(s) and ignitor are contained within a separate compartment. Knockouts in both ends of the case facilitate hook-up in the most convenient manner. Wall mounting is accomplished through flanges on the top and bottom of the case. The ballast is a UL Listed product.

## Outdoor Weatherproof

Weatherproof ballasts are designed for remote, pole-mounting outdoor applications under all weather conditions. They may also be placed inside of a transformer pole base, but care must be taken to avoid areas prone to flooding because weatherproof ballasts are not water-submersible.

The core & coil with its capacitor and ignitor (where required) are firmly mounted to the heat-sink base. An aluminum cover is placed over the core-&-coil assembly and is bolted with a weather-tight gasket to the base. An integral 1" threaded nipple with locknut facilities hook-up to electrical conduit or to the mounting bracket when used on a pole. The weatherproof ballast may also be placed nipple-up, with a drip loop in the leads, inside a pole base.

## Postline

Lantern-type fixtures mounted on slender poles often require ballasts which will fit into these poles. Special, elongated core & coil ballasts are potted in resin in cylindrical cans having a 2.55" outside diameter. All include leads necessary for direct connection to a photocell.

The capacitor and ignitor (where required) are included within this can. A ½" threaded nipple is used for vertical mounting, and leads extend from both ends of the can for ease of installation. The input leads to the ballast also provide for proper connection to the photocell if such is included within the luminaire.

To help prevent overheating, one to three feet of air space should be allowed in the pole above the ballast, and the ballast should be positioned against the post interior wall to provide a heat-sink. All units rated 100W and above now include a mounting kit consisting of an 18" chain to hang the ballast within the pole and a spring clip to force the ballast's cylindrical can to make line contact with the pole's interior surface to maximize heat transfer, thus prolonging the ballast life.

# HIGH INTENSITY DISCHARGE BALLASTS

## Ballast Date and Temperature Codes

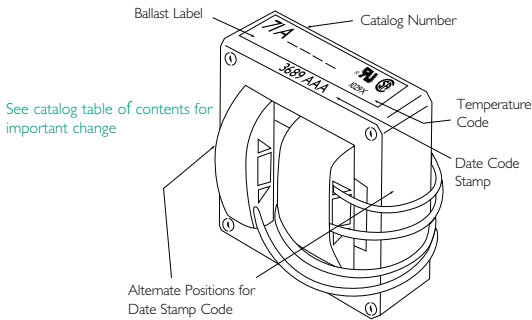

Philips Advance HID Core & Coil ballasts are date stamped on either the top surface or the side surface of the ballast core. The four-digit number represents the week and year of manufacture. The first two numbers indicate the week and the last two indicate the year the ballast was manufactured. The example shows a ballast manufactured during the 36th week of 1989. The three letters are a factory code.

The ballast's UL Bench Top Rise Temperature Code is shown on the label (see below).

### UL Bench Top Rise Temperature Code

To facilitate UL inspection, each ballast's UL Bench Top Rise Temperature Code is shown on the Philips Advance Core & Coil ballast label as 1029X, where 1029 is the UL Standard for HID Ballasts, and the X is the temperature code: A, B, C, etc. If a fixture is UL listed for 1029C, then automatically, all ballasts with an A, B, or C temperature classification are acceptable for use within that same fixture.

UL Bench Top Rise Letter Code	Temperature Range for Class H (180°C) Ballasts	Temperature Range for Class N (200°C) Ballasts
A	less than 75°C	less than 95°C
B	75°C < 80°C	95°C < 100°C
C	80°C < 85°C	100°C < 105°C
D	85°C < 90°C	105°C < 110°C
E	90°C < 95°C	110°C < 115°C
F	95°C < 100°C	115°C < 120°C
etc.	etc.	etc.

## Certifications



Indicates ballast is listed by Underwriters Laboratories, Inc. in accordance with UL 1029 Standard for HID Ballasts. Each ballast is marked appropriately. (UL File Number E94520)



Indicates ballast is component recognized by Underwriters Laboratories, Inc. in accordance with UL 1029 Standard for HID Ballasts. Each ballast is marked appropriately.



Indicates ballast is certified by Canadian Standards Association in accordance with CAN/CSA-22.2 No. 74-92. Each ballast is marked appropriately.



All HID Ballasts are designed and manufactured in accordance with the American National Standards Institute Standard for HID Ballasts, ANSI C82.4.



Indicates ballast is certified and compliant with "Norma Obligatoria Mexicana" (NOM) requirements



Indicates ballast meets the 88% efficiency requirements of EISA (Energy Independence and Security Act of 2007).

EISA requires all 150W-500W metal halide luminaires manufactured on or after January 1, 2009, to contain a ballast meeting the following levels of efficiency:

- 88% for magnetic or electronic pulse start ballasts
- 94% for magnetic probe start ballasts
- 92% for non-pulse start electronic ballasts for wattages greater than 250W, and
- 90% for non-pulse start electronic ballasts for wattages up to 250W

Please refer to the EISA brochure found on the [www.philips.com/advance](http://www.philips.com/advance) website for additional info on EISA-Compliant Pulse Start ballasts.

# HIGH INTENSITY DISCHARGE BALLASTS

## Ordering Information

We have developed the industry's broadest selection of HID ballasts. More than 3000 stocking distributors nationwide. For information on the distributor best able to serve your needs, please call 800-372-3331.

## Philips Advance HID Ballast Part Number Explanation

71A	60	9	2	-500DAEE								
<p><b>Suffix Code*</b> (as applicable)</p> <ul style="list-style-type: none"> <li>-001DB ballast replacement kit with dry capacitor and integral ignitor</li> <li>-001D ballast replacement kit with dry film capacitor</li> <li>-001 ballast replacement kit with oil filled capacitor</li> <li>-500D core &amp; coil ballast with dry film capacitor</li> <li>-500 core &amp; coil ballast with oil filled capacitor</li> <li>-510D core &amp; coil ballast with welded bracket and dry film capacitor</li> <li>-510 core &amp; coil ballast with welded bracket and oil filled capacitor</li> <li>-540D core &amp; coil ballast with welded angle bracket and dry film capacitor</li> <li>-600 core &amp; coil ballast (no capacitor)</li> <li>-610 core &amp; coil ballast with welded bracket (no capacitor)</li> </ul> <p>* Add additional feature codes to the end of suffix where applicable. i.e. -B = Integral Ignitor, -P = Thermally Protected, -J = J-Box Mounting, -A = Aluminum Coil, -ML = "NOM" (with capacitor), -T = 120V Tap -EE = EISA Compliant Ballast</p>												
<p style="text-align: center;"><b>Design Code</b></p> <table style="width: 100%; border: none;"> <tr> <td></td> <td style="text-align: center;"><b>60 Hz Voltages</b></td> <td style="text-align: center;"><b>50 Hz Voltages</b></td> </tr> <tr> <td style="vertical-align: top;"><b>Input Voltage Code</b></td> <td>                     0 = 120V                      1 = 208V                      2 = 240V                      3 = 277V                      4 = 480V                      5 = 120/240V or                      120/208/240/277/480V                      6 = 240/480V                      7 = 120/208/240/277V                      8 = 120/277V                      9 = 120/208/240/277V                 </td> <td>                     A = 120/277/347V                      B = 347V                      C = 120/347V                      D = 120/240/347V                      E = 120/208/240V or 208/240V                      F = 277/480V, 277/347V, 277/347/480V or                      347/480V                      H = 127/220V                      J = 220V or 220/240V                      Y = 100V or 100/200V                 </td> <td>                     M = 100/200V                      N = 120/220-240V                      R = 220/240V                 </td> </tr> </table>						<b>60 Hz Voltages</b>	<b>50 Hz Voltages</b>	<b>Input Voltage Code</b>	0 = 120V 1 = 208V 2 = 240V 3 = 277V 4 = 480V 5 = 120/240V or 120/208/240/277/480V 6 = 240/480V 7 = 120/208/240/277V 8 = 120/277V 9 = 120/208/240/277V	A = 120/277/347V B = 347V C = 120/347V D = 120/240/347V E = 120/208/240V or 208/240V F = 277/480V, 277/347V, 277/347/480V or 347/480V H = 127/220V J = 220V or 220/240V Y = 100V or 100/200V	M = 100/200V N = 120/220-240V R = 220/240V	
	<b>60 Hz Voltages</b>	<b>50 Hz Voltages</b>										
<b>Input Voltage Code</b>	0 = 120V 1 = 208V 2 = 240V 3 = 277V 4 = 480V 5 = 120/240V or 120/208/240/277/480V 6 = 240/480V 7 = 120/208/240/277V 8 = 120/277V 9 = 120/208/240/277V	A = 120/277/347V B = 347V C = 120/347V D = 120/240/347V E = 120/208/240V or 208/240V F = 277/480V, 277/347V, 277/347/480V or 347/480V H = 127/220V J = 220V or 220/240V Y = 100V or 100/200V	M = 100/200V N = 120/220-240V R = 220/240V									
<p style="text-align: center;"><b>Lamp Type/Wattage/Ballast Circuit Code</b></p> <table style="width: 100%; border: none;"> <tr> <td style="vertical-align: top;"><b>Ballast Type</b></td> <td>                     71A = Core and Coil Ballast                      72C = F-Can Ballast                      73B = Encapsulated Core and Coil Ballast                      74P = Postline Ballast                      77L = Val-U-Pak Plus Replacement Ballast kit (includes lamp)                      78E = Indoor Enclosed Ballast                      79W = Outdoor Weatherproof Ballast                 </td> </tr> </table>					<b>Ballast Type</b>	71A = Core and Coil Ballast 72C = F-Can Ballast 73B = Encapsulated Core and Coil Ballast 74P = Postline Ballast 77L = Val-U-Pak Plus Replacement Ballast kit (includes lamp) 78E = Indoor Enclosed Ballast 79W = Outdoor Weatherproof Ballast						
<b>Ballast Type</b>	71A = Core and Coil Ballast 72C = F-Can Ballast 73B = Encapsulated Core and Coil Ballast 74P = Postline Ballast 77L = Val-U-Pak Plus Replacement Ballast kit (includes lamp) 78E = Indoor Enclosed Ballast 79W = Outdoor Weatherproof Ballast											

HID



# 60 Hz Core & Coil Ballasts

## Metal Halide



Input Volts	Catalog <sup>†</sup> Number	Circuit Type	Input Watts	Max Input Current	Nom Open Circuit Voltage	Fuse Rating (Amps)	Wiring Dia	Dimensions			Non-PCB Capacitor (Page 5-38 & 5-39)				Ignitor <sup>††</sup> (Page 5-40 to 5-44)		U.L. Bench Top Rise Code 1029 (pg 5-4)		
								Fig	A	B	Mfd	Min Volt	Cap Catalog Number	Dry or Oil	Total Weight (lbs)	Part Number		Max Dist To Lamp (ft)	
<b>175W Lamp, ANSI Code M57 or 150 Watt Lamp, ANSI Code M107 or 145W lamp, ANSI Code C192 (Philips AllStart)**</b>																			
480	<b>71A5540-001D</b>	CWA	210	0.5	305	2	A	I	2.5	4.0	10	400	7C100M40R	D	8.5	NA	NA	D	
<b>NOM</b>	127/220	71A55H0-500DML	CWA	210	1.8/1.1	305	5/3	A	I	2.5	3.8	10	400	7C100M40R	D	8.0	NA	NA	B/B
<b>NOM</b>	120/208 240/277	71A5590-500D	CWA	210	1.8/1.1/ .9/8	305	5/3/ 3/2	A	I	2.5	3.7	10	400	7C100M40R	D	7.0	NA	NA	C/D/ D/D
	120/208 240/277	<b>71A5570-001D</b>	CWA	210	1.8/1.1/ .9/8	305	5/3/ 3/2	A	I	2.5	3.7	10	400	7C100M40R	D	7.5	NA	NA	C/D/ D/D
	120/ 277/347	71A55A0-500D <b>71A55A0-001D</b>	CWA	210	1.8/ .8/7	305	5/ 2/2	A	I	2.5	3.7	10	400	7C100M40R	D	7.0	NA	NA	C/ C/D
<b>175W Lamp, ANSI Code M137 or M152 (Pulse Start) or 145W Lamp, ANSI Code I92 (Philips AllStart)**</b>																			
<b>E</b>	480/120T	71A5541-500DTEE	Super CWA	198	.04	285	2	M	2	1.8	3.4	11	370	7C110M40	D	10.0	LI533-H4	2	A
<b>E</b>	120/208 240/277	71A5591-500DEE	Super CWA	198	1.7/1.0/ .8/7	285	5/3/ 3/2	M	2	1.7	3.3	11	370	7C110M40	D	10.5	LI533-H4	2	A/A/ A/A
<b>E</b>	480/120T	71A5543-500DTEE	Super CWA	198	.04	278	2	M	I	3.1	4.2	11	370	7C110M40	D	9.4	LI533-H4	2	A
<b>E</b>	120/208 240/277	71A5593-500DEE	Super CWA	198	1.7/1.0/ .9/8	285	5/3/ 3/2	M	I	3.2	4.4	11	370	7C110M40	D	9.7	LI533-H5	2	A/A/ A/A
<b>NOM</b>	120/208 240/277	71A5593-500DML <b>71A5593-001D</b>	Super CWA	208	1.9/1.1/ .9/8	275	5/3/ 3/3	M	I	2.3	3.5	11	370	7C110M40	D	7.0	LI533-H4	2	C/C/ C/C
	120/ 277/347	71A55A3-500D	Super CWA	208	1.9/ .9/7	275	5/ 3/2	M	I	2.3	3.5	11	370	7C110M40	D	7.0	LI533-H4	2	C/ C/C

HID • Core & Coil Metal Halide

<sup>†</sup> Ordering information:

**Replacement/retrofit ballast kits** – indicated by bold type and -001D or -001 suffix. Refer to pages 5-5 to 5-9 for more information on replacement kits.

**Original equipment ballasts** – typically ordered with capacitor (as shown).

- 500D includes core & coil with dry-film capacitor.
- 500 includes core & coil with oil-filled capacitor (required for higher wattage ballasts).

May also be available with welded bracket, and/or without capacitor:

- 510D includes core & coil with welded bracket and dry-film capacitor.
- 510 includes core & coil with welded bracket and oil-filled capacitor.
- 600 core & coil only (no capacitor).
- 610 core & coil with welded bracket (no capacitor).

<sup>††</sup> Each ballast requiring an ignitor is furnished standard with a short-range ignitor model shown for use within fixtures. long-range ignitors are available separately if required. See pages 5-40 to 5-44 for additional information.

• **Maximum Input Current** – For HX and R circuits, value is the highest of starting, operating or open circuit current. For CWA, SCWA and CWI circuits, value is the operating current.

\*\* The 145 Watt Lamp, ANSI Code C192, is an energy saving, screw in replacement lamp for the M57 or M152 lamps, that may reduce input watts up to 15% on existing 175W ballasts.

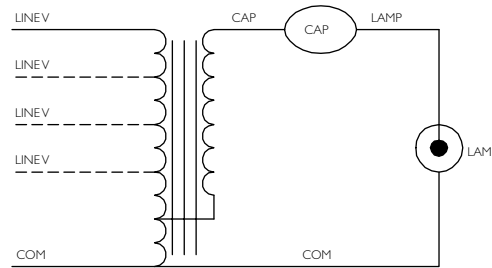

Fig. A

**NOM** Certified ballast available for Mexican market. Add "ML" to suffix (example -500DML). Ballast is branded Philips.

Canadian replacement/retrofit ballast kit indicated by **bold type**. Refer to page 5-9.

Includes auto-reset thermal protection.

Compact 3 x 4 core design

Meets EISA 88% efficiency requirements.

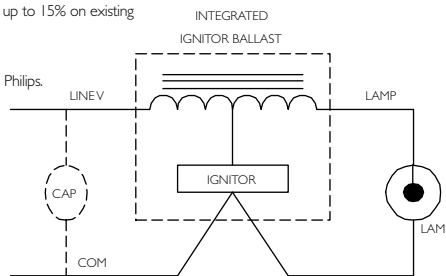

Fig. H

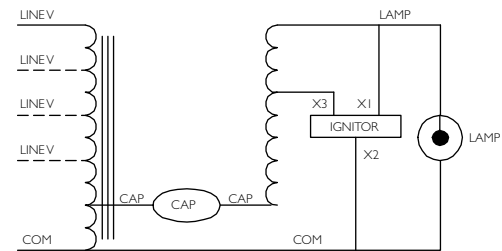

Fig. M