

F Series (available MF Series: Marine Listed with optional hazardous location listing)

Industrial Floodlight - 250-1500 watt HID

Type:	Job:	Approvals:
Catalog Number:		
Series/Source - Wattage (Include M prefix to designate Marine Listed series)	Optics (Reflector / Distribution)	Voltage
Options (Factory Installed)	Finish	Accessories (Field Installed)
Date: Page 1 of 6		

Overall Dimensions

For Reference Only

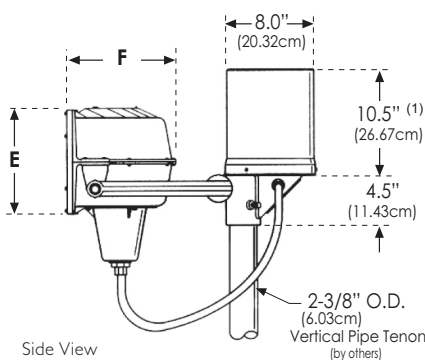
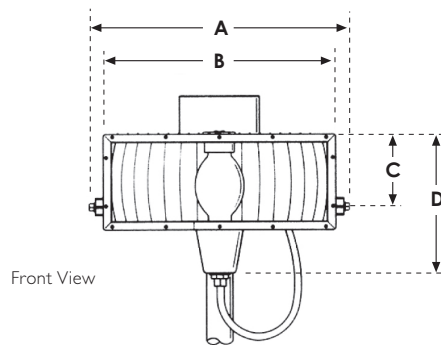

1) With certain dimming options, height of ballast container increases to 14.5" (36.83 cm).

Weight: 66 lbs (29.9 kg)

400 Watt (max) and 1000W PS unit - 23" housing

Note: 23" housing is standard for F series 1000W PS units with BT37 lamp for best lamp stability.
26" housing is required on MF series 1000W PS units with HAZ option (hazardous location listed).

A	B	C	D	E	F
25.5" (64.77cm)	23.0" (58.42cm)	7.3" (18.42cm)	13.8" (34.93cm)	9.5" (24.13cm)	10.0" (25.40cm)

1000-1500 Watt - 26" housing

Exception: Standard F series 1000W PS unit with BT37 lamp requires 23" housing for socket stability. See note above.

A	B	C	D	E	F
27.5" (69.85cm)	26.0" (66.04cm)	9.3" (23.50cm)	18.0" (45.72cm)	13.3" (33.66cm)	11.5" (29.21cm)

EPA data shown on page 3.

Specifications



Housing

Die-cast aluminum housing shall be of marine-grade alloy with integrally cast, heat dissipating fins and a built-in aiming device. Dust-Tite housing shall be totally sealed from particulate entry. Standard unit constructed to IP65.

MF Series, with Marine Listing, constructed to IP66.

Optical Assembly

High purity, 94% minimum reflectivity anodized aluminum reflectors, assembled without machine forming to assure maximum efficiency.

Lamp Access

A gasketed and removable socket assembly provides lamp access from below. Allows re-lamping without re-aiming. High temperature gasket provides positive, weatherproof seal.

Lens

Lens shall be 7/32" clear tempered glass to withstand thermal and physical shock, held in place by an aluminum (extruded: 400W, die-cast: 1000/1500W) lens frame and sealed to housing flange by one extruded, high temperature gasket and stainless steel screws to provide a sealed optical assembly.

Socket

Pre-wired grip-type mogul base socket. Glass end of the lamp is held in precise photometric alignment and protected from breakage by a Stabilux socket.

Ballast

SilentGuard high power factor ballast with reliable starting down to -29°C (-20°F) for Metal Halide, -34°C (-30°F) for Pulse Start Metal Halide, and -40°C (-40°F) for High Pressure Sodium. Ballast has Class H, 180°C (356°F) rated insulation. Crest factor does not exceed 1.8. Core and coil are encapsulated in a polyester resin compound (standard SilentGuard feature) with the capacitor located outside the encapsulation for ease of maintenance. Ballast components are enclosed in a drawn aluminum container. The fixture and ballast are arranged as separate but integral components.

Mounting

Standard cast aluminum ballast base provides integral mastfitter; suitable for mounting to a 2-3/8" O.D. vertical tenon. Alternate mounting accessories available.

Finish

Standard finish shall be textured gray UltraClad polyester powder coating, 2.5 mil nominal thickness, electrostatically applied and oven cured. All components shall be thoroughly cleaned by a 5 stage pre-treatment process including iron phosphate bath and non-chromic acid etching stages, ensuring optimum performance characteristics. Other colors may be specified.

Listings

Standard unit is ETL/cETL listed to the UL 1598 standard, suitable for Wet Locations. Available ETL/cETL listed to the UL 1598A standard - Marine Listing option (MF Series). Available ETL/cETL listed to the UL 844 standard - Hazardous Location Listing available in the US (HAZ option for MF Series only; not available in Canada).

The quality systems of this facility have been registered by UL to the ISO 9001 Series Standards.

Warranty

7 Year Limited Warranty

Some luminaires use fluorescent or high intensity discharge (HID) lamps that contain small amounts of mercury. Such lamps are labeled 'Contain Mercury' and/or with the symbol 'Hg'. Lamps that contain mercury must be disposed of in accordance with local requirements. Information regarding lamp recycle and disposal can be found at www.lamprecycle.org.

F Series (available MF Series: Marine Listed with optional hazardous location listing)

Industrial Floodlight - 250-1500 watt HID

Type:	Job:	Page 2 of 6
--------------	-------------	-------------

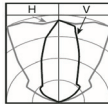
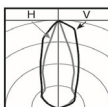
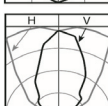
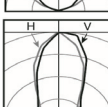

Series/Source-Wattage	Optics (Reflector/Distribution) ⁵	Voltage
<input type="checkbox"/> M Marine Type UL 1598A Floodlight ¹ Metal Halide ² <input type="checkbox"/> FM-1000 <input type="checkbox"/> FM-1500 Pulse Start Metal Halide ³ <input type="checkbox"/> FP-250 <input type="checkbox"/> FP-350 <input type="checkbox"/> FP-400 <input type="checkbox"/> FP-1000 <small>Standard unit with BT37 lamp uses 23" housing. HAZ unit requires 26" housing.</small> High Pressure Sodium <input type="checkbox"/> FS-400 <input type="checkbox"/> FS-1000 ⁴	<input type="checkbox"/> A Specular Reflector Wide  <input type="checkbox"/> B Specular Reflector Medium  <input type="checkbox"/> C Diffused Reflector Very Wide  <input type="checkbox"/> D Diffused Reflector Wide 	<input type="checkbox"/> 120 <input type="checkbox"/> 208 <input type="checkbox"/> 240 <input type="checkbox"/> 277 <input type="checkbox"/> 347 <input type="checkbox"/> 480 <input type="checkbox"/> QV ⁶



Options (Factory Installed)	Finish	Accessories (Ordered Separately)	
<input type="checkbox"/> BL ⁷ Bi-Level <input type="checkbox"/> LQ Hot/Cold Quartz Restrike <input type="checkbox"/> LQ40 Hot/Cold Quartz Restrike for Cold Weather starts to -40°C (-40°F) <input type="checkbox"/> F-F1 ⁸ Single Fuse (120/277V) <input type="checkbox"/> F-F2 ⁸ Double Fuse (208/240/480V) <input type="checkbox"/> LB ⁹ Less Ballast (remote mount ballast) <input type="checkbox"/> CO ¹⁰ Cutoff optics <input type="checkbox"/> HAZ ¹¹ Hazardous Location listed <input type="checkbox"/> 50HZ 50 Hz Ballast operation (consult factory) <input type="checkbox"/> TG Teflon bonded to glass lens <input type="checkbox"/> PB(X) Pre-wired ballast (X) = SO cord length in feet: 3, 6 or 10 <input type="checkbox"/> EPXY-CTD-WHT White Epoxy coated <input type="checkbox"/> EPXY-CTD-GR Gray Epoxy coated	<input type="checkbox"/> TGR Textured Gray <input type="checkbox"/> TBK Textured Black <input type="checkbox"/> TDB Textured Dark Bronze <input type="checkbox"/> TSA Textured Satin Aluminum <input type="checkbox"/> TWHT Textured White <input type="checkbox"/> TGN Textured Green <input type="checkbox"/> M(F) Marine Grade finish; Two-part epoxy primer and a polyurethane top coat especially suited for marine environments and coastal applications. (F) = Specify color. Example: MWHT = Marine Grade White finish Consult factory for color availability.	<input type="checkbox"/> F-F1-KIT-(F) Single Fuse Kit (120/277/347V) <input type="checkbox"/> F-F2-KIT-(F) Double Fuse Kit (208/240/480V) <input type="checkbox"/> MF-1-(F) ⁹ Mastfitter <input type="checkbox"/> TH-1-(F) ⁹ Lowering Adapter (Tenon Hanger) <input type="checkbox"/> HV-1-(F) ⁹ Trunion Base <input type="checkbox"/> WB-1-(F) Wall Bracket <input type="checkbox"/> WB-5-(F) Wiring Box (used with WB-1 & surface mounted conduit feed) <input type="checkbox"/> PX-1-(F) Cross-Arm Bracket <input type="checkbox"/> AL-4-F Auxiliary Polymer Lens (23" housing) <input type="checkbox"/> AL-10-F Auxiliary Polymer Lens (26" housing) <input type="checkbox"/> ALF-4-F-L/LENS-(F) Auxiliary Lens Frame (23" housing) <input type="checkbox"/> ALF-10-F-L/LENS-(F) Auxiliary Lens Frame (26" housing) <input type="checkbox"/> ALF-10-F-L/GLASS-LV8-(F) 26" Lens Frame with louver; <input type="checkbox"/> LENS-ALF-F-4-GLASS-(color) Colored Lens (23" housing); (color) = lens color <input type="checkbox"/> LENS-ALF-F-10-GLASS-(color) Colored Lens (26" housing); (color) = lens color <input type="checkbox"/> PM-1 Wood Pole Mounting Kit (with one U-arm) <input type="checkbox"/> PM-2 Wood Pole Mounting Kit (with two U-arms) <input type="checkbox"/> PM-3 Wood Pole Mounting Kit (with three U-arms) <input type="checkbox"/> PM-4 Wood Pole Mounting Kit (with four U-arms)	<input type="checkbox"/> SMB-400 ⁹ Shock Mounting Bracket (23" housing) <input type="checkbox"/> SMB-1000 ⁹ Shock Mounting Bracket (26" housing) <input type="checkbox"/> FB-1 Flat Base Mount <input type="checkbox"/> PCM-1 Photocell Receptacle Mounting Bracket <input type="checkbox"/> SK-40-(F) Cutoff Shield (23" housing) <input type="checkbox"/> SK-100-(F) Cutoff Shield (26" housing)

- 1) "M" prefix along with series designates UL 1598A Marine Listed option which includes additional Marine Grade gasketing. Unit is specially constructed with low copper content alloy (less than 0.4%) for corrosion control in harsh coastal and industrial environments or wherever marine type units are required. Meets U.S. Coast Guard specifications for marine type applications.
- 2) Wattages listed assume the use of clear lamps. Coated lamps also available for 1000W metal halide.
- 3) For acceptable performance, note position orientation specific nature of Pulse Start Lamps. Operation of Pulse Start lamps in other than recommended burning positions may result in significantly reduced performance. Consult factory to determine if a suitable Pulse Start Lamp is available for the intended application.
- 4) In 1000W HPS units, the standard SO cord from ballast to optic head is replaced with flex conduit. Less ballast options and accessories are not available.
- 5) A and B reflectors are of Specular Miro 4 aluminum; C and D reflectors are of Hammertone Miro 9 aluminum. Curves reflect coated lamp performance.
- 6) Allows field selection of 120/208/240/277V. (No 480V). Certain options may require voltage selection as well.
- 7) Suitable for HPS in any aiming position.
- 8) Fusing not available on MF series (marine listed) units.
- 9) Remote mount ballasts options and accessories are not available with 1000W HPS or on MF series (marine listed) units.
- 10) Available with B and D reflectors only.
- 11) HAZ listing available in the US on MF units only, 400W and 1000W only. HAZ listing not available in Canada

F Series (available MF Series: Marine Listed with optional hazardous location listing)

Industrial Floodlight - 250-1500 watt HID

Type:	Job:	Page 3 of 6
-------	------	-------------

Beam Spread Data

Reflector Type	Source	Wattage	Max Candle Power	H x V NEMA	Horizontal X Vertical	
					10% Field Angle	50% Beam Angle
A Specular Wide	MH coated	1000W	43,000	7 x 7	147° x 140°	90° x 49°
		1500W	351,000	3 x 4	38° x 62°	14° x 34°
B Specular Medium	MH clear	1000W	249,000	3 x 4	38° x 62°	14° x 34°
		1500W	351,000	3 x 4	38° x 62°	14° x 34°
	MH coated	1000W	79,000	6 x 7	127° x 133°	36° x 44°
		PS clear	250W	52,000	3 x 4	38° x 62°
	PS clear	400W	90,000	3 x 4	38° x 62°	14° x 34°
		1000W	260,000	3 x 4	38° x 62°	14° x 34°
		HPS clear	400W	117,000	3 x 4	39° x 53°
	HPS clear	1000W	236,000	5 x 5	88° x 87°	13° x 41°
C Diffused Very Wide		MH clear	1000W	58,000	7 x 6	137° x 129°
	1500W		82,000	7 x 6	137° x 129°	83° x 37°
	MH coated	1000W	37,000	7 x 7	150° x 144°	93° x 55°
		PS clear	250W	52,000	7 x 6	137° x 129°
	PS clear	400W	90,000	7 x 6	137° x 129°	83° x 37°
		1000W	260,000	7 x 6	137° x 129°	83° x 37°
HPS clear	400W	26,000	7 x 6	137° x 125°	105° x 35°	
	1000W	50,000	7 x 7	138° x 135°	85° x 58°	
D Diffused Wide	MH clear	1000W	133,000	5 x 5	93° x 76°	28° x 36°
		1500W	187,000	5 x 5	93° x 76°	28° x 36°
	MH coated	1000W	37,000	7 x 7	150° x 144°	93° x 55°
		PS clear	250W	52,000	5 x 5	93° x 76°
	PS clear	400W	90,000	5 x 5	93° x 76°	28° x 36°
		1000W	260,000	5 x 5	93° x 76°	28° x 36°
		HPS clear	400W	26,000	7 x 6	137° x 125°
	HPS clear	1000W	50,000	7 x 7	138° x 135°	85° x 58°

Distribution Guide & Ballast Data^{1,4,5}

Source Type ⁽¹⁾	Catalog Number	Reflector Type	Lamp Envelope	.ies File Name	ANSI Code	Line Current 120 / 208 / 240 / 277 / 480	Line Watts
MH Clear Lamps	FM-1000	B	BT56	fm100bss.ies	M47 / H36	9.2 / 5.6 / 4.7 / 4.1 / 2.4	1080
	FM-1000	C	BT56	fm100css.ies	M47 / H36	9.2 / 5.6 / 4.7 / 4.1 / 2.4	1080
	FM-1000	D	BT56	fm100dss.ies	M47 / H36	9.2 / 5.6 / 4.7 / 4.1 / 2.4	1080
	FM-1500	B	BT56	fm150bss.ies	M48	14.0 / 8.0 / 7.1 / 6.1 / 3.5	1625
	FM-1500	C	BT56	fm150css.ies	M48	14.0 / 8.0 / 7.1 / 6.1 / 3.5	1625
	FM-1500	D	BT56	fm150dss.ies	M48	14.0 / 8.0 / 7.1 / 6.1 / 3.5	1625
MH Coated Lamps	FM-1000	A	BT56	fmc10ass.ies	M47 / H36	9.2 / 5.6 / 4.7 / 4.1 / 2.4	1080
	FM-1000	B	BT56	fmc10bss.ies	M47 / H36	9.2 / 5.6 / 4.7 / 4.1 / 2.4	1080
	FM-1000	C	BT56	fmc10css.ies	M47 / H36	9.2 / 5.6 / 4.7 / 4.1 / 2.4	1080
	FM-1000	D	BT56	fmc10dss.ies	M47 / H36	9.2 / 5.6 / 4.7 / 4.1 / 2.4	1080
PS Clear Lamps	FP-400	B	BT37	fp40bss.ies	M135 / M155	4.0 / 2.2 / 1.9 / 1.8 / 1.0	456
	FP-400	C	BT37	fp40css.ies	M135 / M155	4.0 / 2.2 / 1.9 / 1.8 / 1.0	456
	FP-400	D	BT37	fp40dss.ies	M135 / M155	4.0 / 2.2 / 1.9 / 1.8 / 1.0	456
	FP-1000	B	BT37	fp100bss.ies	M141	9.0 / 5.2 / 4.5 / 3.9 / 2.4	1080
	FP-1000	C	BT37	fp100css.ies	M141	9.0 / 5.2 / 4.5 / 3.9 / 2.4	1080
	FP-1000	D	BT37	fp100dss.ies	M141	9.0 / 5.2 / 4.5 / 3.9 / 2.4	1080
HPS Clear Lamps	FS-400	B	ED18	fs40bss.ies	S51	4.1 / 2.5 / 2.1 / 1.9 / 1.1	467
	FS-400	C	ED18	fs40css.ies	S51	4.1 / 2.5 / 2.1 / 1.9 / 1.1	467
	FS-400	D	ED18	fs40dss.ies	S51	4.1 / 2.5 / 2.1 / 1.9 / 1.1	467
	FS-1000	B	E25	fs100bss.ies	S52	9.5 / 5.5 / 4.8 / 4.2 / 2.5	1100
	FS-1000	C	E25	fs100css.ies	S52	9.5 / 5.5 / 4.8 / 4.2 / 2.5	1100
	FS-1000	D	E25	fs100dss.ies	S52	9.5 / 5.5 / 4.8 / 4.2 / 2.5	1100

1) The F Series can accommodate a variety of other wattages and lamps. Consult factory.

2) MH = Metal Halide, PS = Pulse Start Metal Halide, HPS = High Pressure Sodium.

3) All ballasts are CWA (Constant Wattage Autotransformer).

4) LER values and efficiencies are not published. See NEMA Standard LE-5B.

5) Intended aiming and possible lamp orientation restrictions should be considered when selecting floodlight.

EPA	Effective Projected Area in Ft ²
23" housing	1.85
26" housing	2.93

F Series (available MF Series: Marine Listed with optional hazardous location listing)

Industrial Floodlight - 250-1500 watt HID

Type:	Job:	Page 4 of 6
--------------	-------------	-------------

Option Details (Factory Installed)

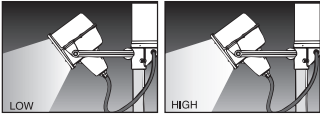
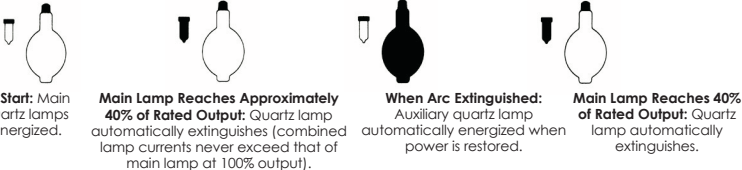
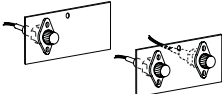
BL	Bi-Level <i>Note:</i> Suitable for HPS in any aiming position. Consult factory when specifying dimming with Metal Halide.	Bi-Level provides high / low level of lamp output with up to 50% power consumption. Zero cross-over network avoids strobing and lamp dropout.																										
LQ	Hot/Cold Quartz Restrike <i>Note:</i> Standard 150 watt (120V) double contact bayonet base socket. Combined Quartz wattage may not exceed HID lamp wattage.	LQ - Provides LiteMatic operation for fixtures with 120V or multi-tap ballasts. LiteMatic Operation																										
LQ40	Hot/Cold Quartz Restrike for Cold Weather Starts to -40°C (-40°F)																											
F-F1	Single Fuse (120V/277V)	Fuses are KTK/CLK 30 amp unless otherwise specified.																										
F-F2	Double Fuse (208V/240V/480V) <i>Note:</i> Fusing not available on MF series (marine listed) units. If ordering QV ballast, voltage must be specified.																											
LB	Less Ballast (remote mount ballast) <i>Note:</i> Remote mount ballast options and accessories are not available with 1000W HPS or on MF series (marine listed) units.	Optic unit with mounting arms shipped without standard integral mastfitter and ballast assembly. Requires mounting accessory MF-1, TH-1, HV-1, SMB-400 or SMB-1000 (shipped separately).																										
CO	Cutoff Optics <i>Note:</i> Available with B and D reflectors only.	For applications where glare control is needed. Requires use of proper cutoff shield accessory: SK-40-(F) or SK-100-(F) (shipped separately).																										
HAZ	Hazardous Location Listed Limited to 400W and 1000W units only. Available on MF (marine listed) units only. (See Listing on page 1.) Class I, Division 2, Groups A, B, C and D.	Class I Division 2, Groups A, B, C, D																										
		<table border="1" style="width: 100%; border-collapse: collapse;"> <thead> <tr> <th style="text-align: left;">Catalog No.</th> <th style="text-align: center;">Measured Max. Internal Operating Temperature</th> <th style="text-align: center;">Measured Max. External Operating Temperature</th> <th style="text-align: center;">T Rating</th> </tr> </thead> <tbody> <tr> <td>MFM-1000</td> <td style="text-align: center;">339°C</td> <td style="text-align: center;">163°C</td> <td style="text-align: center;">T1</td> </tr> <tr> <td>MFP-400</td> <td style="text-align: center;">316°C</td> <td style="text-align: center;">131°C</td> <td style="text-align: center;">T1</td> </tr> <tr> <td>MFP-1000*</td> <td style="text-align: center;">339°C</td> <td style="text-align: center;">163°C</td> <td style="text-align: center;">T1</td> </tr> <tr> <td>MFS-400</td> <td style="text-align: center;">374°C</td> <td style="text-align: center;">110°C</td> <td style="text-align: center;">T1</td> </tr> <tr> <td>MFS-1000</td> <td style="text-align: center;">373°C</td> <td style="text-align: center;">123°C</td> <td style="text-align: center;">T1</td> </tr> </tbody> </table>	Catalog No.	Measured Max. Internal Operating Temperature	Measured Max. External Operating Temperature	T Rating	MFM-1000	339°C	163°C	T1	MFP-400	316°C	131°C	T1	MFP-1000*	339°C	163°C	T1	MFS-400	374°C	110°C	T1	MFS-1000	373°C	123°C	T1		
Catalog No.	Measured Max. Internal Operating Temperature	Measured Max. External Operating Temperature	T Rating																									
MFM-1000	339°C	163°C	T1																									
MFP-400	316°C	131°C	T1																									
MFP-1000*	339°C	163°C	T1																									
MFS-400	374°C	110°C	T1																									
MFS-1000	373°C	123°C	T1																									
		* Thermal limits require 26" housing for MF Series 1000W PS unit with UL 844 listed HAZ option rating. Data supplied by Texas Research Institute, Inc., corrected to 23°C. Note: The classification of an area as to class, division and groups and the use of UL 844 listed luminaires in such areas is solely the judgement of the owner, insurance carrier and the authority having jurisdiction.																										
50HZ	50 Hz Ballast Operation (consult factory)	Specified for applications (outside the U.S.) where 50 Hertz operation is standard.																										
TG	Teflon Bonded to Glass Lens	5 MIL Teflon® bonded to standard glass lens.																										
PB(X)	Pre-wired ballast, specify length of SO cord in ft: (X = 3, 6 or 10)	Allows wiring connections to be made in remote mounted junction box. Useful with various mounting accessories such as WB1 wall bracket.																										
EPXY-CTD-WHT	White Epoxy Coated	Durable coating offers protection against mildly acidic or alkaline conditions.																										
EPXY-CTD-GR	Gray Epoxy Coated																											

Accessory Details (Field Installed - Shipped Separately)

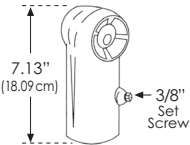
F-F1-KIT -(F)	Single Fuse Kit (120V/277V)	Consists of 1 or 2 fuse holders and 1 or 2 KTK 30 amp fuses. Field installed on wiring access plate. Fusing not available with MF series (marine listed) units. (F) = specify finish	
F-F2-KIT -(F)	Double Fuse Kit (208V/240V/480V)		
MF-1-(F)	Mastfitter <i>Note:</i> Remote mount ballast options and accessories are not available with 1000W HPS or on MF series (marine listed) units.	Cast aluminum mastfitter for 2-3/8" O.D. pipe tenon. For use with remote mounted ballast on all F Series models. (Requires a vertical tenon height of 4-5/8" minimum) (F) = specify finish	

F Series (available MF Series: Marine Listed with optional hazardous location listing)

Industrial Floodlight - 250-1500 watt HID

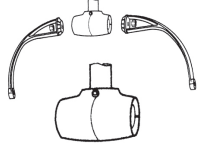
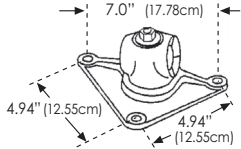
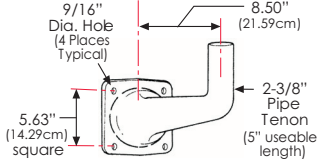
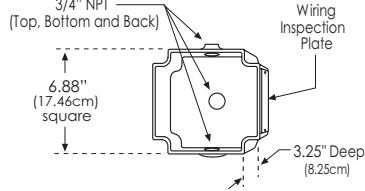
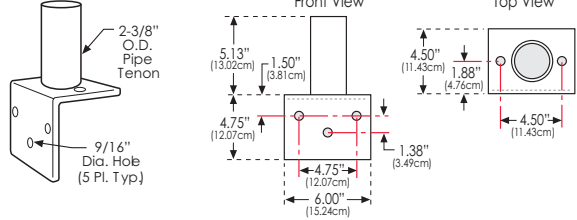
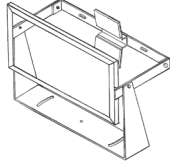
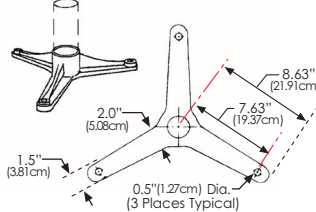
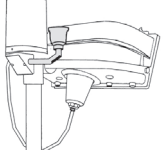
Type:	Job:	Page 5 of 6
TH-1-(F) Note: Remote mount ballast options and accessories are not available with 1000W HPS or on MF series (marine listed) units. (F) = specify finish	Lowering Adapter (Tenon Hanger) Cast aluminum hanger tapped for 1-1/4" NPT conduit or pipe. Equips floodlights with remote mounted ballasts for use on standard lowering devices. Mounting arms provided with fixture. <i>(Requires a vertical tenon length of 4-5/8" minimum)</i>	
HV-1-(F) Note: Remote mount ballast options and accessories are not available with 1000W HPS or on MF series (marine listed) units. (F) = specify finish	Trunion Base Cast aluminum trunion base bracket calibrated for horizontal adjustment. For use with remote mounted ballast.	
WB-1-(F) (F) = specify finish	Wall Bracket Cast aluminum wall bracket for vertical surfaces only. Designed to permit mounting of floodlights on flat vertical surfaces. Use in conjunction with WB-5 for surface mounted wiring.	
WB-5-(F) (F) = specify finish	Wiring Box for WB-1 and surface mounted conduit feed Used in conjunction with WB1 for surface mounted wiring. Tapped top, back and bottom for 3/4" conduit or pipe. Gasket provided for sealing surface wiring box to WB-1 (wall mounting bracket).	
PX-1-(F) (F) = specify finish	Cross-arm Bracket For installing floodlights on wooden or steel cross-arms. "L" base.	
SMB-400 SMB-1000	Shock Mounting Bracket (23" housing) Shock Mounting Bracket (26" housing)	Shock Mounting Bracket for use in applications where severe vibration may be present. Secures floodlight with a remote mounted ballast less mounting arms or mastfitter. Constructed of hot-dip galvanized steel with neoprene pads to absorb shock. Corrosion resistant assembly hardware is furnished. <i>Note: Not available with 1000W HPS or on MF series (marine listed) units.</i> 
FB-1	Flat Base Mount Cast aluminum mounting bracket for installing floodlights on flat horizontal surfaces. For use with 2-3/8" OD pipe tenon (by others). Limit tenon height to 8.0" (20.32cm).	
PCM-1	Photocell Receptacle Mounting Bracket Bracket with standard twist-lock receptacle for models with integral ballasts. Threads into 1/2" NPT hole in ballast base or mastfitter. (Photocell not included.)	

F Series (available MF Series: Marine Listed with optional hazardous location listing)

Industrial Floodlight - 250-1500 watt HID

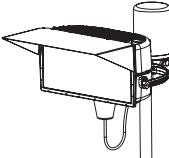
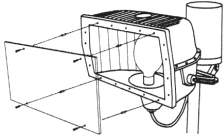
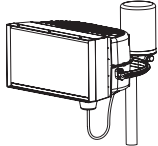
Type:	Job:		Page 6 of 6
SK-40-(F) SK-100-(F)	Cutoff Shield for 23" housing Cutoff Shield for 26" housing	Cutoff shield provides precise vertical cutoff without distortion of lateral pattern. (F) = Specify finish.	
AL-4-F AL-10-F	Auxiliary Polymer Lens for 23" housing Auxiliary Polymer Lens for 26" housing	1/4" thick impact-resistant polymer lens provides additional protection of the glass lens. Furnished with mounting hardware and standoffs.	
AL-4-F-L/LENS-(F) AL-10-F-L/LENS-(F)	Auxiliary Lens Frame for 23" housing Auxiliary Lens Frame for 26" housing	Designed for use with colored lenses. Formed aluminum frame isolates the auxiliary lens from heat source for longer life. Gasketed to minimize particulate and moisture entry. May be used as a snoot when installed without a lens. Mounting hardware included. (F) = Specify finish.	
ALF-10-F-L/GLASS-LV8-(F)	Auxiliary Lens Frame with 8-lite internal louver	For additional narrow beam glare control, specify the auxiliary lens frame with the 8-lite internal louver. Available for 26" housing only. (F) = Specify finish.	
LENS-ALF-F-4-GLASS-(color) LENS-ALF-F-10-GLASS-(color)	Colored Auxiliary Lens for 23" housing Colored Auxiliary Lens for 26" housing	Colored auxiliary lens (fully tempered glass). Requires the use of the auxiliary lens frame. (color) = Lens color. (Consult factory to specify color of glass lens.) Note: Colored lens reduces efficiency.	

- PM-1** Wood Pole Mounting Kit with one U-arm
Shipping wt.: 6 lbs (2.7 kg)
- PM-2** Wood Pole Mounting Kit with two U-arms
Shipping wt.: 9 lbs (4.05 kg)
- PM-3** Wood Pole Mounting Kit with three U-arms
Shipping wt.: 12 lbs (5.4 kg)
- PM-4** Wood Pole Mounting Kit with four U-arms
Shipping wt.: 15 lbs (6.8 kg)

For mounting luminaires with mastfitters to 6.0" to 12.0" O.D. wood poles.

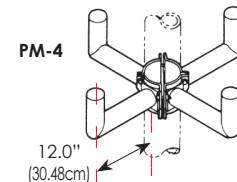
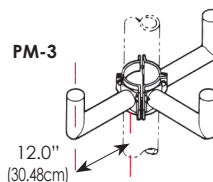
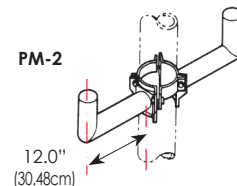
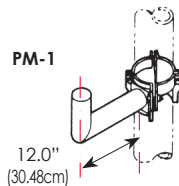

Notes



© 2013 Koninklijke Philips N.V. All rights reserved.
Specifications are subject to change without notice.
www.philips.com/luminaires

G200-116/0614

Philips Lighting
North America Corporation
200 Franklin Square Drive
Somerset, NJ 08873
Phone: 855-486-2216

Imported by: Philips Lighting,
a division of Philips Electronics Ltd.
281 Hillmount Rd,
Markham, ON L6C 2S3
Tel. 800-668-9008