

Areamaster™ 250/400 Integrally Ballasted Floodlights

70 W, 100 W, 150 W, 250 W, 400 W HPS; 175 W, 200 W, 250 W, 320 W, 400 W PSMH.

175 W, 250 W, 400 W MH 

NEC: For general, marine and hazardous locations
Class I, Division 2, Groups A, B, C, D
Class I, Zone 2, AEx nR, Groups IIA, IIB, IIC

CEC  For general, marine and hazardous locations
Class I, Division 2, Groups A, B, C, D
Class I, Zone 2, Ex nR, Groups IIA, IIB, IIC
Class II, Division 1 and 2, Groups E, F, G
Class III

NEC/CEC:
IP66
Marine type electric fixtures, outside type (salt water)

Applications

- Powerful, efficient weatherproof lighting for medium and large areas such as:
 - Shopping malls
 - Parking lots
 - Sports areas
 - New-car lot lighting
 - Security lighting
 - Industrial process lighting

Features

- Compact in size, attractively styled contemporary design, rugged and dependable.
- Easy to install and service.
- A wide range of ballasts and voltages are available for both domestic and export applications.
- Integral ballast.
- One-piece housing.
- One-piece lens cover. Secured by four 1/4" Dia. captive stainless steel slotted hex-head bolts.
- Thermal shock and impact resistant glass lens.
- Heavy duty, high temperature silicone rubber gasket, firmly seated.
- Heavy duty mogul-base porcelain socket with heavy gauge brass, nickel-plated, double lamp-grip screw shell and spring-loaded center contact.
- Compound parabolic, double segment, finished aluminum reflector for optimum efficiency.
- Mounting choice:
 - (1) Yoke mount, zinc plated steel yoke with architectural bronze polyester finish
 - (2) Pole mount, built-in slip-fitter, for internal wiring, adjustable laterally and vertically, slip fits 2" or 2-1/2" pipe, architectural bronze polyester finish
- Cool operating temperatures translate into long luminaire life.

Standard Materials

- Ballast housing and lens door: copperfree (4/10 of 1% max.) aluminum
- Gasket: silicone rubber
- Socket: heavy duty porcelain with heavy gauge brass shell
- Reflector: finished aluminum
- Yoke mount: zinc plated steel
- Bolts: stainless steel

Standard Finishes

- Ballast housing, lens cover, yoke and pole mount: architectural bronze polyester
- Socket: nickel-plated

Certifications and Compliances

- Areamaster 250/400
 - UL Standard: UL 1598, UL 1598A, UL 844
 - UL Listed: E10794
- Zone 2 Areamaster 250/400
 - UL Standard: UL 1598, UL 1598A, UL 60079-0, UL 60079-15
 - UL Listed: E10794



Projected Area: 1.9 Sq. Ft.

Dimensions in Inches/Millimeters

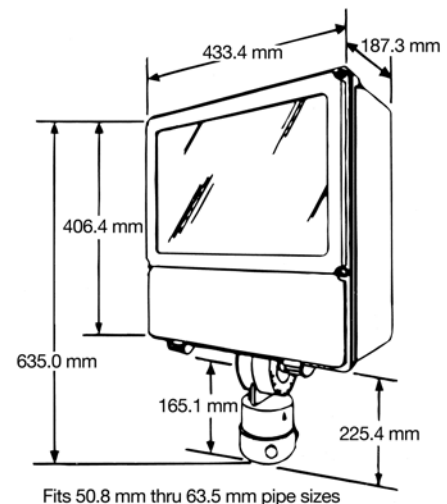

 CSA Certification only.

Visit our website at www.appletonelec.com or contact us at (800) 621-1506.
© September 2010

 **Appleton**

1155

LIGHTING: ENCLOSED AND GASKETED — FLOODLIGHT

Lighting

Areamaster™ 250/400 Integrally Ballasted Floodlights

70 W, 100 W, 150 W, 250 W, 400 W HPS; 175 W, 200 W, 250 W, 320 W, 400 W PSMH.

175 W, 250 W, 400 W MH 

NEC: For general, marine and hazardous locations
Class I, Division 2, Groups A, B, C, D
Class I, Zone 2, AEx nR, Groups IIA, IIB, IIC

CEC : For general, marine and hazardous locations
Class I, Division 2, Groups A, B, C, D
Class I, Zone 2, Ex nR, Groups IIA, IIB, IIC
Class II, Division 1 and 2, Groups E, F, G
Class III

NEC/CEC:
IP66
Marine type electric fixtures, outside type (salt water)

"T" Numbers

Watts	Lamp Type	Supply Wire Temp. (°F/°C)	Ambient Temp. (°F/°C)	NEC/CEC	CEC 	NEC/CEC
				Class I, Division 2, Groups A, B, C, D	Class II, Division 1 and 2, Groups E, F, G	Class I, Zone 2
70	HPS	140/60	104/40	T3C	T3B	T6
		167/75	131/55	T3B	—	T5
		194/90	149/65	T3A	—	T4
100	HPS	167/75	104/40	T3	T3B	T5
		194/90	131/55	T2D	—	T4
		221/105	149/65	T2C	—	T4
150	HPS	185/85	104/40	T2C	T3B	T4
		221/105	131/55	T2B	—	T4
		230/110	149/65	T2B	—	T3
250	HPS	167/75	104/40	350	T3B	T4
		194/90	131/55	350	—	T3
		221/105	149/65	T1	—	T3
400	HPS	221/105	104/40	T1	T3B	T3
		257/125	122/50	—	—	T3
175	PSMH	194/90	104/40	T2	T3B	T4
		221/105	131/55	325	—	T3
200	PSMH	230/110	149/65	325	—	T3
		167/75	104/40	325	T3B	T3
		185/85	131/55	325	—	T3
250	PSMH	221/105	149/65	325	—	T3
		185/85	104/40	325	T3B	T3
		221/105	131/55	325	—	T3
320	PSMH	230/110	149/65	—	—	T3
		185/85	104/40	325	T3B	T3
		221/105	131/55	325	—	T3
400	PSMH	221/105	104/40	325	T3B	T3
		239/115	131/55	325	—	T3

"T" Numbers Represent the Maximum Lamp Temperature for Class I, Division 2 Locations and Maximum Surface Temperature Under Dust Blanket for Class II, Division 1 Locations.

"T" Number	T1	350	325	T2	T2A	T2B	T2C	T2D	T3	T3A	T3B	T3C	T4	T4A	T5	T6
Temp. Range (°F)	664-842	619-662	574-617	538-572	502-536	448-500	421-446	394-419	358-392	331-356	322-329	277-320	250-275	214-248	187-212	185
Temp. Range (°C)	351-450	326-350	301-325	281-300	261-280	231-260	216-230	201-215	181-200	166-180	161-165	136-160	121-135	101-120	86-100	85

"T" Numbers Represent the Maximum Surface Temperature for Luminaries with AEx nA nR or AEx nR rating

"T" Number	T1	T2	T3	T4	T5	T6
Temp. Range (°F)	547-842	394-572	277-392	214-275	187-212	185
Temp. Range (°C)	301-450	201-300	136-200	101-135	86-100	85

 CSA Certification only.

Areamaster™ 250/400 Integrally Ballasted Floodlights

70 W, 100 W, 150 W, 250 W, 400 W HPS; 175 W, 200 W, 250 W, 320 W, 400 W PSMH

NEC: For general, marine and hazardous locations
Class I, Division 2, Groups A, B, C, D
Class I, Zone 2, AEx nR, Groups IIA, IIB, IIC
IP66

Marine type electric fixtures, outside type
(salt water)

Lamp	Line Voltage	For Class 1, Division 2 Classified Duty and Marine Yoke Mount	For General Duty		Class I, Zone 2 Yoke Mounting
		Catalog Number ②③	Yoke Mount Catalog Number ②	Slip-Fit Mount Catalog Number ①②	Catalog Number ③
High Pressure Sodium					
70 W HPS ④	120/208/240/277	G-AML271L-MT-I/2	—	—	G-AML271L-MT-Z2
	220 V 50 Hz	G-AML271L-225-I/2 ⑤	—	—	G-AML271L-225-Z2 ⑤
	480	G-AML271L-48-I/2	—	—	G-AML271L-48-Z2
100 W HPS ④	120/208/240/277	G-AML371L-MT-I/2	—	—	G-AML371L-MT-Z2
	220 V 50 Hz	G-AML371L-225-I/2 ⑤	—	—	G-AML371L-225-Z2 ⑤
	480	G-AML371L-48-I/2	—	—	G-AML371L-48-Z2
150 W HPS ④	120/208/240/277	G-AML471L-MT-I/2	—	—	G-AML471L-MT-Z2
	220 V 50 Hz	G-AML471L-225-I/2 ⑤	—	—	G-AML471L-225-Z2 ⑤
	480	G-AML471L-48-I/2	—	—	G-AML471L-48-Z2
250 W HPS	120/208/240/277	G-AM671L-MT-I/2	G-AM671L-MT	G-AM675L-MT	G-AM671L-MT-Z2
	230 V 50 Hz	G-AM671L-235-I/2 ⑥	G-AM671L-235 ⑥	G-AM675L-235 ⑥	G-AM671L-235-Z2 ⑥
	480	G-AM671L-48-I/2	G-AM671L-48	G-AM675L-48	G-AM671L-48-Z2
400 W HPS	120/208/240/277	G-AM771L-MT-I/2	G-AM771L-MT	G-AM775L-MT	G-AM771L-MT-Z2
	230 V 50 Hz	G-AM771L-235-I/2 ⑥	G-AM771L-235 ⑥	G-AM775L-235 ⑥	G-AM771L-235-Z2 ⑥
	480	G-AM771L-48-I/2	G-AM771L-48	G-AM775L-48	G-AM771L-48-Z2
Pulse Start Metal Halide					
175 W PSMH	120/208/240/277	G-AM571P-MT-I/2	G-AM571P-MT	G-AM575P-MT	G-AM571P-MT-Z2
	480	G-AM571P-48-I/2	G-AM571P-48	G-AM575P-48	G-AM571P-48-Z2
200 W PSMH	120/208/240/277	G-AM2071P-MT-I/2	G-AM2071P-MT	G-AM2075P-MT	G-AM2071P-MT-Z2
	480	G-AM2071P-48-I/2	G-AM2071P-48	G-AM2075P-48	G-AM2071P-48-Z2
250 W PSMH	120/208/240/277	G-AM671P-MT-I/2	G-AM671P-MT	G-AM675P-MT	G-AM671P-MT-Z2
	230 V 50 Hz	G-AM671P-235-I/2 ⑥	G-AM671P-235 ⑥	G-AM675P-235 ⑥	G-AM671P-235-Z2 ⑥
	480	G-AM671P-48-I/2	G-AM671P-48	G-AM675P-48	G-AM671P-48-Z2
320 W PSMH	120/208/240/277	G-AM3271P-MT-I/2	G-AM3271P-MT	G-AM3275P-MT	G-AM3271P-MT-Z2
	230 V 50 Hz	G-AM3271P-235-I/2 ⑥	G-AM3271P-235 ⑥	G-AM3275P-235 ⑥	G-AM3271P-235-Z2 ⑥
	480	G-AM3271P-48-I/2	G-AM3271P-48	G-AM3275P-48	G-AM3271P-48-Z2
400 W PSMH	120/208/240/277	G-AM771P-MT-I/2	G-AM771P-MT	G-AM775P-MT	G-AM771P-MT-Z2
	230 V 50 Hz	G-AM771P-235-I/2 ⑥	G-AM771P-235 ⑥	G-AM775P-235 ⑥	G-AM771P-235-Z2 ⑥
	480	G-AM771P-48-I/2	G-AM771P-48	G-AM775P-48	G-AM771P-48-Z2

① Slip-fits 2" or 2-1/2" pipe-size tenons.

② Add suffix -E to catalog number if provision for quartz emergency option is desired. Furnished with socket installed and pre-wired.

③ Quartz emergency option NOT available for Class I, Division 2 or Class I, Zone 2 fixtures. Classified duty floodlights have 1/2" N.P.T tapped hub for power entry. Use 221 °F/105 °C supply wire.

④ For Hot Restrike Option, add suffix -R.

⑤ For 120 V 50 Hz change -225 to -125, or for 240 V 50 Hz change -225 to -245.

⑥ For 120 V 50 Hz change -235 to -125.

Areamaster™ 250/400 Integrally Ballasted Floodlights

70 W, 100 W, 150 W, 250 W, 400 W HPS; 175 W, 200 W, 250 W, 320 W, 400 W PSMH;
175 W, 250 W, 400 W MH

CEC ¹: For general, marine and hazardous locations

Class I, Division 2, Groups A, B, C, D
Class I, Zone 2, Ex nR, Groups IIA, IIB, IIC
Class II, Division 1 and 2, Groups E, F, G
Class III

IP66

Marine type electric fixtures, outside type (salt water)

Lamp	Line Voltage	For Class 1, Division 2 Classified Duty and Marine Yoke Mount Catalog Number ②⑥		For General Duty		Class I, Zone 2 Yoke Mounting Catalog Number ⑥
		Yoke Mount Catalog Number ②	Slip-Fit Mount Catalog Number ①②	Yoke Mount Catalog Number ②	Slip-Fit Mount Catalog Number ①②	
High Pressure Sodium						
70 W HPS ④	120/277/347	G-AML271L-TT-I/2	—	—	—	G-AML271L-TT-Z2
	220 V 50 Hz	G-AML271L-225-I/2 ⑥	—	—	—	G-AML271L-225-Z2 ⑥
	600 ⑦	G-AML271L-C7-I/2	—	—	—	G-AML271L-C7-Z2
100 W HPS ④	120/277/347	G-AML371L-TT-I/2	—	—	—	G-AML371L-TT-Z2
	220 V 50 Hz	G-AML371L-225-I/2 ⑥	—	—	—	G-AML371L-225-Z2 ⑥
	600 ⑦	G-AML371L-C7-I/2	—	—	—	G-AML371L-C7-Z2
150 W HPS ④	120/277/347	G-AML471L-TT-I/2	—	—	—	G-AML471L-TT-Z2
	220 V 50 Hz	G-AML471L-225-I/2 ⑥	—	—	—	G-AML471L-225-Z2 ⑥
	600 ⑦	G-AML471L-C7-I/2	—	—	—	G-AML471L-C7-Z2
250 W HPS	120/277/347	G-AM671L-TT-I/2	G-AM671L-TT	G-AM675L-TT	—	G-AM671L-TT-Z2
	230 V 50 Hz	G-AM671L-235-I/2 ⑥	G-AM671L-235 ⑥	G-AM675L-235 ⑥	—	G-AM671L-235-Z2 ⑥
	600 ⑦	G-AM671L-C7-I/2	G-AM671L-C7	G-AM675L-C7	—	G-AM671L-C7-Z2
400 W HPS	120/277/347	G-AM771L-TT-I/2	G-AM771L-TT	G-AM775L-TT	—	G-AM771L-TT-Z2
	230 V 50 Hz	G-AM771L-235-I/2 ⑥	G-AM771L-235 ⑥	G-AM775L-235 ⑥	—	G-AM771L-235-Z2 ⑥
	600 ⑦	G-AM771L-C7-I/2	G-AM771L-C7	G-AM775L-C7	—	G-AM771L-C7-Z2
Pulse Start Metal Halide						
175 W PSMH	120/277/347	G-AM571P-TT-I/2	G-AM571P-TT	G-AM575P-TT	—	G-AM571P-TT-Z2
200 W PSMH	120/277/347	G-AM2071P-TT-I/2	G-AM2071P-TT	G-AM2075P-TT	—	G-AM2071P-TT-Z2
250 W PSMH	120/277/347	G-AM671P-TT-I/2	G-AM671P-TT	G-AM675P-TT	—	G-AM671P-TT-Z2
	230 V 50 Hz	G-AM671P-235-I/2 ⑥	G-AM671P-235 ⑥	G-AM675P-235 ⑥	—	G-AM671P-235-Z2 ⑥
320 W PSMH	120/277/347	G-AM3271P-TT-I/2	G-AM3271P-TT	G-AM3275P-TT	—	G-AM3271P-TT-Z2
	230 V 50 Hz	G-AM3271P-235-I/2 ⑥	G-AM3271P-235 ⑥	G-AM3275P-235 ⑥	—	G-AM3271P-235-Z2 ⑥
400 W PSMH	120/277/347	G-AM771P-TT-I/2	G-AM771P-TT	G-AM775P-TT	—	G-AM771P-TT-Z2
	230 V 50 Hz	G-AM771P-235-I/2 ⑥	G-AM771P-235 ⑥	G-AM775P-235 ⑥	—	G-AM771P-235-Z2 ⑥
Metal Halide						
175 W MH	120/277/347	G-AM571H-TT-I/2	G-AM571H-TT	G-AM575H-TT	—	G-AM571H-TT-Z2
	220 V 50 Hz	G-AM571H-225-I/2 ⑥	G-AM571H-225 ⑥	G-AM575H-225 ⑥	—	G-AM571H-225-Z2 ⑥
	600 ⑦	G-AM571H-C7-I/2	G-AM571H-C7	G-AM575H-C7	—	G-AM571H-C7-Z2
250 W MH	120/277/347	G-AM671H-TT-I/2	G-AM671H-TT	G-AM675H-TT	—	G-AM671H-TT-Z2
	220 V 50 Hz	G-AM671H-225-I/2 ⑥	G-AM671H-225 ⑥	G-AM675H-225 ⑥	—	G-AM671H-225-Z2 ⑥
	600 ⑦	G-AM671H-C7-I/2	G-AM671H-C7	G-AM675H-C7	—	G-AM671H-C7-Z2
400 W MH	120/277/347	G-AM771H-TT-I/2	G-AM771H-TT	G-AM775H-TT	—	G-AM771H-TT-Z2
	220 V 50 Hz	G-AM771H-225-I/2 ⑥	G-AM771H-225 ⑥	G-AM775H-225 ⑥	—	G-AM771H-225-Z2 ⑥
	600 ⑦	G-AM771H-C7-I/2	G-AM771H-C7	G-AM775H-C7	—	G-AM771H-C7-Z2

① Slip-fits 2" or 2-1/2" pipe-size tenons.

② Add suffix -E to catalog number if provision for quartz emergency option is desired. Furnished with socket installed and pre-wired.

③ Quartz emergency option NOT available for Class I, Division 2 or Class I, Zone 2 fixtures. Classified duty floodlights have 1/2" N.P.T tapped hub for power entry. Use 221 °F/105 °C supply wire.

④ For Hot Restrike Option, add suffix -R.

⑤ For 120 V 50 Hz change -225 to -125, or for 240 V 50 Hz change -225 to -245.

⑥ For 120 V 50 Hz change -235 to -125.

⑦ Supplied complete with CWI Isolated Secondary Ballast for 600 Vac. For 208, 240 or 480 V applications, change the -C7 suffix to -C2, -C3 or -C6 as required.

Ⓜ CSA Certification only.







LIGHTING: ENCLOSED AND GASKETED – FLOODLIGHT

Lighting

Areamaster™ 250/400 Integrally Ballasted Floodlights

70 W, 100 W, 150 W, 250 W, 400 W HPS; 175 W, 200 W, 250 W, 320 W, 400 W PSMH.

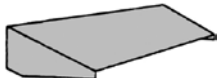
175 W, 250 W, 400 W MH 

Dimensions	Description	Catalog Numbers
Crossarm Mounting Bracket		
	Has 180° horizontal adjustment — degree marked. Facilitates mounting floodlight to crossarm or other flat surface, or to G-AM-8-WB. Includes floodlight yoke bolts. Malleable iron, zinc plated, chromate sealed, architectural bronze polyester finish.	G-AM-8-CA
Pipe or Wall Mount Bracket		
	Used with G-AM-8-CA. Clamps to 1" to 2-1/2" pipe, vertical or horizontal, or mounts on flat surfaces. Includes U-bolt and crossarm bracket bolts. Malleable iron, zinc plated, chromate sealed, with architectural bronze polyester finish.	G-AM-8-WB
Poletop Slip-Fitter		
	Slip-fits 1-1/2" or 2" pipe size poletop tenons. Includes floodlight yoke bolts, 3 locking bolts, and cord grip. Body is malleable iron-zinc plated, chromate sealed, with cast aluminum cap. Assembly has architectural bronze polyester finish.	G-SF20
Locking-Type Photocontrol Receptacle		
	For NEMA type photocontrol, with installation hardware and instructions. Should not be mounted on Class I, Division 2/Class 1, Zone 2 units.	G-1PCR
Vandal Shield		
	UV stabilized polycarbonate, with installation hardware and instructions.	G-AM-6-VS
Top Visor		
	Easy to install with hardware supplied. Aluminum, with architectural bronze POLYESTER finish.	G-AM-6-V
Replacement Lens		
		604249003
Replacement Lens Frame Assembly		
	Complete with Lens	59607383002

 CSA Certification only.

Areamaster™ 250/400 Integrally Ballasted Floodlights







70 W, 100 W, 150 W, 250 W, 400 W HPS; 175 W, 200 W, 250 W, 320 W, 400 W PSMH.







175 W, 250 W, 400 W MH 

NEC: For general, marine and hazardous locations
Class I, Division 2, Groups A, B, C, D
Class I, Zone 2, AEx nR, Groups IIA, IIB, IIC

CEC : For general, marine and hazardous locations
Class I, Division 2, Groups A, B, C, D
Class I, Zone 2, Ex nR, Groups IIA, IIB, IIC
Class II, Division 1 and 2, Groups E, F, G
Class III

NEC/CEC:
IP66
Marine type electric fixtures, outside type (salt water)

Line Voltage	Frequency	Type of Ballast	Starting Amps	Operating Amps	Total Watts
70 Watt High Pressure Sodium					
120	60	HX-HPF	0.90	0.82	94
208	60	HX-HPF	0.50	0.48	94
240	60	HX-HPF	0.44	0.41	94
277	60	HX-HPF	0.35	0.36	94
347 	60	HX-HPF	0.30	0.30	93
480	60	HX-HPF	0.21	0.21	94
120	50	HX-HPF	1.08	0.81	97
220	50	HX-HPF	0.59	0.49	97
240	50	HX-HPF	0.54	0.45	97
100 Watt High Pressure Sodium					
120	60	HX-HPF	1.30	1.15	130
208	60	HX-HPF	0.76	0.67	130
240	60	HX-HPF	0.66	0.60	130
277	60	HX-HPF	0.60	0.52	130
347 	60	HX-HPF	0.45	0.39	130
480	60	HX-HPF	0.33	0.31	135
120	50	HX-HPF	0.90	1.20	130
220	50	HX-HPF	0.50	0.65	130
240	50	HX-HPF	0.45	0.60	130
150 Watt High Pressure Sodium					
120	60	HX-HPF	2.00	1.70	188
208	60	HX-HPF	1.15	0.95	188
240	60	HX-HPF	1.00	0.85	188
277	60	HX-HPF	0.85	0.72	188
347 	60	HX-HPF	0.52	0.56	188
480	60	HX-HPF	0.50	0.47	189
120	50	HX-HPF	1.50	1.60	188
220	50	HX-HPF	0.85	0.90	188
240	50	HX-HPF	0.75	0.80	188
250 Watt High Pressure Sodium					
120	60	CWA	2.00	2.50	295
208	60	CWA	1.20	1.50	295
240	60	CWA	1.00	1.30	295
277	60	CWA	0.85	1.10	295
347 	60	CWA	0.60	0.93	295
480	60	CWA	0.40	0.65	295
120	50	CWA	1.85	2.75	300
230	50	CWA	0.95	1.44	300
400 Watt High Pressure Sodium					
120	60	CWA	3.30	3.80	465
208	60	CWA	1.80	2.20	465
240	60	CWA	1.60	1.90	465
277	60	CWA	1.40	1.70	465
347 	60	CWA	1.00	1.32	464
480	60	CWA	0.80	1.00	465
120	50	CWA	3.70	4.00	465
230	50	CWA	1.85	2.00	465
175 Watt Pulse Start Metal Halide					
120	60	Super CWA	0.90	1.78	199
208	60	Super CWA	0.50	1.08	199
240	60	Super CWA	0.35	0.89	199
277	60	Super CWA	0.30	0.76	199
347 	60	Super CWA	0.25	0.65	208
480	60	Super CWA	0.25	0.50	213
200 Watt Pulse Start Metal Halide					
120	60	Super CWA	2.10	2.00	235
208	60	Super CWA	1.15	1.25	235
240	60	Super CWA	1.10	1.00	235
277	60	Super CWA	0.75	0.85	235
347 	60	Super CWA	0.25	0.70	232
480	60	Super CWA	0.35	0.50	237

Line Voltage	Frequency	Type of Ballast	Starting Amps	Operating Amps	Total Watts
250 Watt Pulse Start Metal Halide					
120	60	Super CWA	1.90	2.50	288
208	60	Super CWA	1.10	1.45	288
240	60	Super CWA	0.96	1.25	288
277	60	Super CWA	0.85	1.10	288
347 	60	Super CWA	0.62	0.90	291
480	60	Super CWA	0.45	0.60	285
120	50	Super CWA	1.90	2.60	285
230	50	Super CWA	1.00	1.35	285
320 Watt Pulse Start Metal Halide					
120	60	Super CWA	2.60	3.25	368
208	60	Super CWA	1.50	1.90	368
240	60	Super CWA	1.30	1.65	368
277	60	Super CWA	1.15	1.40	368
347 	60	Super CWA	0.70	1.10	368
480	60	Super CWA	0.60	0.80	368
120	50	Super CWA	2.28	3.05	365
230	50	Super CWA	1.14	1.60	365
400 Watt Pulse Start Metal Halide					
120	60	Super CWA	3.50	4.00	454
208	60	Super CWA	2.00	2.30	454
240	60	Super CWA	1.25	2.00	454
277	60	Super CWA	1.50	1.75	454
347 	60	Super CWA	1.10	1.35	452
480	60	Super CWA	0.90	1.00	454
120	50	Super CWA	3.17	3.90	454
230	50	Super CWA	1.65	2.00	454
175 Watt Metal Halide 					
120	60	CWA	1.30	1.80	213
208	60	CWA	0.75	1.10	213
240	60	CWA	0.65	0.90	213
277	60	CWA	0.55	0.80	213
347	60	CWA	0.50	0.65	210
480	60	CWA	0.35	0.45	213
120	50	CWA	1.70	1.90	210
220	50	CWA	0.80	1.10	210
250 Watt Metal Halide 					
120	60	CWA	1.20	2.60	295
208	60	CWA	0.65	1.50	295
240	60	CWA	0.60	1.30	295
277	60	CWA	0.50	1.12	295
347	60	CWA	0.80	0.90	295
480	60	CWA	0.30	0.65	298
120	50	CWA	2.00	2.50	285
220	50	CWA	0.94	1.30	285
400 Watt Metal Halide 					
120	60	CWA	3.25	4.00	458
208	60	CWA	1.90	2.30	458
240	60	CWA	1.65	2.00	458
277	60	CWA	1.40	1.75	458
347	60	CWA	1.20	1.40	460
480	60	CWA	0.85	1.00	462
120	50	CWA	2.70	4.10	480
220	50	CWA	1.50	2.20	480

LIGHTING: ENCLOSED AND GASKETED – FLOODLIGHT

 CSA Certification only.

Areamaster™ 250/400 Integrally Ballasted Floodlights

70 W, 100 W, 150 W, 250 W, 400 W HPS; 175 W, 200 W, 250 W, 320 W, 400 W PSMH.

175 W, 250 W, 400 W MH 

Typical Footcandle Values ♦

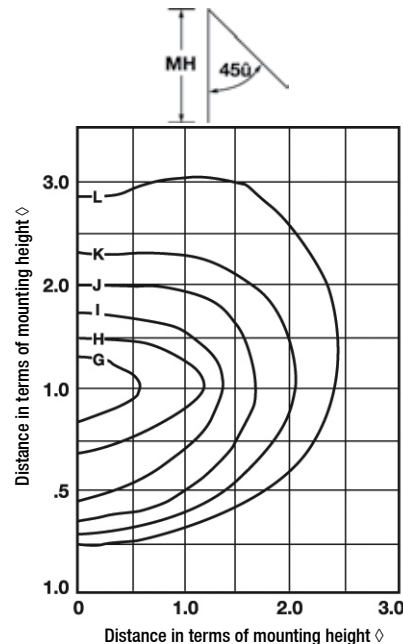
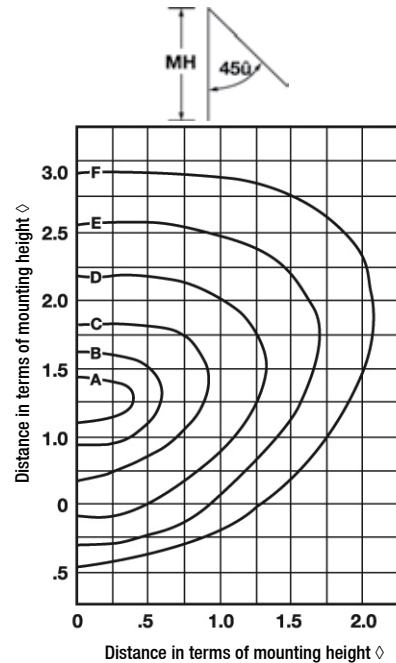

Mtg. Ht.	Ft. Cdles for Iso-Footcandle Lines					
	A	B	C	D	E	F
400W HPS						
60'/18.3m	3.27	2.74	1.82	0.92	0.37	0.18
50'/15.2m	4.74	4.00	2.90	1.37	0.52	0.27
40'/12.2m	7.65	6.28	4.38	2.27	0.82	0.43
30'/9.1m	13.10	10.92	7.83	3.47	1.45	0.77
20'/6.1m	28.22	25.55	17.37	7.28	3.46	1.82

400W MH 						
60'/18.3m	2.32	1.66	1.00	0.58	0.33	0.17
50'/15.2m	3.32	2.32	1.49	0.76	0.48	0.25
40'/12.2m	5.48	3.62	2.32	1.33	0.75	0.36
30'/9.1m	9.79	7.80	3.98	2.16	1.33	0.68
20'/6.1m	17.26	14.60	9.30	5.31	3.15	1.49

For 400W PSMH multiply FC values by 1.29; for 320W PSMH use 0.97.

400W PSMH						
60'/18.3m	2.60	1.86	1.12	0.65	0.37	0.19
50'/15.2m	3.72	2.60	1.66	0.85	0.54	0.28
40'/12.2m	6.14	4.05	2.60	1.49	0.84	0.40
30'/9.1m	10.96	8.74	4.46	2.42	1.49	0.76
20'/6.1m	19.33	16.35	10.41	5.94	3.53	1.67

Mtg. Ht.	Ft. Cdles for Iso-Footcandle Lines					
	G	H	I	J	K	L
70W HPS						
10'/3.0m	10.00	5.00	2.50	1.00	0.50	0.25
20'/6.1m	2.50	1.00	0.50	0.25	0.10	0.05
30'/9.1m	1.00	0.50	0.25	0.10	0.05	0.02

For 100W HPS lamps, multiply FC values by 1.5. For 150W HPS lamps, multiply FC values by 2.5.

Mtg. Ht.	Ft. Cdles for Iso-Footcandle Lines					
	A	B	C	D	E	F
250W HPS						
60'/18.3m	1.96	1.64	1.09	0.55	0.22	0.11
50'/15.2m	2.84	2.40	1.74	0.82	0.31	0.16
40'/12.2m	4.58	3.76	2.62	1.36	0.49	0.26
30'/9.1m	7.85	6.54	4.69	2.08	0.87	0.46
20'/6.1m	16.90	15.30	10.40	4.36	2.07	1.09

250W MH 						
60'/18.3m	1.40	1.00	0.60	0.35	0.20	0.10
50'/15.2m	2.00	1.40	0.90	0.46	0.29	0.15
40'/12.2m	3.30	2.18	1.40	0.80	0.45	0.22
30'/9.1m	5.90	4.70	2.40	1.30	0.80	0.41
20'/6.1m	10.40	8.80	5.60	3.20	1.90	0.90

For 175W MH lamps, multiply FC values by 0.68. For 175W PSMH Lamps 0.85; for 200W PSMH use 1.03; for 250W PSMH use 1.22.

250W PSMH						
60'/18.3m	1.90	1.63	0.82	0.48	0.27	0.14
50'/15.2m	2.72	1.90	1.22	0.63	0.39	0.20
40'/12.2m	4.48	2.96	1.90	1.09	0.61	0.30
30'/9.1m	8.00	6.40	3.26	1.76	1.09	0.55
20'/6.1m	14.40	11.97	7.61	4.35	2.58	1.22

For 175W MH lamps, multiply FC values by 0.68. For 175W PSMH Lamps 0.85; for 200W PSMH use 1.03; for 250W PSMH use 1.22.

♦ (i.e., ratio of distance to height. Example: @ 20'/6.1 m mounting height, 1 means 20'/6.1 m; 2 means 40'/12.2 m, etc.

♦ Photometric charts available on request.

 CSA Certification only.