

IEC Watertight Pin and Sleeve Receptacles, Connectors and Plugs

International Standard 309

Applications

- IEC 309 nonmetallic, watertight, pin and sleeve receptacles, connectors and plugs have been designed with the highest performance standards to withstand extreme conditions.
- Watertight, positive locking, color-coded molded housings will meet your most extreme application requirements head on.

Features

- Singly rated configurations meet the International Standard IEC 309-1, 309-2 and CSA standards for singly rated, non-interchangeable configuration for every voltage and type of service.
- Four housing sizes with North American amperages ranging from 20 to 100 with 3-, 4-, or 5-Wire.
- Voltage is determined by the location of the female ground contact relative to the housing keyway. The voltage color coding diagram to the right shows the keying position and the color coding associated with each voltage.
- All accessories will make and break the maximum current at maximum voltage.
- Insulation resistance: 3 pin = 480 Vac, 4 & 5 pin = 600 Vac.
- Devices will withstand impacts of more than six times that required in IEC 309-2.
- Product identification is indelibly marked on the body of the plug and the lid of the receptacle/connector.
- Plugs and connectors accept clamp and seal cables of overall diameters from 0.40 in. to 1.06 in. and withstand axial loads of 30 lbs. (13kg) and torque loads of 0.4 ft. lbs. (0.54Nm).
- Protected against penetration of water to UL50 level 4X, IEC 529 IPX7, and CSA 4X (immersion to a depth of 1 meter).

Compliances

- UL Listed: E145917
- UL Standard: 1682 (1993), 1686 (1993)
- IEC 309-2 (Tested by BSI)
- CSA 22.2 No. 182.1
- NEMA & CSA 4X, IPX7

Watertight Pin and Sleeve Products

Clock Position	2-Pole/ 3-Wire	3-Pole/ 4-Wire	4-Pole/ 5-Wire
1			
2			
3			
4			
5			
6			
7			
8			
9			
10			
11			
12			

Configuration	Key	Voltage
		100 Vac - 130 Vac = Yellow
		125 Vac - 250 Vac = Orange
		200 Vac/250 Vac = Blue
		277 Vac = Gray
		380 Vac/480 Vac = Red
		500 Vac/600 Vac = Black

Watertight Application Guide

Industry	Watertight
Agriculture	Outdoor portable equipment (i.e. lighting, pumps, heaters)
Chemical Processing	Where subject to corrosion, water and rough use.
Construction	Outdoors in severe conditions under rough use.
Entertainment	Outdoors in severe conditions under rough use.
Food Processing	Where subject to corrosion, water and rough use.
Food Service	Areas subject to frequent cleaning/wash downs.
Manufacturing	Where subject to corrosion, water and rough use.
Military	Outdoors in severe conditions under rough use.

IEC Watertight Pin and Sleeve Connectors

International Standard 309

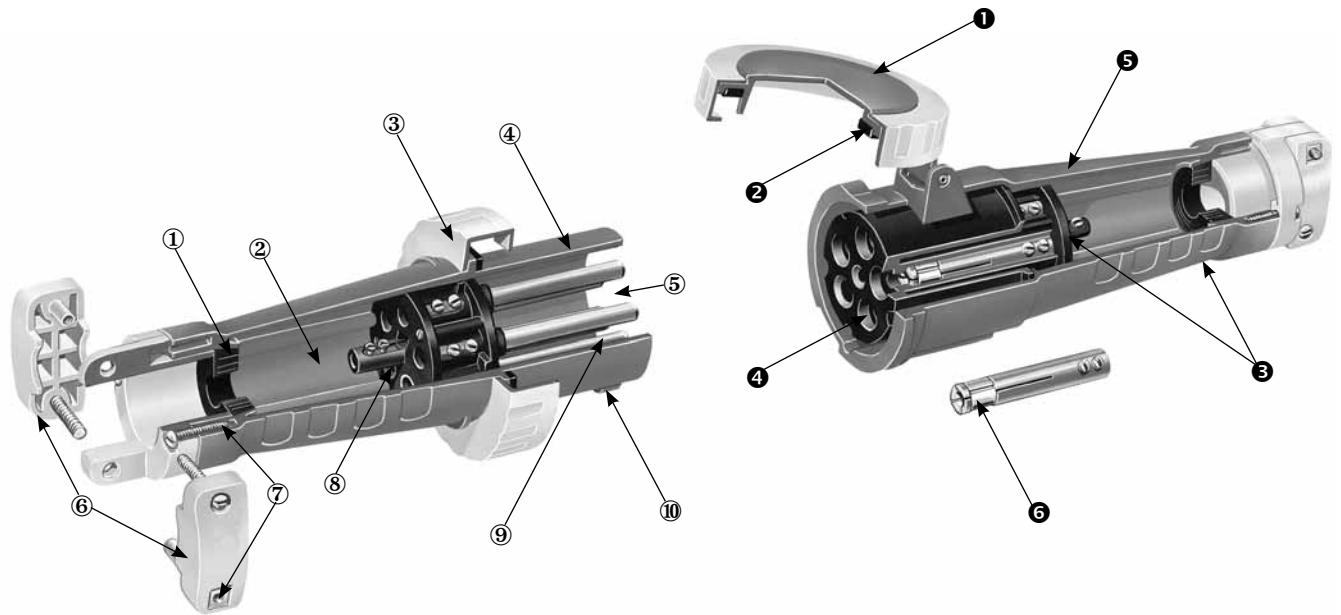

- ① **Cable Gasket:** "Onion" type seal in oil-resistant synthetic rubber. The inner rings can be removed to enable it to fit any cable in the range of 0.40" – 1.06" O.D. (10.2mm – 27mm).
- ② **Space:** Plenty of distance between the seal and the terminals makes connecting the flexible cable easy.
- ③ **Clamping Ring:** Engages with a ramp on the receptacle to make a watertight joint.
- ④ **Shrouded Pins:** Pins protect from accidental damage while the user is protected from touching live pins.
- ⑤ **3, 4, and 5 Pin:** Versions meet all the configurations in UL 1686 and CSA 22.2 No. 182.1.
- ⑥ **Clamp:** External, heavy-duty cable clamp coupled with an outside seal. The seal is protected against damage when the cable flexes.
- ⑦ **Stainless Steel Screws**
- ⑧ **Terminal Marking:** Marked to North American Standards — white for grounded (neutral), green for grounding (earth).
- ⑨ **Ground Pin:** The ground pin is larger than the live (phase) or neutral pin. This ensures that phases can not be crossed. Ground is first to make and last to break.
- ⑩ **Key & Keyway:** Key on the plug aligns with a keyway on the connector/receptacle.

- ① **Stainless Steel Spring Loaded Lid:** Ensures that the receptacle or connector, when there is no plug present, meets the requirements of IPX6 (hose down) and IPX7 (immersion to 1 meter).
- ② **Gasket:** Remains effective after being left clamped tight for a long period or after being repeatedly clamped and unclamped.
- ③ **Materials of Main Components for 20 and 30 Amp:** The interior, which also holds the pins and sleeves, is made in flame retardant high impact PBT. The body of high impact nylon.
- ④ **Materials of Main Components for 60 and 100 Amp:** High impact nylon body. The interior is made in an arc resistant flame retardant nylon, specially formulated to exceed the glow-wire test requirements.
- ⑤ **Orientation and Voltage Matching:** Plugs cannot be inserted in connectors/receptacles configured for different voltages. The position of the earth pin/sleeve relative to that of the keyway is changed for each voltage.
- ⑥ **Color:** All accessories are color coded to match the voltage and ground pin sleeve position.
- ⑦ **Sleeves:** Spring steel collars ensure ease of insertion with excellent pin retention.

Catalog Numbering Guide

PM	5	20	P	5	W
	3-Wire	20 Amp	P = Plug	4, 5, 6, 7, 9, 12	Watertight
	4-Wire	30 Amp	RS = Receptacle, Straight	O'Clock	
	5-Wire	60 Amp	RA = Receptacle, Angled	Ground Pole Position (voltage indicated by clock position)	
		100 Amp	MI = Receptacle, Interlocked		
			C = Connector		
			B = Inlet		

IEC Watertight Pin and Sleeve Plugs and Connectors

International Standard 309

PIN AND SLEEVE PLUGS AND RECEPTACLES, NON-HAZARDOUS LOCATION

D

	Color	Amps	Volts	2-Pole/3-Wire	3-Pole/4-Wire	4-Pole/5-Wire
Watertight Plugs						
	Yellow	20	110-130	PM320 P4W	—	—
	Orange	20	125-250	—	PM420 P12W	—
	Blue	20	250	PM320 P6W	PM420 P9W	PM520 P9W
	Red	20	480	PM320 P7W	PM420 P7W	PM520 P7W
	Black	20	600	—	PM420 P5W	PM520 P5W
	Yellow	30	110-130	PM330 P4W	—	—
	Orange	30	125-250	—	PM430 P12W	—
	Blue	30	250	PM330 P6W	PM430 P9W	PM530 P9W
	Red	30	480	PM330 P7W	PM430 P7W	PM530 P7W
	Black	30	600	—	PM430 P5W	PM530 P5W
	Yellow	60	110-130	PM360 P4W	—	—
	Orange	60	125-250	—	PM460 P12W	—
	Blue	60	250	PM360 P6W	PM460 P9W	PM560 P9W
	Red	60	480	PM360 P7W	PM460 P7W	PM560 P7W
	Black	60	600	—	PM460 P5W	PM560 P5W
	Yellow	100	110-130	PM3100 P4W	—	—
	Orange	100	125-250	—	PM4100 P12W	—
	Blue	100	250	PM3100 P6W	PM4100 P9W	PM5100 P9W
	Red	100	480	PM3100 P7W	PM4100 P7W	PM5100 P7W
	Black	100	600	—	PM4100 P5W	PM5100 P5W



Watertight Connectors						
	Yellow	20	110-130	PM320 C4W	—	—
	Orange	20	125-250	—	PM420 C12W	—
	Blue	20	250	PM320 C6W	PM420 C9W	PM520 C9W
	Red	20	480	PM320 C7W	PM420 C7W	PM520 C7W
	Black	20	600	—	PM420 C5W	PM520 C5W
	Yellow	30	110-130	PM330 C4W	—	—
	Orange	30	125-250	—	PM430 C12W	—
	Blue	30	250	PM330 C6W	PM430 C9W	PM530 C9W
	Red	30	480	PM330 C7W	PM430 C7W	PM530 C7W
	Black	30	600	—	PM430 C5W	PM530 C5W
	Yellow	60	110-130	PM360 C4W	—	—
	Orange	60	125-250	—	PM460 C12W	—
	Blue	60	250	PM360 C6W	PM460 C9W	PM560 C9W
	Red	60	480	PM360 C7W	PM460 C7W	PM560 C7W
	Black	60	600	—	PM460 C5W	PM560 C5W
	Yellow	100	110-130	PM3100 C4W	—	—
	Orange	100	125-250	—	PM4100 C12W	—
	Blue	100	250	PM3100 C6W	PM4100 C9W	PM5100 C9W
	Red	100	480	PM3100 C7W	PM4100 C7W	PM5100 C7W
	Black	100	600	—	PM4100 C5W	PM5100 C5W



IEC Watertight Pin and Sleeve Receptacles and Inlet/Reverse Service

International Standard 309

	Color	Amps	Volts	2-Pole/3-Wire	3-Pole/4-Wire	4-Pole/5-Wire
Watertight Receptacles (Panel Straight)						
	Yellow	20	110-130	PM320 RS4W	—	—
	Orange	20	125-250	—	PM420 RS12W	—
	Blue	20	250	PM320 RS6W	PM420 RS9W	PM520 RS9W
	Red	20	480	PM320 RS7W	PM420 RS7W	PM520 RS7W
	Black	20	600	—	PM420 RS5W	PM520 RS5W
	Yellow	30	110-130	PM330 RS4W	—	—
	Orange	30	125-250	—	PM430 RS12W	—
	Blue	30	250	PM330 RS6W	PM430 RS9W	PM530 RS9W
	Red	30	480	PM330 RS7W	PM430 RS7W	PM530 RS7W
	Black	30	600	—	PM430 RS5W	PM530 RS5W
	Yellow	60	110-130	PM360 RS4W	—	—
	Orange	60	125-250	—	PM460 RS12W	—
	Blue	60	250	PM360 RS6W	PM460 RS9W	PM560 RS9W
	Red	60	480	PM360 RS7W	PM460 RS7W	PM560 RS7W
	Black	60	600	—	PM460 RS5W	PM560 RS5W
	Yellow	100	110-130	PM3100 RS4W	—	—
	Orange	100	125-250	—	PM4100 RS12W	—
	Blue	100	250	PM3100 RS6W	PM4100 RS9W	PM5100 RS9W
	Red	100	480	PM3100 RS7W	PM4100 RS7W	PM5100 RS7W
	Black	100	600	—	PM4100 RS5W	PM5100 RS5W
Watertight Inlet/Reverse Service						
	Yellow	20	110-130	PM320 B4W	—	—
	Orange	20	125-250	—	PM420 B12W	—
	Blue	20	250	PM320 B6W	PM420 B9W	PM520 B9W
	Red	20	480	PM320 B7W	PM420 B7W	PM520 B7W
	Black	20	600	—	PM420 B5W	PM520 B5W
	Yellow	30	110-130	PM330 B4W	—	—
	Orange	30	125-250	—	PM430 B12W	—
	Blue	30	250	PM330 B6W	PM430 B9W	PM530 B9W
	Red	30	480	PM330 B7W	PM430 B7W	PM530 B7W
	Black	30	600	—	PM430 B5W	PM530 B5W
	Yellow	60	110-130	PM360 B4W	—	—
	Orange	60	125-250	—	PM460 B12W	—
	Blue	60	250	PM360 B6W	PM460 B9W	PM560 B9W
	Red	60	480	PM360 B7W	PM460 B7W	PM560 B7W
	Black	60	600	—	PM460 B5W	PM560 B5W
	Yellow	100	110-130	PM3100 B4W	—	—
	Orange	100	125-250	—	PM4100 B12W	—
	Blue	100	250	PM3100 B6W	PM4100 B9W	PM5100 B9W
	Red	100	480	PM3100 B7W	PM4100 B7W	PM5100 B7W
	Black	100	600	—	PM4100 B5W	PM5100 B5W

PIN AND SLEEVE PLUGS AND RECEPTACLES, NON-HAZARDOUS LOCATION

IEC Watertight Pin and Sleeve Receptacles

International Standard 309



D
PIN AND SLEEVE PLUGS AND RECEPTACLES, NON-HAZARDOUS LOCATION

Color	Amps	Config.	Volts	Interlocked Switch Receptacle	Surface Mount Angle Receptacle (20 and 30 Amp)	Surface Mount Angle Receptacle (60 Amp)	IP67 Watertight Caps
Yellow	20	2P-3W	125	PM320 MI4W	PM320 RA4W	-	PM163PC
Blue	20	2P-3W	250	PM320 MI6W	PM320 RA6W	-	PM163PC
Red	20	2P-3W	480	PM320 MI7W	PM320 RA7W	-	PM163PC
Orange	20	3P-4W	125/250	PM420 MI12W	PM420 RA12W	-	PM164PC
Blue	20	3P-4W	250	PM420 MI9W	PM420 RA9W	-	PM164PC
Red	20	3P-4W	480	PM420 MI7W	PM420 RA7W	-	PM164PC
Black	20	3P-4W	600	PM420 MI5W	PM420 RA5W	-	PM164PC
Blue	20	4P-5W	250	PM520 MI9W	PM520 RA9W	-	PM165PC
Red	20	4P-5W	480	PM520 MI7W	PM520 RA7W	-	PM165PC
Black	20	4P-5W	600	PM520 MI5W	PM520 RA5W	-	PM165PC
Yellow	30	2P-3W	125	PM330 MI4W	PM330 RA4W	-	PM323PC
Blue	30	2P-3W	250	PM330 MI6W	PM330 RA6W	-	PM323PC
Red	30	2P-3W	480	PM330 MI7W	PM330 RA7W	-	PM323PC
Orange	30	3P-4W	125/250	PM430 MI12W	PM430 RA12W	-	PM324PC
Blue	30	3P-4W	250	PM430 MI9W	PM430 RA9W	-	PM324PC
Red	30	3P-4W	480	PM430 MI7W	PM430 RA7W	-	PM324PC
Black	30	3P-4W	600	PM430 MI5W	PM430 RA5W	-	PM324PC
Blue	30	4P-5W	250	PM530 MI9W	PM530 RA9W	-	PM325PC
Red	30	4P-5W	480	PM530 MI7W	PM530 RA7W	-	PM325PC
Black	30	4P-5W	600	PM530 MI5W	PM530 RA5W	-	PM325PC
Yellow	60	2P-3W	125	PM360 MI4W	-	PM360 RA4W	PM63345PC
Blue	60	2P-3W	250	PM360 MI6W	-	PM360 RA6W	PM63345PC
Red	60	2P-3W	480	PM360 MI7W	-	PM360 RA7W	PM63345PC
Orange	60	3P-4W	125/250	PM460 MI12W	-	PM460 RA12W	PM63345PC
Blue	60	3P-4W	250	PM460 MI9W	-	PM460 RA9W	PM63345PC
Red	60	3P-4W	480	PM460 MI7W	-	PM460 RA7W	PM63345PC
Black	60	3P-4W	600	PM460 MI5W	-	PM460 RA5W	PM63345PC
Blue	60	4P-5W	250	PM560 MI9W	-	PM560 RA9W	PM63345PC
Red	60	4P-5W	480	PM560 MI7W	-	PM560 RA7W	PM63345PC
Black	60	4P-5W	600	PM560 MI5W	-	PM560 RA5W	PM63345PC

AE Series Mounting Boxes

For IEC Watertight Pin and Sleeve Receptacles

20 and 30 Amp



Hub Size (Inches)	AEE	AERH	AERC
1/2	AEE13	AERH13	AERC13
3/4	AEE23	AERH23	AERC23
1	AEE33	AERH33	AERC33

60 and 100 Amp



Hub Size (Inches)	AEE	AERH	AERC
1	AEE36	AERH36	AERC36
1-1/4	AEE46	AERH46	AERC46
1-1/2	AEE56	AERH56	AERC56

D

PIN AND SLEEVE PLUGS AND RECEPTACLES, NON-HAZARDOUS LOCATION

IEC Watertight Pin and Sleeve Plug, Connector and Receptacle Dimensions

International Standard 309

D

PIN AND SLEEVE PLUGS AND RECEPTACLES, NON-HAZARDOUS LOCATION

		Dimensions in Inches/Millimeters											
		20 Amp			30 Amp			60 Amp			100 Amp		
Poles		3	4	5	3	4	5	3	4	5	3	4	5
Watertight Plug													
A		2.83/71.8	3.14/79.7	3.54/89.9	3.74/94.9	3.74/94.9	4.01/101.8	4.33/109.9	4.33/109.9	4.33/109.9	4.64/117.8	4.64/117.8	4.64/117.8
B		1.79/45.4	1.79/45.4	1.79/45.4	2.12/53.8	2.12/53.8	2.12/53.8	2.63/66.8	2.63/66.8	2.63/66.8	2.83/71.8	2.83/71.8	2.83/71.8
C		5.74/145.7	5.74/145.7	5.74/145.7	6.41/162.8	6.41/162.8	6.41/162.8	9.37/237.9	9.37/237.9	9.37/237.9	11.61/294.8	11.61/294.8	11.61/294.8

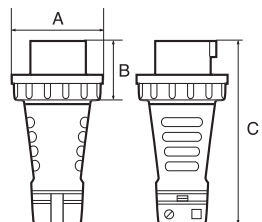

Watertight Connector													
A		2.83/71.8	3.18/80.7	3.50/88.9	3.74/94.9	3.74/94.9	3.74/94.9	4.33/109.9	4.33/109.9	4.33/109.9	4.72/119.8	4.72/119.8	4.72/119.8
B		3.18/80.7	3.50/88.9	3.89/98.8	4.01/101.8	4.01/101.8	4.01/101.8	4.44/112.7	4.44/112.7	4.44/112.7	4.96/125.9	4.96/125.9	4.96/125.9
C		6.06/153.9	6.06/153.9	6.06/153.9	7.00/177.8	7.00/177.8	7.00/177.8	10.03/254.7	10.03/254.7	10.03/254.7	11.81/299.9	11.81/299.9	11.81/299.9

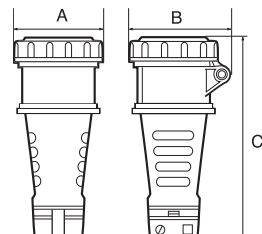

Watertight Receptacle (Panel Straight)													
A		3.07/77.9	3.07/77.9	3.07/77.9	3.07/77.9	3.07/77.9	3.07/77.9	3.85/97.7	3.85/97.7	3.85/97.7	3.85/97.7	3.85/97.7	3.85/97.7
B		3.26/82.8	3.26/82.8	3.26/82.8	3.26/82.8	3.26/82.8	3.26/82.8	4.21/106.9	4.21/106.9	4.21/106.9	4.21/106.9	4.21/106.9	4.21/106.9
C		2.95/74.9	2.95/74.9	2.95/74.9	2.95/74.9	2.95/74.9	2.95/74.9	5.51/139.9	5.51/139.9	5.51/139.9	6.22/157.9	6.22/157.9	6.22/157.9
D		3.07/77.9	3.07/77.9	3.07/77.9	3.07/77.9	3.07/77.9	3.07/77.9	3.85/97.7	3.85/97.7	3.85/97.7	3.85/97.7	3.85/97.7	3.85/97.7
E		2.71/68.8	2.71/68.8	2.71/68.8	2.71/68.8	2.71/68.8	2.71/68.8	3.50/88.8	3.50/88.8	3.50/88.8	3.50/88.8	3.50/88.8	3.50/88.8
F		2.71/68.8	2.71/68.8	2.71/68.8	2.71/68.8	2.71/68.8	2.71/68.8	3.50/88.8	3.50/88.8	3.50/88.8	3.50/88.8	3.50/88.8	3.50/88.8
G		0.55/13.9	0.55/13.9	0.55/13.9	0.55/13.9	0.55/13.9	0.55/13.9	2.08/52.8	2.08/52.8	2.08/52.8	2.67/67.8	2.67/67.8	2.67/67.8
H		0.23/5.8	0.23/5.8	0.23/5.8	0.23/5.8	0.23/5.8	0.23/5.8	0.23/5.8	0.23/5.8	0.23/5.8	0.23/5.8	0.23/5.8	0.23/5.8
I		2.12/53.8	2.12/53.8	2.12/53.8	2.12/53.8	2.12/53.8	2.12/53.8	2.75/69.8	2.75/69.8	2.75/69.8	3.14/79.7	3.14/79.7	3.14/79.7
J		0.21/5.3	0.21/5.3	0.21/5.3	0.21/5.3	0.21/5.3	0.21/5.3	0.29/7.3	0.29/7.3	0.29/7.3	0.29/7.3	0.29/7.3	0.29/7.3
K		2.12/53.8	2.12/53.8	2.12/53.8	2.12/53.8	2.12/53.8	2.12/53.8	2.75/69.8	2.75/69.8	2.75/69.8	2.75/69.8	2.75/69.8	2.75/69.8

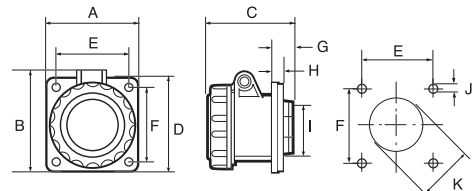

IEC Watertight Pin and Sleeve Receptacle Dimensions

International Standard 309

Watertight Inlet/Reverse Service Receptacle

Poles	Dimensions in Inches/Millimeters											
	20 Amp			30 Amp			60 Amp			100 Amp		
	3	4	5	3	4	5	3	4	5	3	4	5
A	3.07/77.9	3.07/77.9	3.07/77.9	3.07/77.9	3.07/77.9	3.85/97.7	3.85/97.7	3.85/97.7	3.85/97.7	3.85/97.7	3.85/97.7	3.85/97.7
B	3.07/77.9	3.07/77.9	3.07/77.9	3.07/77.9	3.07/77.9	3.85/97.7	3.85/97.7	3.85/97.7	3.85/97.7	3.85/97.7	3.85/97.7	3.85/97.7
C	2.67/67.8	2.67/67.8	2.67/67.8	2.91/73.9	2.91/73.9	2.91/73.9	4.64/117.8	4.64/117.8	4.64/117.8	5.62/142.7	5.62/142.7	5.62/142.7
D	2.71/68.8	2.71/68.8	2.71/68.8	2.71/68.8	2.71/68.8	2.71/68.8	3.50/88.8	3.50/88.8	3.50/88.8	3.50/88.8	3.50/88.8	3.50/88.8
E	2.71/68.8	2.71/68.8	2.71/68.8	2.71/68.8	2.71/68.8	2.71/68.8	3.50/88.8	3.50/88.8	3.50/88.8	3.50/88.8	3.50/88.8	3.50/88.8
F	3.46/87.8	3.46/87.8	3.46/87.8	3.70/93.9	3.70/93.9	3.70/93.9	4.37/110.9	4.37/110.9	4.37/110.9	4.76/120.9	4.76/120.9	4.76/120.9
G	2.12/53.8	2.12/53.8	2.12/53.8	2.12/53.8	2.12/53.8	2.12/53.8	2.75/69.8	2.75/69.8	2.75/69.8	2.75/69.8	2.75/69.8	2.75/69.8
H	0.21/5.3	0.21/5.3	0.21/5.3	0.21/5.3	0.21/5.3	0.21/5.3	0.29/7.3	0.29/7.3	0.29/7.3	0.29/7.3	0.29/7.3	0.29/7.3
I	0.33/8.3	0.33/8.3	0.33/8.3	0.33/8.3	0.33/8.3	0.33/8.3	0.33/8.3	0.33/8.3	0.33/8.3	0.33/8.3	0.33/8.3	0.33/8.3

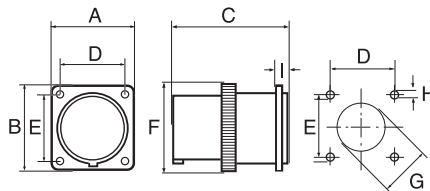

Watertight Interlocked Switch Receptacle

Poles	Dimensions in Inches/Millimeters								
	20 Amp			30 Amp			60 Amp		
	3	4	5	3	4	5	3	4	5
A	4.40/11.1	4.40/11.1	4.40/11.1	4.80/12.1	4.80/12.1	4.80/12.1	6.53/16.5	6.53/16.5	6.53/16.5
B	7.00/17.7	7.00/17.7	7.00/17.7	8.34/21.1	8.34/21.1	8.34/21.1	11.61/29.4	11.61/29.4	11.61/29.4
C	3.62/9.1	3.62/9.1	3.62/9.1	3.97/10.0	3.97/10.0	3.97/10.0	5.31/13.4	5.31/13.4	5.31/13.4
D	5.74/14.5	5.74/14.5	5.74/14.5	6.73/17.0	6.73/17.0	6.73/17.0	10.43/26.4	10.43/26.4	10.43/26.4
E	5.03/12.7	5.03/12.7	5.03/12.7	5.90/14.9	5.90/14.9	5.90/14.9	8.26/20.9	8.26/20.9	8.26/20.9
F	7.67/19.4	7.67/19.4	7.67/19.4	9.13/23.1	9.13/23.1	9.13/23.1	12.99/32.9	12.99/32.9	12.99/32.9
G	0.21/0.5	0.21/0.5	0.21/0.5	0.25/0.6	0.25/0.6	0.25/0.6	0.31/0.7	0.31/0.7	0.31/0.7
H	0.23/0.5	0.23/0.5	0.23/0.5	0.25/0.6	0.25/0.6	0.25/0.6	0.23/0.5	0.23/0.5	0.23/0.5

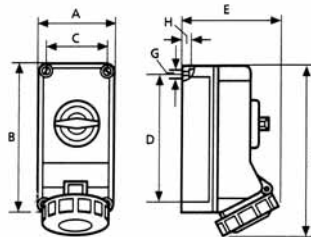

IEC Watertight Pin and Sleeve Receptacle Dimensions

International Standard 309

D

PIN AND SLEEVE PLUGS AND RECEPTACLES, NON-HAZARDOUS LOCATION

Poles	Dimensions in Inches/Centimeters								
	20 Amp			30 Amp			60 Amp		
	3	4	5	3	4	5	3	4	5

Surface Mount Angle Receptacle (20 and 30 Amp)

A	2.75/69.8	2.75/69.8	2.75/69.8	2.75/69.8	2.75/69.8	2.75/69.8	-	-	-
B	3.22/81.7	3.22/81.7	3.22/81.7	3.22/81.7	3.22/81.7	3.22/81.7	-	-	-
C	2.32/58.9	2.32/58.9	2.32/58.9	2.32/58.9	2.32/58.9	2.32/58.9	-	-	-
D	0.51/12.9	0.51/12.9	0.51/12.9	0.51/12.9	0.51/12.9	0.51/12.9	-	-	-
E	3.22/81.7	3.22/81.7	3.22/81.7	3.22/81.7	3.22/81.7	3.22/81.7	-	-	-
F	4.64/11.7	4.64/11.7	4.64/11.7	4.64/11.7	4.64/11.7	4.64/11.7	-	-	-
G	0.20/5.0	0.20/5.0	0.20/5.0	0.20/5.0	0.20/5.0	0.20/5.0	-	-	-
H	0.78/19.8	0.78/19.8	0.78/19.8	0.78/19.8	0.78/19.8	0.78/19.8	-	-	-
I	1.29/32.7	1.29/32.7	1.29/32.7	1.29/32.7	1.29/32.7	1.29/32.7	-	-	-
J	1.25/31.7	1.25/31.7	1.25/31.7	1.25/31.7	1.25/31.7	1.25/31.7	-	-	-
K	0.90/22.8	0.90/22.8	0.90/22.8	0.90/22.8	0.90/22.8	0.90/22.8	-	-	-

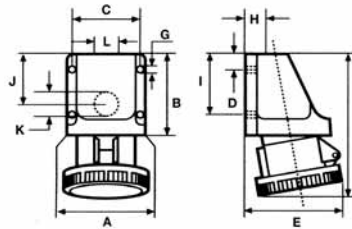

Surface Mount Angle Receptacle (60 Amp)

A	-	-	-	-	-	-	4.80/121.9	4.80/121.9	4.80/121.9
B	-	-	-	-	-	-	8.34/211.8	8.34/211.8	8.34/211.8
C	-	-	-	-	-	-	3.97/100.8	3.97/100.8	3.97/100.8
D	-	-	-	-	-	-	6.73/170.9	6.73/170.9	6.73/170.9
E	-	-	-	-	-	-	6.92/175.7	6.92/175.7	6.92/175.7
F	-	-	-	-	-	-	9.84/249.9	9.84/249.9	9.84/249.9
G	-	-	-	-	-	-	0.21/5.3	0.21/5.3	0.21/5.3
H	-	-	-	-	-	-	0.23/5.8	0.23/5.8	0.23/5.8

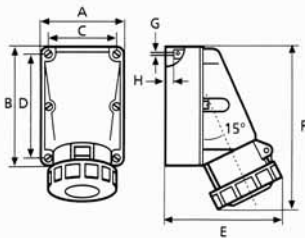

AE Series Mounting Box Dimensions

For IEC Watertight Pin and Sleeve Receptacles

AEE Mounting Box

Amp	Hub Size (Inches)	Dimensions in Inches/Centimeters						
		A	B	C	D	E	F	G
30	1/2, 3/4, 1	4.12/104.6	5.00/127.0	3.33/84.5	4.25/107.9	3.38/85.8	1.18/29.9	1.10/27.9
60	1, 1-1/4, 1-1/2	5.41/137.4	6.38/162.0	4.23/107.4	5.38/136.6	4.25/107.9	1.50/38.1	1.50/38.1

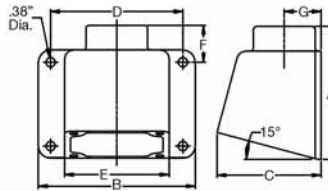

AERC and AERH Mounting Boxes

Amp	Hub Size (Inches)	Dimensions in Inches/Centimeters								
		A *	B **	C	D	E	F	G	H	J
20/30	1/2	0.69/17.5	5.31/134.8	3.38/85.8	3.38/85.8	2.50/63.5	2.63/66.8	4.56/115.8	2.72/69.0	0.94/23.8
20/30	3/4	0.75/19.0	5.31/134.8	3.38/85.8	3.38/85.8	2.50/63.5	2.63/66.8	4.56/115.8	2.72/69.0	0.94/23.8
20/30	1	0.81/20.5	5.31/134.8	3.38/85.8	3.38/8.6	2.50/63.5	2.63/66.8	4.56/115.8	2.72/69.0	0.94/23.8
60/100	1	0.81/20.5	6.50/165.1	4.25/107.9	4.25/107.9	3.13/79.5	3.50/88.9	5.88/149.3	3.50/88.9	1.38/35.0
60/100	1-1/4	0.94/23.8	6.50/165.1	4.25/107.9	4.25/107.9	3.13/79.5	3.50/88.9	5.88/149.3	3.50/88.9	1.38/35.0
60/100	1-1/2	1.00/25.4	6.50/165.1	4.25/107.9	4.25/107.9	3.13/79.5	3.50/88.9	5.88/149.3	3.50/88.9	1.38/35.0

* Dimension "A" for AERA only.

** Dimension "B" for AERC only.

