

TMC CableReady® Connectors For Jacketed Metal Clad Cable

TMC For Non-Hazardous Locations

Applications

- CableReady® connectors are designed for use with the following cables: Type MC – jacketed corrugated aluminum, interlocked aluminum and interlocked steel and Teck cable.
- CableReady® connectors provide a means for terminating jacketed type MC cable, forming a mechanical watertight connection and providing ground continuity for cable armor.
- For use on horizontal or vertical runs.
- For use in non-hazardous locations.
- For Class I and Class II hazardous locations – See TMCX.
- Watertight-NEMA Type 4.

Features

- Simplified construction reduces installation time. No disassembly is required for installation.
- 14 connectors cover a cable armor range of 0.400" to 4.020" in 1/2" to 4" NPT thread sizes.
- Stainless steel grounding spring provides positive ground continuity as well as excellent pull-out resistance.
- Integral "O" ring ensures watertight connection (1/2" thru 2").
- EPDM/Neoprene bushing provides a watertight seal.
- Hex design for easy wrenching.
- 1/2" thru 2" are provided with integral hub sealing ring.
- Watertight-NEMA Type 4

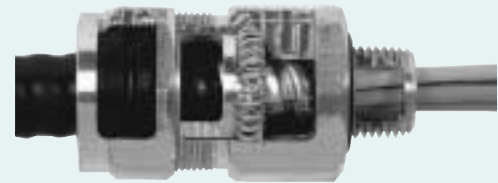
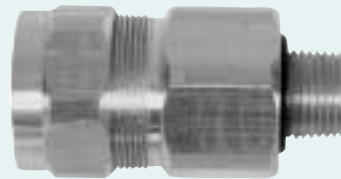

Standard Materials

- Bodies, Sleeve and gland nut are copper-free aluminum or steel.
- Grounding spring is stainless steel.
- Bushing is neoprene/EPDM
- Stop and slip washers are nylon.
- O-ring is Buna N

Size Ranges

- Trade sizes 1/2" thru 4".
- Cable Jacket Diameter Range: 0.500" thru 4.220".
- Cable Armor Diameter Range: 0.400" thru 4.020".

Compliances

- UL Listed
- CSA Certified
- UL Standard 514B
- CSA Standard C22.2 No. 18-98
- NEMA Type 4
- Also CSA Certified for Class II, Division 1, Groups E,F and G; Class III.
- NEMA FB1-1977
- Fed. Spec. A-A-50552 (formerly W-F-406)

Catalog Number		Trade Size	Cable Jacket Diameter Range	Cable Armor Diameter Range	Turning Diameter	Max Core Diameter
Aluminum	Steel					
TMC-5076	TMC-5076S	1/2	0.500 - 0.760	0.400 - 0.660	1.34	.054
TMC-5099	TMC-5099S	1/2	0.725 - 0.990	0.625 - 0.890	1.63	.061
TMC-75121	TMC-75121S	3/4	0.880 - 1.210	0.800 - 1.110	2.00	0.82
TMC-100138	TMC-100138S	1	1.150 - 1.375	1.050 - 1.275	2.23	1.04
TMC-125163	TMC-125163S	1-1/4	1.350 - 1.625	1.250 - 1.525	2.68	1.27
TMC-125188	TMC-125188S	1-1/4	1.575 - 1.875	1.475 - 1.750	2.81	1.37
TMC-150200	TMC-150200S	1-1/2	1.700 - 2.000	1.580 - 1.880	3.06	1.59
TMC-150220	TMC-150220S	1-1/2	1.900 - 2.200	1.780 - 2.080	3.19	1.61
TMC-200238	TMC-200238S	2	1.900 - 2.375	1.780 - 2.250	3.62	2.00
TMC-200275	TMC-200275S	2	2.300 - 2.750	2.180 - 2.630	4.01	2.05
TMC-251250	—	2-1/2	2.100 - 2.660	1.930 - 2.510	4.22	2.25
TMC-304300	—	3	2.600 - 3.320	2.450 - 3.040	4.98	2.75
TMC-359350	—	3-1/2	3.110 - 3.780	2.950 - 3.590	5.50	3.34
TMC-402400	—	4	3.700 - 4.220	3.500 - 4.020	5.84	3.78

All dimensions are in inches.

Class I, Div. 1 and 2
 Groups A,B,C,D
 Class II, Div. 1 and 2
 Groups E,F,G
 Class III
 NEMA 4

CC

TMCX CableReady® Connectors For Jacketed Metal Clad Cable: Explosionproof, Dust-Ignitionproof

TMCX For Hazardous Locations

Applications

● CableReady® connectors are designed for use with the following cables:

Type MC – Jacketed corrugated aluminum, interlocked aluminum and interlocked steel.

CSA Teck Cable

● CableReady® connectors provide a means for terminating jacketed type MC cable, forming a mechanical watertight connection and providing ground continuity for cable armor.

- For use on horizontal or vertical runs.
- Watertight NEMA Type 4
- For use in Class I, Div. 1 & 2 and Class II, Div. 1 & 2 hazardous locations.
- For non-hazardous locations – Use TMC.

Features

- Simplified construction reduces installation time.
- Ten connectors cover a cable armor range of 0.375" to 4.020" in 1/2" to 4" NPT thread sizes.
- Stainless steel grounding spring provides positive ground continuity as well as excellent pull-out resistance.
- Neoprene bushing provides a watertight seal.
- All external metallic parts are manufactured from lightweight, copper-free aluminum to prevent corrosion in harsh environments.
- Watertight – NEMA Type 4
- Hex design for easy wrenching.
- TMCX connectors are furnished complete with epoxy sealing compound.
- For easy identification, TMCX connectors have a distinctly colored gland nut.
- TMCX connectors have a reusable union sleeve that simplifies installation on new construction and guarantees the reusability of connectors when doing repair or replacement work.
- Fewer connectors covering a broader range of cable diameters means a reduced inventory.

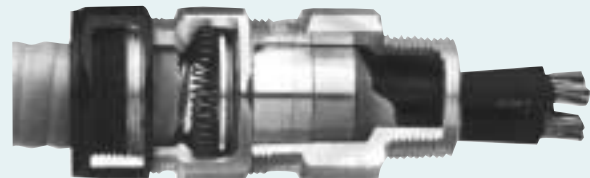

Standard Materials

- Primary and intermediate bodies, sleeve and gland nut are copper-free aluminum.
- Grounding spring is stainless steel.
- Bushing is Neoprene.
- Stop and slip washers are nylon.

Size Ranges

- Trade sizes 1/2" thru 4".
- Cable Jacket Diameter Range: 0.485" thru 4.220".
- Cable Armor Diameter Range: 0.375" thru 4.020".

Compliances

- UL Listed
- CSA Certified
- UL Standards 514B, 2225
- CSA Standard C22.2 No. 174
- NEMA Type 4
- NEMA Standard FB1-1977
- Fed. Spec A-A-50552 (formerly W-F-406)

Catalog Number	Trade Size	Cable Jacket Diameter Range	Cable Armor Diameter Range	Max Core Diameter
TMCX-6550	1/2	0.485 - 0.760	0.375 - 0.650	0.61
TMCX-8875	3/4	0.700 - 0.990	0.600 - 0.880	0.81
TMCX-118100	1	0.900 - 1.300	0.800 - 1.180	1.00
TMCX-140125	1-1/4	1.210 - 1.510	1.100 - 1.400	1.25
TMCX-166150	1-1/2	1.440 - 1.790	1.330 - 1.660	1.44
TMCX-206200	2	1.730 - 2.200	1.570 - 2.060	2.06
TMCX-251250	2-1/2	2.100 - 2.660	1.930 - 2.510	2.25
TMCX-304300	3	2.600 - 3.230	2.450 - 3.040	3.00
TMCX-359350	3-1/2	3.110 - 3.780	2.950 - 3.590	3.44
TMCX-402400	4	3.700 - 4.220	3.500 - 4.020	3.97

All dimensions are in inches.

TMC and TMCX Connector Dimensions

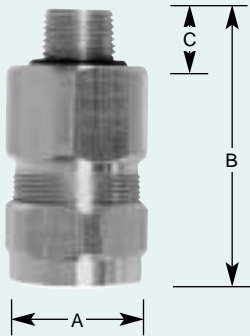

Trade Size	Aluminum and Steel Catalog Number†	A*	B	C	D**
1/2"	TMC-5076	1.34	2.89	0.63	0.54
1/2"	TMC-5099	1.63	3.06	0.63	0.61
3/4"	TMC-75121	2.00	3.18	0.63	0.82
1"	TMC-100138	2.23	3.58	0.78	1.04
1-1/4"	TMC-125163	2.68	4.13	0.94	1.27
1-1/4"	TMC-125188	2.81	4.17	0.94	1.37
1-1/2"	TMC-150200	3.06	4.20	0.94	1.59
1-1/2"	TMC-150220	3.19	4.20	0.94	1.61
2"	TMC-200238	3.62	4.72	0.94	2.00
2"	TMC-200275	4.01	4.84	0.94	2.05
2-1/2"	TMC-251250	4.22	6.38	1.50	2.25
3"	TMC-304300	4.98	7.16	1.50	2.75
3-1/2"	TMC-359350	5.50	7.56	1.63	3.34
4"	TMC-402400	5.84	7.66	1.63	3.78

†Aluminum and steel have same dimensions.

All dimensions are in inches.

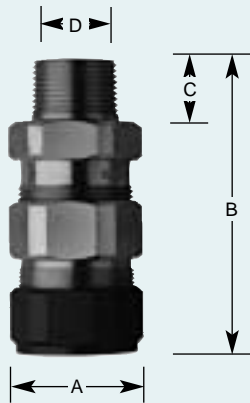

TMCX Dimensions

Trade Size	Aluminum Catalog Number	A*	B	C	D**
1/2"	TMCX-6650	1.38	3.69	0.75	0.61
3/4"	TMCX-8875	1.63	3.88	0.75	0.81
1"	TMCX-118100	2.00	4.41	0.94	1.00
1-1/4"	TMCX-140125	2.44	5.13	1.00	1.25
1-1/2"	TMCX-166150	2.75	5.19	1.00	1.44
2"	TMCX-206200	3.72	6.09	1.00	2.06
2-1/2"	TMCX-251250	4.22	7.69	1.50	2.25
3"	TMCX-304300	4.98	8.47	1.50	3.00
3-1/2"	TMCX-359350	5.50	9.16	1.63	3.44
4"	TMCX-402400	5.84	9.81	1.63	3.97

All dimensions are in inches.

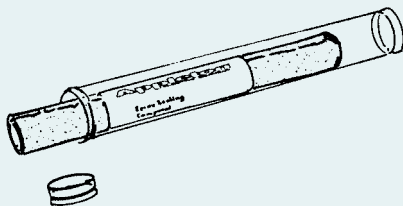

Epoxy Sealing Compound

Tube Size	Description	Catalog No.
1.0 oz.	Epoxy Sealing Compound	TSC1
4.0 oz.	Epoxy Sealing Compound	TSC4

* Turning Diameter
 ** Maximum Core Diameter

CableReady® Connectors For Metal Clad and Tray Cable

TMC For Non-Hazardous Locations TMCX For Hazardous Locations

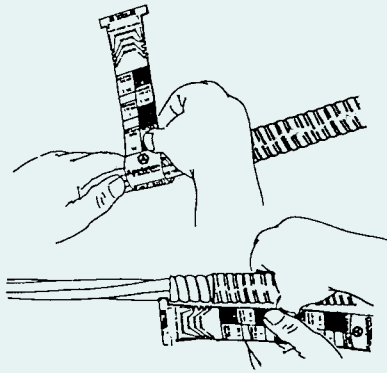

Cable Sizer

Cable connectors are supplied with a gauge/sizer to measure the cable armor and select the proper connector. It also aids in determining how much cable jacket is to be removed and how much compound to pack between and around the cable conductors for TMCX connectors for a proper and safe installation.

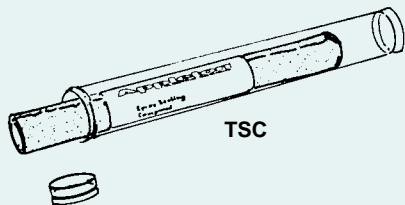

TSC

Epoxy Sealing Compound

Compound for sealing TMCX cable connectors used in hazardous locations. To use, knead the two part epoxy compound into a uniform color, then pack into open spaces between and around all conductors.

Each TMCX connector is supplied with the proper amount of compound to complete one termination. Additional compound is available and can be ordered in 1-ounce and 4-ounce tubes. Complete mixing and application instructions furnished.

TMC Installation

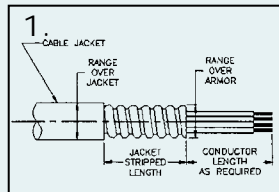

Prepare Cable.
Cut jacket, armor and fillers to expose the desired length of conductor. Strip off outer jacket. Remove burrs.

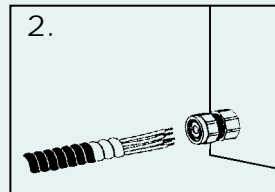

Install Connector.
Install connector into threaded enclosure and tighten BODY securely with wrench. Use locknut if installing into sheet metal enclosure

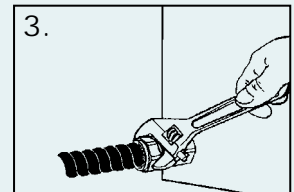

Install Cable.
Insert cable into connector until front of armor or plastic stop washer bottoms against armor stop of body. Securely tighten bushing NUT onto body.

TMCX Installation

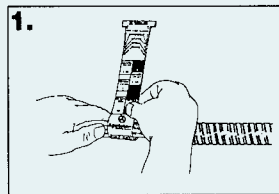

Using cable sizer provided determine connector.

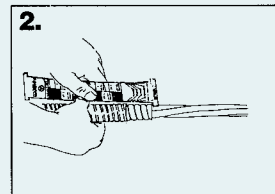

Prepare cable.

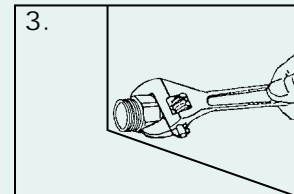

Install primary body into enclosure and slide cap and intermediate body assembly over cable.

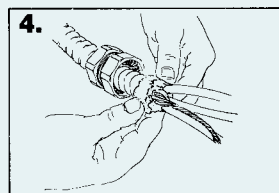

Mix epoxy compound and pack into open spaces between and around all conductors.

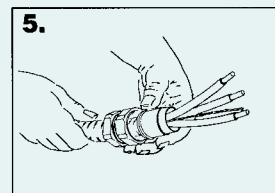

Slip sleeve and sleeve/stopwasher over conductors and pack additional epoxy into open spaces between and around all conductors.

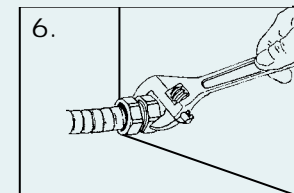

Insert cable and sleeve assembly into body. Tighten intermediate body and cap.

NEBT Series Protective Boots for CableReady® Connectors

For use with TMC and TMCX Connectors.

Applications

- Designed for use with Appleton®'s TMC or TMCX CableReady® Connectors.
- Cover the external surface of the connector, the area where cable enters the connector and the joint where the connector enters enclosure.
- Provide improved corrosion resistance in harsh environments and guard against the entry of moisture into the connector and enclosure.
- For use in horizontal and vertical runs.
- For use in non-hazardous or hazardous locations.

Features

- Simplified two piece construction design reduces installation time.

Size Range

- Ten boot sizes cover a cable jacket diameter range of .485 to 4.220 and connector trade sizes 1/2" to 4".

Standard Material

- Neoprene rubber.

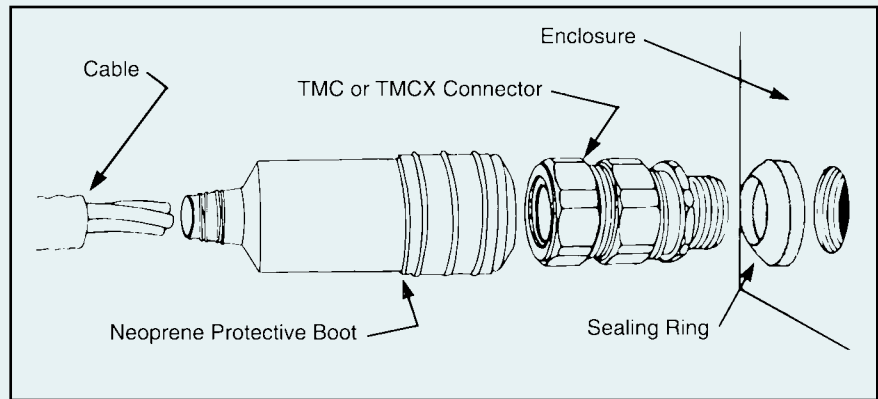

Boot Cat No.	Cable Jacket Range (In.)	Trade Size (In.)		Used With
NEBT50	.485 - .760	1/2	—	TMCX-6550
NEBT75	.700 - .990	3/4	—	TMCX-8875
NEBT100	.900 - 1.300	1	—	TMCX-118100
NEBT125	1.210 - 1.510	1-1/4	—	TMCX-140125
NEBT150	1.440 - 1.790	1-1/2	—	TMCX-166150
NEBT200	1.730 - 2.200	2	—	TMCX-206200
NEBT250	2.100 - 2.660	2-1/2	TMC-251250	or TMCX-251250
NEBT300	2.600 - 3.230	3	TMC-304300	or TMCX-304300
NEBT350	3.110 - 3.780	3-1/2	TMC-359350	or TMCX-359350
NEBT400	3.700 - 4.220	4	TMC-402400	or TMCX-402400