

FS and FD Cast Device Boxes

CSA Certification Only.

UNILETS® for use with Threaded Rigid Conduit and IMC. All device boxes have ridge top construction.

Applications

- Accommodate wiring devices such as switches and receptacles.
- Provide excellent service in areas where boxes are subject to rough usage.
- Serve as pull boxes for conductors.
- Permit access to conductors for maintenance.
- Provide openings for making splices.
- Allow connections for branch conduit runs.
- Blank bodies for special conduit entrance arrangements.

Features

- Corrosion-resistant — ideal for indoor and outdoor installations.
- Weatherproof, raintight and dust-tight when used with cast gasketed covers.
- FS and FD boxes take standard flush wiring devices.
- FD boxes take devices exceeding 1-5/8" in depth under fastening ears.
- Malleable iron for high tensile strength and ductility — provides greater resistance to impact and shock.
- Both malleable iron and aluminum boxes have ridge top construction for positive cover/gasket/box fit.
- Accurately tapped, tapered threads for tight, rigid joints, ground continuity.
- Complete selection of covers, receptacles, plugs, gaskets and accessories.
- Covers have captive stainless steel screws to speed installation, prevent "freezing" of screws.
- Ground screw at top of box for easy access.
- Cast Hub Boxes
 - Available in single, two, three and four gang and tandem.
 - Smooth, rounded integral bushing in each hub protects conductor insulation.
- FD Blank Bodies for Brazed Hubs or Drill and Tapped Entries
 - Available in single, two, three and four gang boxes.
 - Drill and tapped entries.
 - Brazed threaded hubs for threaded conduit from 1/2" thru 1-1/2" and brazed union hubs from 1/2" thru 1-1/4.
 - Smooth, rounded integral bushing in each hub protects conductor insulation.
 - Ground screw at top of box for easy access.

Standard Materials

- Cast hub device boxes and boxes for drilling and tapping: malleable iron or copperfree (4/10 of 1% max.) aluminum
- Brazed hubs: malleable iron
- Covers: malleable iron, steel, or copperfree (4/10 of 1% max.) aluminum

Standard Finishes

- Malleable iron boxes and covers: triple-coat — (1) zinc electroplate, (2) chromate, and (3) aluminum polymer enamel
- Aluminum boxes and covers: epoxy powder coat
- Steel covers: zinc electroplate
- Screws: stainless steel

Options

- Enclosures drilled for 347 Volt devices. Add suffix **-347**.



Gasket is designed so that it "wraps around" ridge top of Appleton aluminum or malleable iron device box. Result is a positive seal against moisture.

Certifications and Compliances

- CSA Standard: C22.2 No. 18.1
- CSA Certified: 001472

Reference Data

- When ordering drilled and tapped openings or brazed hubs for blank bodies, refer to *FS and FD Cast Device Boxes Drilling and Tapping Information*  pages.

 CSA Certification Only.

FS and FD Single-Gang Cast Device Boxes

CSA Certification Only.

UNILETS® for use with Threaded Rigid Conduit and IMC. All device boxes have ridge top construction.

	Size		Malleable Iron			Aluminum	
			Catalog Number	Wt. Lbs./Kgs.		Catalog Number	Wt. Lbs./Kgs.
	1/2		FS-1	1.94/0.88		FS-1A	0.64/0.29
	3/4	Shallow	FS-2	2.25/1.02	Shallow	FS-2A	0.75/0.34
	1		FS-3	1.94/0.88		FS-3A	0.64/0.29
	1/2		FD-1	2.70/1.22		FD-1A	0.90/0.41
	3/4	Deep	FD-2	2.60/1.18	Deep	FD-2A	0.92/0.42
	1		FD-3	2.80/1.27		FD-3A	0.94/0.43
	1/2	Shallow	FSA-1	1.70/0.77	Shallow	FSA-1A	0.57/0.26
	3/4		FSA-2	1.60/0.73		FSA-2A	0.58/0.26
	1/2	Deep	FDA-1	2.10/0.95	Deep	FDA-1A	0.70/0.32
	3/4		FDA-2	2.00/0.91		FDA-2A	0.67/0.30
	1/2		FSC-1	2.10/0.95		FSC-1A	0.70/0.32
	3/4	Shallow	FSC-2	2.40/1.09	Shallow	FSC-2A	0.80/0.36
	1		FSC-3	2.06/0.93		FSC-3A	0.70/0.32
	1/2		FDC-1	2.80/1.27		FDC-1A	0.94/0.43
	3/4	Deep	FDC-2	2.80/1.27	Deep	FDC-2A	0.94/0.43
	1		FDC-3	3.00/1.36		FDC-3A	1.00/0.45
	1/2	Shallow	FSCC-1	1.70/0.77	Shallow	FSCC-1A	0.57/0.26
	3/4		FSCC-21 *	2.20/0.99		FSCC-21A *	0.74/0.34
	1/2		FSCT-1	2.50/1.13		FSCT-1A	0.84/0.38
	3/4	Shallow	FSCT-2	2.50/1.13	Shallow	FSCT-2A	0.84/0.38
	1		FSCT-3	2.25/1.02		FSCT-3A	0.75/0.34
	1/2		FDCT-1	3.00/1.36		FDCT-1A	1.00/0.45
	3/4	Deep	FDCT-2	2.80/1.27	Deep	FDCT-2A	0.94/0.43
	1		FDCT-3	3.10/1.41		FDCT-3A	1.03/0.47
	1/2	Deep	FDD-1	2.20/0.99	Deep	FDD-1A	0.74/0.34
	3/4		FDD-2	2.30/1.04		FDD-2A	0.77/0.35
	3/4	Shallow	FSL-2	2.34/1.06	Shallow	FSL-2A	0.78/0.35

* Use FD Unilets for wiring devices exceeding 1-5/8" in depth under fastening ears.

† CSA Certification Only.



Fittings

FITTINGS: CAST DEVICE BOXES

FS and FD Single Gang Cast Device Boxes

CSA Certification Only.

UNILETS® for use with Threaded Rigid Conduit and IMC. All device boxes have ridge top construction.

	Size	Malleable Iron		Aluminum			
		Catalog Number	Wt. Lbs./Kgs.	Catalog Number	Wt. Lbs./Kgs.		
	1/2	Shallow	FSS-1	1.80/0.82	Shallow	FSS-1A	0.60/0.27
	3/4		FSS-2	1.80/0.82		FSS-2A	0.60/0.27
	1/2	Shallow	FST-1	2.46/1.12	Shallow	FST-1A	0.82/0.37
	3/4		FST-2	2.33/1.06		FST-2A	0.78/0.35
	1	Deep	FDT-3	3.20/1.45	Deep	FDT-3A	1.07/0.49
	1/2	Shallow	FSX-1	2.75/1.25	Shallow	FSX-1A	0.91/0.41
	3/4		FSX-2	2.34/1.06		FSX-2A	0.78/0.35
	1/2	Deep	FDX-1	3.10/1.41	Deep	FDX-1A	1.03/0.47
	3/4		FDX-2	3.00/1.36		FDX-2A	1.06/0.48
	1		FDX-3	3.50/1.59		FDX-3A	1.17/0.53

Dimensions in Inches/Millimeters

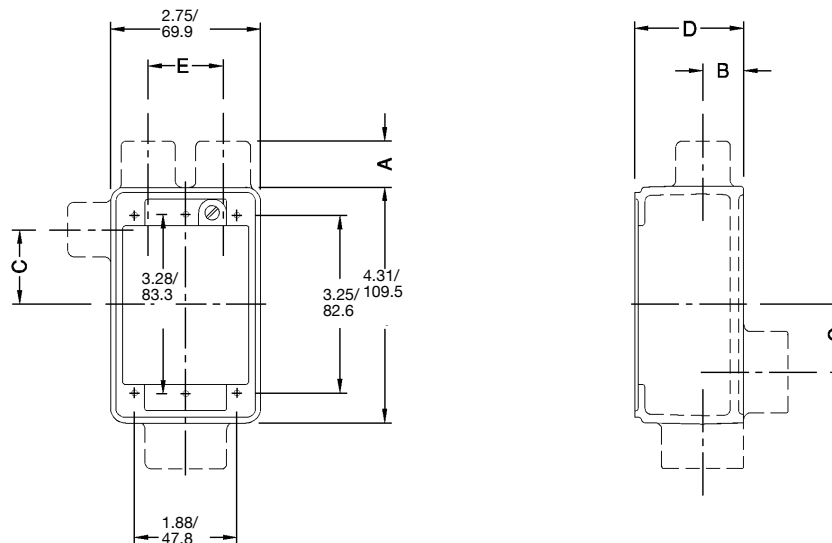

FS & FD Single Gang Devices









Hub Size	A	B	C	D		E
				FS	FD	
1/2	0.75/0.3	0.63/0.3	1.38/0.6	2.00/0.9	2.75/1.3	1.38/0.6
3/4	0.75/0.3	0.75/0.3	1.38/0.6	2.00/0.9	2.75/1.3	1.38/0.6
1	0.88/0.4	0.88/0.4	1.25/0.8	2.00/0.9	2.75/1.3	1.38/0.6

 CSA Certification Only.

FS and FD Single Gang Cast Device Boxes

CSA Certification Only.

UNILETS® for use with Threaded Rigid Conduit and IMC.

	Description	Catalog Number	Wt. Lbs./Kgs. Per 100
Single Gang Covers			
	Blank Cover, Steel — Zinc Electroplate	FS-4 *	12.00/5.44
	Round Receptacle Cover, Steel — Zinc Electroplate Hole dia. 1-7/16"	FS-5 *	12.00/5.44
	Duplex Receptacle Cover, Steel — Zinc Electroplate	FS-6 *	10.00/4.54
	Round Receptacle Cover, Steel — Zinc Electroplate Hole dia. 1-5/8"	FS-8 *	12.00/5.44
	Tumbler Switch Cover, Steel — Zinc Electroplate	FS-9 *	12.00/5.44
	Tumbler Switch Cover, Steel — Zinc Electroplate	FSK-ITS-G †	22.00/9.98
	For pilot lamp Red Jewel Amber Jewel Green Jewel Opal Jewel	FSK-1J † FSK-1JA † FSK-1JG † FSK-1JO †	25.00/11.34
Single Gang Weatherproof Covers			
	Blank Cover, Malleable Iron, Zinc Electroplate	FS-100G	56.00/25.40

Fittings

FITTINGS: CAST DEVICE BOXES

* Available in Aluminum: Add suffix **-A** to Catalog Number.











† Also for use with multiple gang Unilets with individual cover openings.

 CSA Certification Only.

FS and FD Single Gang Cast Device Boxes

CSA Certification Only.

UNILETS® for use with Threaded Rigid Conduit and IMC.

Description	Catalog Number	
	Malleable Iron Ridge Top	Aluminum Ridge Top
Cast Covers Only — Weatherproof — Furnished with gasket and stainless steel screws		
 Receptacle cover with spring cover. Hole Diameter — 1-7/16"	FSK-1VRCN	—
 Rocker type for square handle tumbler or toggle switches	FSK-1VCN	FSK-1V-ACN
 For duplex flush receptacle with spring cover	FSK-1VDR	FSK-1VDR-A
 For external operation of tumbler switches with square handles	FSK-1VTSCN	FSK-1VTSACN
 Operating type for square handle tumbler or toggle switches	FSK-1VSCN	FSK-1VS-ACN
Gasket — Replacement		
 Neoprene — for use with cast	FS-GKR-1N	FS-GKR-1N
Cast Covers Only — Furnished with stainless steel screws less gasket		
 For standard 2 or 3 wire duplex receptacles	FSK-1DR-CCN	—
 For round flush receptacles. Hole dia. 1-7/16"	FSK-1R-ZCN	—
 For square handle toggle switches	FSK-1TS-CCN	—
 For square handle toggle switches (with protecting guard)	FSA-1TSG-CCN	FSK-1TSG-CACN

Fittings

FITTINGS: CAST DEVICE BOXES

 CSA Certification Only.

FS and FD Receptacle Covers and Plugs for Single Gang Device Boxes

CSA Certification Only. Weatherproof, Raintight and Dust-tight

Covers for Ridge Top Boxes.



Receptacle	Plug	Pole/Wire	Catalog Number		
			Receptacles Malleable Iron Ridge Top	Aluminum Ridge Top	Plug

Receptacle cover has threaded aluminum cap. Plug has neoprene boot and aluminum fastening ring. Furnished with receptacle, neoprene gasket, stainless steel screws.



Non-Locking, "U" Shaped Grounding Type – Receptacle takes "U" shaped or round grounding contact plugs

15 Amp, 125V





NEMA 5-15R 	NEMA 5-15P 	2P, 3W	FSK5-15	FSK5-15-A	FSWP5-15
--	--	--------	----------------	------------------	-----------------

20 Amp, 125V



NEMA 5-20R 	NEMA 5-20P 	2P, 3W	FSK5-20 †	FSK5-20-A †	FSWP5-20
--	--	--------	------------------	--------------------	-----------------

15 Amp, 250V



NEMA 6-15R 	NEMA 6-15P 	2P, 3W	FSK6-15	FSK6-15-A	FSWP6-15
--	--	--------	----------------	------------------	-----------------

20 Amp, 250V

NEMA 6-20R 	NEMA 6-20P 	2P, 3W	FSK6-20 ‡	FSK6-20-A	FSWP6-20
--	--	--------	------------------	------------------	-----------------

Locking Grounding Type

15 Amp, 125V



NEMA L5-15R 	NEMA L5-15P 	2P, 3W	FSKL5-15		FSWPL5-15
---	---	--------	-----------------	--	------------------

15 Amp, 250V

NEMA L6-15R 	NEMA L6-15P 	2P, 3W	FSKL6-15		FSWPL6-15
---	---	--------	-----------------	--	------------------

15 Amp, 277V



NEMA L7-15R 	NEMA L7-15P 	2P, 3W	FSKL7-15		FSWPL7-15
---	---	--------	-----------------	--	------------------

† Also takes FSWP5-15 Plugs.

‡ Also takes FSWP6-15 Plugs.

✦ CSA Certification Only.



FITTINGS: CAST DEVICE BOXES

Fittings

FS and FD Two Gang Cast Device Boxes

CSA Certification Only.

UNILETS® for use with Threaded Rigid Conduit and IMC. All device boxes have ridge top construction.

	Size		Gray Iron			Aluminum	
			Catalog Number	Wt. Lbs./Kgs.		Catalog Number	Wt. Lbs./Kgs.
	1/2	Shallow	FS-12	2.70/1.22	Shallow	FS-12A	0.90/0.41
	3/4		FS-22	2.60/1.18		FS-22A	0.87/0.39
	1/2	Deep	FD-12	2.70/1.22	Shallow	FD-12A	0.90/0.41
	3/4		FD-22	2.70/1.22		FD-22A	0.90/0.41
	1		FD-32	2.80/1.27		FD-32A	0.93/0.42
		1/2	Shallow	FSC-12	3.00/1.36	Shallow	FSC-12A
3/4		FSC-22		3.00/1.36	FSC-22A		1.00/0.45
1/2		Deep	FDC-12	2.90/1.32	Deep	FDC-12A	0.97/0.44
3/4			FDC-22	3.00/1.36		FDC-22A	1.06/0.48
1			FDC-32	3.10/1.41		FDC-32A	1.03/0.47
		1/2 - 3/4	Shallow	FSD-212 *	2.70/1.22	Shallow	FSD-212A *

Dimensions in Inches/Millimeters

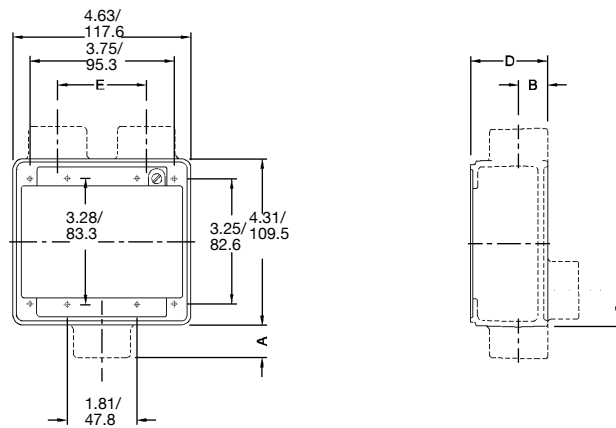

FS & FD Two-Gang Devices

Hub Size	A	B	C	D		E
				FS	FD	
1/2	0.75/19.1	0.63/16.0	1.38/35.1	2.00/50.8	2.75/69.9	2.31/58.7
3/4	0.75/19.1	0.75/19.1	1.38/35.1	2.00/50.8	2.75/69.9	2.31/58.7
1	0.88/22.4	0.88/22.4	1.25/31.8	2.00/50.8	2.75/69.9	2.31/58.7









* Hubs at top of illustration are 1/2".

 CSA Certification Only.

FS and FD Two Gang Cast Device Boxes

CSA Certification Only.

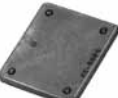
UNILETS® for use with Threaded Rigid Conduit and IMC.

	Description	Catalog Number	Wt. Lbs./Kgs. Per 100
Two Gang Covers			
	Blank Cover, Steel – Zinc Electroplate	FS-42 *	20.00/9.07
	Round Receptacle Cover, Steel – Zinc Electroplate Hole dia. 1-7/16"	FS-52 *	18.00/8.16
	Duplex Receptacle Cover, Steel-Zinc Electroplate	FS-62 *	15.00/6.80
	Tumbler Switch Cover, Steel –Zinc Electroplate	FS-92 *	20.00/9.07
	Combination Duplex Receptacle and Tumbler Switch Cover, Steel - Zinc Electroplate	FS-69 *	15.00/6.80
	Combination Duplex Receptacle and Single Receptacle, Steel - Zinc Electroplate	FS-65 *	15.00/6.80
Weatherproof Covers			
	Blank Cover, Gray Iron	FS-200G *	56.00/25.40
	For external operation of tumbler switches with square handles	FSK-2VTS	250.00/113.40
Gasket – Replacement			
	Neoprene - for use with 2-gang cast covers above	FS-GKR-2N	—

* Available in Aluminum: Add suffix **-A** to catalog number.

 CSA Certification Only.

FS and FD Three Gang Cast Device Boxes

CSA Certification Only.

UNILETS® for use with Threaded Rigid Conduit and IMC. All device boxes have ridge top construction.

Size	Gray Iron		Aluminum	
	Catalog Number	Wt. Lbs./Kgs.	Catalog Number	Wt. Lbs./Kgs.

FS Three Gang Bodies



3/4	Shallow	FSC-23	3.60/1.63	Shallow	FSC-23A	1.20/0.54
1	Deep	FDC-33	4.00/1.81	Deep	FDC-33A	1.33/0.60

Description	Catalog Number	Wt. Lbs./Kgs. Per 100
-------------	----------------	-----------------------

Three Gang Covers



Duplex Receptacle Cover, Steel – Zinc Electroplate **FS-63 *** 23.00/10.43



Tumbler Switch, Steel –Zinc Electroplate **FS-93 *** 25.00/11.34

Weatherproof Covers



Blank Cover, Gray Iron **FS-300G *** 120.00/54.43



For external operation of tumbler or toggle switches with square handles **FSK-3VTS** 330.00/149.69

Dimensions in Inches/Millimeters

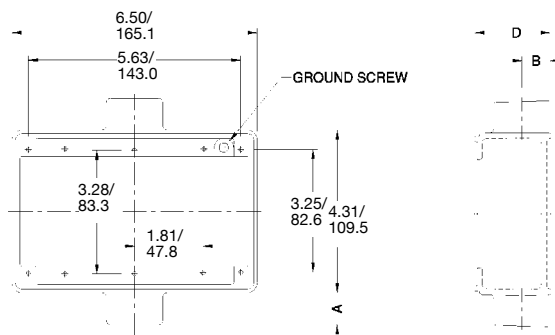

Three Gang Devices

Hub Size	D					
	A	B	C	FS	FD	E
1/2	0.75/ 19.1	0.63/ 16.0	1.38/ 35.1	2.00/ 50.8	2.75/ 69.9	2.19/ 55.6
1	0.88/ 22.4	0.88/ 22.4	1.25/ 31.8	2.00/ 50.8	2.75/ 69.9	2.19/ 55.6

* Available in Aluminum: Add suffix -A to catalog number.

 CSA Certification Only.

FS and FD Cast Device Boxes

CSA Certification Only.

UNILETS® for use with Threaded Rigid Conduit and IMC. All device boxes have ridge top construction.

Features

- Thick wall on all four sides.
- Drill and tap anywhere on sidewalls.
- Ground screw at top of box for easy access.
- Two exterior mounting lugs.
- Fits standard sheet metal device covers with four mounting holes.
- Weatherproof when used with gasketed cast weatherproof device covers.

Standard Finishes

- Malleable iron: triple-coat — (1) zinc electroplate, (2) chromate, and (3) aluminum polymer enamel
- Aluminum: epoxy powder coat

Reference Data

- When ordering drilled and tapped openings or brazed hubs for blank bodies, refer to *FS and FD Cast Device Boxes Drilling and Tapping Information*  page.

Standard Materials

- Malleable iron or copperfree (4/10 of 1% max.) aluminum

Description	Catalog Number	
	Gray Iron	Aluminum

FDO Unilets with Lugs: FD depth 2-19/32" — Maximum hub size 1-1/2" threaded, and 1-1/4" no-thread or union.

	Single-Gang	FD0-1	FD0-1A
	Two-Gang	FD0-2	FD0-2A
	Three-Gang	FD0-3	FD0-3A
	Four-Gang	FD0-4	FD0-4A

FD Unilets with Lugs: FD depth 2.69" — Takes single gang covers

	Single-Gang	FD-1L	—
	Two-Gang	FD-2L	—
	Three-Gang	FD-3L	—
	Four-Gang	FD-4L	—

 CSA Certification Only.

FS and FD Cast Device Boxes

CSA Certification Only.

UNILETS® for use with Threaded Rigid Conduit and IMC. All device boxes have ridge top construction.

Dimensions in Inches/Millimeters

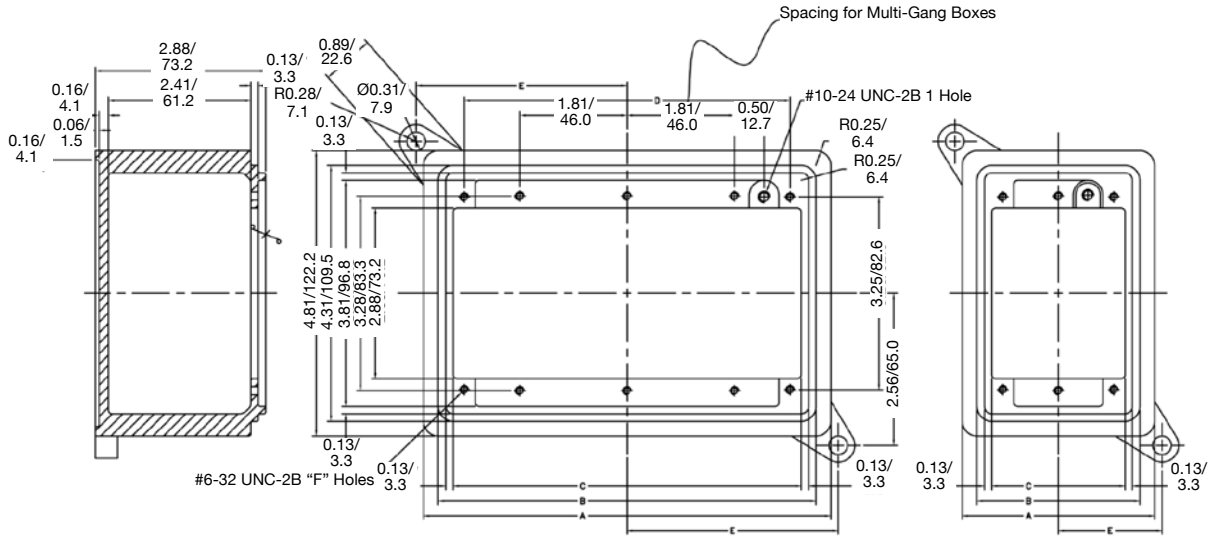

FDO Unilets

No. of Gangs	A	B	C	D	E	F
1	3.25/82.6	2.75/69.9	2.31/58.67	1.88/47.8	1.75/44.5	6.00/152.4
2	5.13/130.3	4.63/117.6	4.19/106.4	3.75/95.3	2.69/68.3	8.00/203.2
3	7.00/177.8	6.50/165.1	6.06/154.0	5.63/143.0	3.63/92.2	10.00/254.0
4	8.88/225.6	8.38/212.9	7.94/201.7	7.50/190.5	4.56/115.8	12.00/304.8

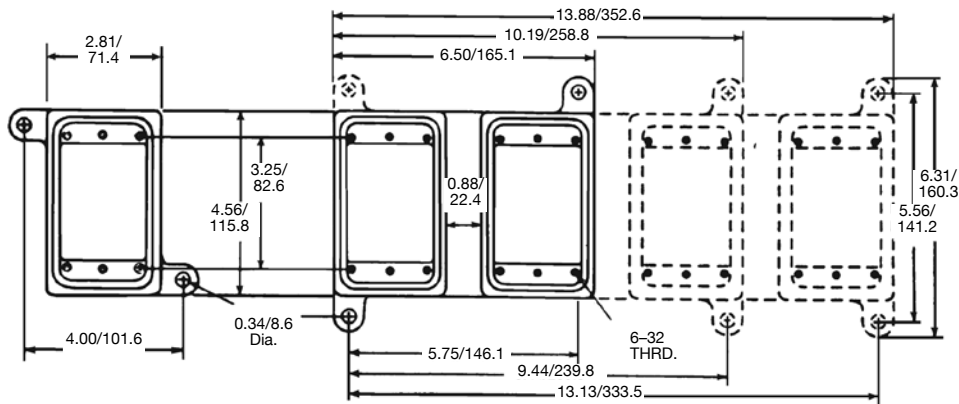

FD Unilets with Lugs

 CSA Certification Only.

FS and FD Cast Device Boxes Drilling and Tapping Information

CSA Certification Only. Malleable Iron, Aluminum

UNILETS® for use with Threaded Rigid Conduit and IMC. All device boxes have ridge top construction.

Hub Information

Listed below are the various types of brazed hubs which may be used with the FD Unilets and the FDO box. Threaded, no-thread and union hubs may be brazed at any desired location.

It is possible to place more than five hubs on the top and bottom of three and four-gang Unilets.

Look at the chart below for the maximum hub diameter and the minimum hub spacing distance. This chart, together with the Unilet dimensions will enable you to figure the maximum number of hubs which may be used.

The hubs will be symmetrically placed about the axis of the Unilets unless exact dimensions are specified on the order.

	Size	Threaded for Rigid Conduit	No Thread for Rigid Conduit	No Thread for Electrical Metallic Tubing	Union
Maximum Hub Size	FS	1	3/4	3/4	3/4
	FD	1-1/2	1-1/4	1-1/4	1-1/4
Maximum Hub Diameter	1/2	1-1/8	1-1/2	1-1/8	1-1/2
	3/4	1-3/8	1-25/32	1-3/8	1-25/32
	1	1-9/16	2-1/32	1-9/16	2-1/32
	1-1/4	1-15/16	2-25/32	1-15/16	2-25/32
	1-1/2	2-3/16	—	—	—
Maximum Distance Between Conduit Centers	1/2	1-1/4	1-9/16	1-1/4	1-9/16
	3/4	1-1/2	1-27/32	1-1/2	1-27/32
	1	1-3/4	2-3/32	1-3/4	2-3/32
	1-1/4	2-1/8	2-29/32	2-1/8	2-29/32
	1-1/2	2-3/8	—	—	—

Fittings

FITTINGS: CAST DEVICE BOXES

 CSA Certification Only.

FS and FD Cast Device Boxes Drilling and Tapping Information

CSA Certification Only. Malleable Iron, Aluminum

UNILETS® for use with Threaded Rigid Conduit and IMC. All device boxes have ridge top construction.

Ordering Data

To determine the catalog numbers of Unilets with drilled and tapped entries or hubs, the following information should be shown:

1. Unilet catalog number.
2. Sketch number of entry arrangement selected from illustrations below.
3. Entry symbols taken from the table right. Start from the left on the top of the Unilet and continue in rotation clockwise around its body. Where no entry is required, the symbol X should be inserted. The three various divisions of the catalog number should be separated by dashes.

Ordering Example:

The Unilet selected is an FDO4 and the entry arrangement is sketch number 12. Entry A, B and C are to be 1/2" drilled and tapped for rigid conduit; D is to be a 1" hub and there is no entry at location E. The catalog number will be as follows FDO4-12-111CX.

Symbol Table

Hub Size (inches)	Brazed Threaded Hub Symbol	Brazed Union Hub Symbol
Blank	X	X
1/2	1	A
3/4	2	B
1	3	C
1-1/4	4	D
1-1/2	5	E
2	6	F

Single, Two, Three and Four-Gang — Front view and oriented as mounted

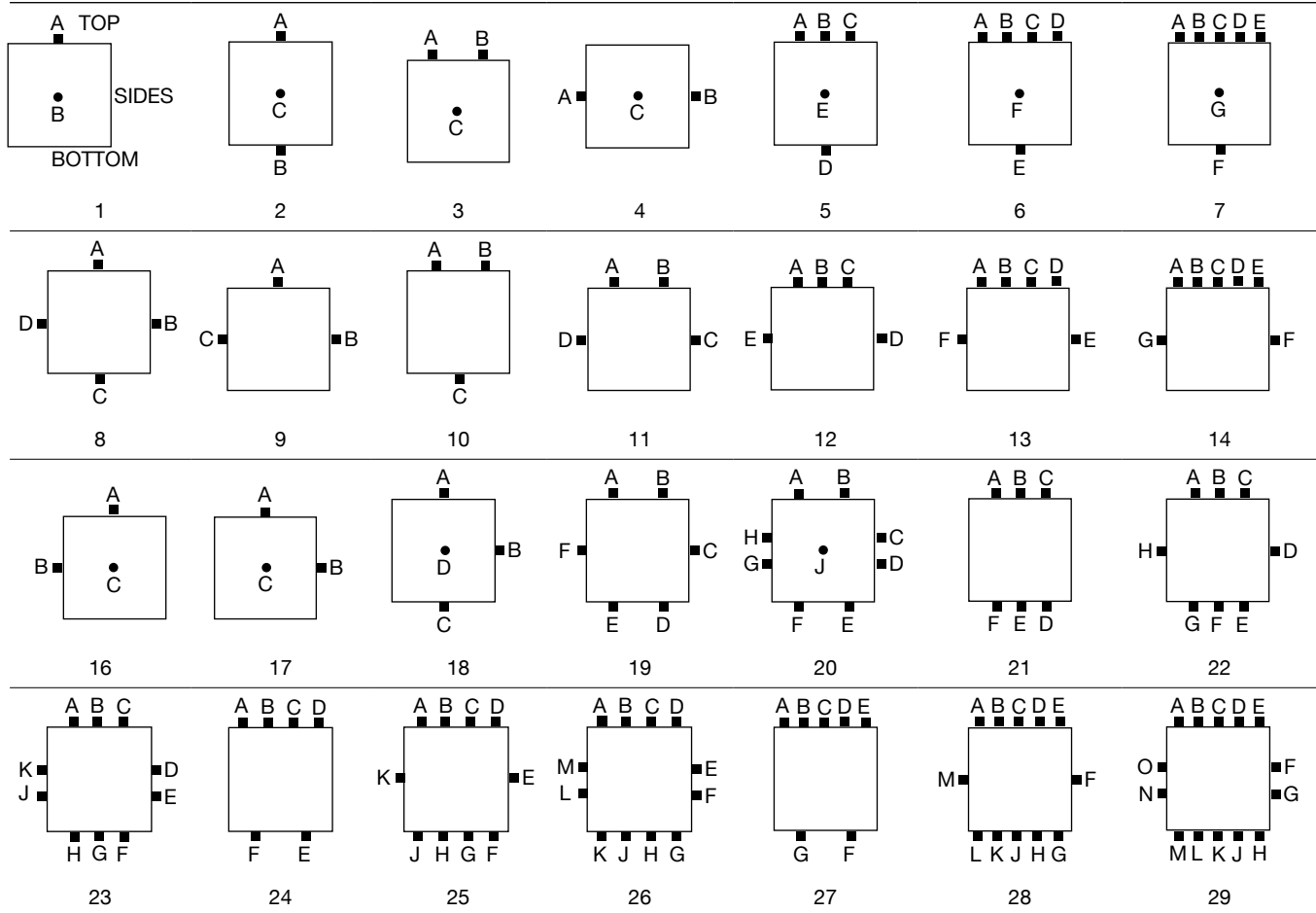

 CSA Certification Only.