

**162**  
Series

**papco**® **RAPID REPAIR WASHERS**  
**RONDELLES REPARATION RAPIDE**

Convenient skin-packed card includes two (2) Rapid Repair Washers. Order by Card Number



Card No.  
162-766

Card No.	Shaft Dia.	Card No.	Shaft Dia.
162-762	3/4	162-772	1-3/8
162-764	7/8	162-774	1-1/2
162-766	1"	162-778	1-3/4
162-768	1-1/8	162-782	2"
162-770	1-1/4		

**RAPID REPAIR WASHER ASSORTMENT No. 020-876**

Includes 9 sizes of carded Rapid Repair Washers in sizes 3/4" to 2" — 30 cards in all, plus peg-board hooks and attractive three-colour point of purchase signs.



**162**  
Series

**papco**® **BRASS WASHERS**  
**RONDELLES LAITON**

"PAPCO" BRASS WASHERS are free from burrs and have bright, smooth, flat surfaces.

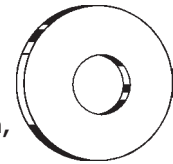

Small or large patterns available from No. 6 to 3/8".

Order by Stock Number

Stock No.	Screw or Bolt Size	I.D.	O.D.	Thick.	Std. Pkg.	Stock No.	Screw or Bolt Size	I.D.	O.D.	Thick.	Std. Pkg.
162-802	#2	.092	7/32	.018	100	162-815	1/4	.260	11/16	.051	100
162-803	#3	.105	1/4	.020	100	162-816	5/16	.337	3/4	.064	100
162-804	#4	.119	9/32	.025	100	162-817	5/16	.337	7/8	.064	100
162-805	#5	.133	9/32	.025	100	162-818	3/8	.391	7/8	.064	100
162-806	#6	.147	5/16	.028	100	162-819	3/8	.391	1	.081	100
162-807	#6	.147	3/8	.032	100	162-820	7/16	1/2	1-1/8	.081	50
162-808	#8	.172	3/8	.032	100	162-822	1/2	9/16	1-1/4	.091	50
162-809	#8	.172	7/16	.036	100	162-823	9/16	5/8	1-1/2	.091	25
162-810	#10	.200	7/16	.036	100	162-824	5/8	11/16	1-1/2	.102	25
162-811	#10	.200	1/2	.040	100	162-826	3/4	13/16	1-7/8	.114	20
162-812	#12	.227	1/2	.040	100	162-828	7/8	15/16	2-1/4	.128	20
162-813	#12	.227	9/16	.040	100	162-830	1	1-1/16	2-1/2	.144	20
162-814	1/4	.260	9/16	.040	100						

**BRASS WASHER GARAGE ASSORTMENT No. 020-056**

Contains 100 Brass Washers in popular sizes from No. 10 to 1/2". Packed in a clear plastic box with hinged lid.



**COPPER WASHER GARAGE ASSORTMENT No. 020-083**

Contains 100 Copper Washers in six sizes from No. 10 to 1/2". Packed in a transparent plastic box with hinged lid.

**162**  
Series

**papco**® **COPPER WASHERS**  
**RONDELLES CUIVRE**

"PAPCO" soft Copper Washers are used as gaskets and have bright, smooth, flat surfaces.



Order by Stock Number

Stock No.	Bolt Size	I.D.	O.D.	Thick.	Std. Pkg.	Stock No.	Bolt Size	I.D.	O.D.	Thick.	Std. Pkg.
162-860	#10	7/32	1/2	1/16	100	162-868	3/8	13/32	13/16	1/16	100
162-864	1/4	9/32	5/8	1/16	100	162-870	7/16	15/32	59/64	1/16	50
162-866	5/16	11/32	11/16	1/16	100	162-872	1/2	17/32	1-1/16	3/32	50

For Copper Drain Plug Gaskets see page 129.

**162**  
Series

**papco**® **RAPID REPAIR WASHERS**  
**RONDELLES REPARATION RAPIDE**



'Papco' Steel Spacer Washers are made from Cold Rolled Steel. All Spacer Washers are 1/32" thick.

Order by Stock Number

Stock No.	Hole Size	O.D.	Std. Pckg.	Stock No.	Hole Size	O.D.	Std. Pckg.	Stock No.	Hole Size	O.D.	Std. Pckg.
162-910	3/16	1/2	100	162-925	11/16	1-1/16	100	162-936	1-3/8	2"	50
162-914	1/4	9/16	100	162-926	3/4	1-1/8	100	162-938	1-1/2	2-1/4	50
162-916	5/16	5/8	100	162-927	13/16	1-1/4	100	162-940	1-5/8	2-3/8	25
162-918	3/8	3/4	100	162-928	7/8	1-3/8	100	162-942	1-3/4	2-1/2	25
162-920	7/16	13/16	100	162-930	1"	1-1/2	50	162-944	2	2-3/4	25
162-922	1/2	7/8	100	162-932	1-1/8	1-5/8	50	162-946	2-1/8	3"	25
162-923	9/16	1"	100	162-934	1-1/4	1-7/8	50	162-948	2-1/4	3-1/4	25
162-924	5/8	1"	100								

**SPACER WASHER**

**GARAGE ASSORTMENT No. 020-058**

Contains 125 Steel Spacer Washers all 1/32" thick in sizes from 1/4" to 1-1/2". Packed in a transparent, plastic box.



**papco**® **SPRING TENSION WASHERS**

These heat treated spring steel washers are used to eliminate rattles in rods and connecting levers and to take up side play and lost motion in carburetor linkage, clevis yokes, brake shoe pins and gear shift rods etc.



Order by Stock Number

Stock No.	Shaft Dia.
162-963	3/16
162-964	1/4
162-965	5/16
162-966	3/8
162-967	7/16
162-968	1/2

**SPRING TENSION WASHER**  
**UTILITY ASSORTMENT**  
**No. 020-351**

Contains 210 Tension Washers. 35 each of six sizes in a sturdy, fibreboard container with individual compartments.



Standard Package 100 pieces.

**papco**® **COUNTERSUNK FINISHING WASHERS**



Standard Type

"PAPCO" Countersunk Finishing Washers are made from sheet brass and nickel plated. Used in body trim work with countersunk head screws and bolts.



Flush Type

Standard Package 100 Washers

COUNTERSUNK STANDARD TYPE			
Stock No.	Screw Size	Inside Dia.	Outside Dia.
162-971	#6	.167	7/16
162-973	#8	.193	1/2
162-975	#10	.228	19/32
162-977	#12	.291	11/16
162-979	1/4	.318	25/32
COUNTERSUNK FLUSH TYPE			
162-988	#8	13/64	13/32
162-990	#10	13/64	15/32
162-994	1/4	17/64	5/8

**papco**® **FINISHING WASHER**  
**GARAGE ASSORTMENT**  
**No. 020-030**

Contains 200 Nickel Plated Finishing Washers used with Countersunk Head Screws.

Sizes from No. 6 to 1/4".

Packed in a sturdy, clear plastic container.



# papeo® STOVE BOLTS BOULONS DE POELE



**195**  
Flat

FLAT HEAD



BRIGHT  
PLATED

ROUND HEAD



**196**  
Round



BRIGHT ELECTRO PLATED

Order by Stock Number

Standard Package 100 Bolts and Nuts.

Stock Numbers			Stock Numbers			Stock Numbers			Stock Numbers		
Flat	Round	Size	Flat	Round	Size	Flat	Round	Size	Flat	Round	Size
195-087	196-087	1/8 x 1/2	195-195	196-195	3/16 x 1-1/4	195-307	196-307	1/4 x 3/4	195-444	196-444	5/16 x 1
195-089	196-089	1/8 x 3/4	195-197	196-197	3/16 x 1-1/2	195-309	196-309	1/4 x 1	195-448	196-448	5/16 x 1-1/2
195-091	196-091	1/8 x 1	195-199	196-199	3/16 x 1-3/4	195-311	196-311	1/4 x 1-1/4	195-451	196-451	5/16 x 2
195-093	196-093	1/8 x 1-1/4	195-200	196-200	3/16 x 2	195-313	196-313	1/4 x 1-1/2	195-453	196-453	5/16 x 2-1/2
195-095	196-095	1/8 x 1-1/2	195-202	196-202	3/16 x 2-1/2	195-315	196-315	1/4 x 1-3/4	195-455	196-455	5/16 x 3
195-189	196-189	3/16 x 1/2	195-204	196-204	3/16 x 3	195-316	196-316	1/4 x 2	195-493	196-493	3/8 x 1-1/2
195-191	196-191	3/16 x 3/4	195-305	196-305	1/4 x 1/2	195-317	196-317	1/4 x 2-1/4	195-496	196-496	3/8 x 2
195-193	196-193	3/16 x 1	195-306	196-306	1/4 x 5/8	195-318	196-318	1/4 x 2-1/2	195-498	196-498	3/8 x 2-1/2
						195-320	196-320	1/4 x 3	195-500	196-500	3/8 x 3

For Slot Drive Stove Bolts see current Price Book.

## papeo® STOVE BOLTS ASSORTMENTS ASSORTIMENTS DE BOULONS DE POELE

### GARAGE ASSORTMENT No. 020-044 ROUND HEAD

Contains 68 Stove Bolts from  
3/16" x 1/2" to 1/4" x 2".



### GARAGE ASSORTMENT No. 020-045 FLAT HEAD

Contains 68 Stove Bolts from  
3/16" x 1/2" to 1/4" x 2".

Packed in rigid, transparent, plastic containers

### STOVE BOLT UTILITY ASSORTMENT No. 020-324

Contains 200 Round Head Stove Bolts, from  
3/16" x 1/2" to 1/4" x 2".

### UTILITY ASSORTMENT No. 020-323

Contains 80 Round Head Stove Bolts, 6 sizes:  
3/16" x 4", 5", 6";  
1/4" x 4", 5", 6".

These assortments are packed in sturdy fibreboard  
containers. Each size is in a separate compartment.  
Retail prices are shown on lid label. Assortment can  
be refilled from Standard Packages.



#### STOVE BOLT and MACHINE SCREW EQUIVALENT SIZES

STOVE BOLT DIAMETER	1/8"	5/32"	3/16"	1/4"	5/16"	3/8"
MACHINE SCREW SIZE	6-32	8-32	10-24	1/4-20	5/16-18	3/8-16

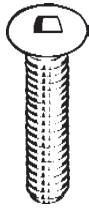

**174**  
Round

# papco<sup>®</sup> MACHINE SCREWS VIS DE MECANIQUE

‘LOXXON’ SQUARE SOCKET DRIVE  
BRIGHT ELECTRO PLATED

“PAPCO” MACHINE SCREWS are used on window moulding, door handles, instrument panels, lamp rims and many other applications.



**176**  
Flat

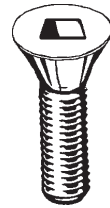

Order by Stock Number

Standard Package 100 pieces.

"Papco" Stock Number		Screw Dia.	Threads per Inch	Screw Length	Decimal Equiv. of Dia.	"Papco" Stock Number		Screw Dia.	Threads per Inch	Screw Length	Decimal Equiv. of Dia.
Round	Flat					Round	Flat				
174-039		4	40	1/4	.112"	174-189	176-189	10	24	1/2	.190"
174-043				1/2		3/4					
174-083		6	32	1/4	.138"	174-193	176-193	10	32	1	.190"
174-085	176-085			3/8		1-1/4					
174-087	176-087			1/2		1-1/2					
174-089	176-089			3/4							
174-091	176-091			1							
174-093	176-093			1-1/4							
174-095	176-095			1-1/2							
174-133				1/4							
174-135	176-135	3/8									
174-137	176-137	1/2									
174-139	176-139	8	32	3/4	.164"	174-213		10	32	1/4	.190"
174-141	176-141			1		3/8					
174-143	176-143			1-1/4		1/2					
174-145	176-145			1-1/2		3/4					
174-185				1/4		1					
174-187	176-187	3/8	1-1/4	174-217	176-217	1/2		1/4	20	1-1/4	.250"
				174-219	176-219	3/4					
				174-221	176-221	1					
				174-223	176-223	1-1/4					
				174-225	176-225	1-1/2					
								1/4	20	1/2	.250"

For Slot Drive Machine Screws see current Price Book.

**184**  
Series

# papco<sup>®</sup> HEX MACHINE SCREW NUTS ECROUS DE VIS DE MECANIQUE

BRIGHT ELECTRO PLATED



Order by Stock Number

Standard Package 100 pieces.

"Papco" Stock No.	Size	Threads per Inch	Dimensions		"Papco" Stock No.	Size	Threads per Inch	Dimensions	
			Across Flats	Thickness				Across Flats	Thickness
184-004	4	40	1/4	3/32	184-011	10	32	3/8	1/8
184-005	5	40	5/16	7/64	184-012	12	24	7/16	5/32
184-006	6	32	5/16	7/64	184-014	1/4	20	7/16	3/16
184-008	8	32	11/32	1/8	184-015	1/4	28	7/16	3/16
184-010	10	24	3/8	1/8					

# papco<sup>®</sup> MACHINE SCREWS ASSORTMENTS ASSORTIMENTS VIS DE MECANIQUE

‘LOXXON’ SQUARE SOCKET DRIVE

**GARAGE ASSORTMENT  
No. 020-010**

Round Head

Contains 130 Round Head Plated Machine Screws in various sizes and 45 Hexagon Plated Nuts.



**GARAGE ASSORTMENT  
No. 020-011**

Flat Head

Contains 130 Flat Head Plated Machine Screws in various sizes and 45 Hexagon Plated Nuts.

Packed in rigid, transparent, plastic containers.

# MACHINE SCREW ASSORTMENTS ASSORTIMENTS DE VIS DE MECANIQUE



## UTILITY ASSORTMENT No. 020-331

Round Head Square Drive Machine Screws.

Contains 320 Round Head Machine Screws and Nuts.  
16 sizes from 4-40 x 1/2" to 10-32 x 1-1/2".

## UTILITY ASSORTMENT No. 020-333

Flat Head Square Drive Machine Screws.

Contains 350 Flat Head Machine Screws and Nuts.

Screws – 6-32 x 3/8, 8-32" to 1/4" x 1-1/2".  
Nuts – 6-32, 8-32, 10-24, 1/4".

These assortments are packed in sturdy fibreboard metal edged boxes with individual compartments and with illustrated labels showing parts and retail codes.



Metal Merchandiser with  
moulded compartments.

Size: 9-3/4" w. x 13-3/4" l. x 2" d.

## SQUARE DRIVE MACHINE SCREW and NUT MASTER ASSORTMENT No. 020-624

- Contains 1120 pieces - 32 sizes, Round and Flat Head and Hexagon Nuts.
- Metal box with moulded plastic compartments.
- Safety snap carrying handle.
- Actual size illustrations and retail price codes of every item shown on grease-resistant lid label.
- Refills available in standard packages of 100.

A practical assortment that gives complete coverage of all popular sizes of Machine Screws and Nuts.

## **papeo** SUPER SERVICE ASSORTMENT No. 020-806

### MACHINE SCREW and NUT SUPER-SERVICE ASSORTMENT No. 020-806

- Contains 2750 pieces - 32 sizes, Round and Flat Head Square Drive Machine Screws with Nuts.
- Large size, rigid metal box with high-strength plastic compartments.
- Convenient, safety snap carrying handle.
- Actual size illustrations and retail codes of every item shown on grease-resistant lid label.
- Refills available in standard packages of 100.

Perfect for Dealers, Jobbers and large users. This popular assortment has a wide range of carefully selected Machine Screws and Nuts in balanced quantities.



Size: 12" w. x 18" l. x 3" d.

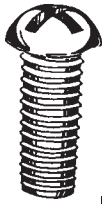

# papco<sup>®</sup> PHILLIPS MACHINE SCREWS VIS DE MECANIQUE PHILLIPS



## BRIGHT PLATED

Phillips Type (cross recessed) screws are used on all trim applications.

**173**  
Round  
Head

**175**  
Oval  
Head

Order by Stock Number

Standard Package 100 pieces

Papco Stock Nos.		Screw Diameter	Threads Per Inch	Screw Length	Decimal Equivalent
Round	Oval				
173-085		6	32	3/8"	.138"
173-135		8	32	3/8"	
173-137	175-137			1/2"	.164"
173-139	175-139			3/4"	
173-141	175-141			1"	
173-189		10	24	1/2"	
173-191	175-191			3/4"	.190"
173-193				1"	
173-215		10	32	3/8"	
173-217	175-217			1/2"	.190"
173-219				3/4"	
173-305		1/4	20	1/2"	
173-307	175-307			3/4"	.250"
173-309				1"	

## papco<sup>®</sup> PHILLIPS MACHINE SCREW ASSORTMENTS



### MASTER ASSORTMENT No. 020-623

- Contains 786 pieces – 20 sizes. Round and Oval Head and Hexagon Nuts.
- Rigid, metal box with handy moulded compartments.
- Carrying handle with safety snap lock.
- Illustrated lid label shows retail codes.
- Refills available in standard packages.

### GARAGE ASSORTMENT No. 020-012 Round Head

Assortment contains 100 Plated Phillips Head Machine Screws and 50 Hexagon Plated Nuts in popular sizes.

Packed in a rigid, transparent plastic container.

Order by Stock Number.



**197**  
Flat  
Steel

**203**  
Flat  
Brass



# Papco® WOOD SCREWS VIS A BOIS

'LOXXON' SQUARE SOCKET DRIVE

"Papco" Wood Screws are available in over 300 stock sizes in Brass and Steel and in various Head Styles and Drives. All 'Papco' Steel Wood Screws listed here are Bright Plated.



**198**  
Round  
Steel

**204**  
Round  
Brass

Flat Socket Steel add prefix 197  
Flat Socket Brass add prefix 203



Round Socket Steel add prefix 198  
Round Socket Brass add prefix 204

Example of Stock No. 197-139 is 8 x 3/4 Flat Socket Steel Wood Screws Plated.

Example of Stock No. 203-139 is 8 x 3/4 Flat Socket Brass Wood Screws.

Order by Stock Number

Standard Package 100 Screws

Diameter	No. 4	No. 5	No. 6	No. 7	No. 8	No. 9	No. 10	No. 12	No. 14
Decimal Equiv. of Diameter	.112	.125	.138	.155	.165	.177	.191	.218	.251
Drill Pilot Hole*	3/64	1/16	1/16	1/16	5/64	5/64	3/32	7/64	7/64
Drill Shank Hole*	7/64	1/8	9/64	5/32	11/64	3/16	3/16	7/32	1/4
Length									
1/2	-043	-063	-087	-111	-137				STEEL SOCKET ONLY
5/8	-044	-064	-088	-112	-138				
3/4	-045	-065	-089	-113	-139		-191		
1	-047	-067	-091	-115	-141	-167	-193	-250	-280
1-1/4			-093	-117	-143	-169	-195	-252	-282
1-1/2			-095	-119	-145	-171	-197	-254	-284
1-3/4							-199		-286
2					-148		-200	-257	-287
2-1/2					-150		-202	-259	-289
3							-204	-261	-291

\* Sizes of holes recommended for average application. Slightly larger or smaller holes may be required for hard or soft woods.

Note: Additional sizes of Wood Screws in Steel, Brass, Stainless Steel and Silicon Bronze are available - see current Non-Ferrous catalogue.

## Papco® WOOD SCREWS ASSORTMENTS ASSORTIMENTS DE VIS A BOIS

### GARAGE ASSORTMENT

No. 020-201

STEEL

Contains 160 pieces - 8 sizes of Flat Socket Head Steel Wood Screws Plated. Packed in a transparent plastic box.



### GARAGE ASSORTMENT

No. 020-210

BRASS

Contains 155 pieces - 8 sizes of mostly Flat and Round Socket Head Brass Wood Screws from 6 x 1/2 to 8 x 1-1/2. Packed in a transparent plastic box.



### UTILITY ASSORTMENT

No. 020-354

STEEL

Contains 460 pieces Flat and Round Socket Steel Wood Screws Plated. Twelve sizes from No. 4 x 1/2 to No. 10 x 1-1/2. Strong display box with moulded plastic compartments. Refills available in standard packages.



### UTILITY ASSORTMENT

No. 020-356

BRASS

Contains 380 pieces Flat and Round Socket Brass Wood Screws. Twelve sizes from No. 4 x 1/2 to No. 10 x 1-1/2. Packed in a sturdy fibre - board container.

### MASTER ASSORTMENT

No. 020-600

STEEL

Contains 850 pieces Flat and Round Socket Steel Wood Screws Plated. Twelve sizes from No. 4 x 1/2 to No. 10 x 1-1/2. Packed in a metal box with moulded plastic compartments.

### MASTER ASSORTMENT

No. 020-601

BRASS

Contains 735 pieces Flat and Round Socket Brass Wood Screws. Twelve sizes from No. 4 x 1/2 to No. 10 x 1-1/2. Packed in a metal box with moulded plastic compartments.



# PAPCO® TAPPING SCREWS VIS TARAUEUSES



SHEET METAL SCREWS    SLOT HEAD    BRIGHT PLATED

**205**  
Pan  
Head

SELF-TAPPING



HARDENED

**206**  
Oval  
Head

"Papco" Sheet Metal Screws are used in the assembly of sheet metal parts and for making fastenings to sheet metal. They are used in body work for attaching window moulding, trim, panels, metal drip moulding and many other applications.

Order by Stock Number

Standard Package 100 pieces.

Pan Head Stock No.	Oval Head Stock No.	Screw Dia.	Screw Length	Decimal Eq. of Dia.	Drill Hole	Pan Head Stock No.	Oval Head Stock No.	Screw Dia.	Screw Length	Decimal Eq. of Dia.	Drill Hole
205-039			1/4			205-187			3/8		
205-041		4	3/8	.112"	5/64"	205-189	206-189		1/2		
205-043	206-043		1/2			5/8					
205-044	206-044		5/8			3/4	.191"	9/64"			
205-083						1					
205-085	206-085	6	3/8	.138"	3/32"	205-193	206-193		1		
205-087	206-087		1/2			1-1/4					
205-088	206-088		5/8			1-1/2					
205-089	206-089		3/4			5/8					
205-091	206-091		1			3/4	.218"	5/32"			
205-093	206-093		1-1/4			1					
205-135						1-1/4					
205-137	206-137					3/8					
205-138	206-138	8	1/2	.165"	1/8"	205-247			5/8		
205-139	206-139		3/4			3/4					
205-141	206-141		1			1-1/2					
205-143	206-143		1-1/4			1	.251"	3/16"			
205-145			1-1/2			1-1/4					
						3/8					
						1/2					
						5/8					
			3/4								
			1								
			1-1/4								
			1-1/2								
			3/8								
			1/2								
			5/8								
			3/4								
			1								
			1-1/4								
			1-1/2								
			3/8								
			1/2								
			5/8								
			3/4								
			1								
			1-1/4								
			1-1/2								
			3/8								
			1/2								
			5/8								
			3/4								
			1								
			1-1/4								
			1-1/2								
			3/8								
			1/2								
			5/8								
			3/4								
			1								
			1-1/4								
			1-1/2								
			3/8								
			1/2								
			5/8								
			3/4								
			1								
			1-1/4								
			1-1/2								
			3/8								
			1/2								
			5/8								
			3/4								
			1								
			1-1/4								
			1-1/2								
			3/8								
			1/2								
			5/8								
			3/4								
			1								
			1-1/4								
			1-1/2								
			3/8								
			1/2								
			5/8								
			3/4								
			1								
			1-1/4								
			1-1/2								
			3/8								
			1/2								
			5/8								
			3/4								
			1								
			1-1/4								
			1-1/2								
			3/8								
			1/2								
			5/8								
			3/4								
			1								
			1-1/4								
			1-1/2								
			3/8								
			1/2								
			5/8								
			3/4								
			1								
			1-1/4								
			1-1/2								
			3/8								
			1/2								
			5/8								
			3/4								
			1								
			1-1/4								
			1-1/2								
			3/8								
			1/2								
			5/8								
			3/4								
			1								
			1-1/4								
			1-1/2								
			3/8								
			1/2								
			5/8								
			3/4								
			1								
			1-1/4								
			1-1/2								
			3/8								
			1/2								
			5/8								
			3/4								
			1								
			1-1/4								
			1-1/2								
			3/8								
			1/2								
			5/8								
			3/4								
			1								
			1-1/4								
			1-1/2								
			3/8								
			1/2								
			5/8								
			3/4								
			1								
			1-1/4								
			1-1/2								
			3/8								
			1/2								
			5/8								
			3/4								
			1								
			1-1/4								
			1-1/2								
			3/8								
			1/2								
			5/8								
			3/4								
			1								
			1-1/4								
			1-1/2								
			3/8								
			1/2								
			5/8								
			3/4								
			1								
			1-1/4								
			1-1/2								
			3/8								
			1/2								
			5/8								
			3/4								
			1								
			1-1/4								
			1-1/2								
			3/8								
			1/2								
			5/8								
			3/4								
			1								
			1-1/4								
			1-1/2								
			3/8								
			1/2								
			5/8								
			3/4								
			1								
			1-1/4								
			1-1/2								
			3/8								
			1/2								
			5/8								
			3/4								
			1								
			1-1/4								
			1-1/2								
			3/8								
			1/2								
			5/8								
			3/4								
			1								
			1-1/4								
			1-1/2								
			3/8								
			1/2								
			5/8								
			3/4								
			1								
			1-1/4								
			1-1/2								
			3/8								
			1/2								
			5/8								
			3/4								
			1								
			1-1/4								
			1-1/2								
			3/8								
			1/2								
			5/8								
			3/4								
			1								
			1-1/4								
			1-1/2								
			3/8								
			1/2								
			5/8								
			3/4								
			1								
			1-1/4								
			1-1/2								
			3/8								
			1/2								
			5/8								
			3/4								
			1								
			1-1/4								
			1-1/2								
			3/8								
			1/2								
			5/8								
			3/4								
			1								
			1-1/4								
			1-1/2								
			3/8								
			1/2								
			5/8								
			3/4								
			1								
			1-1/4								
			1-1/2								
			3/8								
			1/2								
			5/8								
			3/4								
			1								
			1-1/4								
			1-1/2								
			3/8								
			1/2								
			5/8								
			3/4								
			1								
			1-1/4								
			1-1/2								
			3/8								
			1/2								
			5/8								
			3/4								
			1								



# **papco**® TAPPING SCREW ASSORTMENTS ASSORTIMENTS VIS TARAUDEUSES

## **GARAGE ASSORTMENT No. 020-024 HEXAGON HEAD**

Contains 100 Hexagon Head Tapping Screws in various lengths and diameters from 8 x 1/2 to 5/16 x 1.



## **GARAGE ASSORTMENT No. 020-026 PAN SLOT**

Contains 165 Pan Slot Head Tapping Screws in various lengths and diameters from 4 x 1/2 to 14 x 1.

## **GARAGE ASSORTMENT No. 020-200 PAN SOCKET**

Contains 175 Pan Socket Head Tapping Screws in various lengths and diameters from 6 x 1/2 to 10 x 1.

## **TAPPING SCREW UTILITY ASSORTMENT No. 020-312**

### **SLOT**

Contains 495 pieces – 18 sizes, Pan and Oval Slot Heads. Packed in a sturdy fibreboard container with plastic tray. Actual size illustrations and retail price codes of every item shown on lid label.



No. 020-312  
Size: 7-1/2" x 12" x 1-1/4"

## **TAPPING SCREW UTILITY ASSORTMENT No. 020-353**

### **SOCKET**

Contains 500 pieces – 16 sizes, Pan Socket Head. Packed in a sturdy fibreboard container with moulded plastic trays. Refills available in standard packages.

Here are two assortments of "Papco: Sheet Metal Screws designed especially for Dealers, Service Stations and Garages. Use these attractive, permanent merchandisers to increase your sales – and profits – on this fast moving line!

## **TAPPING SCREW MASTER ASSORTMENT No. 020-612**

### **SLOT**

Contains 937 pieces – 18 sizes of Pan, Oval and Hex Slot Tapping Screws. Metal box with moulded plastic compartments and hinged lid. Actual size illustrations and retail price codes on lid label. Refills available in standard packages.



Metal Merchandiser with moulded compartments  
Size: 9-3/4" w. x 13-3/4" l. x 2" d.

No. 020-612

## **TAPPING SCREW MASTER ASSORTMENT No. 020-660**

### **SOCKET**

Contains 1000 pieces — 25 sizes of Pan Socket Head Tapping Screws. Packed in a metal box with high-strength plastic compartments. Actual size illustrations and retail price codes of every item shown on grease-resistant lid label.



## **TAPPING SCREW MASTER ASSORTMENT No. 020-615**

Excellent assortment of Hexagon Steel Metal Screws and Fender Washers for the well-equipped Body Shop

- Contains 280 Hexagon Head Screws  
125 Flat Fender Washers  
20 Popular Sizes

Size: 9-3/4" w. x 13-3/4" l. x 2" d.

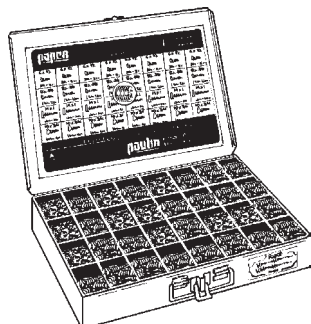

## **papco**® SUPER SERVICE ASSORTMENT No. 020-807

Contains 1450 Pan and Oval Slot Head Tapping Screws — 32 items. Large size, rigid metal box with high-strength plastic compartments.

For more details see page 9.

Large size: 12" w. x 18" l. x 3" d.



# SOCKET TAPPING SCREWS VIS TARAUEUSES CREUSE

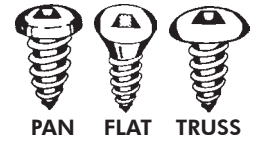

<b>208</b> Pan Head	<b>209</b> Flat Head	<b>210</b> Truss Head
---------------------------	----------------------------	-----------------------------

'LOXXON'® SQUARE SOCKET DRIVE



SHEET METAL SCREWS

SELF-TAPPING

BRIGHT PLATED

HARDENED

Specify "Papco" Pan, Flat or Truss Socket Head Tapping Screws where a positive driver engagement, or where high-speed assembly of sheet metal parts, is required. They are used in body work, mouldings, trim, sheet metal work and many other applications.

Order by Stock Number

Standard Package 100 pieces.

Pan Head Stock No.	Flat Head Stock No.	Truss Hd. Stock No.	Screw Dia.	Screw Length	Decimal Eq. of Dia.	Drill Hole	Pan Head Stock No.	Flat Head Stock No.	Truss Hd. Stock No.	Screw Dia.	Screw Length	Decimal Eq. of Dia.	Drill Hole
208-039				1/4			208-187				3/8		
208-041	209-041		4	3/8			208-189	209-189	210-189		1/2		
208-043	209-043			1/2	.112"	5/64"	208-190	209-190	210-190		5/8		
208-045	209-045			3/4			208-191	209-191	210-191	10	3/4	.191"	9/64"
208-047	209-047			1			208-193	209-193	210-193		1		
208-083				1/4			208-195	209-195	210-195		1-1/4		
208-085	209-085	210-085		3/8			208-197	209-197			1-1/2		
208-087	209-087	210-087	6	1/2	.138"	3/32"	208-200	209-200			2		
208-088	209-088	210-088		5/8			208-246	209-246			1/2		
208-089	209-089	210-089		3/4			208-248	209-248			3/4		
208-091	209-091	210-091		1			208-250	209-250		12	1	.218"	5/32"
208-093	209-093			1-1/4			208-252	209-252			1-1/4		
208-095	209-095			1-1/2			208-254	209-254			1-1/2		
208-135		210-135		3/8			208-257				2		
208-137	209-137	210-137		1/2			208-277	209-277			5/8		
208-138	209-138	210-138		5/8			208-278	209-278			3/4		
208-139	209-139	210-139	8	3/4	.165"	1/8"	208-280	209-280		14	1	.251"	3/16"
208-141	209-141	210-141		1			208-282	209-282			1-1/4		
208-143	209-143	210-143		1-1/4			208-284	209-284			1-1/2		
208-145	209-145	210-145		1-1/2			208-287	209-287			2		
208-148	209-148			2									

<b>213</b> Hex Head
---------------------------



# HEX HEAD TAPPING SCREWS VIS TARAUEUSES TETE HEX



PLATED

SELF-TAPPING

HARDENED

Oversize Hexagon Washer Heads to fit Automotive Cap Screw Wrenches.

Order by Stock Number

Standard Package 100 pieces.

'Papco' Stock No.	Screw Dia.	Screw Length	Decimal Eq. of Dia.	Across Flats	Drill Hole	'Papco' Stock No.	Screw Dia.	Screw Length	Decimal Eq. of Dia.	Across Flats	Drill Hole
213-085	6	3/8	.138"	1/4"	3/32"	213-250	12	1	.218"	5/16"	5/32"
213-137		1/2				213-276		1/2			
213-139		3/4				213-277		5/8			
213-141	8	1	.165"	1/4"	1/8"	213-278	14	3/4	.251"	7/16"	3/16"
213-143		1-1/4				213-280		1			
213-145		1-1/2				213-282		1-1/4			
213-187		3/8				213-284		1-1/2			
213-189		1/2				213-442		3/4			
213-190	10	5/8	.191"	5/16"	9/64"	213-444	5/16	1	.312"	1/2"	9/32"
213-191		3/4				213-446		1-1/4			
213-193		1				213-448		1-1/2			
213-246	12	1/2	.218"	5/16"	5/32"	213-489	3/8	1	.375"	9/16"	11/32"
213-248		3/4				213-493		1-1/2			

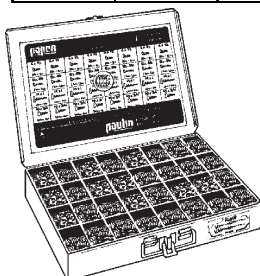

## SUPER SERVICE ASSORTMENT No. 020-808

Contains 650 Hexagon Head Tapping Screws and Fender Washers.  
Large size, rigid metal box with high-strength plastic compartments.

For more details see page 9.

Large size: 12" w. x 18" l. x 3" d.

**140**  
Carded

# papeco® POWER DRIVER BITS POINTES DE TOURNEVIS

• 2 PIECE CONSTRUCTION • 'LOXXON'® SQUARE DRIVE

**8140**  
Packaged

'Papco' 'Loxxon' Square Drive Bits are precision crafted from impact resistant tool steel and offer the best combination of hardness and toughness for maximum durability. Available in 1, 2, 3, 4 and 6 inch lengths.

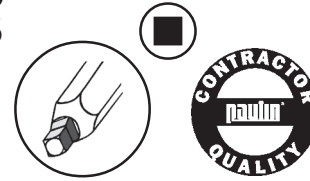

**S2 STEEL**

Order by Stock Number

Individually Carded\* or Packaged

Bit Size	1" Long			2" Long			3" Long	4" Long	6" Long	Fits Screw Dia.
	Carded Stock No.	Packaged Stock No.	Std. Pkg.	Carded Stock No.	Packaged Stock No.	Std. Pkg.	Carded Stock No.	Carded Stock No.	Carded Stock No.	
No. 0	140-310*	—	—	—	—	—	—	—	—	No.3 & 4
No. 1	140-311*	8140-311	10	140-321	8140-321	10	140-331	140-341	140-361	No.5 to 7
No. 2	140-312*	8140-312	25	140-322	8140-322	10	140-332	140-342	140-362	No.8 to 10
No. 3	140-313*	8140-313	10	140-323	8140-323	10	140-333	140-343	140-363	No.12 & 14

\* Indicates 2 bits per card

Available in Bulk - price on application.

**140**  
Carded

# papeco® POWER DRIVER BITS POINTES DE TOURNEVIS

**PHILLIPS DRIVE**

**8140**  
Packaged

'Papco' Phillips Drive bits are made of the same impact resistant hardened tool steel as the Loxxon Square Drive Bits for maximum performance.

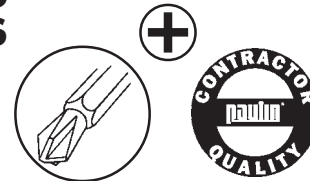

Order by Stock Number

Individually Carded\* or Packaged

Bit Size	1" Long			2" Long			3" Long	4" Long	Fits Screw Dia.
	Carded Stock No.	Packaged Stock No.	Std. Pkg.	Carded Stock No.	Packaged Stock No.	Std. Pkg.	Carded Stock No.	Carded Stock No.	
No. 1	140-411*	8140-411	10	140-421	8140-421	10	—	—	No.2 to 4
No. 2	140-412*	8140-412	25	140-424	8140-424	10	—	—	No.5 to 10
No. 3	140-413*	8140-413	10	140-423	8140-423	10	—	—	No.12 to 16
Drywall	140-422*	8140-422	25	—	—	—	—	—	All Drywall Scr.

\* Indicates 2 bits per card

Available in Bulk - price on application.

**8020**  
Series

# papeco® ASSORTED BIT KITS JEUX DES POINTE ASSORTIS



Choose from 4 skin-packed Assorted Bit Kits each containing No. 1, 2 and 3 bit sizes in either 'Loxxon' Square Drive or Phillips in either 1" or 2" bit lengths.



**1" 'LOXXON' SQUARE DRIVE ASSORTED BITS KIT No. 8020-900**



**2" 'LOXXON' SQUARE DRIVE ASSORTED BITS KIT No. 8020-901**



**1" PHILLIPS DRIVE ASSORTED BITS KIT No. 8020-902**



**2" PHILLIPS DRIVE ASSORTED BITS KIT No. 8020-903**

## 7 Pc. BIT ASSORTMENT No. 8020-907

Contains six 1" long 'Loxxon' Square Drive and Phillips Drive bits in No. 1, 2 and 3 bit sizes - plus a 1/4 x 3" magnetic Bit Holder in a clear plastic pack.

## 14 Pc. BIT ASSORTMENT No. 8020-915

Contains six 1" and 2" long 'Loxxon' Square Drive bits - six 1" and 2" long Phillips Drive bits in No. 1, 2 and 3 bit sizes - plus two 6-Lobe bits in a see-through plastic pack.

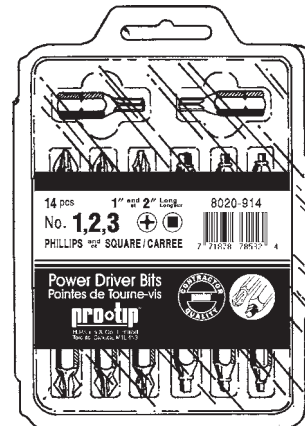

8020-915

**222**  
Series

**papeco** BIT ACCESSORIES  
ACCESSOIRE DE POINTES

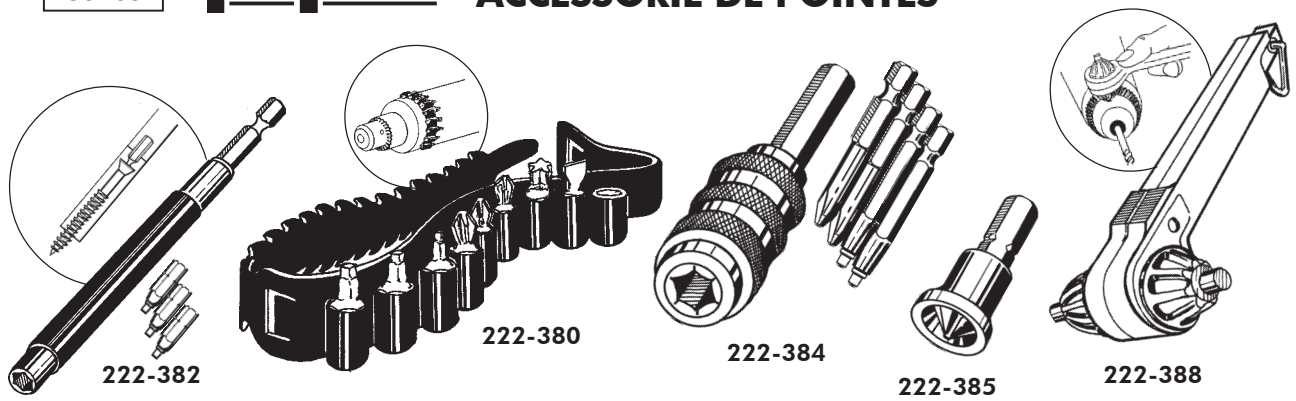

Order by Stock Number

Individually Skin-packed

Stock No.	Description
222-380	Power Bit Belt - straps to most power drills - Includes 9 assorted bits including 6-Lobe
222-382	Screw Starter Driver - sliding guide sleeve over magnetic chuck - includes 3 square drive bits
222-384	Quick Change Chuck - includes four 2" long assorted 'Loxon' and Phillips bits (No. 1 and 2 Points)
222-385	Drywall Screw Dimpler - includes Drywall Screw Bit
222-388	Ratchet Key - chuck key for most power drills and bench tools - fast bit change-overs

**papeco** CARDED  
BIT MERCHANDISER  
No. 022-154

Contains 11 sizes of 1, 2 and 3 inch long carded bits in No. 1 to 3 'Loxon' Square and Phillips Drives - plus two sizes of 6-Lobe Drive Bits. Also includes Assorted Bit Kits No. 8020-900, 901, 902 and 903 of 1 and 2 inch long Square and Phillips Bits. Magnetic Bit Holder 222-355, 6 in 1 Magnetic Screwdriver 222-995 and Magnetic 6-Lobe Screwdriver 231-975 for a grand total of 20 items - 54 cards on an attractive, point-of-purchase display rack that can be hung on a wall or displayed on a counter.

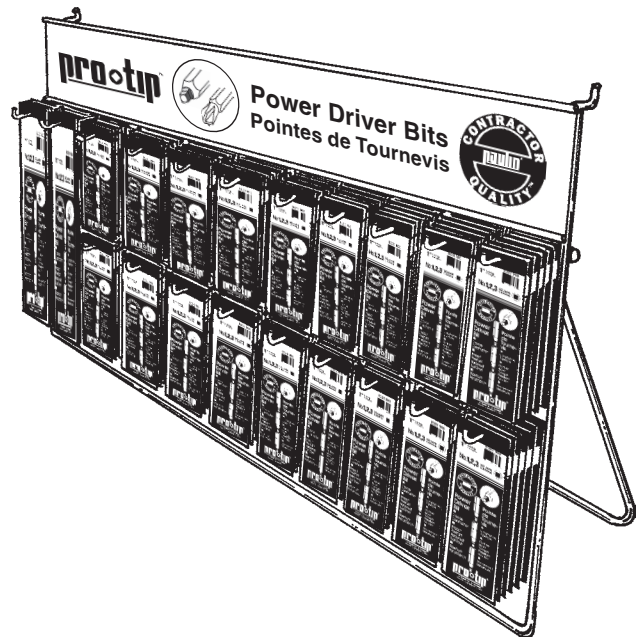

**papeco** 7 Pc. POCKET KIT  
SCREWDRIVERS

Injection molded plastic hinged kit features No. 1 and No. 2 'Loxon' Square Drive Bits and Phillips Bits, 8-10 Slot Bit, T-15 6-Lobe Bit and a 2" Magnetic Bit Holder. Handy belt clip attached.

Order by Stock Number Individually Carded

Stock No.	Colour	Stock No.	Colour
020-923	Green	020-926	Red
020-924	Yellow	020-927	Black
020-925	Orange		

POCKET KIT COUNTER DISPLAY No. 020-928  
Contains 24 Pocket Screwdriver Kits No. 020-927 in an attractive counter display box.

