

3.4

Control Relays and Timers

General Purpose Plug-In Relays

3

General Purpose Plug-In Relays, continued

Relay Series

D8

D9



Approvals



Features

Dust cover	Dust cover
Panel, DIN and flange mounting	Pushbutton available
Quick-connect and screw terminals	Panel mounting
	Screw terminals

Contact Data

Configuration	4PST			
	SPST-NO	DPST-NO	NO	NC
Max. allowable load	30 A at 220 Vac	25 A at 220 Vac	25 A at 220 Vac	8 A at 220 Vac
Material	AgCdO		AgCdO	
Dielectric strength	4000 V		4000 V	

Coil Data

AC	6 to 240 Vac	24 to 240 Vac
DC	12 to 24 Vdc	12 to 110 Vdc
Power		
VA (Vac)	2.5 VA	2.6 VA
Watts (Vdc)	1.9 W	2.0 W

General Data

Ambient temperature		
Storage	-4 °F to +185 °F (-20 °C to +85 °C)	-13 °F to +140 °F (-25 °C to +60 °C)
Operational	-4 °F to +131 °F (-20 °C to +55 °C)	-13 °F to +140 °F (-25 °C to +60 °C)
Response time	30 milliseconds	50 milliseconds
Life		
Mechanical operations	5 million	1 million
Electrical operations	100,000	100,000
Page Numbers	V7-T3-103 to V7-T3-107	V7-T3-108 to V7-T3-111

D1 Series Relay



D1RR/D1RF Series

Product Description

The D1 Series of relay provides a compact single-pole relay capable of handling 15 A. Multiple feature and voltage options allow for the perfect fit for any application.

Features

D1RR

- Compact relay capable of breaking relatively large load currents
- Panel and DIN rail mounting

D1RF

- The contact operation can be easily checked by Push-to-Test button
- Flag indicator shows relay status in manual or powered condition
- LED status lamp shows coil ON or OFF status—ideal for use in low light applications
- Push-to-Test button allows for manual operation of relay without the need for coil power
- Lock-down door holds pushbutton and contacts in the operate position when activated
- Finger-grip cover allows operator to remove relays from sockets easily
- ID tag/write label to identify relays in multiple-relay circuits
- Bipolar LED allows for reverse polarity applications

Contents

Description

	<i>Page</i>
D1RR/D1RF Series	
Product Selection	V7-T3-54
Accessories	V7-T3-54
Technical Data and Specifications	V7-T3-55
Wiring Diagram	V7-T3-56
Dimensions	V7-T3-56
D2RR/D2RF Series	V7-T3-57
D3RR/D3RF Series	V7-T3-67
D4 Series	V7-T3-76
D5RR/D5RF Series	V7-T3-80
D7PR/D7PF Series	V7-T3-89
D8 Series	V7-T3-103
D9 Series	V7-T3-108
Accessories	V7-T3-112

Standards and Certifications



 When used with accompanying Eaton screw terminal socket.

Catalog Number Selection

D1RF/D1RR Series

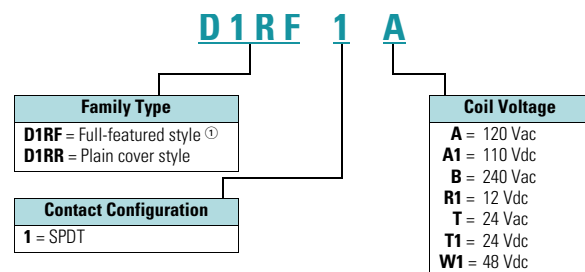

Note

① Full-featured, LED test button, flag indicator, lock-down door, finger-grip cover, ID tag.

3.4

Control Relays and Timers

General Purpose Plug-In Relays

3

Product Selection

D1RR/D1RF Relay/Socket Quick Reference

Relay Type	Socket	Clip	Module Type	ID Tag	Jumper
D1RR1	D1PAA	PMC-1781	B	—	—
D1RF1	D1PAA	PMC-1781	B	—	—

D1RF Series Relay



D1RR/D1RF Series

Coil Voltage	Contact Configuration	Coil Resistance (Ohms)	Catalog Number
Full Featured			
12 Vdc	SPDT	188	D1RF1R1
24 Vac 50/60 Hz	SPDT	180	D1RF1T
24 Vdc	SPDT	750	D1RF1T1
110 Vdc	SPDT	13,800	D1RF1A1
120 Vac 50/60 Hz	SPDT	4430	D1RF1A
240 Vac 50/60 Hz	SPDT	15,720	D1RF1B
Plain Cover			
12 Vdc	SPDT	188	D1RR1R1
24 Vdc	SPDT	750	D1RR1T1
48 Vdc	SPDT	2600	D1RR1W1
110 Vdc	SPDT	13,800	D1RR1A1
120 Vac 50/60 Hz	SPDT	4430	D1RR1A
240 Vac	SPDT	15,270	D1RR1B

Accessories

D1RR/D1RF Sockets and Accessories

Type	Module Size	Nominal Voltage (Max. for Sockets)	Nominal Current	Mounting Style	Wire Size	Wire Connection	Standard Pack	Catalog Number
Socket	B	300	20	Panel/DIN rail	12 /14 (2) AWG, 4 /2.5 (2) mm ²	Screw clamping	10	D1RAA ①
Flange mount adapter	—	—	—	Flange	—	—	25	PFC-D11
Metal spring clip	—	—	—	—	—	—	25	PMC-1781
Protection diode	B	6 to 250 Vdc	—	—	—	—	20	MOD-BD250
LED indicator	B	24 Vac/Vdc	—	—	—	—	20	MOD-BLG24
	B	120/240 Vac/Vdc	—	—	—	—	20	MOD-BLG240
MOV suppressor	B	120 Vac/Vdc	—	—	—	—	20	MOD-BMV120
	B	24 Vac/Vdc	—	—	—	—	20	MOD-BMV24
	B	240 Vac/Vdc	—	—	—	—	20	MOD-BMV240
Plastic DIN rail end stop	—	—	—	—	—	—	25	PPF-P

Note

① Protection Category (Finger Safe), EN 60529: IP20.

Technical Data and Specifications**D1RF/D1RR Relay Specifications**

Description	D1RR	D1RF
Contact Characteristics		
Contact rating	15 A	15 A
Terminal style	Plug-in	Plug-in
Contact materials	Silver alloy	Silver alloy
Maximum switching voltage	300 V	300 V
Switching current at voltage—resistive	20 A at 120 Vac 50/60 Hz	20 A at 120 Vac 50/60 Hz
	20 A at 277 Vac 50/60 Hz	20 A at 277 Vac 50/60 Hz
	20 A at 28 Vdc	20 A at 28 Vdc
Switching current at voltage	1/2 hp at 120 Vac	1/2 hp at 120 Vac
	1 hp at 277 Vac	1 hp at 277 Vac
Pilot duty	B300	B300
Minimum switching requirement	100 mA at 5 Vdc (0.5 W)	100 mA at 5 Vdc (0.5 W)
Coil Characteristics		
Operating range		
% of nominal (AC)	85 to 110%	85 to 110%
% of nominal (DC)	80 to 110%	80 to 110%
Average consumption	0.9 VA	0.9 VA
	0.7 W	0.7 W
Dropout voltage threshold	15% (AC)	15% (AC)
	10% (DC)	10% (DC)
Performance		
Electrical life (UL 508) operations at rated current	100,000 operations	100,000 operations
Mechanical life operations unpowered	10,000,000 operations	10,000,000 operations
Response time	20 ms	20 ms
Dielectric strength		
Between coil and contact Vac (rms)	2500 V (rms)	2500 V (rms)
Between poles Vac (rms)	1500 V (rms)	1500 V (rms)
Environment		
Ambient air temperature around the device		
Storage	−40 °F to +131 °F (−40 °C to +55°C)	−40 °F to +131 °F (−40 °C to +55 °C)
Operation	−40 °F to +185 °F (−40 °C to +85°C)	−40 °F to +185 °F (−40 °C to +85 °C)
Vibration resistance—operational	3 g-n at 10–55 Hz	3 g-n at 10–55 Hz
Shock resistance	10 g-n	10 g-n
Degree of protection	IP40	IP40
Features		
Cover options	Plain cover	Full featured
Features	Mechanical flag indicator (optional LED)	Locking pushbutton/ Bipolar LED/ Removable ID tag/ Mechanical flag indicator
Product certifications	RoHS/UL/CE/CSA	RoHS/UL/CE/CSA

3.4

Control Relays and Timers

General Purpose Plug-In Relays

Wiring Diagram

D1RF/D1RR

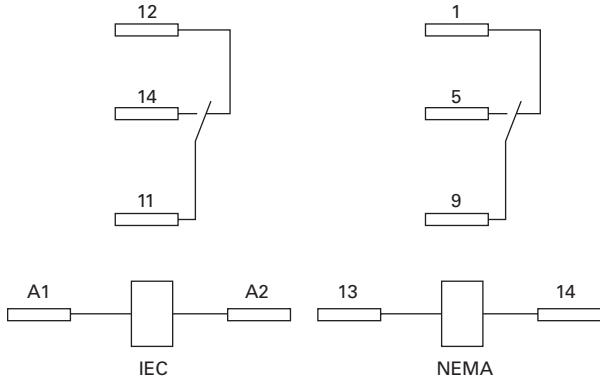

Dimensions

Approximate Dimensions in Inches (mm)

D1RF/D1RR

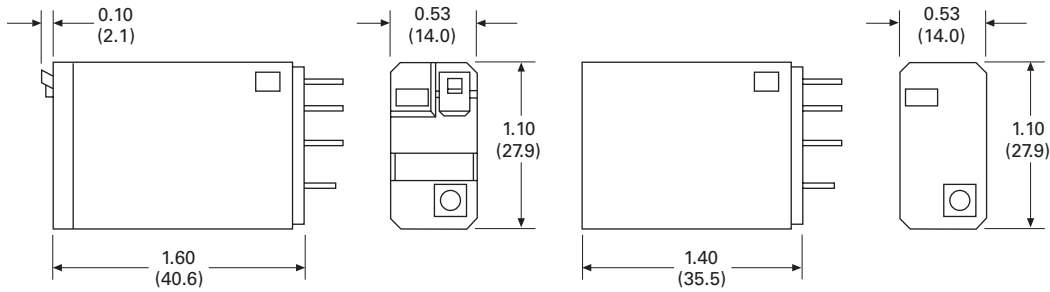

D1RAA

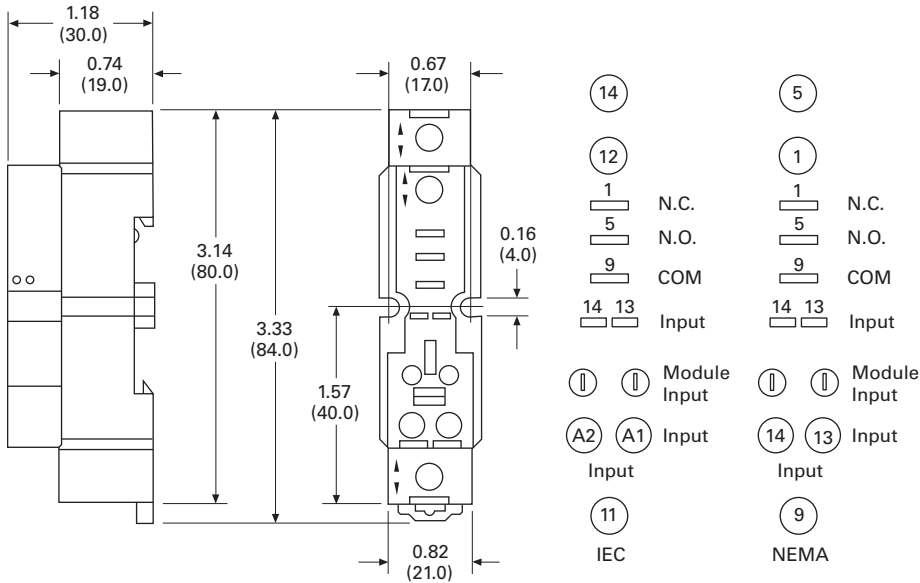

D2 Series Relay



D2RR/D2RF Series

Product Description

The D2 Series is a compact line of relays with quick response time and long life. Available in DPDT and 4PDT configurations.

Features

D2RR

- Ultra-high sensitivity relay with quick response
- High reliability, long life
- Panel, DIN rail and flange mounting
- Small size

Contents

Description

	Page
D1RR/D1RF Series	V7-T3-53
D2RR/D2RF Series	
Catalog Number Selection	V7-T3-58
Product Selection	V7-T3-58
Accessories	V7-T3-60
Technical Data and Specifications	V7-T3-61
Wiring Diagrams	V7-T3-62
Dimensions	V7-T3-63
D3RR/D3RF Series	V7-T3-67
D4 Series	V7-T3-76
D5RR/D5RF Series	V7-T3-80
D7PR/D7PF Series	V7-T3-89
D8 Series	V7-T3-103
D9 Series	V7-T3-108
Accessories	V7-T3-112

Standards and Certifications



 When used with accompanying Eaton screw terminal socket.

D2RF

- Flag indicator shows relay status in manual or powered condition
- Bipolar LED status lamp allows for reverse polarity applications
 - Shows coil ON or OFF status
 - Ideal in low light conditions
- Color-coded pushbutton identifies AC coils with red or DC coils with blue pushbuttons
 - Allows for manual operation of relay without the need for coil power
 - Ideal for field service personnel to test control circuits
- Lock-down door, when activated, holds pushbutton and contacts in the operate position
 - Excellent for analyzing circuit problems
- Finger-grip cover allows operator to remove relays from sockets more easily than conventional relays
- White plastic ID tag/write label used for identification of relays in multi-relay circuits

3.4

Control Relays and Timers

General Purpose Plug-In Relays

Catalog Number Selection

D2RF/D2RR ①

3

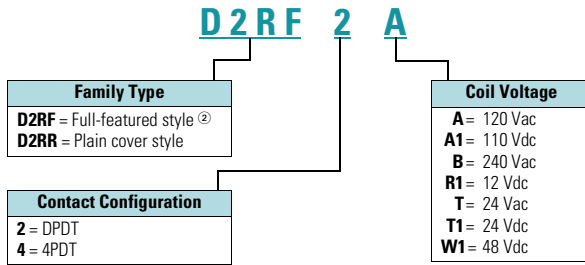

Product Selection

D2RF/D2RR Relay/Socket Quick Reference

Relay Type	Socket	Clip	Module Type	ID Tag	Jumper
D2RR2, D2RF2	D2PAL	PWC-D24	B	PWF-D2P	D2PJ1
		PQC-1782	—	—	—
	D2PA6	PQC-1342	None	—	—
D2RR4, D2RF4	D2PAP	PWC-D24	B	PWF-D2P	D2PJ1
		PQC-1782	—	—	—
	D2PA7	PWC-D24	B	—	—
		PQC-1782	B	—	—
	D2PA6	PQC-1342	None	—	—

Notes

- ① For deciphering catalog numbers. Do not use for ordering as not all combinations are readily available.
- ② Full-featured, LED test button, flag indicator, lock-down door, finger-grip cover, ID tag.

D2RF Series Relay



D2RF/D2RR Series

Coil Voltage	Contact Configuration	Coil Resistance (Ohms)	Catalog Number
Full Featured Style			
12 Vdc	DPDT	160	D2RF2R1
24 Vac	DPDT	180	D2RF2T
24 Vdc	DPDT	650	D2RF2T1
48 Vdc	DPDT	2600	D2RF2W1
110/125 Vdc	DPDT	11,000	D2RF2A1
120 Vac	DPDT	4430	D2RF2A
220/240 Vac	DPDT	15,720	D2RF2B
12 Vdc	4PDT	160	D2RF4R1
24 Vac	4PDT	180	D2RF4T
24 Vdc	4PDT	650	D2RF4T1
48 Vdc	4PDT	2600	D2RF4W1
110/125 Vdc	4PDT	11,000	D2RF4A1
120 Vac	4PDT	4430	D2RF4A
220/240 Vac	4PDT	15,720	D2RF4B
Plain Cover Style			
12 Vdc	DPDT	160	D2RR2R1
24 Vac	DPDT	180	D2RR2T
24 Vdc	DPDT	650	D2RR2T1
120 Vac	DPDT	4430	D2RR2A
220/240 Vac	DPDT	15,720	D2RR2B
12 Vdc	4PDT	160	D2RR4R1
24 Vac	4PDT	180	D2RR4T
24 Vdc	4PDT	650	D2RR4T1
110/125 Vdc	4PDT	11,000	D2RR4A1
120 Vac	4PDT	4430	D2RR4A
220/240 Vac	4PDT	15,720	D2RR4B

3.4

Control Relays and Timers

General Purpose Plug-In Relays

Accessories

D2RF/D2RR Sockets and Accessories

3

Type	Module Size	Nominal Voltage (Max. for Sockets)	Nominal Current	Mounting Style	Wire Size	Wire Connection	Standard Pack	Catalog Number
Socket	B	300	12	DIN rail/panel	14/16 (2) AWG, 2.5/1.5 (2) mm ²	Elevator	1	D2PAL ①
	None	300	10	DIN rail/panel	12/14 (2) AWG, 4/2.5 (2) mm ²	Screw clamping	10	D2PA6
	B	300	10	DIN rail/panel	14/16 (2) AWG, 2.5/1.5 (2) mm ²	Elevator	1	D2PAP ①
	B	300	10	DIN rail/panel	12/14 (2) AWG, 4/2.5 (2) mm ²	Screw clamping	10	D2PA7 ①
	None	300	10	DIN rail/panel	12/14 (2) AWG, 4/2.5 (2) mm ²	Screw clamping	5	D2PA4
Flange mount adapter	—	—	—	Flange	—	—	25	PFC-D2D72
Plastic ejector clip	—	—	—	—	—	—	10	PWC-D24
Metal spring clip	—	—	—	—	—	—	25	PQC-1782
	—	—	—	—	—	—	25	PQC-1342
Hold-down spring	—	—	—	—	—	—	100	PYC-A1
Protection diode	B	6 to 250 Vdc	—	—	—	—	20	MOD-BD250
LED indicator	B	24 Vac/Vdc	—	—	—	—	20	MOD-BLG24
	B	120/240 Vac/Vdc	—	—	—	—	20	MOD-BLG240
MOV suppressor	B	120 Vac/Vdc	—	—	—	—	20	MOD-BMV120
	B	24 Vac/Vdc	—	—	—	—	20	MOD-BMV24
	B	240 Vac/Vdc	—	—	—	—	20	MOD-BMV240
Coil bus jumpers	—	—	—	—	—	—	10	D2PJ1
Plastic DIN rail end stop	—	—	—	—	—	—	25	PPF-P

Note

① Protection category (finger safe), EN 60529: IP20.