

# Plastic Foot switches

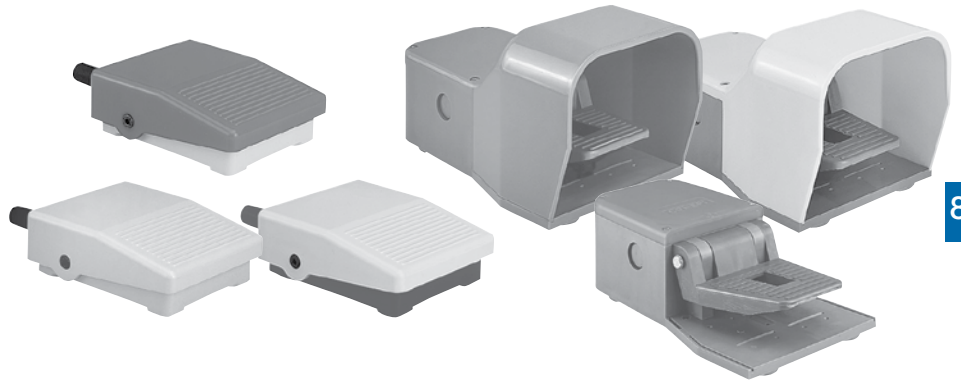

## Foot switches



8

### Description of Mini foot switches

- Reduced dimensions: 100 x 75 x 34 mm.
- Materials: cover and base made of self-extinguishing ABS.
- Color choice: black or grey base; black, grey, yellow or red cover.

### Description of foot switches with covers

- Dimensions: 285 x 140 x 145.
- Materials: base, cover and pedal made of shock resistant Bayblend® FR 90 material (alloyed polycarbonate and ABS).
- Color choice: grey base; grey, yellow or red cover.
- Variations: grey base, half-red cover.  
Especially used for emergency stop function.

Note: this emergency stop function must never contain the «locked in neutral position» device.

UL Listed file #E191693

### Application

Foot switch-operated machines such as: shearing machines, folding machines, spinning lathes, machine tools, wrapping machines, riveting presses, etc.

Foot switches with covers come in three operation formats:

- **Free movement:** contact position follows pedal movement: actuated when the pedal is pushed down, released when pedal is in a state of rest.
- **Foot switch locked in neutral position:** same operation as above, after unlocking the pedal with the end of the foot.
- **Foot switch latched in low position:** same operation as free movement, except that a state of rest is obtained only after having unlatched the pedal with the end of the foot.

## General information

### IPM Mini foot switches, IPS Foot switches with covers Description

#### Application

Foot switch-operated machines such as: shearing machines, folding machines, spinning lathes, machine tools, wrapping machines, riveting presses, etc.

Foot switches with covers come in three operation formats:

- **Free movement** (momentary): contact position follows pedal movement: actuated when the pedal is pushed down, released when pedal is in a state of rest.
- **Foot switch locked in neutral position:** same operation as above, after unlocking the pedal with the end of the foot.
- **Foot switch latched in low position** (maintained): same operation as free movement, except that a state of rest is obtained only after having unlatched the pedal with the end of the foot.

#### Description of Mini foot switches

- Reduced dimensions: 100 x 75 x 34 mm.
- Materials: cover and base made of self-extinguishing ABS.
- Color choice: black or grey base; black, grey, yellow or red cover.

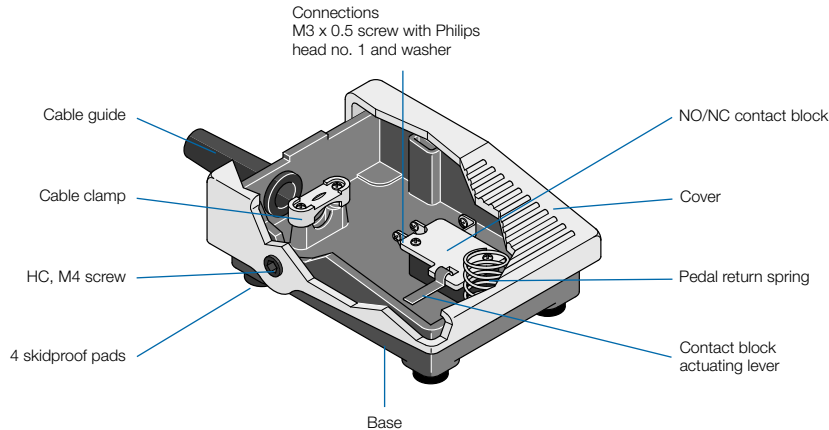

#### Description of foot switches with covers

- Dimensions: 285 x 140 x 145.
- Materials: base, cover and pedal made of shock resistant Bayblend® FR 90 material (alloyed polycarbonate and ABS).
- Color choice: grey base; grey, yellow or red cover.
- Variations: grey base, half-red cover. Especially used for emergency stop function.

Note: this emergency stop function must never contain the «locked in neutral position» device.

- Connecting terminals
- M 3.5 (+, -) Philips no. 1 screw
  - Screw head with captive cable clamp.
  - Markings conform with IEC 947-1, IEC 947-5-1, EN 50 005 and 50 013 standards.

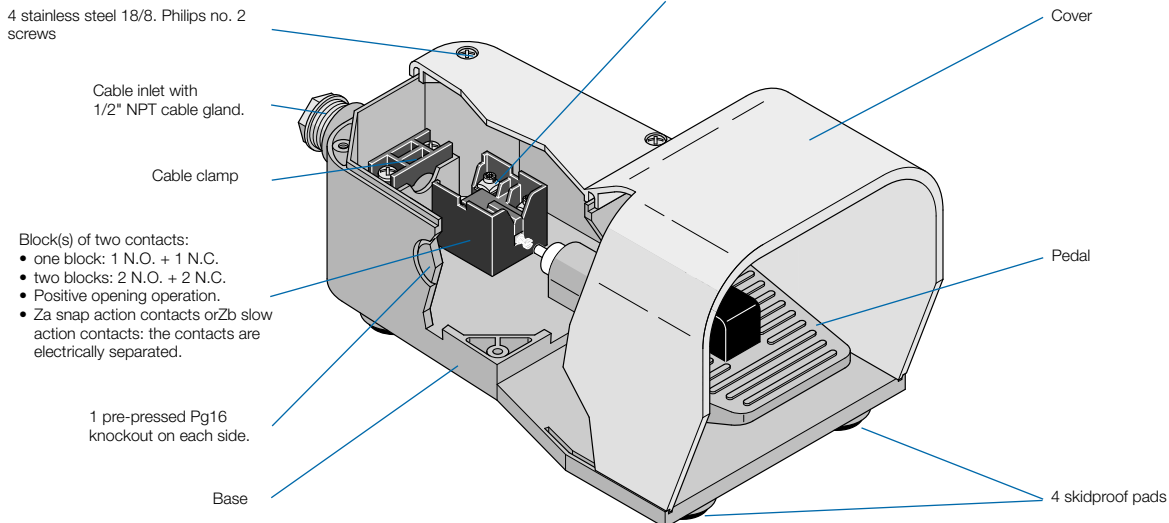

**Comment:** Foot switches with covers can be assembled on a plate and equipped with a transportation handle. Upon request, instead of the handle an emergency stop button can be installed above a tube that allows for connection cable passage.

# Foot switches

## Mini foot switches, IP 40

### IPM Mini foot switches

 N.O. + N.C. contact block		Cover color	Unit weight in kg Packing 1 piece	Catalog number
<b>Black base</b>				
1		Yellow	0.130	IPM1Y
1		Grey	0.130	IPM1G
1		Black	0.130	IPM1B
1		Red	0.130	IPM1R
<b>Grey base</b>				
1		Yellow	0.130	IPM2Y
1		Grey	0.130	IPM2G
1		Black	0.130	IPM2B
1		Red	0.130	IPM2R



IPM1R



IPM1Y



IPM1G



IPM1B



IPM1R

### Catalog number explanation

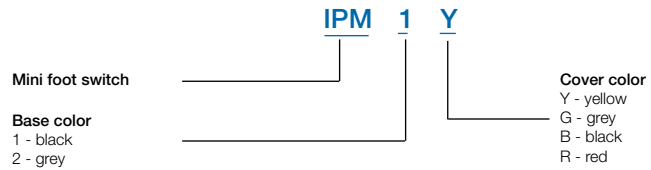

# Foot switches

## Foot switches with covers, IP 65

### IPS foot switches



IPSY1A11



IPSR1A11



IPSG1A11



IPSZ1A11

Contact blocks (set of 1 N.O. + 1 N.C.)				Unit weight in kg	Catalog number
Snap action		Non-overlapping slow action			
Za	Za	Zb	Zb	Packing 1 piece	
<b>Free movement</b>					
1	—	1	—	1.100	IPSA1A11
—	—	—	—	1.100	IPSA1D11
—	1 + 1	—	—	1.100	IPSA1A22
—	—	—	1 + 1	1.100	IPSA1D22
<b>Locked in neutral position</b>					
1	—	1	—	1.100	IPSA2A11
—	—	—	—	1.100	IPSA2D11
—	1 + 1	—	—	1.100	IPSA2A22
—	—	—	1 + 1	1.100	IPSA2D22
<b>Latched in low position</b>					
1	—	1	—	1.100	IPSA3A11
—	—	—	—	1.100	IPSA3D11
—	1 + 1	—	—	1.100	IPSA3A22
—	—	—	1 + 1	1.100	IPSA3D22
<b>Free movement foot switch with half-red cover</b>					
1	—	1	—	0.800	IPSZ1A11
—	—	—	—	0.800	IPSZ1D11
—	1 + 1	—	—	0.800	IPSZ1A22
—	—	—	1 + 1	0.800	IPSZ1D22
<b>Foot switch latched in low position with half-red cover</b>					
1	—	1	—	0.800	IPSZ3A11
—	—	—	—	0.800	IPSZ3D11
—	1 + 1	—	—	0.800	IPSZ3A22
—	—	—	1 + 1	0.800	IPSZ3D22

### Color code

To select a foot switch color, substitute the appropriate color code for the Δ in the catalog number

Yellow	Y
Grey	G
Red	R

### Catalog number explanation

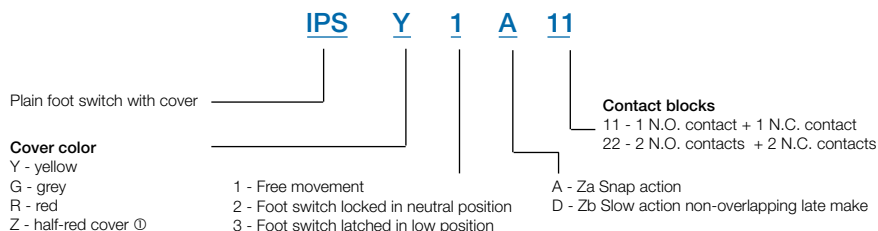

① Incompatible with locked in neutral position function.

# Technical data

## General technical data

	Mini foot switch	Foot switch with cover
<b>Standards</b>	IEC 1058-1	IEC 947-5-1
<b>Certifications &amp; Approvals</b>	—	UL - CSA - BG
<b>Air temperature</b> near the device		
– during operation	°C	– 10 ... + 70
– for storage	°C	– 25 ... + 80
<b>Climatic withstand</b>	—	according to IEC 68-2-3 and salty mist according to IEC 68-2-11
<b>Shock withstand</b> (according to IEC 68-2-27 and EN 60 068-2-27)	g	50g (1/2 sinusoidal shock for 11 ms) no change in contact position
Degree of protection (according to IEC 529 and EN 60 529)	IP 40	IP 65
Actuation torque	N.m	0.25
Operating angle	Degree	2 to 4
Cable inlet	Cable guide ø min. 6mm; ø max. 8.5 mm	Pg 16

## 8 Electrical data

Rated insulation voltage $U_i$	V	250	500 (according to IEC 947-1 and EN 60-947-1) Degree of pollution 3
Rated impulse withstand voltage $U_{imp}$ (according to IEC 947-1 and EN 60 947-1)	kV	1	6
Conventional free air thermal current $I_{th}$ ( $q < 40$ °C)	A	15	10 (according to IEC 947-1)
Short-circuit protection $U_e < 500$ V a.c. - gG (gI) type fuses	A	10	10
Rated operational current	A	3 (250 V a.c.) 0.06 (230 V d.c.)	A 600 (according to UL 508 and CSA C22-2 n° 14) Q 600 (according to UL 508 and CSA C22-2 n° 14)
AC-15 acc. to IEC 947-5-1	24 V 130 V 230 V 240 V 400 V	A A A A A	10 5.5 3.1 3 1.8
DC-13 acc. to IEC 947-5-1	24 V 110 V 250 V	A A A	2.8 0.6 0.27
Resistance between contacts	mΩ	30	25
Connecting terminals		M3 x 0.5 screw with Philips head no. 1 and washer	M3.5 (+, -) screw with Philips head no. 1 with cable clamp
Positive opening operation (according to IEC 947-5-1)		—	⊕
Connecting capacity	1 or 2 x mm <sup>2</sup>	—	0.5 – 2.5
Terminal marking		—	According to EN 50 013
Mechanical durability	Millions of operations	10	30
Electrical durability	Operations	100,000	According to IEC 947-5-1, utilization categories AC-15 and DC-13 (Load factor of 0.5 according to curves below)

### AC-15 – Snap action

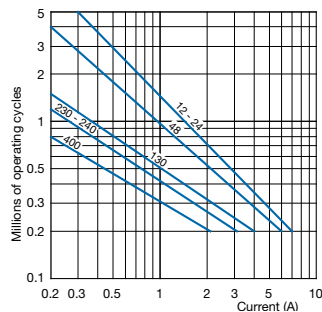

### AC-15 – Slow action

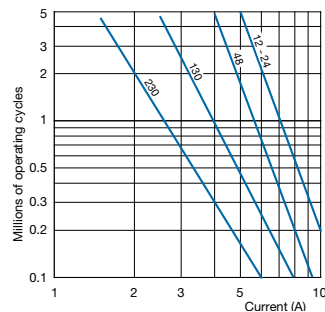

DC-13		Snap action	Slow action
		Power breaking for a durability of 5 million operating cycles	
Voltage	24 V	9.5 W	12 W
Voltage	48 V	6.8 W	9 W
Voltage	110 V	3.6 W	6 W

# Technical data & approximate dimensions

## Mini-footswitches

### IPM Mini foot switches

Base color		Yellow cover	Grey cover	Black cover	Red cover
Black base	Catalog number	IPM1Y	IPM1G	IPM1B	IPM1R
Grey base	Catalog number	IPM2Y	IPM2G	IPM2B	IPM2R
Weight (packing per unit)	kg	0.130	0.130	0.130	0.130

### N.O. + N.C. Contact block

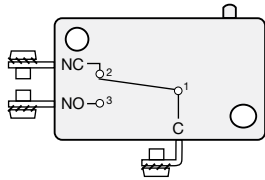

### Dimensions (mm)

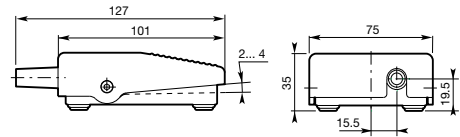

# Technical data & approximate dimensions

## Foot switches with covers

### IPS Foot switches

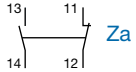
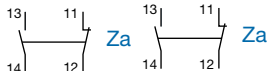
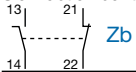
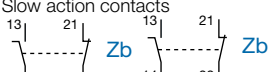
		Free movement	Locked in neutral position	Latched in low position
Snap action contacts 	Catalog number ⊖ (Positive opening operation of the N.C. contact)	IPS1A11 ⊖	IPS2A11 ⊖	IPS3A11 ⊖
Snap action contacts 	Catalog number ⊖ (Positive opening operation of the N.C. contact)	IPS1A22 ⊖	IPS2A22 ⊖	IPS3A22 ⊖
Non-overlapping Slow action contacts 	Catalog number ⊖ (Positive opening operation of the N.C. contact)	IPS1D11 ⊖	IPS2D11 ⊖	IPS3D11 ⊖
Non-overlapping Slow action contacts 	Catalog number ⊖ (Positive opening operation of the N.C. contact)	IPS1D22 ⊖	IPS2D22 ⊖	IPS3D22 ⊖
Weight (packing per unit)	kg	1.10	1.10	1.10

### Dimensions (mm)

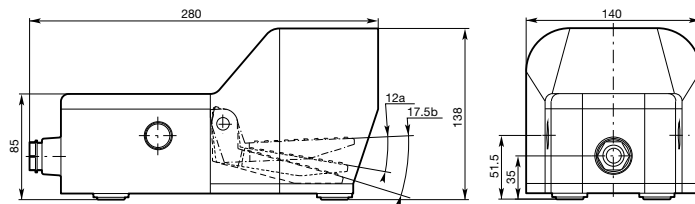

Plain foot switch  
 a = pre-travel  
 b = total travel