

PRODUCT SPECIFICATIONS

41DWx-xxx, 41NB2-xxx, 41AB2-xxx, 41AWx-xxx,
41DB1-5FT, 41DR2-xxx, 41DBR-xxx



110-Style Cross Connect Cat 5e Wiring Products

Wall and Rack-Mount Wiring Blocks and Kits

APPLICATION

Leviton 110-Style Cross Connect Wiring Products are used in building entrance facilities, telecommunications closets, and equipment rooms to provide fixed cross connections for voice, security, and data applications — including high megabit applications when used with Cat 5e rated cabling. Wall version mounts to walls or backboards in 50, 100, or 300-pair densities. Rack version mounts on 19-inch distribution frames or hinged wall-mount brackets.



Wall-Mount Wiring Blocks



C-4 & C-5
Connector Clips

Rack-Mount Wiring Blocks

SPECIFICATION

The cross-connect shall be Cat 5e 110-style wiring blocks, mountable to a wall or backboard to provide 110 termination capable of supporting voice, security, and Cat 5e data applications, including high megabit and shared-sheath applications when used with Cat 5e rated cabling. The 110 rack-mount blocks shall mount to a 19-inch distribution frame or hinged wall-mount bracket. The components shall be UL listed and ANSI/TIA-568-C compliant. Blocks shall support 50, 100, or 300 pair densities with provision for ANSI/TIA-606-B compliant labeling. Plastic bases and blocks shall be made of fire-retardant plastic rated UL 94V-0.

DESIGN CONSIDERATIONS

- Use where space limitations and low cost are factors
- 110-wiring blocks are available with or without standoff legs
- Legs can also be purchased separately (PN# 410L2-xxx)
- Kitted versions include 50, 100, or 300-pair bases with legs, labels, label holders, C-4 or C-5 connector blocks
- Port ID option: use the label strips and holders provided with the 300-pair wiring base, and kit versions of these products
- Mount on wall or backboard
- Route cable bundles either adjacent to wiring bases, or underneath units with legs
- Route individually marked cables from both left and right sides
- 89D mounting bracket is sold separately (40089-00D)

STANDARDS COMPLIANCE

Meets or exceeds all applicable standards: all components are UL listed; complies with ANSI/TIA-568-C.2

PHYSICAL SPECIFICATIONS

Dimensions: See page two

Materials: 110 wiring blocks are made of fire-retardant plastic rated UL 94V-0; C-4 and C-5 connector blocks are made of fire-retardant plastic rated UL 94V-0 with solder plated IDCs; rack-mount panel back plates are made of painted black 16-gauge steel.

WARRANTY INFORMATION

For a copy of Leviton product warranties, visit www.leviton.com/ warranty.

Leviton Network Solutions

2222 - 222nd St. SE
Bothell, WA 98021-4416

tel 1-800-824-3005
tel +1-425-486-2222
appeng@leviton.com
www.leviton.com

Asia / Pacific

T +1.631.812.6228
E infoasean@leviton.com

Europe

T +33.6.8869.1380
E infoeurope@leviton.com

Canada

T +1.514.954.1840
E pcservice@leviton.com

India / SAARC

T +971.4.886.4722
E infoindia@leviton.com

Caribbean

T +1.954.593.1896
E infocaribbean@leviton.com

Mexico

T +52.55.5082.1040
E lsamarketing@leviton.com

China

T +852.2774.9876
E infochina@leviton.com

Middle East & Africa

T +971.4.886.4722
E lmeinfo@leviton.com

Colombia

T +57.1.743.6045
E infocolombia@leviton.com

South Korea

T +82.2.3273.9963
E infokorea@leviton.com

PRODUCT SPECIFICATIONS
41DWx-xxx, 41NB2-xxx, 41AB2-xxx, 41AWx-xxx,
41DB1-5FT, 41DR2-xxx, 41DBR-xxx



ELECTRONIC FILES

For CAD files, technical specs, or technical drawings (.DXF, .DWG), visit www.leviton.com.

41DWx-xxx, 41NB2-xxx, 41AB2-xxx, 41AWx-xxx, 41DB1-5FT, 41DR2-xxx, 41DBR-xxx

50-Pair Wiring Block (without legs)

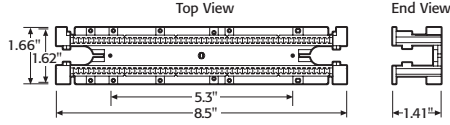

100-Pair Rack-Mount Wiring Block

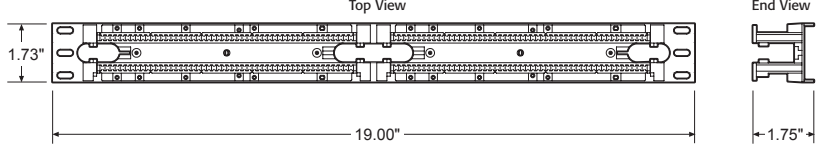

100-Pair Wiring Block (without legs)

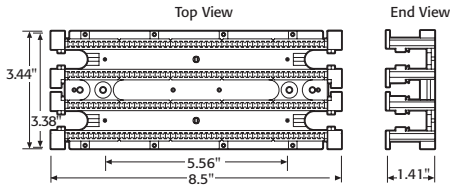

200-Pair Rack-Mount Wiring Block

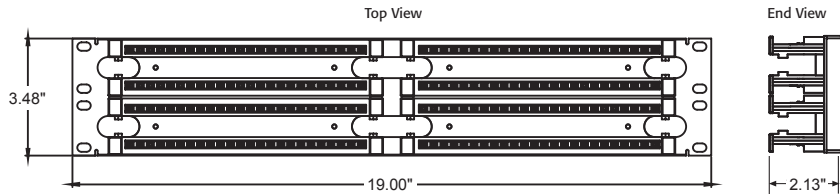

50-Pair Wiring Block (with legs)

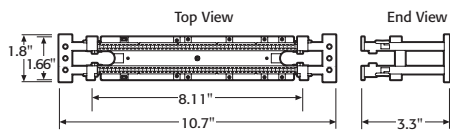

300-Pair Rack-Mount Wiring Block

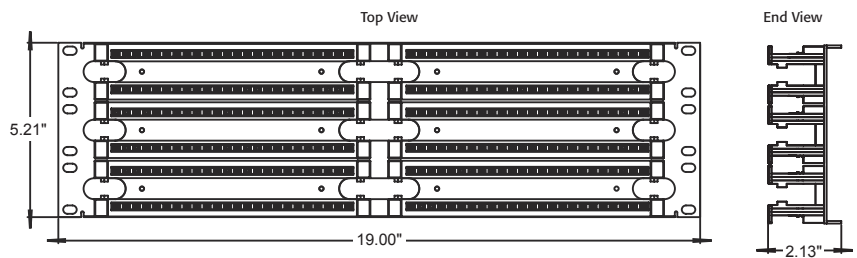

100-Pair Wiring Block (with legs)

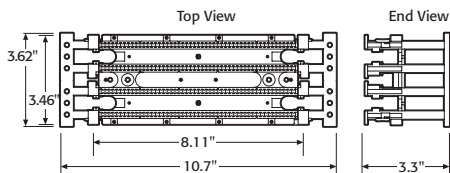

50-Pair 89D Bracket Compatible Wiring Block

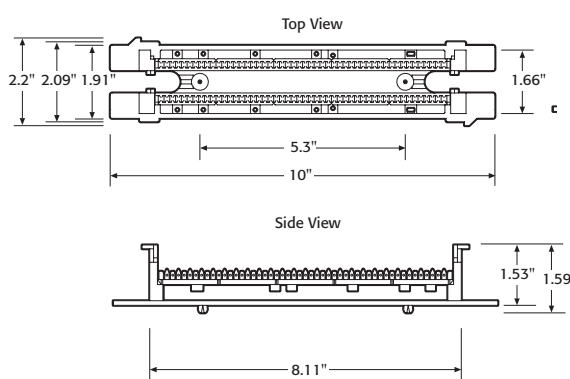

300-Pair Wiring Block (with legs)

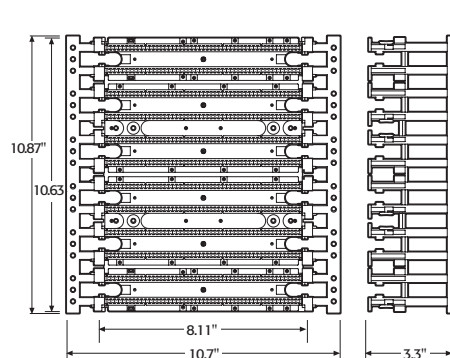

Leviton Network Solutions
 2222 - 222nd St. SE
 Bothell, WA 98021-4416

Asia / Pacific
 T +1.631.812.6228
 E infoasean@leviton.com

Canada
 T +1.514.954.1840
 E pcservice@leviton.com

Caribbean
 T +1.954.593.1896
 E infocaribbean@leviton.com

China
 T +852.2774.9876
 E infochina@leviton.com

Colombia
 T +57.1.743.6045
 E infocolombia@leviton.com

tel 1-800-824-3005
 tel +1-425-486-2222
appeng@leviton.com
www.leviton.com

Europe
 T +33.6.8869.1380
 E infoeurope@leviton.com

India / SAARC
 T +971.4.886.4722
 E infoindia@leviton.com

Mexico
 T +52.55.5082.1040
 E lsamarketing@leviton.com

Middle East & Africa
 T +971.4.886.4722
 E lmeinfo@leviton.com

South Korea
 T +82.2.3273.9963
 E infokorea@leviton.com

PRODUCT SPECIFICATIONS

**41DWx-xxx, 41NB2-xxx, 41AB2-xxx, 41AWx-xxx,
41DB1-5FT, 41DR2-xxx, 41DBR-xxx**



41DWx-xxx, 41NB2-xxx, 41AB2-xxx, 41AWx-xxx, 41DB1-5FT, 41DR2-xxx, 41DBR-xxx

PART NUMBERS	
DESCRIPTION	PART NO.
50-Pair Wall-Mount Wiring Block without legs	41DW1-050
100-Pair Wall-Mount Wiring Block without legs	41DW2-100
50-Pair Wall-Mount Wiring Block with legs	41AW1-050
100-Pair Wall-Mount Wiring Block with legs	41AW2-100
300-Pair Wall-Mount Wiring Block with legs	41AW2-300
100-Pair Wall-Mount Wiring Block Kit w/ C-4 clips	41AB2-1F4
300-Pair Wall-Mount Wiring Block Kit w/ C-4 clips	41AB2-3F4
100-Pair Wall-Mount Wiring Block Kit w/ C-5 clips	41AB2-1F5
300-Pair Wall-Mount Wiring Block Kit w/ C-5 clips	41AB2-3F5
100-Pair Wall-Mount Wiring Block Kit w/o legs w/ C-4 clips	41NB2-1F4
100-Pair Wall-Mount Wiring Block Kit w/o legs w/ C-5 clips	41NB2-1F5
100-Pair Rack-Mount Wiring Block	41DR2-100
200-Pair Rack-Mount Wiring Block	41DR2-200
300-Pair Rack-Mount Wiring Block	41DR2-300
100-Pair Rack-Mount Wiring Block Kit w/ C-4 clips	41DBR-1F4
200-Pair Rack-Mount Wiring Block Kit w/ C-4 clips	41DBR-2F4
300-Pair Rack-Mount Wiring Block Kit w/ C-4 clips	41DBR-3F4
100-Pair Rack-Mount Wiring Block Kit w/ C-5 clips	41DBR-1F5
200-Pair Rack-Mount Wiring Block Kit w/ C-5 clips	41DBR-2F5
300-Pair Rack-Mount Wiring Block Kit w/ C-5 clips	41DBR-3F5
50-Pair 89D Bracket Compatible Wiring Block UNIT (89D Bracket sold separately)	41DW1-589
50-Pair 89D Bracket Compatible Wiring Block KIT with C-4/C-5 clips (89D Bracket sold separately)	41DB1-5FT
89D Bracket	40089-00D
C-4 Connector Clips	49104-IDC
C-5 Connector Clips	49105-IDC
Legs, 2 each, for use with 41DW1 only	410L2-050
Legs, 2 each, for use with 41DW2 only	410L2-100



Leviton Network Solutions
2222 - 222nd St. SE
Bothell, WA 98021-4416

Asia / Pacific
T +1.631.812.6228
E infoasean@leviton.com

Canada
T +1.514.954.1840
E pcservice@leviton.com

Caribbean
T +1.954.593.1896
E infocaribbean@leviton.com

China
T +852.2774.9876
E infochina@leviton.com

Colombia
T +57.1.743.6045
E infocolombia@leviton.com

tel 1-800-824-3005
tel +1-425-486-2222
appeng@leviton.com
www.leviton.com

Europe
T +33.6.8869.1380
E infoeurope@leviton.com

India / SAARC
T +971.4.886.4722
E infoindia@leviton.com

Mexico
T +52.55.5082.1040
E lsamarketing@leviton.com

Middle East & Africa
T +971.4.886.4722
E lmeinfo@leviton.com

South Korea
T +82.2.3273.9963
E infokorea@leviton.com