



Plugmold systems are available in a variety of colors and configurations.

Plugmold® Raceway & Multioutlet Assemblies

Plugmold® Multioutlet Systems are available in a wide variety of lengths and fittings and in a variety of finishes to provide versatile solutions for many applications. Plugmold options include single or alternating circuits, standard or isolated ground receptacles, GFCI protection, tamper-resistant protection, USB charging, Snapicoil® harnesses of prewired receptacles, and cord-ended units.

Plugmold® Multioutlet Systems are available in black or ivory ScuffCoat™ finish, painted white or gray enamel steel, stylish stainless steel, anodized aluminum and durable textured ivory nonmetallic. The painted steel product works with many types of decor and is paintable to integrate with most color schemes. Durable stainless steel and anodized aluminum Plugmold products are corrosion-resistant, making them ideal for labs.

PRODUCTS: PLUGMOLD 2000 SERIES, 2400 SERIES, AL2000 SERIES, NM2000 SERIES, NM2400 SERIES

Features & Benefits

- **Compact, low profile appearance.** Enhanced aesthetics and ideal for installations within minimal spaces.
- **Multiple finishes.** Choose from black or ivory ScuffCoat, white or gray painted enamel or durable stainless steel finishes.
- **USB 2.0 & 3.0 compatible charging.** Dual-port charging modules share 2.4 amps of charging capacity and can charge multiple phones, tablets or other mobile devices at the same time.
- **GFCI protection.**
- **Tamper-resistance protection.** Prevents the accidental insertion of foreign objects into receptacles reducing the risk of shocks or electrocution. Meets 2014 NEC section 406 requirements.
- **Single, alternating circuit, and isolated ground wiring options available.** Wiring options to meet virtually any job or environment requirement.
- **Variety of lengths.** Installed power and USB charging in multiple lengths to meet space and location requirements.
- **Full range of fittings.** Provide flexibility for multiple installation options or integrations with 2000 or 2400 Series Raceway systems.
- **Snapicoil harnesses with different lengths and receptacle spacing.** Custom solution available for large or specific use electrical installations.
- **Customization available.** Plugmold products can be modified to accommodate virtually any application or aesthetic need.
- **Receptacle spacing options.** Select the right configuration for your application.
- **cULus Listed.** Safety and reliability in the applications.

Vertical Markets

- Commercial
- Education
- Entertainment
- Healthcare
- Retail
- Hospitality



Compliance

cULus Listed Base & Blank Cover: File E4376 Guide RJBT

Multioutlet Assemblies: File E15191 Guide PVGT

Fittings: File E41751 Guide RJPR

Base & Blank Cover: Meets Article 386 of NEC

Plugmold Strips: Meets Article 380 of NEC

Plugmold Multioutlet Systems Quick Selection Guide

FABRICATION	PROFILE	FINISH OPTIONS	LENGTHS	WIRING CONFIGS.	OUTLET OPTIONS		OPTIONS	
					O.C. SPACING	QUANTITY		
Steel	2000 Series	Black Scuffcoat	2' (610mm) *	GB,	6" (152mm)	4	Single	<ul style="list-style-type: none"> • Hard-Wired models • Cord-Ended models • USB Charging models • Plug-In model • GFCI Protection • Tamper-Resistant
		Ivory Scuffcoat	3' (910mm)	GB/USB,	9" (229mm)	5	Single	
		Gray Enamel	5' (1.5m)	GBA	12" (305mm)	6	Single	
		White Enamel	6' (1.8m)	IG	18" (457mm)	8	Single	
		Stainless Steel			24" (608mm)	10	Single	
						12	Single	
						3	Duplex	
						4	Duplex	
						5	Duplex	
						6	Duplex	
Steel	2400 Series	Ivory Scuffcoat	3' (910mm)	GB,	6" (152mm)	4	Single	<ul style="list-style-type: none"> • Hard-Wired models • Cord-Ended models
			5' (1.5m)	GBA	12" (305mm)	5	Single	
			6' (1.8m)	IG	18" (457mm)	6	Single	
					24" (608mm)	10	Single	
						12	Single	
						3	Duplex	
						4	Duplex	
						5	Duplex	
						6	Duplex	
			Aluminum	AL2000 Series	Anodized	4' (1.2m)	GB,	
5' (1.5m)	GBA	12" (305mm)				5	Single	
6' (1.8m)	GB/USB,	18" (457mm)				6	Single	
	IG					10	Single	
						12	Single	
Nonmetallic	NM2000 Series	Ivory PVC	4' (1.2m)	GB,	9" (229mm)	2	Duplex	<ul style="list-style-type: none"> • Hard-Wired models • Cord-Ended models
			5' (1.5m)	GBA	12" (305mm)	4	Duplex	
			6' (1.8m)	IG	15" (381mm)	5	Duplex	
					18" (457mm)	6	Duplex	
					30" (760mm)	8	Duplex	
Nonmetallic	NM2400 Series	Ivory PVC	3' (910mm)	GB,	12" (305mm)	2	Duplex	<ul style="list-style-type: none"> • Hard-Wired models • Cord-Ended models
			4' (1.2m)	GBA	18" (457mm)	3	Duplex	
			5' (1.5m)		30" (760mm)	4	Duplex	
			6' (1.8m)			5	Duplex	
						6	Duplex	

CUSTOM PLUGMOLD

Plugmold is one of our most frequently requested custom products. From airports, to trains, to classrooms, dormitories or residences, anywhere multiple access to power or USB charging is needed. Custom receptacle spacing options, custom colors, wiring modifications, or any number of custom configurations are available for special applications. Contact the factory to discuss our capabilities and why Plugmold is often the best option for locations requiring multiple access to power or USB charging.



Steel Plugmold® Multioutlet Systems

Steel Plugmold Multioutlet Systems are available in a wide range of lengths and finishes to provide a versatile solution for many applications. Options include versions with single or alternating circuits, standard, or isolated ground receptacles, Snapicoil® harnesses of prewired receptacles, USB charging options, GFCI protection, tamper-resistance, plug-in and cord-ended units.

Steel Plugmold® Multioutlet Systems are available in black or ivory ScuffCoat™ finish, painted white or gray enamel finish, or stylish stainless steel. The enamel finishes work with many types of decor or can be painted to blend with most color schemes. Stainless steel Plugmold raceway is both durable and aesthetically pleasing.



Steel Plugmold systems are available in a variety of colors and configurations.

Plugmold 2000 Series Steel Multioutlet Systems

Plugmold 2000 Series Wire Fill Capacities for Power				
CABLE TYPE	WIRE SIZE THHN/THWN	O.D.		NO. OF CONDUCTORS (40% FILL) 2000
		Inches	(mm)	
POWER WIRING WITHOUT DEVICES	12 AWG	0.130	(3.3)	7*
	14 AWG	0.111	(2.8)	7*
POWER WIRING WITH DEVICES (Plugmold Series)	12 AWG	0.122	(3.1)	5**
	14 AWG	0.105	(2.7)	5**



*Wire capacity limited to maximum of seven conductors due to .025" (.6mm) material thickness of cover.

**Including one hot, neutral, and ground wire from the receptacle.

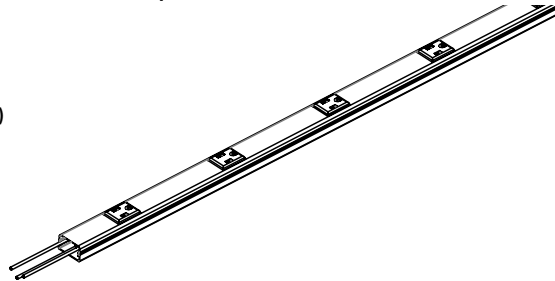
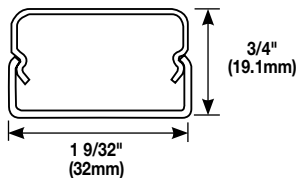

Steel Plugmold Multioutlet Systems are ideal for use in homes, dormitories and office applications, anywhere convenient access to power or USB charging is needed.

Plugmold 2000 Series Steel Multioutlet Systems Ordering Information

Plugmold 2000 Series Steel Part Numbering System

2000 Series Steel Plugmold Series – Example: G20GB306



G

COLOR:

Black = **BK**
Gray = **G**
Ivory = **V**
White = **WH**
Stainless = **S**

20

RACEWAY:

2000 = **20**

GB

WIRING CONFIGURATION:

GB = **GB**
GBA = **GBA**
IG = **IG***

* Stainless steel only.
** 6' lengths only.

3

LENGTH:

24" (608mm) = **2***
36" (915mm) = **3**
60" (1.5m) = **5**
72" (1.8m) = **6**

06

CENTER DISTANCE:

6" (152mm) = **6**
9" (229mm) = **9****
12" (305mm) = **12**
18" (457mm) = **18**

NOTE: Not all combinations of color, wiring configurations, length, and center distance are available as standard products. For additional information, contact Wiremold Technical Support at 1-800-621-0049.

NOTE: Color codes: "V" for Ivory ScuffCoat™ finish, "BK" for Black ScuffCoat™ finish, "G" for Gray enamel finish, "WH" for white enamel finish, and "S" for stainless steel. Receptacle colors match extrusion colors except for stainless steel which has black receptacles and isolated ground versions which have orange receptacles.

* All 2000 Series Plugmold products include two (2) 2010B Blank End Fittings and one (1) 2001 Base Coupling unless otherwise indicated in the product description.

Plugmold 2000 Series Wiring Configurations



GB Series:

3-wire, #12 THHN (1 hot, 1 neutral and 1 ground), 1 circuit; has insulated grounding conductor.



GBA Series:

4-wire, #12 THHN (2 hot, 1 neutral and 1 ground), 2 circuit; outlets wired alternately; has insulated grounding conductor.



IG Series:

3-wire, #12 THHN (1 hot, 1 neutral and 1 ground), 1 circuit; has insulated-isolated grounding conductor. Orange receptacles.

With Snapicoil

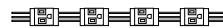

GB Series:

3-wire, #12 THHN (1 hot, 1 neutral and 1 ground), 1 circuit; has insulated grounding conductor.



GBA Series:

4-wire, #12 THHN (2 hot, 1 neutral and 1 ground), 2 circuit; outlets wired alternately; has insulated grounding conductor.

NOTE: SNAPICOIL REELS on custom order. Snapicoil harness is available on reels if lengths greater than 50' are needed, or if multiple lengths are required for production-type jobs. The maximum length per reel is 240' for Snapicoil with outlets 12" and 18" on centers; 500' with outlets 30" on center. Packaging includes the necessary number of lengths of base, holecut cover, wire clips, and couplings for complete installation. Price and delivery information should be obtained prior to specifying or ordering. To specify or order, add "R" to the Snapicoil number. Ex: V20GB12R. Other outlet spacings available on custom order.

Receptacles are made from high impact thermoplastic. Snapicoil packaging includes the necessary lengths of 2000B Base, 2000C Hole Cut Cover, 2000WC Wire Clips, and 2001 Couplings for complete installation.

Plugmold 2000 Series Steel Multioutlet Systems Ordering Information

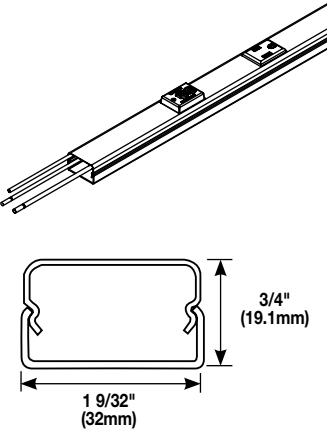
Product	Description/Specifications																																																																																															
GFCI Plugmold 	<p>GFCI Module provides downstream protection for all outlets and connections. Available in 3' (914mm), 5' (1.5m) and 6' (1.8m) lengths with 6" (152mm) receptacle spacing. 15A tamper-resistant receptacles. 3-wire, #12 THHN (1 hot, 1 neutral, and insulated ground conductor). .040" (1.0mm) steel housing. Packed 2 per carton. Each unit supplied with one (1) Coupling and two (2) Blank End Fittings. GFCI Class A 20A 125V 60Hz.</p>																																																																																															
	<table border="1"> <thead> <tr> <th>CATALOG NO.</th> <th>FINISH</th> <th>LENGTH Feet (mm)</th> <th>WIRING CONFIG</th> <th>CENTER DISTANCE Inches (mm)</th> <th>OUTLETS QUANTITY & TYPE</th> </tr> </thead> <tbody> <tr><td>WH20GB306TRGFI6</td><td>White</td><td>3' (915mm)</td><td>GB</td><td>6" (152mm)</td><td>1 GFCI, 5 Single 15A</td></tr> <tr><td>BK20GB306TRGFI6</td><td>Black</td><td>3' (915mm)</td><td>GB</td><td>6" (152mm)</td><td>1 GFCI, 5 Single 15A</td></tr> <tr><td>V20GB306TRGFI6</td><td>Ivory</td><td>3' (915mm)</td><td>GB</td><td>6" (152mm)</td><td>1 GFCI, 5 Single 15A</td></tr> <tr><td>G20GB306TRGFI6</td><td>Gray</td><td>3' (915mm)</td><td>GB</td><td>6" (152mm)</td><td>1 GFCI, 5 Single 15A</td></tr> <tr><td>S20GB306TRGFI6</td><td>Stainless</td><td>3' (915mm)</td><td>GB</td><td>6" (152mm)</td><td>1 GFCI, 5 Single 15A</td></tr> <tr><td>WH20GB506TRGFI6</td><td>White</td><td>5' (1.5m)</td><td>GB</td><td>6" (152mm)</td><td>1 GFCI, 9 Single 15A</td></tr> <tr><td>BK20GB506TRGFI6</td><td>Black</td><td>5' (1.5m)</td><td>GB</td><td>6" (152mm)</td><td>1 GFCI, 9 Single 15A</td></tr> <tr><td>V20GB506TRGFI6</td><td>Ivory</td><td>5' (1.5m)</td><td>GB</td><td>6" (152mm)</td><td>1 GFCI, 9 Single 15A</td></tr> <tr><td>G20GB506TRGFI6</td><td>Gray</td><td>5' (1.5m)</td><td>GB</td><td>6" (152mm)</td><td>1 GFCI, 9 Single 15A</td></tr> <tr><td>S20GB506TRGFI6</td><td>Stainless</td><td>5' (1.5m)</td><td>GB</td><td>6" (152mm)</td><td>1 GFCI, 9 Single 15A</td></tr> <tr><td>WH20GB606TRGFI6</td><td>White</td><td>6' (1.8m)</td><td>GB</td><td>6" (152mm)</td><td>1 GFCI, 11 Single 15A</td></tr> <tr><td>BK20GB606TRGFI6</td><td>Black</td><td>6' (1.8m)</td><td>GB</td><td>6" (152mm)</td><td>1 GFCI, 11 Single 15A</td></tr> <tr><td>V20GB606TRGFI6</td><td>Ivory</td><td>6' (1.8m)</td><td>GB</td><td>6" (152mm)</td><td>1 GFCI, 11 Single 15A</td></tr> <tr><td>G20GB606TRGFI6</td><td>Gray</td><td>6' (1.8m)</td><td>GB</td><td>6" (152mm)</td><td>1 GFCI, 11 Single 15A</td></tr> <tr><td>S20GB606TRGFI6</td><td>Stainless</td><td>6' (1.8m)</td><td>GB</td><td>6" (152mm)</td><td>1 GFCI, 11 Single 15A</td></tr> </tbody> </table>	CATALOG NO.	FINISH	LENGTH Feet (mm)	WIRING CONFIG	CENTER DISTANCE Inches (mm)	OUTLETS QUANTITY & TYPE	WH20GB306TRGFI6	White	3' (915mm)	GB	6" (152mm)	1 GFCI, 5 Single 15A	BK20GB306TRGFI6	Black	3' (915mm)	GB	6" (152mm)	1 GFCI, 5 Single 15A	V20GB306TRGFI6	Ivory	3' (915mm)	GB	6" (152mm)	1 GFCI, 5 Single 15A	G20GB306TRGFI6	Gray	3' (915mm)	GB	6" (152mm)	1 GFCI, 5 Single 15A	S20GB306TRGFI6	Stainless	3' (915mm)	GB	6" (152mm)	1 GFCI, 5 Single 15A	WH20GB506TRGFI6	White	5' (1.5m)	GB	6" (152mm)	1 GFCI, 9 Single 15A	BK20GB506TRGFI6	Black	5' (1.5m)	GB	6" (152mm)	1 GFCI, 9 Single 15A	V20GB506TRGFI6	Ivory	5' (1.5m)	GB	6" (152mm)	1 GFCI, 9 Single 15A	G20GB506TRGFI6	Gray	5' (1.5m)	GB	6" (152mm)	1 GFCI, 9 Single 15A	S20GB506TRGFI6	Stainless	5' (1.5m)	GB	6" (152mm)	1 GFCI, 9 Single 15A	WH20GB606TRGFI6	White	6' (1.8m)	GB	6" (152mm)	1 GFCI, 11 Single 15A	BK20GB606TRGFI6	Black	6' (1.8m)	GB	6" (152mm)	1 GFCI, 11 Single 15A	V20GB606TRGFI6	Ivory	6' (1.8m)	GB	6" (152mm)	1 GFCI, 11 Single 15A	G20GB606TRGFI6	Gray	6' (1.8m)	GB	6" (152mm)	1 GFCI, 11 Single 15A	S20GB606TRGFI6	Stainless	6' (1.8m)	GB	6" (152mm)
CATALOG NO.	FINISH	LENGTH Feet (mm)	WIRING CONFIG	CENTER DISTANCE Inches (mm)	OUTLETS QUANTITY & TYPE																																																																																											
WH20GB306TRGFI6	White	3' (915mm)	GB	6" (152mm)	1 GFCI, 5 Single 15A																																																																																											
BK20GB306TRGFI6	Black	3' (915mm)	GB	6" (152mm)	1 GFCI, 5 Single 15A																																																																																											
V20GB306TRGFI6	Ivory	3' (915mm)	GB	6" (152mm)	1 GFCI, 5 Single 15A																																																																																											
G20GB306TRGFI6	Gray	3' (915mm)	GB	6" (152mm)	1 GFCI, 5 Single 15A																																																																																											
S20GB306TRGFI6	Stainless	3' (915mm)	GB	6" (152mm)	1 GFCI, 5 Single 15A																																																																																											
WH20GB506TRGFI6	White	5' (1.5m)	GB	6" (152mm)	1 GFCI, 9 Single 15A																																																																																											
BK20GB506TRGFI6	Black	5' (1.5m)	GB	6" (152mm)	1 GFCI, 9 Single 15A																																																																																											
V20GB506TRGFI6	Ivory	5' (1.5m)	GB	6" (152mm)	1 GFCI, 9 Single 15A																																																																																											
G20GB506TRGFI6	Gray	5' (1.5m)	GB	6" (152mm)	1 GFCI, 9 Single 15A																																																																																											
S20GB506TRGFI6	Stainless	5' (1.5m)	GB	6" (152mm)	1 GFCI, 9 Single 15A																																																																																											
WH20GB606TRGFI6	White	6' (1.8m)	GB	6" (152mm)	1 GFCI, 11 Single 15A																																																																																											
BK20GB606TRGFI6	Black	6' (1.8m)	GB	6" (152mm)	1 GFCI, 11 Single 15A																																																																																											
V20GB606TRGFI6	Ivory	6' (1.8m)	GB	6" (152mm)	1 GFCI, 11 Single 15A																																																																																											
G20GB606TRGFI6	Gray	6' (1.8m)	GB	6" (152mm)	1 GFCI, 11 Single 15A																																																																																											
S20GB606TRGFI6	Stainless	6' (1.8m)	GB	6" (152mm)	1 GFCI, 11 Single 15A																																																																																											

NOTE: GFCI module does not contain an outlet.

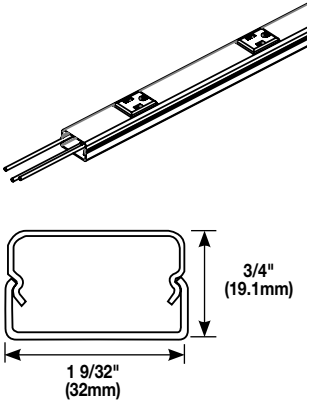
Product	Description/Specifications																																																																																															
Tamper-Resistant Plugmold 	<p>Receptacles prevent the accidental insertion of foreign objects into receptacles reducing the risk of shocks or electrocution. Meets 2014 NEC section 406 requirements. Available in 3' (914mm), 5' (1.5m) and 6' (1.8m) lengths with 6" (152mm) receptacle spacing. 15A tamper-resistant receptacles. 3-wire, #12 THHN (1 hot, 1 neutral, and insulated ground conductor). .040" (1.0mm) steel housing. Packed 2 per carton. Each unit supplied with one (1) Coupling and two (2) Blank End Fittings.</p>																																																																																															
	<table border="1"> <thead> <tr> <th>CATALOG NO.</th> <th>FINISH</th> <th>LENGTH Feet (mm)</th> <th>WIRING CONFIG</th> <th>CENTER DISTANCE Inches (mm)</th> <th>OUTLETS QUANTITY & TYPE</th> </tr> </thead> <tbody> <tr><td>WH20GB306TR</td><td>White</td><td>3' (915mm)</td><td>GB</td><td>6" (152mm)</td><td>6 Single TR 15A</td></tr> <tr><td>BK20GB306TR</td><td>Black</td><td>3' (915mm)</td><td>GB</td><td>6" (152mm)</td><td>6 Single TR 15A</td></tr> <tr><td>V20GB306TR</td><td>Ivory</td><td>3' (915mm)</td><td>GB</td><td>6" (152mm)</td><td>6 Single TR 15A</td></tr> <tr><td>G20GB306TR</td><td>Gray</td><td>3' (915mm)</td><td>GB</td><td>6" (152mm)</td><td>6 Single TR 15A</td></tr> <tr><td>S20GB306TR</td><td>Stainless</td><td>3' (915mm)</td><td>GB</td><td>6" (152mm)</td><td>6 Single TR 15A</td></tr> <tr><td>WH20GB506TR</td><td>White</td><td>5' (1.5m)</td><td>GB</td><td>6" (152mm)</td><td>9 Single TR 15A</td></tr> <tr><td>BK20GB506TR</td><td>Black</td><td>5' (1.5m)</td><td>GB</td><td>6" (152mm)</td><td>9 Single TR 15A</td></tr> <tr><td>V20GB506TR</td><td>Ivory</td><td>5' (1.5m)</td><td>GB</td><td>6" (152mm)</td><td>9 Single TR 15A</td></tr> <tr><td>G20GB506TR</td><td>Gray</td><td>5' (1.5m)</td><td>GB</td><td>6" (152mm)</td><td>9 Single TR 15A</td></tr> <tr><td>S20GB506TR</td><td>Stainless</td><td>5' (1.5m)</td><td>GB</td><td>6" (152mm)</td><td>9 Single TR 15A</td></tr> <tr><td>WH20GB606TR</td><td>White</td><td>6' (1.8m)</td><td>GB</td><td>6" (152mm)</td><td>11 Single TR 15A</td></tr> <tr><td>BK20GB606TR</td><td>Black</td><td>6' (1.8m)</td><td>GB</td><td>6" (152mm)</td><td>11 Single TR 15A</td></tr> <tr><td>V20GB606TR</td><td>Ivory</td><td>6' (1.8m)</td><td>GB</td><td>6" (152mm)</td><td>11 Single TR 15A</td></tr> <tr><td>G20GB606TR</td><td>Gray</td><td>6' (1.8m)</td><td>GB</td><td>6" (152mm)</td><td>11 Single TR 15A</td></tr> <tr><td>S20GB606TR</td><td>Stainless</td><td>6' (1.8m)</td><td>GB</td><td>6" (152mm)</td><td>11 Single TR 15A</td></tr> </tbody> </table>	CATALOG NO.	FINISH	LENGTH Feet (mm)	WIRING CONFIG	CENTER DISTANCE Inches (mm)	OUTLETS QUANTITY & TYPE	WH20GB306TR	White	3' (915mm)	GB	6" (152mm)	6 Single TR 15A	BK20GB306TR	Black	3' (915mm)	GB	6" (152mm)	6 Single TR 15A	V20GB306TR	Ivory	3' (915mm)	GB	6" (152mm)	6 Single TR 15A	G20GB306TR	Gray	3' (915mm)	GB	6" (152mm)	6 Single TR 15A	S20GB306TR	Stainless	3' (915mm)	GB	6" (152mm)	6 Single TR 15A	WH20GB506TR	White	5' (1.5m)	GB	6" (152mm)	9 Single TR 15A	BK20GB506TR	Black	5' (1.5m)	GB	6" (152mm)	9 Single TR 15A	V20GB506TR	Ivory	5' (1.5m)	GB	6" (152mm)	9 Single TR 15A	G20GB506TR	Gray	5' (1.5m)	GB	6" (152mm)	9 Single TR 15A	S20GB506TR	Stainless	5' (1.5m)	GB	6" (152mm)	9 Single TR 15A	WH20GB606TR	White	6' (1.8m)	GB	6" (152mm)	11 Single TR 15A	BK20GB606TR	Black	6' (1.8m)	GB	6" (152mm)	11 Single TR 15A	V20GB606TR	Ivory	6' (1.8m)	GB	6" (152mm)	11 Single TR 15A	G20GB606TR	Gray	6' (1.8m)	GB	6" (152mm)	11 Single TR 15A	S20GB606TR	Stainless	6' (1.8m)	GB	6" (152mm)
CATALOG NO.	FINISH	LENGTH Feet (mm)	WIRING CONFIG	CENTER DISTANCE Inches (mm)	OUTLETS QUANTITY & TYPE																																																																																											
WH20GB306TR	White	3' (915mm)	GB	6" (152mm)	6 Single TR 15A																																																																																											
BK20GB306TR	Black	3' (915mm)	GB	6" (152mm)	6 Single TR 15A																																																																																											
V20GB306TR	Ivory	3' (915mm)	GB	6" (152mm)	6 Single TR 15A																																																																																											
G20GB306TR	Gray	3' (915mm)	GB	6" (152mm)	6 Single TR 15A																																																																																											
S20GB306TR	Stainless	3' (915mm)	GB	6" (152mm)	6 Single TR 15A																																																																																											
WH20GB506TR	White	5' (1.5m)	GB	6" (152mm)	9 Single TR 15A																																																																																											
BK20GB506TR	Black	5' (1.5m)	GB	6" (152mm)	9 Single TR 15A																																																																																											
V20GB506TR	Ivory	5' (1.5m)	GB	6" (152mm)	9 Single TR 15A																																																																																											
G20GB506TR	Gray	5' (1.5m)	GB	6" (152mm)	9 Single TR 15A																																																																																											
S20GB506TR	Stainless	5' (1.5m)	GB	6" (152mm)	9 Single TR 15A																																																																																											
WH20GB606TR	White	6' (1.8m)	GB	6" (152mm)	11 Single TR 15A																																																																																											
BK20GB606TR	Black	6' (1.8m)	GB	6" (152mm)	11 Single TR 15A																																																																																											
V20GB606TR	Ivory	6' (1.8m)	GB	6" (152mm)	11 Single TR 15A																																																																																											
G20GB606TR	Gray	6' (1.8m)	GB	6" (152mm)	11 Single TR 15A																																																																																											
S20GB606TR	Stainless	6' (1.8m)	GB	6" (152mm)	11 Single TR 15A																																																																																											

NOTE: Color codes: "V" for Ivory ScuffCoat™ finish, "BK" for Black ScuffCoat™ finish, "G" for Gray enamel finish, "WH" for white enamel finish, and "S" for stainless steel. Receptacle colors match extrusion colors except for stainless steel which has black receptacles and isolated ground versions which have orange receptacles.

All 2000 Series Plugmold products include two (2) 2010B Blank End Fittings and one (1) 2001 Base Coupling unless otherwise indicated in the product description.

Plugmold 2000 Series Steel Multioutlet Systems Ordering Information

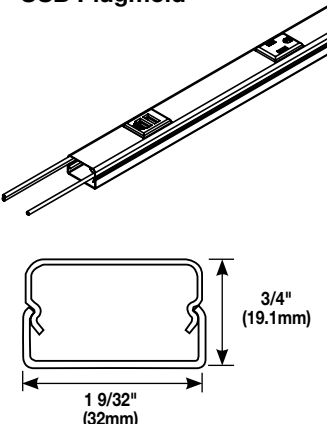
Product	Description/Specifications																																																																																																
USB Plugmold	Available in 3' (914mm), 5' (1.5m) and 6' (1.8m) lengths with 6" (152mm) receptacle spacing. 15A tamper-resistant receptacles. 3-wire, #12 THHN (1 hot, 1 neutral, and insulated ground conductor). .040" (1.0mm) steel housing. Packed 2 per carton. Each unit supplied with one (1) Coupling and two (2) Blank End Fittings. USB is 2.4 (shared between 2 ports) 5VDC.																																																																																																
	<table border="1"> <thead> <tr> <th>CATALOG NO.</th> <th>FINISH</th> <th>LENGTH Feet (mm)</th> <th>WIRING CONFIG</th> <th>CENTER DISTANCE Inches (mm)</th> <th>OUTLETS QUANTITY & TYPE</th> </tr> </thead> <tbody> <tr><td>WH20GB306TRUSB</td><td>White</td><td>3' (915mm)</td><td>GB</td><td>6" (152mm)</td><td>1 USB, 5 Single 15A</td></tr> <tr><td>BK20GB306TRUSB</td><td>Black</td><td>3' (915mm)</td><td>GB</td><td>6" (152mm)</td><td>1 USB, 5 Single 15A</td></tr> <tr><td>V20GB306TRUSB</td><td>Ivory</td><td>3' (915mm)</td><td>GB</td><td>6" (152mm)</td><td>1 USB, 5 Single 15A</td></tr> <tr><td>G20GB306TRUSB</td><td>Gray</td><td>3' (915mm)</td><td>GB</td><td>6" (152mm)</td><td>1 USB, 5 Single 15A</td></tr> <tr><td>S20GB306TRUSB</td><td>Stainless</td><td>3' (915mm)</td><td>GB</td><td>6" (152mm)</td><td>1 USB, 5 Single 15A</td></tr> <tr><td>WH20GB506TRUSB</td><td>White</td><td>5' (1.5m)</td><td>GB</td><td>6" (152mm)</td><td>1 USB, 9 Single 15A</td></tr> <tr><td>BK20GB506TRUSB</td><td>Black</td><td>5' (1.5m)</td><td>GB</td><td>6" (152mm)</td><td>1 USB, 9 Single 15A</td></tr> <tr><td>V20GB506TRUSB</td><td>Ivory</td><td>5' (1.5m)</td><td>GB</td><td>6" (152mm)</td><td>1 USB, 9 Single 15A</td></tr> <tr><td>G20GB506TRUSB</td><td>Gray</td><td>5' (1.5m)</td><td>GB</td><td>6" (152mm)</td><td>1 USB, 9 Single 15A</td></tr> <tr><td>S20GB506TRUSB</td><td>Stainless</td><td>5' (1.5m)</td><td>GB</td><td>6" (152mm)</td><td>1 USB, 9 Single 15A</td></tr> <tr><td>WH20GB606TRUSB</td><td>White</td><td>6' (1.8m)</td><td>GB</td><td>6" (152mm)</td><td>1 USB, 11 Single 15A</td></tr> <tr><td>BK20GB606TRUSB</td><td>Black</td><td>6' (1.8m)</td><td>GB</td><td>6" (152mm)</td><td>1 USB, 11 Single 15A</td></tr> <tr><td>V20GB606TRUSB</td><td>Ivory</td><td>6' (1.8m)</td><td>GB</td><td>6" (152mm)</td><td>1 USB, 11 Single 15A</td></tr> <tr><td>G20GB606TRUSB</td><td>Gray</td><td>6' (1.8m)</td><td>GB</td><td>6" (152mm)</td><td>1 USB, 11 Single 15A</td></tr> <tr><td>S20GB606TRUSB</td><td>Stainless</td><td>6' (1.8m)</td><td>GB</td><td>6" (152mm)</td><td>1 USB, 11 Single 15A</td></tr> </tbody> </table>	CATALOG NO.	FINISH	LENGTH Feet (mm)	WIRING CONFIG	CENTER DISTANCE Inches (mm)	OUTLETS QUANTITY & TYPE	WH20GB306TRUSB	White	3' (915mm)	GB	6" (152mm)	1 USB, 5 Single 15A	BK20GB306TRUSB	Black	3' (915mm)	GB	6" (152mm)	1 USB, 5 Single 15A	V20GB306TRUSB	Ivory	3' (915mm)	GB	6" (152mm)	1 USB, 5 Single 15A	G20GB306TRUSB	Gray	3' (915mm)	GB	6" (152mm)	1 USB, 5 Single 15A	S20GB306TRUSB	Stainless	3' (915mm)	GB	6" (152mm)	1 USB, 5 Single 15A	WH20GB506TRUSB	White	5' (1.5m)	GB	6" (152mm)	1 USB, 9 Single 15A	BK20GB506TRUSB	Black	5' (1.5m)	GB	6" (152mm)	1 USB, 9 Single 15A	V20GB506TRUSB	Ivory	5' (1.5m)	GB	6" (152mm)	1 USB, 9 Single 15A	G20GB506TRUSB	Gray	5' (1.5m)	GB	6" (152mm)	1 USB, 9 Single 15A	S20GB506TRUSB	Stainless	5' (1.5m)	GB	6" (152mm)	1 USB, 9 Single 15A	WH20GB606TRUSB	White	6' (1.8m)	GB	6" (152mm)	1 USB, 11 Single 15A	BK20GB606TRUSB	Black	6' (1.8m)	GB	6" (152mm)	1 USB, 11 Single 15A	V20GB606TRUSB	Ivory	6' (1.8m)	GB	6" (152mm)	1 USB, 11 Single 15A	G20GB606TRUSB	Gray	6' (1.8m)	GB	6" (152mm)	1 USB, 11 Single 15A	S20GB606TRUSB	Stainless	6' (1.8m)	GB	6" (152mm)	1 USB, 11 Single 15A
CATALOG NO.	FINISH	LENGTH Feet (mm)	WIRING CONFIG	CENTER DISTANCE Inches (mm)	OUTLETS QUANTITY & TYPE																																																																																												
WH20GB306TRUSB	White	3' (915mm)	GB	6" (152mm)	1 USB, 5 Single 15A																																																																																												
BK20GB306TRUSB	Black	3' (915mm)	GB	6" (152mm)	1 USB, 5 Single 15A																																																																																												
V20GB306TRUSB	Ivory	3' (915mm)	GB	6" (152mm)	1 USB, 5 Single 15A																																																																																												
G20GB306TRUSB	Gray	3' (915mm)	GB	6" (152mm)	1 USB, 5 Single 15A																																																																																												
S20GB306TRUSB	Stainless	3' (915mm)	GB	6" (152mm)	1 USB, 5 Single 15A																																																																																												
WH20GB506TRUSB	White	5' (1.5m)	GB	6" (152mm)	1 USB, 9 Single 15A																																																																																												
BK20GB506TRUSB	Black	5' (1.5m)	GB	6" (152mm)	1 USB, 9 Single 15A																																																																																												
V20GB506TRUSB	Ivory	5' (1.5m)	GB	6" (152mm)	1 USB, 9 Single 15A																																																																																												
G20GB506TRUSB	Gray	5' (1.5m)	GB	6" (152mm)	1 USB, 9 Single 15A																																																																																												
S20GB506TRUSB	Stainless	5' (1.5m)	GB	6" (152mm)	1 USB, 9 Single 15A																																																																																												
WH20GB606TRUSB	White	6' (1.8m)	GB	6" (152mm)	1 USB, 11 Single 15A																																																																																												
BK20GB606TRUSB	Black	6' (1.8m)	GB	6" (152mm)	1 USB, 11 Single 15A																																																																																												
V20GB606TRUSB	Ivory	6' (1.8m)	GB	6" (152mm)	1 USB, 11 Single 15A																																																																																												
G20GB606TRUSB	Gray	6' (1.8m)	GB	6" (152mm)	1 USB, 11 Single 15A																																																																																												
S20GB606TRUSB	Stainless	6' (1.8m)	GB	6" (152mm)	1 USB, 11 Single 15A																																																																																												

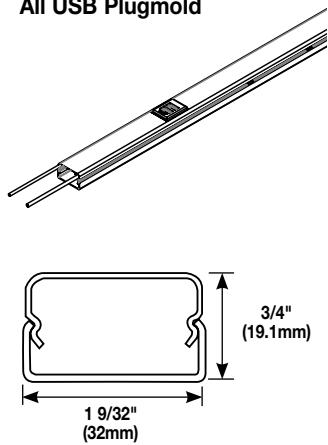
Product	Description/Specifications																																																																		
All USB Plugmold	Available in 3' (914mm), and 5' (1.5m) lengths with 12" spacing. USB is 2.4 Amps (shared between two ports) 5VDC. .040" (1.0mm) steel housing. Packed two per carton. Each unit supplied with one (1) Coupling and two (2) Blank End Fittings. Each USB module provides 2 ports with 2.4 Amps of shared charging. Please note the charging load on one module will not affect the charging performance of the other USB modules in the product.																																																																		
	<table border="1"> <thead> <tr> <th>CATALOG NO.</th> <th>FINISH</th> <th>LENGTH Feet (mm)</th> <th>WIRING CONFIG</th> <th>CENTER DISTANCE Inches (mm)</th> <th>OUTLETS QUANTITY & TYPE</th> </tr> </thead> <tbody> <tr><td>BK20USB312</td><td>Black</td><td>3' (915mm)</td><td>USB</td><td>12" (305mm)</td><td>3 USB Modules</td></tr> <tr><td>BK20USB512</td><td>Black</td><td>5' (1.5m)</td><td>USB</td><td>12" (305mm)</td><td>5 USB Modules</td></tr> <tr><td>G20USB312</td><td>Gray</td><td>3' (915mm)</td><td>USB</td><td>12" (305mm)</td><td>3 USB Modules</td></tr> <tr><td>G20USB512</td><td>Gray</td><td>5' (1.5m)</td><td>USB</td><td>12" (305mm)</td><td>5 USB Modules</td></tr> <tr><td>S20USB312</td><td>Stainless</td><td>3' (915mm)</td><td>USB</td><td>12" (305mm)</td><td>3 USB Modules</td></tr> <tr><td>S20USB512</td><td>Stainless</td><td>5' (1.5m)</td><td>USB</td><td>12" (305mm)</td><td>5 USB Modules</td></tr> <tr><td>V20USB312</td><td>Ivory</td><td>3' (915mm)</td><td>USB</td><td>12" (305mm)</td><td>3 USB Modules</td></tr> <tr><td>V20USB512</td><td>Ivory</td><td>5' (1.5m)</td><td>USB</td><td>12" (305mm)</td><td>5 USB Modules</td></tr> <tr><td>WH20USB312</td><td>White</td><td>3' (915mm)</td><td>USB</td><td>12" (305mm)</td><td>3 USB Modules</td></tr> <tr><td>WH20USB512</td><td>White</td><td>5' (1.5m)</td><td>USB</td><td>12" (305mm)</td><td>5 USB Modules</td></tr> </tbody> </table>	CATALOG NO.	FINISH	LENGTH Feet (mm)	WIRING CONFIG	CENTER DISTANCE Inches (mm)	OUTLETS QUANTITY & TYPE	BK20USB312	Black	3' (915mm)	USB	12" (305mm)	3 USB Modules	BK20USB512	Black	5' (1.5m)	USB	12" (305mm)	5 USB Modules	G20USB312	Gray	3' (915mm)	USB	12" (305mm)	3 USB Modules	G20USB512	Gray	5' (1.5m)	USB	12" (305mm)	5 USB Modules	S20USB312	Stainless	3' (915mm)	USB	12" (305mm)	3 USB Modules	S20USB512	Stainless	5' (1.5m)	USB	12" (305mm)	5 USB Modules	V20USB312	Ivory	3' (915mm)	USB	12" (305mm)	3 USB Modules	V20USB512	Ivory	5' (1.5m)	USB	12" (305mm)	5 USB Modules	WH20USB312	White	3' (915mm)	USB	12" (305mm)	3 USB Modules	WH20USB512	White	5' (1.5m)	USB	12" (305mm)	5 USB Modules
CATALOG NO.	FINISH	LENGTH Feet (mm)	WIRING CONFIG	CENTER DISTANCE Inches (mm)	OUTLETS QUANTITY & TYPE																																																														
BK20USB312	Black	3' (915mm)	USB	12" (305mm)	3 USB Modules																																																														
BK20USB512	Black	5' (1.5m)	USB	12" (305mm)	5 USB Modules																																																														
G20USB312	Gray	3' (915mm)	USB	12" (305mm)	3 USB Modules																																																														
G20USB512	Gray	5' (1.5m)	USB	12" (305mm)	5 USB Modules																																																														
S20USB312	Stainless	3' (915mm)	USB	12" (305mm)	3 USB Modules																																																														
S20USB512	Stainless	5' (1.5m)	USB	12" (305mm)	5 USB Modules																																																														
V20USB312	Ivory	3' (915mm)	USB	12" (305mm)	3 USB Modules																																																														
V20USB512	Ivory	5' (1.5m)	USB	12" (305mm)	5 USB Modules																																																														
WH20USB312	White	3' (915mm)	USB	12" (305mm)	3 USB Modules																																																														
WH20USB512	White	5' (1.5m)	USB	12" (305mm)	5 USB Modules																																																														

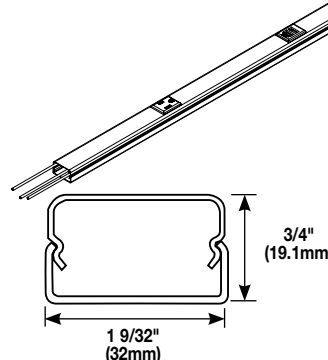
Product	Description/Specifications																																				
Alternating USB Plugmold	Available in 5' (1.5m) length with 9" spacing. 15A tamper-resistant receptacles. 3-wire, #12 THHN (1 hot, 1 neutral and insulated ground conductor). .040" (1.0 mm) steel housing. Packed two per carton. Each unit supplied with one (1) Coupling and two (2) Blank End Fittings. USB is 2.4 Amps (shared between two ports) 5VDC. Please note the charging load on one module will not affect the charging performance of the other USB modules in the product.																																				
	<table border="1"> <thead> <tr> <th>CATALOG NO.</th> <th>FINISH</th> <th>LENGTH Feet (mm)</th> <th>WIRING CONFIG</th> <th>CENTER DISTANCE Inches (mm)</th> <th>OUTLETS QUANTITY & TYPE</th> </tr> </thead> <tbody> <tr><td>BK20GB509TRUSBA</td><td>Black</td><td>5' (1.5m)</td><td>GB/USB</td><td>9" (229mm)</td><td>3 Outlets/3USB Modules</td></tr> <tr><td>G20GB509TRUSBA</td><td>Gray</td><td>5' (1.5m)</td><td>GB/USB</td><td>9" (229mm)</td><td>3 Outlets/3USB Modules</td></tr> <tr><td>S20GB509TRUSBA</td><td>Stainless</td><td>5' (1.5m)</td><td>GB/USB</td><td>9" (229mm)</td><td>3 Outlets/3USB Modules</td></tr> <tr><td>V20GB509TRUSBA</td><td>Ivory</td><td>5' (1.5m)</td><td>GB/USB</td><td>9" (229mm)</td><td>3 Outlets/3USB Modules</td></tr> <tr><td>WH20GB509TRUSBA</td><td>White</td><td>5' (1.5m)</td><td>GB/USB</td><td>9" (229mm)</td><td>3 Outlets/3USB Modules</td></tr> </tbody> </table>	CATALOG NO.	FINISH	LENGTH Feet (mm)	WIRING CONFIG	CENTER DISTANCE Inches (mm)	OUTLETS QUANTITY & TYPE	BK20GB509TRUSBA	Black	5' (1.5m)	GB/USB	9" (229mm)	3 Outlets/3USB Modules	G20GB509TRUSBA	Gray	5' (1.5m)	GB/USB	9" (229mm)	3 Outlets/3USB Modules	S20GB509TRUSBA	Stainless	5' (1.5m)	GB/USB	9" (229mm)	3 Outlets/3USB Modules	V20GB509TRUSBA	Ivory	5' (1.5m)	GB/USB	9" (229mm)	3 Outlets/3USB Modules	WH20GB509TRUSBA	White	5' (1.5m)	GB/USB	9" (229mm)	3 Outlets/3USB Modules
CATALOG NO.	FINISH	LENGTH Feet (mm)	WIRING CONFIG	CENTER DISTANCE Inches (mm)	OUTLETS QUANTITY & TYPE																																
BK20GB509TRUSBA	Black	5' (1.5m)	GB/USB	9" (229mm)	3 Outlets/3USB Modules																																
G20GB509TRUSBA	Gray	5' (1.5m)	GB/USB	9" (229mm)	3 Outlets/3USB Modules																																
S20GB509TRUSBA	Stainless	5' (1.5m)	GB/USB	9" (229mm)	3 Outlets/3USB Modules																																
V20GB509TRUSBA	Ivory	5' (1.5m)	GB/USB	9" (229mm)	3 Outlets/3USB Modules																																
WH20GB509TRUSBA	White	5' (1.5m)	GB/USB	9" (229mm)	3 Outlets/3USB Modules																																

NOTE: Color codes: "V" for Ivory ScuffCoat™ finish, "BK" for Black ScuffCoat™ finish, "G" for Gray enamel finish, "WH" for white enamel finish, and "S" for stainless steel. Receptacle colors match extrusion colors except for stainless steel which has black receptacles and isolated ground versions which have orange receptacles.

All 2000 Series Plugmold products include two (2) 2010B Blank End Fittings and one (1) 2001 Base Coupling unless otherwise indicated in the product description.

Plugmold 2000 Series Steel Multioutlet Systems Ordering Information

Cord-Ended Plugmold 2000 Series Steel Ordering Information

CAT NO.	UNIT LENGTH	OUTLETS QUANTITY	CORD SET LENGTH	TYPE	SWITCH	CIRCUIT BREAKER	FINISH
20-C2*	3' 4" (1m)	6 Single	6' (1.8m)	12/3 SJT	No	Yes	Steel – Gray, Ivory

* Use "V" prefix for Ivory ScuffCoat™ finish and "G" prefix for Gray enamel finish.

Plugmold 2000 Series Steel with Snapicoil Harness Ordering Information

CATALOG NO.	LENGTH		WIRING CONFIG	OUTLETS (15A 120V NEMA 5-15SR) CENTER DISTANCE		QUANTITY	HOLE CUT COVER LENGTH		HOUSING
	Feet	(meters)		Inches	(mm)		QUANTITY	Feet	
20GB12*	48'	(14.63)	GB	12"	(305mm)	48 Single	8	6' (1.8m)	Steel – Ivory, Gray
20GB18*	48'	(14.63)	GB	18"	(457mm)	32 Single	8	6' (1.8m)	Steel – Ivory, Gray
V20GB30	50'	(15.25)	GB	30"	(760mm)	20 Single	10	5' (1.5m)	Steel – Ivory
20GBA12*	48'	(14.63)	GBA	12"	(305mm)	48 Single	8	6' (1.8m)	Steel – Ivory, Gray

* Available in Ivory ScuffCoat™ finish ("V") and Gray enamel finish ("G").

2000 Series Steel Raceway Fittings Ordering Information

2000*

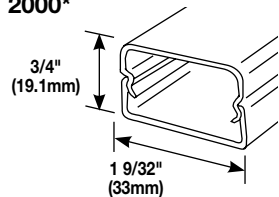

Base & Cover – Base – 2000B
.040" (1.0mm) steel. Cover – 2000C
.025" (.6mm) steel.

Country of Origin: USA

Cross-Sectional Area:
0.80in² (516mm²)

ITEM	CAT NO.	LENGTH	MATERIAL
Base	2000B-5*	5' (1.5m)	.040 Steel
Cover	2000C*	5' (1.5m)	.025 Steel
Base & Cover	2000BC*	5' (1.5m)	.025 Steel

V2003

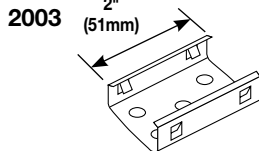

Supporting Clip – For temporary support, while positioning lengths of raceway base. Use with V/G 2000 Series. V2003 has ivory finish, 2003 has plated finish.

Country of Origin: USA

W30
W30/W30G

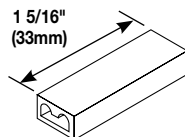

Pressure-Type Wire Connectors–

W30 – For common connection of two, three, or four No. 12 or No. 14 solid copper conductors (White).
W30/W30G – For connection of equipment grounding of 2, 3, or 4 solid conductors No. 14 or No. 12 AWG (Green). 300V maximum; 20A 105° C maximum.

Country of Origin: USA

NOTE: Not for use with aluminum conductors.

2000WC

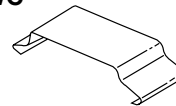

Wire Clip – Holds conductors in place in raceway.

Country of Origin: USA

2001

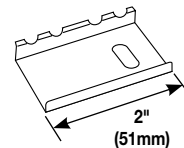

Coupling – For joining lengths of 2000 Series Raceway Base.

Country of Origin: USA

BK2006*
G2006*
V2006*
WH2006*
S2006*

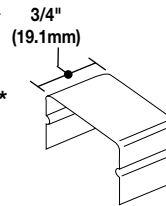

Cover Clip – For covering joint where lengths of cover or base adjoin. Use with 2000 Series.

Country of Origin: USA

2009

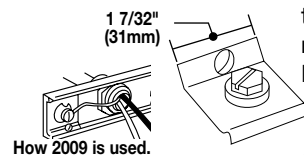

Ground Clamp – For connection of equipment grounding conductor to provide additional ground to raceway. Use with 2000 Series Raceway.

Country of Origin: USA

* "V" prefix indicates Ivory ScuffCoat™ finish, "BK" for Black ScuffCoat™ finish, "G" prefix for Gray enamel finish, "WH" for white enamel finish, and "S" for stainless steel.

2000 Series Steel Raceway Fittings Ordering Information

BK2010A2*
G2010A2*
V2010A2*
WH2010A2*
S2010A2*

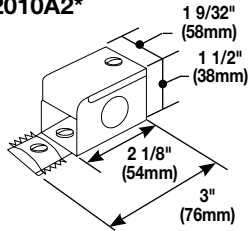

Entrance End – For connecting 2000 Series Raceway with 1/2" conduit and armored cable connectors. 1/2" trade size KOs on end, each side and bottom. Includes ground screw. Use with 2000 Series Raceway.

Country of Origin: USA

BK2010A3*
G2010A3*
V2010A3*
WH2010A3*

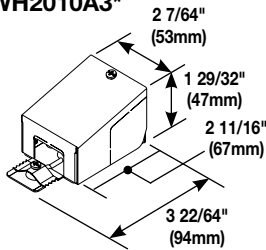

Entrance End – Offers larger capacity than V2010A2. 1/2" trade size KOs on end, each side and bottom. 3/4" trade size KOs on bottom and rear. Includes ground screw. Use with 2000 Series.

Country of Origin: USA

BK2010B*
G2010B*
V2010B*
WH2010B*
S2010B*

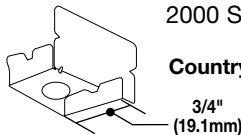

Blank End Fitting – For closing the open end of raceway. Use with 2000 Series Raceway.

Country of Origin: USA

BK2011*
G2011*
V2011*
WH2011*
S2011*

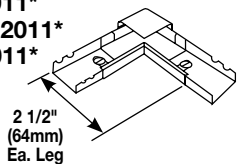

90° Flat Elbow – For right angle turns on same surface. Cover stop permits neat butting of 2000C Cover. Two couplings furnished.

Country of Origin: USA

BK2015*
G2015*
V2015*
WH2015*
S2011*

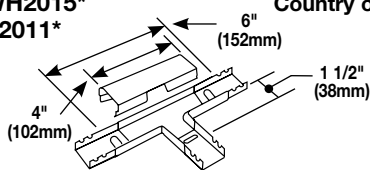

Tee – For branches at right angles. Couplings furnished.

Country of Origin: USA

20017TC

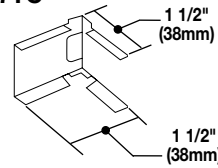

Internal Corner Coupling – Furnished with one fiber bushing.

Country of Origin: USA

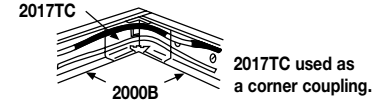

BK2018C*
G2018C*
V2018C*
WH2018C*
S2018C*

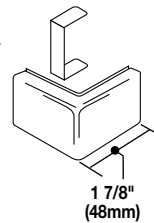

External Elbow – To continue raceway runs around outside corner. Fills the gap when external corner is made by notching and bending the 2000B Base.

Country of Origin: USA



BK2048*
G2048*
V2048*
WH2048*
S2048*

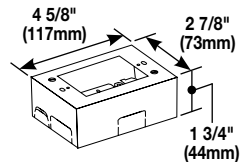

Single Gang Device Box – Cover has twistouts for 2000, 500, and 700 Series Raceway. Base has 1/2" trade size KO and rectangular KO for extension to wall box. Base has #10 threaded hole for ground connection.

Country of Origin: USA

V2048-2
G2048-2

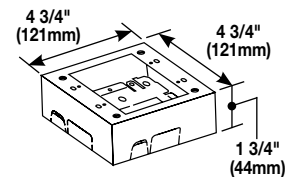

Two-Gang Device Box – Cover has twistouts for 2000, 500, and 700 Series Raceway. Base has 1/2" trade size KO and rectangular KO for extension to wall box. Base has #10 threaded hole for ground connection.

Country of Origin: USA

BK2051H*
G2051H*
V2051H*
WH2051H*
S2051H*

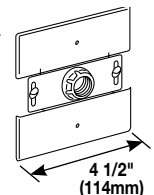

Flush Plate Adapter – For feeding 2000 Series Raceway from an existing wall outlet. Equipped with 1/2" (12.7mm) threaded stud, toothed lockwasher for grounding, and conduit bushing.

Country of Origin: USA

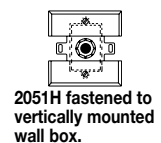
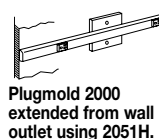

* "V" prefix indicates Ivory ScuffCoat™ finish, "BK" for Black ScuffCoat™ finish, "G" prefix for Gray enamel finish, "WH" for white enamel finish, and "S" for stainless steel.

2000 Series Steel Raceway Fittings Ordering Information

V2089

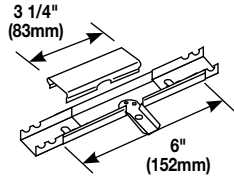

Side Reducing Connector – For connecting 2000 Series Raceway with 500 Series Raceway through side of 2000 Series Raceway.

Country of Origin: USA

620BCK

Replacement Blade Kit – Replacement blades and die set for 620 Cutter.

Country of Origin: USA

V2089E

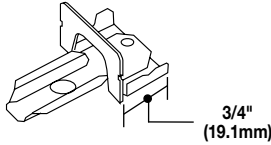

End Reducing Connector – For connecting 2000 Series Raceway with 500 Series Raceway through end of 2000 Series Raceway.

Country of Origin: USA

620

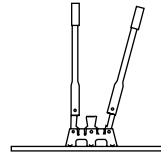

2000 Raceway Base & Cover Cutter – Portable cutter for 2000 Series Raceway Cover and Base. Tooled steel construction for clean and easy square cuts every time. Total manual operation.

Country of Origin: USA

Plugmold 2400 Series Steel Multioutlet Systems

2400 Series Plugmold Wire Fill Capacities for Power				
CABLE TYPE	WIRE SIZE THHN/THWN	O.D.		NO. OF CONDUCTORS (40% FILL) 2400
		Inches	(mm)	
POWER WIRING WITHOUT DEVICES	10 AWG	0.166	(4.2)	26
	12 AWG	0.130	(3.3)	41
	14 AWG	0.111	(2.8)	57
POWER WIRING WITH DEVICES (Plugmold Series)	8 AWG	0.218	(5.5)	2
	10 AWG	0.153	(3.9)	6
	12 AWG	0.122	(3.1)	10
	14 AWG	0.105	(2.7)	-

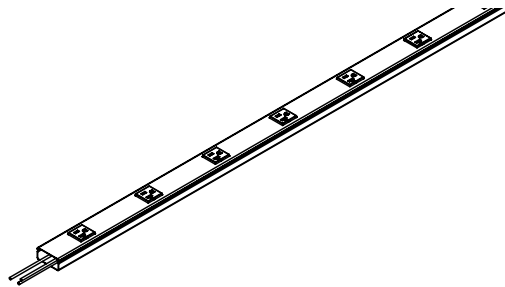
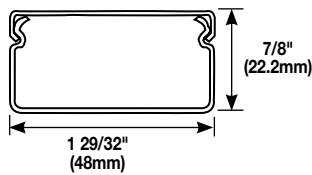

Plugmold 2400 Series Steel Part Numbering System

2400 Series Steel Plugmold Series w/Simplex Receptacle – Example: 24GBA512



V	24	G B A	5	12
COLOR:	RACEWAY:	WIRING CONFIGURATION:	LENGTH:	CENTER DISTANCE:
Ivory = V	2400 = 24	GB = GB GBA = GBA	36" (915mm) = 3 60" (1.5m) = 5 72" (1.8m) = 6	6" (152mm) = 6 12" (305mm) = 12 18" (457mm) = 18

2400 Series Steel Plugmold Series w/Duplex Receptacle – Example: 24SGBX3618I

24S	36	18	G B X	99IV
RACEWAY:	LENGTH:	CENTER DISTANCE:	WIRING CONFIGURATION:	COLOR:
2400 = 24S	36" (915mm) = 36 60" (1.5m) = 60 72" (1.8m) = 72	12" (305mm) = 12 18" (457mm) = 18 24" (610mm) = 24	GBX = GBX GBA = GBA IGX = IGX	Ivory = 99IV

NOTE: Not all combinations of color, wiring configurations, length, and center distance are available as standard products. For additional information, contact Wiremold Technical Support at 1-800-621-0049.

NOTE: Color codes: "V" for Ivory ScuffCoat™ finish. Receptacle colors match extrusion colors except for isolated ground versions which have orange receptacles.

* All 2400 Series Plugmold products include two (2) 2410B Blank End Fittings and one (1) 2401 Base Coupling unless otherwise indicated in the product description.

Plugmold 2400 Series Steel Multioutlet Systems Ordering Information

Product	Description/Specifications
---------	----------------------------

Plugmold 2400 Series

Available in 3' (914mm), 5' (1.5m) and 6' (1.8m) lengths with 6" (152mm), 12" (305mm), 18" (457mm) and 24" (608mm) receptacle spacing. 15A and 20A receptacles. 3-wire, #12 THHN (1 hot, 1 neutral, and insulated ground conductor). .040" (1.0mm) steel housing. Packed 2 per carton. Each unit supplied with one (1) Coupling and two (2) Blank End Fittings.

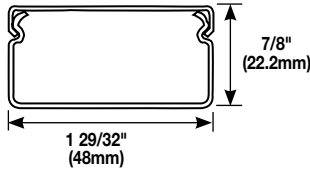
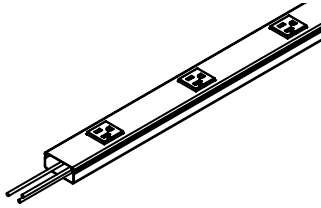

CATALOG NO.	FINISH	LENGTH Feet (mm)	WIRING CONFIG	CENTER DISTANCE Inches (mm)	OUTLETS QUANTITY & TYPE
V24GB306	Ivory	3' (915mm)	GB	6" (152mm)	6 Single 20A
24S3612GBX99IV	Ivory	3' (915mm)	GB	12" (305mm)	3 Duplex 20A
24S3612GBA99IV	Ivory	3' (915mm)	GBA	12" (305mm)	3 Duplex 20A
V24GB506	Ivory	5' (1.5m)	GB	6" (152mm)	10 Single 20A
V24GB512	Ivory	5' (1.5m)	GB	12" (305mm)	5 Single 20A
V24GBA512	Ivory	5' (1.5m)	GBA	12" (305mm)	5 Single 20A
24S6012GBX99IV	Ivory	5' (1.5m)	GB	12" (305mm)	5 Duplex 20A
24S6012GBA99IV	Ivory	5' (1.5m)	GBA	12" (305mm)	5 Duplex 20A
24S6012IGX99IV	Ivory	5' (1.5m)	IG	12" (305mm)	5 Duplex 20A
V24GB606	Ivory	6' (1.8m)	GB	6" (152mm)	12 Single 20A
V24GB612	Ivory	6' (1.8m)	GB	12" (305mm)	6 Single 20A
V24GBA612	Ivory	6' (1.8m)	GBA	12" (305mm)	6 Single 20A
V24GB618	Ivory	6' (1.8m)	GB	18" (457mm)	4 Single 20A
V24GBA618	Ivory	6' (1.8m)	GBA	18" (457mm)	4 Single 20A
24S7212GBX99IV	Ivory	6' (1.8m)	GB	12" (305mm)	6 Duplex 20A
24S7224GBA99IV	Ivory	6' (1.8m)	GBA	24" (608mm)	3 Duplex 20A
24S7218GBX99IV	Ivory	6' (1.8m)	GB	18" (457mm)	4 Duplex 20A
24S7224GBX99IV	Ivory	6' (1.8m)	GB	24" (608mm)	3 Duplex 20A
24S7218IGX99IV	Ivory	6' (1.8m)	IG	18" (457mm)	4 Duplex 20A
24S7212IGX99IV	Ivory	6' (1.8m)	IG	12" (305mm)	6 Duplex 20A
24S7224IGX99IV	Ivory	6' (1.8m)	IG	24" (608mm)	3 Duplex 20A
24S7212GBA99IV	Ivory	6' (1.8m)	GBA	12" (305mm)	6 Duplex 20A
24S7218GBA99IV	Ivory	6' (1.8m)	GBA	18" (457mm)	4 Duplex 20A

NOTE: Color codes: "V" for Ivory ScuffCoat™ finish. Receptacle colors match extrusion colors except for isolated ground versions which have orange receptacles.

All 2400 Series Plugmold products include two (2) 2410B Blank End Fittings and one (1) 2401 Base Coupling unless otherwise indicated in the product description.

2400 Series Plugmold Wiring Configurations

			With Snapicoil	
<p>GB Series: 3-wire, #12 THHN (1 hot, 1 neutral and 1 ground), 1 circuit; has insulated grounding conductor.</p>	<p>GBA Series: 4-wire, #12 THHN (2 hot, 1 neutral and 1 ground), 2 circuit; outlets wired alternately; has insulated grounding conductor.</p>	<p>IG Series: 3-wire, #12 THHN (1 hot, 1 neutral and 1 ground), 1 circuit; has insulated-isolated grounding conductor. Orange receptacles.</p>	<p>GB Series: 3-wire, #12 THHN (1 hot, 1 neutral and 1 ground), 1 circuit; has insulated grounding conductor.</p>	<p>GBA Series: 4-wire, #12 THHN (2 hot, 1 neutral and 1 ground), 2 circuit; outlets wired alternately; has insulated grounding conductor.</p>

NOTE: SNAPICOIL REELS on custom order. Snapicoil harness is available on reels if lengths greater than 50' are needed, or if multiple lengths are required for production-type jobs. The maximum length per reel is 240' for Snapicoil with outlets 12" and 18" on centers; 500' with outlets 30" on center. Packaging includes the necessary number of lengths of base, holecut cover, wire clips, and couplings for complete installation. Price and delivery information should be obtained prior to specifying or ordering. To specify or order, add "R" to the Snapicoil number. Ex: V24GB12R. Other outlet spacings available on custom order.

Receptacles are made from high impact thermoplastic. Snapicoil packaging includes the necessary lengths of 2400B Base, 2400C Hole Cut Cover, 2400WC Wire Clips, and 2401 Couplings for complete installation.

2400 Series Steel Raceway Fittings Ordering Information

V2400

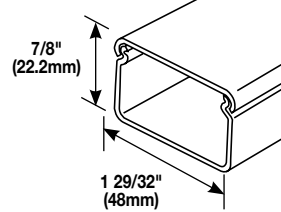

Base and Cover –
Base – V2400B .040" (1.0mm) steel.
Cover – V2400C .040" (1.0mm) steel.
Also available in custom colors.

Country of Origin: USA

Cross-Sectional Area:
1.39in² (897mm²)

ITEM	CAT. NO.	LENGTH	MATERIAL
Base	V2400B	5' (1.5m)	.040 Steel
Base	V2400B-10	10' (3.0m)	.040 Steel
Cover	V2400C	5' (1.5m)	.025 Steel
Base & Cover	V2400BC	5' (1.5m)	.025 Steel

V2410C

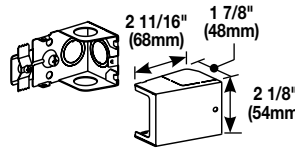

Entrance End Fitting – Has 1/2" and 3/4" trade size KOs on end and bottom. Additional 1/2" trade size KO on sides.

Country of Origin: USA

V2411M

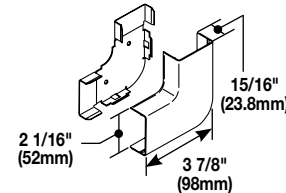

90° Flat Elbow – For right angle turns on the same surface (nonmetallic cover).

Country of Origin: USA

2401

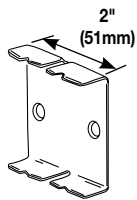

Coupling – For joining lengths of raceway. Use with V2400 Series.

Country of Origin: USA

V2417M

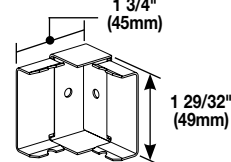

Internal Elbow – For making internal 90° corners. All steel construction.

Country of Origin: USA

2400WC

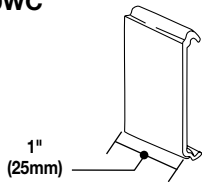

Wire Clip – Holds conductors in place in raceway.

Country of Origin: USA

V2418M

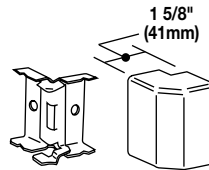

External Elbow – For covering outside corners (nonmetallic cover).

Country of Origin: USA

V2406

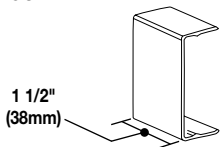

Cover Clip – For covering joint where lengths of cover or base adjoin. Use with V2400 Series (nonmetallic).

Country of Origin: USA

V2451H

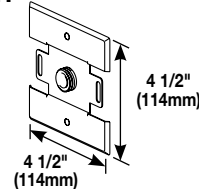

Back Feed Fitting – For feeding 2400 Series Raceway from an existing outlet box. Equipped with 1/2" trade size male bushing and locknut washer for grounding.

Country of Origin: USA

2409

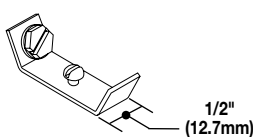

Ground Clamp – No. 10 ground screw provided. Use with V2400 Series Raceway.

Country of Origin: USA

V2448 V2448-2

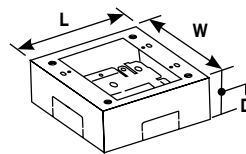

Device Box – Base has 1/2" trade size KO and rectangular KO for extension to wall box. Has #10 threaded hole for ground connection. Cover has twistouts for 500/700 Series Raceway on each end and twistouts for 2400 Series Raceway on each side.

Country of Origin: USA

V2410A

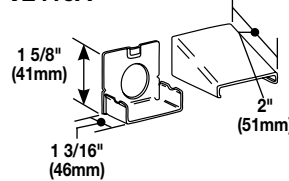

Entrance End – For connecting V2400 with 1/2" trade size conduit and armored cable. Use with V2400 Series Raceway.

Country of Origin: USA

CAT. NO.	L	W	D	GANG #
V2448	4 5/8" (117mm)	2 7/8" (73mm)	1 3/4" (44mm)	1
V2448-2	4 3/4" (121mm)	4 3/4" (121mm)	1 3/4" (44mm)	2

V2410B

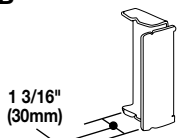

Blank End – For closing open end of V2400 Series Raceway.

Country of Origin: USA

2400 Series Steel Raceway Fittings Ordering Information

**V2444
V2444-2**

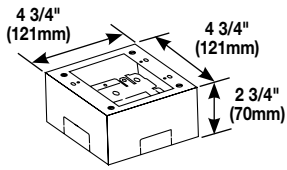

Extra Deep Device Box – Base has rectangular knockout to enable extension from existing single-gang flush wall box and 1/2" and 1" concentric KOs. Cover has twistouts for 500/700 Series Raceway on each end and twistouts for 2400 Series Raceway on each side.

Country of Origin: USA

CAT. NO.	L	W	D	GANG #
V2444	4 5/8" (117mm)	2 7/8" (73mm)	1 3/4" (44mm)	1
V2444-2	4 3/4" (121mm)	4 3/4" (121mm)	1 3/4" (44mm)	2

V2489



Side Reducing Connector – For connecting V2400 Series Raceway with V500 Series Raceway.

Country of Origin: USA

624



2400 and 2400BD Raceway & Cover Cutter – Portable cutter for 2400B and 2400BD Raceway and Cover. Tooled steel construction for clean and easy square cuts. Total manual operation.

Country of Origin: USA

624BCK

Replacement Blade Kit – Replacement blades and die set for 624 Cutter.

Country of Origin: USA

V2427GA

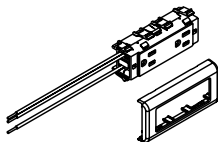

Duplex Receptacle – 3-wire, 15A, 125V, NEMA 5-15R. Provided with 10 1/2" (267mm) pigtails and inline splice connectors.

Country of Origin: USA

V2427GT

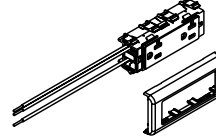

Duplex Receptacle – 3-wire, 20A, 125V, NEMA 5-20R. Provided with 10 1/2" (267mm) pigtails and inline splice connectors.

Country of Origin: USA

2686FO

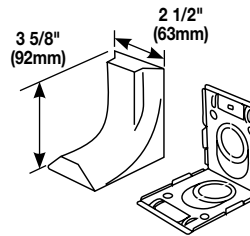

FiberReady Transition Feed Fitting – Eliminates offsetting V2400 in connecting with surface panel boxes. Has 3/4" and 1" concentric trade size KOs with 1" trade size KO elongated so adjustment from surface to center of bushing is 1" (25mm) minimum to 1 5/8" (41mm) maximum. Has twistouts for transition to Pancake 1500 and 2600 Series Raceway.

Country of Origin: USA

IG2427GA



Isolated Ground Duplex Receptacle – 3-wire, 15A, 125V NEMA 5-15R. Provided with 10 1/2" (267mm) pigtails and inline splice connectors.

Country of Origin: USA

IG2427GT

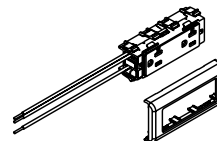

Isolated Ground Duplex Receptacle – 3-wire, 20A, 125V NEMA 5-20R. Provided with 10 1/2" (267mm) pigtails and inline splice connectors.

Country of Origin: USA

V2426

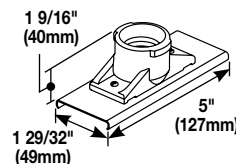

Lamp Holder – Medium base lamp holder 660W, 250V. Black, general purpose phenolic.

Country of Origin: USA

Aluminum Plugmold® Multioutlet Systems

Aluminum Plugmold® Multioutlet Systems offer an attractive choice for hospital and commercial labs, as well as for residential applications. The durable finish offers both aesthetics and corrosion resistance. Aluminum Plugmold Series is available in single and alternating circuits, with standard or isolated ground tamper-resistant receptacles. It can also be customized to meet virtually any job requirement.

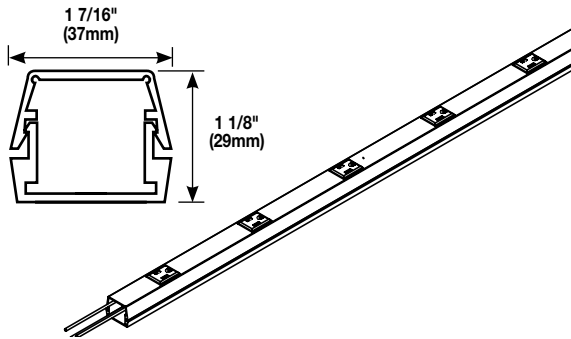

The durable corrosion-resistant finish of Aluminum Plugmold Series makes it an ideal solution for use in laboratories.

Plugmold AL2000 Series Wire Fill Capacities for Power				
CABLE TYPE	WIRE SIZE THHN/THWN	O.D.		NO. OF CONDUCTORS (40% FILL) AL2000
		Inches	(mm)	
POWER WIRING WITHOUT DEVICES	8 AWG	0.216	(5.5)	12
	10 AWG	0.166	(4.2)	24
	12 AWG	0.130	(3.3)	38
	14 AWG	0.111	(2.8)	51
POWER WIRING WITH DEVICES (Plugmold Series)	8 AWG	0.218	(5.5)	–
	10 AWG	0.153	(3.9)	3
	12 AWG	0.122	(3.1)	6
	14 AWG	0.105	(2.7)	8

Plugmold AL2400 Series Wire Fill Capacities for Power				
CABLE TYPE	WIRE SIZE THHN/THWN	O.D.		NO. OF CONDUCTORS (40% FILL) AL2000
		Inches	(mm)	
POWER WIRING WITHOUT DEVICES	6 AWG	0.254	(6.5)	13
	8 AWG	0.216	(5.5)	18
	10 AWG	0.164	(4.2)	37
	12 AWG	0.130	(3.3)	58
	14 AWG	0.111	(2.8)	78
POWER WIRING WITH DEVICES (Plugmold Series)	6 AWG	0.254	(6.5)	3
	8 AWG	0.216	(5.5)	4
	10 AWG	0.164	(4.2)	8
	12 AWG	0.130	(3.3)	12
	14 AWG	0.111	(2.8)	16

Plugmold AL2000 Series Steel Multioutlet Systems Ordering Information

Plugmold AL2000 Series Aluminum Part Numbering System

AL2000 Series Aluminum Plugmold Series – Example: AL20GB306TR

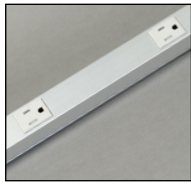

AL	20	GB	3	06	TR
COLOR:	RACEWAY:	WIRING CONFIGURATION:	LENGTH:	CENTER DISTANCE:	TYPE:
Aluminum = AL 2000 = 20	GB = GB GBA = GBA IG = IG*	24" (608mm) = 2 36" (915mm) = 3 60" (1.5m) = 5 72" (1.8m) = 6	6" (152mm) = 6 9" (229mm) = 9 12" (305mm) = 12 18" (457mm) = 18	Tamper-Resistant = TR	

NOTE: Not all combinations of color, wiring configurations, length, and center distance are available as standard products. For additional information on custom options, contact Wiremold Technical Support at 1-800-621-0049.

NOTE: AL2000 Series Aluminum Plugmold products are available in an anodized finish with gray receptacles. IG receptacles are orange.

* All AL2000 Series Plugmold products include two (2) AL2010B Blank End Fittings and one (1) AL2001 Base Coupling unless otherwise indicated in the product description.

Plugmold AL2000 Series Aluminum Multioutlet Systems Ordering Information

Product	Description/Specifications
---------	----------------------------

Plugmold AL2000 Series

Available in 3' (914mm), 5' (1.5m) and 6' (1.8m) lengths with 6" (152mm), 12" (305mm) and 18" (457mm) receptacle spacing. 15A tamper-resistant receptacles. 3-wire, #12 THHN (1 hot, 1 neutral, and insulated ground conductor). Packed 2 per carton. Each unit supplied with one (1) Coupling and two (2) Blank End Fittings.

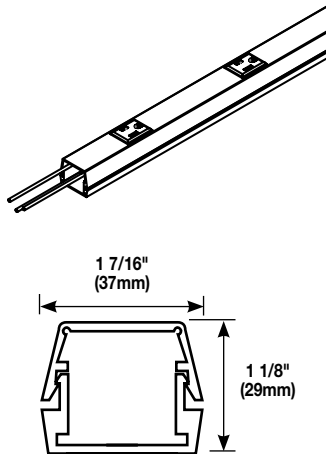

CATALOG NO.	FINISH	LENGTH Feet (mm)	WIRING CONFIG	CENTER DISTANCE Inches (mm)	OUTLETS QUANTITY & TYPE
AL20GB306TR	Aluminum	3' (915mm)	GB	6" (152mm)	6 Single 15A
AL20GB506TR	Aluminum	5' (1.5m)	GB	6" (152mm)	10 Single 15A
AL20GB512TR	Aluminum	5' (1.5m)	GB	12" (305mm)	5 Single 15A
AL20GB606TR	Aluminum	6' (1.8m)	GB	6" (152mm)	12 Single 15A
AL20GB612TR	Aluminum	6' (1.8m)	GB	12" (305mm)	6 Single 15A
AL20GB618TR	Aluminum	6' (1.8m)	GB	18" (457mm)	4 Single 15A
AL20GBA606TR	Aluminum	6' (1.8m)	GBA	6" (152mm)	12 Single 15A
AL20GBA612TR	Aluminum	6' (1.8m)	GBA	12" (305mm)	6 Single 15A
AL20GBA618TR	Aluminum	6' (1.8m)	GBA	18" (457mm)	4 Single 15A

Aluminum GFCI Plugmold

GFCI Module provides downstream protection for all outlets and connections. Available in 3' (914mm), 5' (1.5m) and 6' (1.8m) lengths with 6" (152mm) receptacle spacing. 15A tamper-resistant receptacles. 3-wire, #12 THHN (1 hot, 1 neutral, and insulated ground conductor). Packed 2 per carton. Each unit supplied with one (1) Coupling and two (2) Blank End Fittings. GFCI Class A 20A 125V 60Hz.

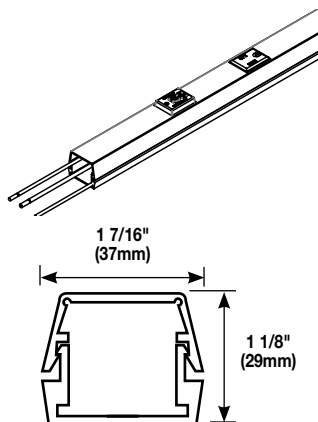

CATALOG NO.	FINISH	LENGTH Feet (mm)	WIRING CONFIG	CENTER DISTANCE Inches (mm)	OUTLETS QUANTITY & TYPE
AL20GB306TRGFI6	Aluminum	3' (915mm)	GB	6" (152mm)	1 GFCI, 5 Single 15A
AL20GB506TRGFI6	Aluminum	5' (1.5m)	GB	6" (152mm)	1 GFCI, 9 Single 15A

NOTE: GFCI module does not contain an outlet.

Plugmold AL2000 Series Steel Multioutlet Systems Ordering Information

Product	Description/Specifications
---------	----------------------------

Aluminum All USB Plugmold

Available in 3' (914mm), and 5' (1.5m) lengths with 12" spacing. USB is 2.4 Amps (shared between two ports) 5VDC. Packed two per carton. Each unit supplied with one (1) Coupling and two (2) Blank End Fittings.

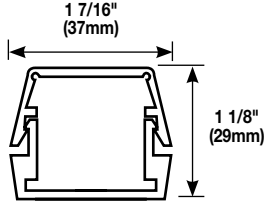
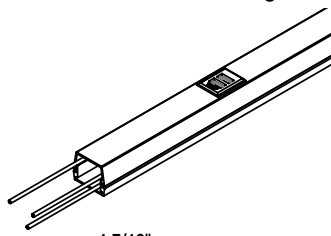

CATALOG NO.	FINISH	LENGTH Feet (mm)	WIRING CONFIG	CENTER DISTANCE Inches (mm)	OUTLETS QUANTITY & TYPE
AL20USB312	Aluminum	3' (915mm)	USB	12" (305mm)	3 USB Modules
AL20USB512	Aluminum	5' (1.5m)	USB	12" (305mm)	5 USB Modules

Aluminum Alternating USB Plugmold

Available in 5' (1.5m) length with 9" spacing. 15A tamper-resistant receptacles. 3-wire, #12 THHN (1 hot, 1 neutral and insulated ground conductor). Packed two per carton. Each unit supplied with one (1) Coupling and two (2) Blank End Fittings. USB is 2.4 Amps (shared between two ports) 5VDC. Please note the charging load on one module will not affect the charging performance of the other USB modules in the product.

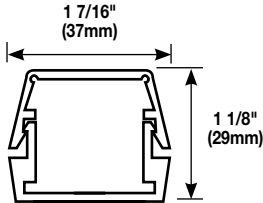
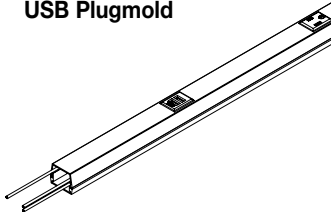

CATALOG NO.	FINISH	LENGTH Feet (mm)	WIRING CONFIG	CENTER DISTANCE Inches (mm)	OUTLETS QUANTITY & TYPE
AL20GB509TRUSBA	Aluminum	5' (1.5m)	GB/USB	9" (229mm)	3 Outlets/3USB Modules

NOTE: AL2000 Series Aluminum Plugmold products are available in an anodized finish with gray receptacles. IG receptacles are orange. All AL2000 Series Plugmold products include two (2) AL2010B Blank End Fittings and one (1) AL2001 Base Coupling unless otherwise indicated in the product description.

AL2000/AL2400 Series Aluminum Raceway Fittings Ordering Information

AL2000
AL2400

Base and Cover – 6063-T5 extruded aluminum, satin anodized finish, .060" (1.5mm) nominal thickness.

Country of Origin: USA

Cross-Sectional Area:
1in² (645mm²)

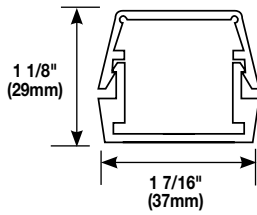

ITEM	CAT. NO.	LENGTH	MATERIAL
Base	AL2000B-5	5' (1.5m)	.060 Aluminum
Cover	AL2000C-5	5' (1.5m)	.060 Aluminum
Base	AL2000B-10	10' (3.m)	.060 Aluminum
Base	AL2400B-5	5' (1.5m)	.060 Aluminum
Cover	AL2400C	5' (1.5m)	.060 Aluminum
Base	AL2400B-10	10' (3.m)	.060 Aluminum

AL2003

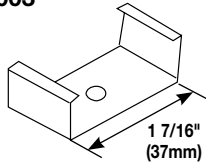

Supporting Clip – Mount to surface with No. 8 flathead screws. Use with AL2000 Series.

Country of Origin: USA

AL2000WC
AL2400WC

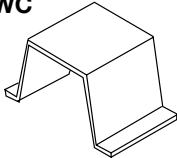

Wire Clip – Holds conductors in place in raceway (nonmetallic).

Country of Origin: USA

W30/W30G

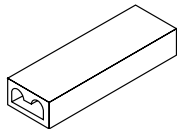

Pressure-Type Wire Connectors – W30 – For common connection of two, three, or four No. 12 or No.14 solid copper conductors (White).

W30G – For connection of equipment grounding of 2, 3, or 4 solid conductors No. 14 or No. 12 AWG (Green). 300V maximum; 20A 105° C maximum.

Country of Origin: USA

NOTE: Not for use with aluminum conductors.

AL2001
AL2401

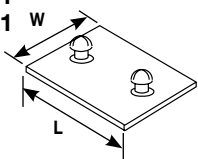

Coupling – For joining lengths of raceway. Use with AL2000 Series.

Country of Origin: USA

CAT NO.	L	W
AL2001	1 5/8" (41mm)	1 1/2" (38mm)
AL2401	3" (76mm)	1 3/4" (44mm)

AL2006
AL2406

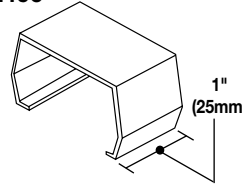

Cover Clip – For covering joint where lengths of cover or base adjoin. Use with AL2000 Series.

Country of Origin: USA

AL2009

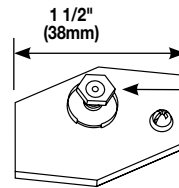

Ground Clamp – Use with AL2000 Series.

Country of Origin: USA

#8 Ground Stud
W/Cup Washer

AL2010A

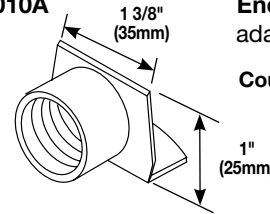

End Fitting – With 1/2" hub adapter. Use with AL2000 Series.

Country of Origin: USA

AL2010B

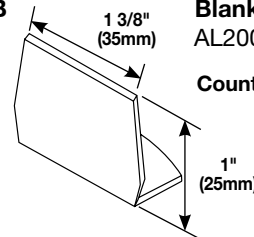

Blank End – Use with AL2000 Series.

Country of Origin: USA

AL2051H
AL2451H

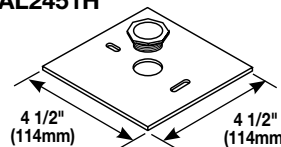

Box Adapter – For feeding raceway from an existing wall outlet.

Country of Origin: USA

AL2011
AL2411

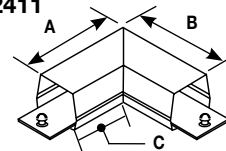

90° Flat Elbow – For right angle turn on same surface. Comes with two couplings.

Country of Origin: Mexico

CAT NO.	A	B	C
AL2011	3" (76mm)	3" (76mm)	1 9/16" (40mm)
AL2411	4" (102mm)	4" (102mm)	2" (51mm)

AL2000/AL2400 Series Aluminum Raceway Fittings Ordering Information

AL2015
AL2415

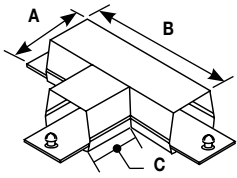

Tee – For branch connection of two runs of AL2000 Raceway. Three couplings furnished.

Country of Origin: Mexico

CAT NO.	A	B	C
AL2015	1 7/16" (37mm)	4" (102mm)	1 9/16" (40mm)
AL2415	4" (102mm)	6" (152mm)	2" (51mm)

AL2409

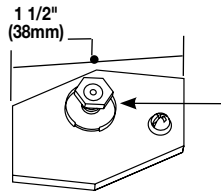

Ground Clamp – Use with AL2400 Series.

Country of Origin: USA

#8 Ground Stud
W/Cup Washer

AL2010B

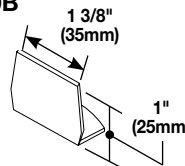

Blank End – Use with AL2000 Series.

Country of Origin: USA

AL2017
AL2417

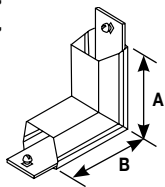

Internal Elbow – For bending around internal corners. Two couplings furnished.

Country of Origin: Mexico

CAT NO.	A
AL2017	3" (76mm)
AL2417	4" (102mm)

AL2410B2

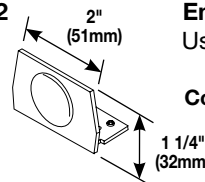

End Fitting – With 1/2" plastic KO. Use with AL2400 Series.

Country of Origin: USA

AL2018
AL2418

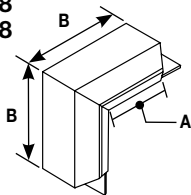

External Elbow – For making 90° external corners. Two couplings furnished.

Country of Origin: Mexico

CAT NO.	A	B
AL2018	1 7/8" (48mm)	3" (76mm)
AL2418	3" (76mm)	5" (127mm)

AL2044
AL2044-2

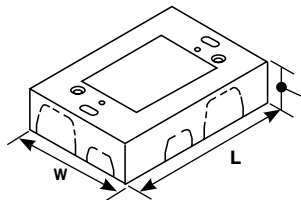

Deep Device Box – For receptacles and deep devices such as those of signal and alarm systems. Base has open back plate for mounting to existing wall box and solid back plate insert with 1/2" (AL2000 Raceway) and 3/4" (AL2000 Raceway) KO to close opening.

Country of Origin: USA

CAT. NO.	L	W	D	GANG #
AL2044	4 5/8" (117mm)	3 1/16" (73mm)	2 1/4" (57mm)	1
AL2044-2	4 5/8" (117mm)	4 27/32" (121mm)	2 1/2" (64mm)	2

AL2038

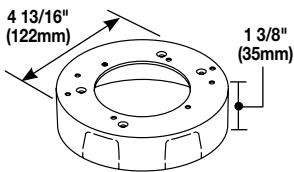

Round Fixture Box (Solid Base) – Designed for use in hanging fixtures. Cover takes any device with mounting screw centers of 2 3/4", 3 1/2", and 4 1/16" (70mm, 89mm, and 103mm). Base has concentric 1/2" and 3/4" KOs.

Country of Origin: USA

AL2040A

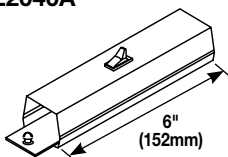

In-line Single Pole Switch – Single pole 120V switch. Two couplings furnished.

Country of Origin: Mexico

AL2047

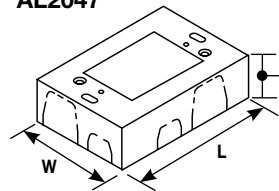

Shallow Switch & Receptacle Box – Designed for standard shallow switches and receptacles. Base has open back plate for mounting to existing wall box and solid back plate insert with 1/2" and 3/4" KO to close opening.

Country of Origin: USA

CAT. NO.	L	W	D	GANG #
AL2047	4 5/8" (117mm)	3 1/16" (73mm)	1 3/8" (35mm)	1
AL2047-2	4 5/8" (117mm)	4 27/32" (121mm)	1 3/8" (35mm)	2

AL2043TR

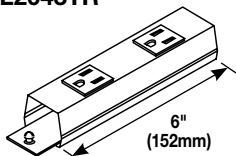

In-line Receptacle – Two 15A, 120V U-ground factory wired receptacles. Couplings furnished. Receptacles are tamper-resistant.

Country of Origin: USA

Nonmetallic Plugmold® Multioutlet Assemblies

Nonmetallic Plugmold Multioutlet Systems provides a versatile solution for many applications. Plugmold sections offer single or alternating circuits, standard or isolated ground receptacles, and Snapicoil® harnesses of prewired receptacles or cord ended units.

Nonmetallic Plugmold has a textured ivory finish with duplex receptacles, and can be customized to accommodate virtually any application.



Nonmetallic Plugmold Multioutlet Systems are available in a variety of configurations.

Plugmold NM2000 Series Nonmetallic Multioutlet Systems

Plugmold NM2000 Series Wire Fill Capacities for Power				
CABLE TYPE	WIRE SIZE THHN/THWN	O.D.		NUMBER OF CONDUCTORS (40% FILL) NM2000/NM2400
		Inches	(mm)	
POWER WIRING WITHOUT DEVICES	10 AWG	0.164	(4.2)	15
	12 AWG	0.130	(3.3)	31
	14 AWG	0.111	(2.8)	45
POWER WIRING WITH DEVICES (Plugmold Series)	10 AWG	0.153	(3.9)	—
	12 AWG	0.122	(3.1)	8 *
	14 AWG	0.105	(2.7)	8 *

* Including one hot, neutral, and ground wire from the receptacle.

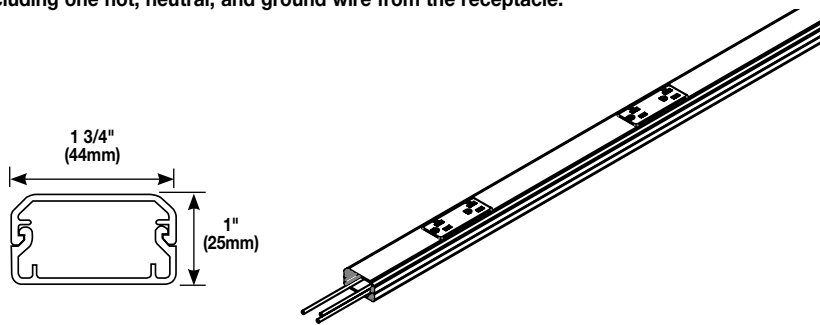

Plugmold NM2000 Series Nonmetallic Multioutlet Systems

Plugmold NM2000 Series Nonmetallic Part Numbering System

NM2000 Series Nonmetallic Plugmold Series – Example: NM20GB306



N M	2 0	G B	3	0 6
COLOR:	AMPERAGE:	WIRING CONFIGURATION:	LENGTH:	CENTER DISTANCE:
Nonmetallic = NM	20 = 15A 24 = 20A	GB = GB GBA = GBA IG = IG*	48" (1.2m) = 4 60" (1.5m) = 5 72" (1.8m) = 6	9" (229mm) = 9 12" (305mm) = 12 18" (457mm) = 18 30" (760mm) = 30

NOTE: Not all combinations of color, wiring configurations, length, and center distance are available as standard products. For additional information on custom options, contact Wiremold Technical Support at 1-800-621-0049.

NOTE: NM2000 Series Nonmetallic Plugmold products are available in an ivory finish with ivory receptacles.

* All NM2000 Series Plugmold products include two (2) NM2010B Blank End Fittings unless otherwise indicated in the product description.

Plugmold NM2000 Series Raceway Wiring Configurations

			With Snapicoil	
GB Series: 3-wire, #12 THHN (1 hot, 1 neutral and 1 ground), 1 circuit; has insulated grounding conductor.	GBA Series: 4-wire, #12 THHN (2 hot, 1 neutral and 1 ground), 2 circuit; outlets wired alternately; has insulated grounding conductor.	IG Series: 3-wire, #12 THHN (1 hot, 1 neutral and 1 ground), 1 circuit; has insulated-isolated grounding conductor. Orange receptacles.	GB Series: 3-wire, #12 THHN (1 hot, 1 neutral and 1 ground), 1 circuit; has insulated grounding conductor.	GBA Series: 4-wire, #12 THHN (2 hot, 1 neutral and 1 ground), 2 circuit; outlets wired alternately; has insulated grounding conductor.

NOTE: SNAPICOIL REELS on custom order. Snapicoil harness is available on reels if lengths greater than 50' are needed, or if multiple lengths are required for production-type jobs. The maximum length per reel is 240' for Snapicoil with outlets 12" and 18" on centers; 500' with outlets 30" on center. Packaging includes the necessary number of lengths of base, holecut cover, wire clips, and couplings for complete installation. Price and delivery information should be obtained prior to specifying or ordering. To specify or order, add "R" to the Snapicoil number. Ex: NM20GB12R. Other outlet spacings available on custom order.

Receptacles are made from high impact thermoplastic. Snapicoil packaging includes the necessary lengths of NM2000B Base, NM2000C Hole Cut Cover, NM2000WC Wire Clips, and NM2001 Couplings for complete installation.

Cord-Ended Nonmetallic Plugmold Multioutlet Systems

CAT NO.	UNIT LENGTH	OUTLETS QUANTITY	CORD SET LENGTH	TYPE	SWITCH	CIRCUIT BREAKER	HOUSING
NM20-C3	3' (.92m)	3 Duplex	6' (1.8m)	14/3 SJT	Yes	Yes	PVC-Ivory
NM20-C4	4' (1.2m)	4 Duplex	6' (1.8m)	14/3 SJT	Yes	Yes	PVC-Ivory
NM20-C5	5' (1.5m)	5 Duplex	6' (1.8m)	14/3 SJT	Yes	Yes	PVC-Ivory
NM20-C6	6' (1.8m)	6 Duplex	6' (1.8m)	14/3 SJT	Yes	Yes	PVC-Ivory

Plugmold NM2000 Series Raceway with Snapicoil Harness

CATALOG NO.	LENGTH	WIRING CONFIG	OUTLETS (15A 120V NEMA 5-15SR)		HOLE CUT COVER		HOUSING
			CENTER DISTANCE	QUANTITY	QUANTITY	LENGTH	
NM20GB12	48'	GB	12" (152mm)	24 Duplex	8	6' (1.8m)	PVC-Ivory
NM20GBA12	48'	GBA	12" (305mm)	24 Duplex	8	6' (1.8m)	PVC-Ivory

Plugmold NM2000 onmetallic Multioutlet Systems Ordering Information

Product	Description/Specifications																																																																																										
Plugmold NM2000 Series	Available in 4' (1.2m), 5' (1.5m) and 6' (1.8m) lengths with 9" (229mm), 12" (305mm) and 18" (457mm) and 30" (762mm) receptacle spacing. 15A receptacles. 3-wire, #12 THHN (1 hot, 1 neutral, and insulated ground conductor). Packed 2 per carton. Each unit supplied with two (2) Blank End Fittings.																																																																																										
	<table border="1"> <thead> <tr> <th>CATALOG NO.</th> <th>FINISH</th> <th>LENGTH Feet (mm)</th> <th>WIRING CONFIG</th> <th>CENTER DISTANCE Inches (mm)</th> <th>OUTLETS QUANTITY & TYPE</th> </tr> </thead> <tbody> <tr> <td>NM20GB412</td> <td>Nonmetallic</td> <td>4' (1.2m)</td> <td>GB</td> <td>12" (305mm)</td> <td>4 Duplex 15A</td> </tr> <tr> <td>NM20GBA412</td> <td>Nonmetallic</td> <td>4' (1.2m)</td> <td>GBA</td> <td>12" (305mm)</td> <td>4 Duplex 15A</td> </tr> <tr> <td>NM20IG412</td> <td>Nonmetallic</td> <td>4' (1.2 m)</td> <td>GB</td> <td>12" (305mm)</td> <td>4 Duplex 15A</td> </tr> <tr> <td>NM20GB512</td> <td>Nonmetallic</td> <td>5' (1.5m)</td> <td>GB</td> <td>12" (305mm)</td> <td>5 Duplex 15A</td> </tr> <tr> <td>NM20GB515</td> <td>Nonmetallic</td> <td>5' (1.5m)</td> <td>GB</td> <td>15" (381mm)</td> <td>4 Duplex 15A</td> </tr> <tr> <td>NM20GB530</td> <td>Nonmetallic</td> <td>5' (1.5m)</td> <td>GB</td> <td>30" (760mm)</td> <td>2 Duplex 15A</td> </tr> <tr> <td>NM20GBA512</td> <td>Nonmetallic</td> <td>5' (1.5m)</td> <td>GBA</td> <td>12" (305mm)</td> <td>5 Duplex 15A</td> </tr> <tr> <td>NM20IG512</td> <td>Nonmetallic</td> <td>5' (1.5m)</td> <td>IG</td> <td>12" (305mm)</td> <td>5 Duplex 15A</td> </tr> <tr> <td>NM20GB609</td> <td>Nonmetallic</td> <td>6' (1.8m)</td> <td>GB</td> <td>9" (229mm)</td> <td>8 Duplex 15A</td> </tr> <tr> <td>NM20GB612</td> <td>Nonmetallic</td> <td>6' (1.8m)</td> <td>GB</td> <td>12" (305mm)</td> <td>6 Duplex 15A</td> </tr> <tr> <td>NM20GB618</td> <td>Nonmetallic</td> <td>6' (1.8m)</td> <td>GB</td> <td>18" (457mm)</td> <td>4 Duplex 15A</td> </tr> <tr> <td>NM20GBA609</td> <td>Nonmetallic</td> <td>6' (1.8m)</td> <td>GBA</td> <td>9" (229mm)</td> <td>8 Duplex 15A</td> </tr> <tr> <td>NM20GBA612</td> <td>Nonmetallic</td> <td>6' (1.8m)</td> <td>GBA</td> <td>12" (305mm)</td> <td>6 Duplex 15A</td> </tr> <tr> <td>NM20IG612</td> <td>Nonmetallic</td> <td>6' (1.8m)</td> <td>IG</td> <td>12" (305mm)</td> <td>6 Duplex 15A</td> </tr> </tbody> </table>	CATALOG NO.	FINISH	LENGTH Feet (mm)	WIRING CONFIG	CENTER DISTANCE Inches (mm)	OUTLETS QUANTITY & TYPE	NM20GB412	Nonmetallic	4' (1.2m)	GB	12" (305mm)	4 Duplex 15A	NM20GBA412	Nonmetallic	4' (1.2m)	GBA	12" (305mm)	4 Duplex 15A	NM20IG412	Nonmetallic	4' (1.2 m)	GB	12" (305mm)	4 Duplex 15A	NM20GB512	Nonmetallic	5' (1.5m)	GB	12" (305mm)	5 Duplex 15A	NM20GB515	Nonmetallic	5' (1.5m)	GB	15" (381mm)	4 Duplex 15A	NM20GB530	Nonmetallic	5' (1.5m)	GB	30" (760mm)	2 Duplex 15A	NM20GBA512	Nonmetallic	5' (1.5m)	GBA	12" (305mm)	5 Duplex 15A	NM20IG512	Nonmetallic	5' (1.5m)	IG	12" (305mm)	5 Duplex 15A	NM20GB609	Nonmetallic	6' (1.8m)	GB	9" (229mm)	8 Duplex 15A	NM20GB612	Nonmetallic	6' (1.8m)	GB	12" (305mm)	6 Duplex 15A	NM20GB618	Nonmetallic	6' (1.8m)	GB	18" (457mm)	4 Duplex 15A	NM20GBA609	Nonmetallic	6' (1.8m)	GBA	9" (229mm)	8 Duplex 15A	NM20GBA612	Nonmetallic	6' (1.8m)	GBA	12" (305mm)	6 Duplex 15A	NM20IG612	Nonmetallic	6' (1.8m)	IG	12" (305mm)	6 Duplex 15A
	CATALOG NO.	FINISH	LENGTH Feet (mm)	WIRING CONFIG	CENTER DISTANCE Inches (mm)	OUTLETS QUANTITY & TYPE																																																																																					
	NM20GB412	Nonmetallic	4' (1.2m)	GB	12" (305mm)	4 Duplex 15A																																																																																					
	NM20GBA412	Nonmetallic	4' (1.2m)	GBA	12" (305mm)	4 Duplex 15A																																																																																					
	NM20IG412	Nonmetallic	4' (1.2 m)	GB	12" (305mm)	4 Duplex 15A																																																																																					
	NM20GB512	Nonmetallic	5' (1.5m)	GB	12" (305mm)	5 Duplex 15A																																																																																					
	NM20GB515	Nonmetallic	5' (1.5m)	GB	15" (381mm)	4 Duplex 15A																																																																																					
	NM20GB530	Nonmetallic	5' (1.5m)	GB	30" (760mm)	2 Duplex 15A																																																																																					
	NM20GBA512	Nonmetallic	5' (1.5m)	GBA	12" (305mm)	5 Duplex 15A																																																																																					
	NM20IG512	Nonmetallic	5' (1.5m)	IG	12" (305mm)	5 Duplex 15A																																																																																					
	NM20GB609	Nonmetallic	6' (1.8m)	GB	9" (229mm)	8 Duplex 15A																																																																																					
	NM20GB612	Nonmetallic	6' (1.8m)	GB	12" (305mm)	6 Duplex 15A																																																																																					
	NM20GB618	Nonmetallic	6' (1.8m)	GB	18" (457mm)	4 Duplex 15A																																																																																					
	NM20GBA609	Nonmetallic	6' (1.8m)	GBA	9" (229mm)	8 Duplex 15A																																																																																					
NM20GBA612	Nonmetallic	6' (1.8m)	GBA	12" (305mm)	6 Duplex 15A																																																																																						
NM20IG612	Nonmetallic	6' (1.8m)	IG	12" (305mm)	6 Duplex 15A																																																																																						

Product	Description/Specifications																																																						
Plugmold NM2400 Series	Available in 4' (1.2m), 5' (1.5m) and 6' (1.8m) lengths with 9" (229mm), 12" (305mm) and 18" (457mm) and 30" (762mm) receptacle spacing. 20A receptacles. 3-wire, #12 THHN (1 hot, 1 neutral, and insulated ground conductor). Packed 2 per carton. Each unit supplied with two (2) Blank End Fittings.																																																						
	<table border="1"> <thead> <tr> <th>CATALOG NO.</th> <th>FINISH</th> <th>LENGTH Feet (mm)</th> <th>WIRING CONFIG</th> <th>CENTER DISTANCE Inches (mm)</th> <th>OUTLETS QUANTITY & TYPE</th> </tr> </thead> <tbody> <tr> <td>NM24GB412</td> <td>Nonmetallic</td> <td>4' (1.2m)</td> <td>GB</td> <td>12" (305mm)</td> <td>4 Duplex 20A</td> </tr> <tr> <td>NM24GBA412</td> <td>Nonmetallic</td> <td>4' (1.2m)</td> <td>GBA</td> <td>12" (305mm)</td> <td>4 Duplex 20A</td> </tr> <tr> <td>NM24GB512</td> <td>Nonmetallic</td> <td>5' (1.5m)</td> <td>GB</td> <td>12" (305mm)</td> <td>5 Duplex 20A</td> </tr> <tr> <td>NM24GB530</td> <td>Nonmetallic</td> <td>5' (1.5m)</td> <td>GB</td> <td>30" (760mm)</td> <td>2 Duplex 20A</td> </tr> <tr> <td>NM24GBA512</td> <td>Nonmetallic</td> <td>5' (1.5m)</td> <td>GBA</td> <td>12" (305mm)</td> <td>5 Duplex 20A</td> </tr> <tr> <td>NM24GB612</td> <td>Nonmetallic</td> <td>6' (1.8m)</td> <td>GB</td> <td>12" (305mm)</td> <td>6 Duplex 20A</td> </tr> <tr> <td>NM24GB618</td> <td>Nonmetallic</td> <td>6' (1.8m)</td> <td>GB</td> <td>18" (457mm)</td> <td>4 Duplex 20A</td> </tr> <tr> <td>NM24GBA612</td> <td>Nonmetallic</td> <td>6' (1.8m)</td> <td>GB A</td> <td>12" (305mm)</td> <td>6 Duplex 20A</td> </tr> </tbody> </table>	CATALOG NO.	FINISH	LENGTH Feet (mm)	WIRING CONFIG	CENTER DISTANCE Inches (mm)	OUTLETS QUANTITY & TYPE	NM24GB412	Nonmetallic	4' (1.2m)	GB	12" (305mm)	4 Duplex 20A	NM24GBA412	Nonmetallic	4' (1.2m)	GBA	12" (305mm)	4 Duplex 20A	NM24GB512	Nonmetallic	5' (1.5m)	GB	12" (305mm)	5 Duplex 20A	NM24GB530	Nonmetallic	5' (1.5m)	GB	30" (760mm)	2 Duplex 20A	NM24GBA512	Nonmetallic	5' (1.5m)	GBA	12" (305mm)	5 Duplex 20A	NM24GB612	Nonmetallic	6' (1.8m)	GB	12" (305mm)	6 Duplex 20A	NM24GB618	Nonmetallic	6' (1.8m)	GB	18" (457mm)	4 Duplex 20A	NM24GBA612	Nonmetallic	6' (1.8m)	GB A	12" (305mm)	6 Duplex 20A
	CATALOG NO.	FINISH	LENGTH Feet (mm)	WIRING CONFIG	CENTER DISTANCE Inches (mm)	OUTLETS QUANTITY & TYPE																																																	
	NM24GB412	Nonmetallic	4' (1.2m)	GB	12" (305mm)	4 Duplex 20A																																																	
	NM24GBA412	Nonmetallic	4' (1.2m)	GBA	12" (305mm)	4 Duplex 20A																																																	
	NM24GB512	Nonmetallic	5' (1.5m)	GB	12" (305mm)	5 Duplex 20A																																																	
	NM24GB530	Nonmetallic	5' (1.5m)	GB	30" (760mm)	2 Duplex 20A																																																	
	NM24GBA512	Nonmetallic	5' (1.5m)	GBA	12" (305mm)	5 Duplex 20A																																																	
	NM24GB612	Nonmetallic	6' (1.8m)	GB	12" (305mm)	6 Duplex 20A																																																	
	NM24GB618	Nonmetallic	6' (1.8m)	GB	18" (457mm)	4 Duplex 20A																																																	
	NM24GBA612	Nonmetallic	6' (1.8m)	GB A	12" (305mm)	6 Duplex 20A																																																	

NOTE: NM2000 Series Nonmetallic Plugmold products are available in an ivory finish with ivory receptacles.
All NM2000 Series Plugmold products include two (2) NM2010B Blank End Fittings and one (1) NM2001 Base Coupling unless otherwise indicated in the product description.

Plugmold NM2000 Series Nonmetallic Multioutlet Systems Ordering Information

NM2000

Base and Cover – Extruded PVC, ivory textured finish.

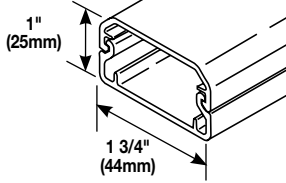

Country of Origin: USA

Cross-Sectional Area:
1.14in² (735mm²)

NM2010B

Blank End Fitting – Use with NM2000 Series.

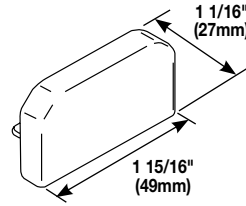

Country of Origin: USA

NM2011

90° Flat Elbow – For right angle turns on same surface.

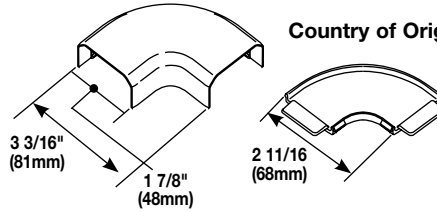

Country of Origin: USA

ITEM	CAT. NO.	LENGTH	MATERIAL
Base	NM2000B	8' (2.4m)	PVC-Ivory
Cover	NM2000C	8' (2.4m)	PVC-Ivory
Base & Cover	NM2000BC	5' (1.52m)	PVC-Ivory

NM2003

Supporting Clip – Mount to surface with No. 8 flathead screw. Use with NM2000 Series.

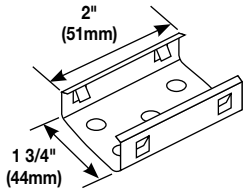

Country of Origin: USA

NM2015

Tee – For branches at right angles.

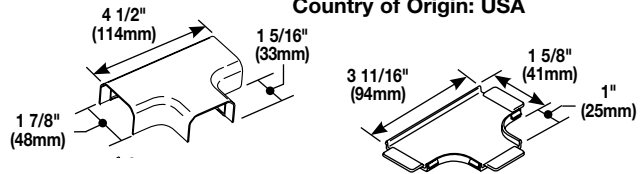

Country of Origin: USA

W30/W30G

Pressure-Type Wire Connectors – **W30** – For common connection of two, three, or four No. 12 or No. 14 solid copper conductors (White). **W30G** – For connection of equipment grounding of 2, 3, or 4 solid conductors No. 14 or No. 12 AWG (Green). 300V maximum; 20A 105° C maximum.



Country of Origin: USA

NOTE: Not for use with aluminum conductors.

NM2017

Internal Elbow – For right turns at inside corners.

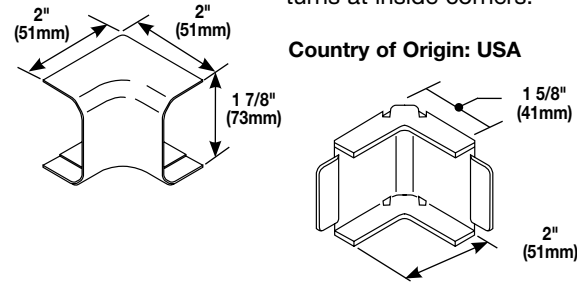

Country of Origin: USA

NM2006

Cover Clip – For covering joint where lengths of NM2000 Series cover or base adjoin. Use with NM2000 Series.

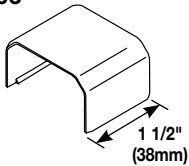

Country of Origin: USA

NM2018

External Elbow – Used for making 90° turns at outside corners.

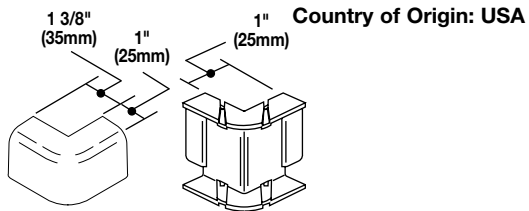

Country of Origin: USA

NM2010A

Entrance End – Has 1/2" trade size KO on end and bottom. Use with NM2000 Series.

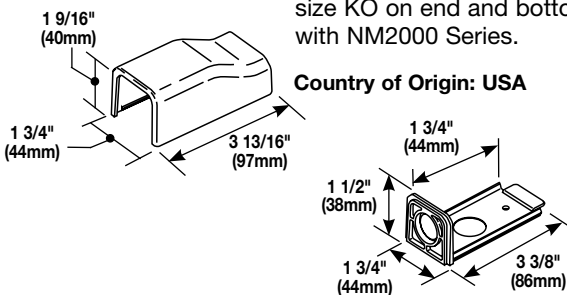

Country of Origin: USA

NOTE: NM2000 Series fittings work with both NM20 (15A) and NM24 (20A) Plugmold Multioutlet Systems.

Plugmold NM2000 Series Nonmetallic Multioutlet Systems Ordering Information

NM2051H

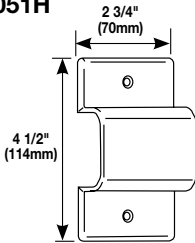

Wall Box Adapter – For feeding raceway from an existing wall outlet; horizontal applications. Provides complete access to wall box for connections.

Country of Origin: USA

NM2048 NM2048-2

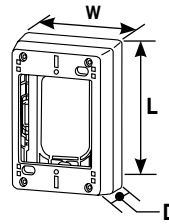

Sure-Snap® Device Box – Cover snaps onto base, no screws required. Cover has twistouts on all sides. Rectangular KO in base for extension to wall box.

Country of Origin: USA

NM2051V

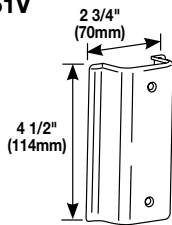

Wall Box Adapter – For feeding raceway from an existing wall outlet; vertical applications. Provides complete access to wall box for connections.

Country of Origin: USA

CAT. NO.	L	W	D	GANG #
NM2048	4 3/4" (121mm)	3" (76mm)	1 3/4" (44mm)	1
NM2048-2	4 3/4" (121mm)	4 7/8" (124mm)	1 3/4" (44mm)	2

NM2027-15 NM2027-20

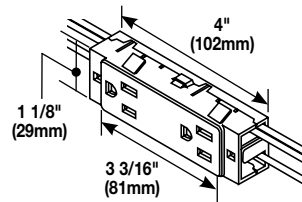

Replacement Receptacles – 15A and 20A replacement devices. 6" (152mm) wire leads each side. Used to replace faulty receptacles in Plugmold Strips, not for installation in blank raceway base.

Country of Origin: USA

NM2044

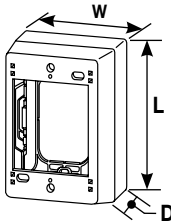

Extra Deep Device Box – For mounting power/communication device when additional depth is required. Has combination twistouts for 2700, 2800, 2900, and NM2000.

Country of Origin: USA

CAT. NO.	L	W	D	GANG #
NM2044	4 3/4" (121mm)	3" (76mm)	2 3/4" (44mm)	1
NM2044-2	4 3/4" (121mm)	4 7/8" (124mm)	2 3/4" (44mm)	2

NOTE: NM2000 Series fittings work with both NM20 (15A) and NM24 (20A) Plugmold Multioutlet Systems.

NOTE: All brand and product names referenced in this document are registered trademarks or trademarks of their respective holders.



NOTE: The paper used to print this document is an environmentally responsible paper with 10% post consumer waste, with FSC and SFI Chain of Custody certifications, Lacey Act complaint. 100% of the electricity used to manufacture Flo sheets is generated with Green-e certified renewable energy.



Legrand, North America
60 Woodlawn Street
West Hartford, CT 06110
1.877.BY.LEGRAND (295.3472)
www.legrand.us

Canada
905.738.9195
www.legrand.ca

FOLLOW US

