

TECHNICAL INFORMATION BULLETIN

LAMP AND BALLAST KIT

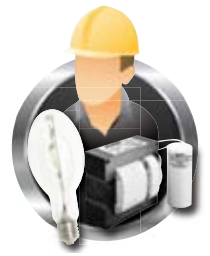

Ordering Information

Order code: 61839

ANSI code: M98

Description: LBK/BMH0070/TRITAP/C/HX/MED

System: Pulse Start Metal Halide

UPC: 69549618398

Ballast Information

Line Voltage	120/277/347V
Regulation	
Line Volts	+/-10%
Line Watts	+/-10%
Frequency	60 Hz
Circuit Type	CWA
Power Factor (min)	90%
Insulation Class	H(180°)
Min. Ambient Starting Temp.	-20° F or -30° C

Line Voltage (Volts)	120	277	347
Line Current (Amps)			
Operating	4.0	1.70	1.40
Open Circuit	3.50	1.60	1.30
Starting	2.90	1.30	1.00
Input Watts (W)	458	458	458
Open Circuit Voltage (V)	300	300	300
Drop Out Voltage (V)	60	140	175
UL(1029) Bench Top Rise	B	D	D
Recommended Fuse (Amps)	10	5	4
HIGH POTENTIAL TEST (VOLTS)			
1 Minute	2000		
2 Seconds	2500		
Open Circuit Voltage Test (volts)	270-330		
Short-Circuit Current Test (Amps)			
Secondary Current	3.4 - 4.2		
Input Current (Amps)	2.50 - 3.10	1.05 - 1.40	0.85 - 1.10

4 1/4" x 4 3/4" CORE

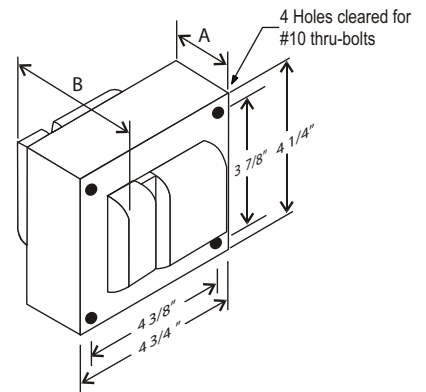

CORE AND COIL

Dimension A (inches)	2.00
Dimension B (inches)	3.70
Weight (Lbs)	13.00
Lead Lengths (inches)	12

CAPACITOR

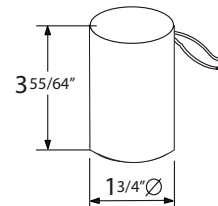

RATING
24 Mfd ± 3%
400 VAC MIN
Dry Film Capacitor
Thermal Plastic Case
Max. Case Temp 100° C
NO PCB'S

BRACKET

CORE & COIL
MOUNTING BRACKET

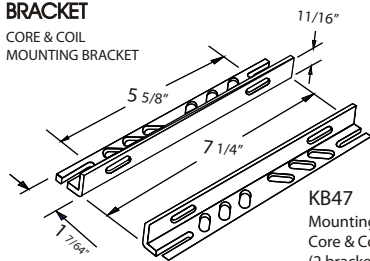

KB47
Mounting bracket for
Core & Coil Ballasts
(2 brackets with thru bolts)

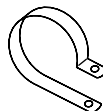

C-01

MOUNTING CLIP for round
case (Furnished as standard
with B suffix ballast)

WIRING DIAGRAM

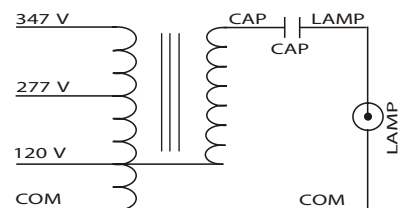

120/277/347 VOLT CONNECTION



Data is based upon tests performed in a controlled environment and representative of relative performance. Actual performance can vary depending on operating conditions. Specifications are subject to change without notice.



www.standardpro.com

TECHNICAL INFORMATION BULLETIN

LAMP AND BALLAST KIT

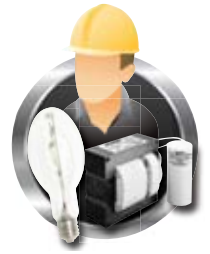

Ordering Information

Order code: 61839

ANSI code: M98

Description: LBK/BMH0070/TRITAP/C/HX/MED

System: Pulse Start Metal Halide

UPC: 69549618398

Lamp Information

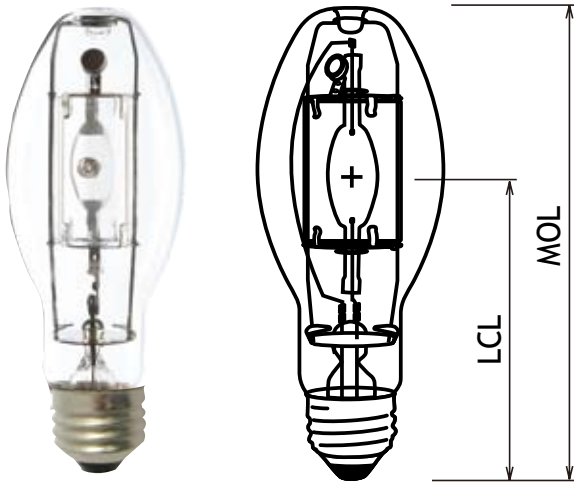

Wattage (W):	70
Initial lumens (lm):	5 600
Mean lumens (lm):	3 600
Lumens per watt (lm/W):	80
Lamp voltage (V):	85
Colour temperature (K):	4 000
Chromaticity (x,y):	0.385, 0.390
CRI:	65
Average life (hrs):	15 000
Lamp lumen depreciation:	0.65% @ 6 000 hrs
Warm up time to 90% (min):	1-2
Hot restart time to 90% (min):	2-4
Burn Position:	Universal
Dimming:	50% rated power
Max base temperature:	210
Max lamp temperature:	400
Socket pulse rating (kV):	4

ALL TOUTES

Spectral Distribution

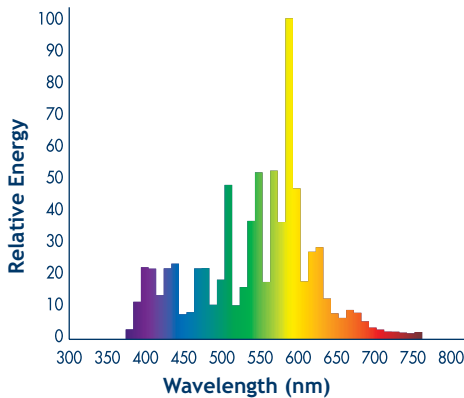

Physical data / Requirements

Shape:	EDX17
Base:	Med Base E26
Finish:	Clear
Luminaire rating:	Open Rated
Diameter (mm/in.):	54.0 (2 1/8)
MOL (mm/in.):	138.0 (5 7/16)
LCL (mm/in.):	86.0 (3 3/8)
Effective arc length (mm):	9
Mercury Content (mg):	8.5

Warning

“R” **WARNING:** this lamp can cause serious skin burn and eye inflammation from shortwave ultraviolet radiation if the outer envelope of the lamp is broken or punctured. Do not use where people will remain for more than a few minutes unless adequate shielding or other safety precautions are used. Lamps that will automatically extinguish when the outer envelope is broken or punctured are commercially available. Complies with USA Federal Standard 21 CFR 1040.30 and Canada Standard SOR/80-381.



www.standardpro.com