

# Condulet conduit bodies – cast iron or aluminum

See page 8 for gaskets and covers

## Applications:

Conduit outlet bodies are installed in conduit systems to:

- Act as pull outlets for conductors being installed
- Provide openings for making splices and taps in conductors
- Connect conduit sections
- Provide taps for branch conduit runs
- Make 90° bends in conduit runs
- Provide for access to conductors for maintenance and future system changes

## Features:

Conduit outlet bodies:

- Form 7 Condulet® outlet bodies approach conduit in size for neat, compact installations
- Form 8 and Mark 9 bodies provide more room for heavier conductors
- Many shapes and sizes are available for rigid threaded conduit – for complete listings, see pages 6-13
- Conduit hubs have tapered threads and feature integral bushings for protection of wire insulation
- Form 7 has exclusive SNAPTIGHT™ and wedge nut cover attachment to provide clear, unobstructed cover opening
- Certified to UL50E (dusttight) when used with cover containing integral gasket

Gaskets:

Solid gaskets

- Are used with blank covers
- For Mark 9, can be converted to open type gaskets by tearing out center section along scored lines – ½" to 2" sizes
- For Form 7 are used with all covers

Open gaskets

- For Form 8 – ½" to 4" sizes
- For Mark 9 – 2½" to 4" sizes

Blank covers:

- Stainless steel cover screws are standard on Form 7, Form 8 and Mark 9 covers
- Form 7 – wedge nut design facilitates installation and removal; nuts are held captive in cover; covers can be used with or without gaskets; SNAPTIGHT Form 7 covers with integral sealing gaskets are installed without the use of screws, reducing installation time and costs; covers are reusable
- Form 8 – two cover screws on ½" to 2" covers and four cover screws on 2½" and larger covers, to provide tight cover and gasket assembly; Feraloy iron alloy covers have dome shapes for added strength and extra wiring room
- Mark 9 – self-retaining cover screws

## Certifications and compliances:

Outlet bodies:

- UL standard: 514B
- Fed. Spec.: W-C-586D
- CSA standard: C22.2 No. 18
- NEMA 3R raintight (when installed with cover and gasket)
- UL50E dusttight Type 12

## Standard materials:

- Form 7, Form 8 outlet bodies – Feraloy iron alloy
- Mark 9 outlet bodies – copper-free aluminum

## Standard finishes:

- Form 7, Form 8 outlet bodies – electrogalvanized with aluminum acrylic paint
- Mark 9 outlet bodies – natural

## Options:

Description

Suffix

**Form 7 body and cover only:**

- Copper-free aluminum ..... **SA**
- Corro-free™ epoxy powder coat, external body only ..... **S752**
- Corro-free epoxy powder coat, internal and external ..... **S753**



**Form 7**



**Mark 9**



**Form 8**













**Mogul**

# Condulet conduit bodies – cast iron or aluminum

See pages 10-13 for dimensions

## Ordering information – threaded rigid bodies:

Shape	Style	Hub size									
		1/2"	3/4"	1"	1 1/4"	1 1/2"	2"	2 1/2"	3"	3 1/2"	4"
<b>C</b>											
	Form 7	C17	C27	C37	C47	C57	C67	C77	C87		
	Form 8	C18	C28	C38	C448	C58	C68	C78	C88		
	Mark 9	C19	C29	C39	C49	C59	C69	C789	C889	C989	C1089
<b>E</b>											
	Form 7	E17	E27	E37							
<b>L</b>											
	Form 7	L17	L27	L37	L47	L57	L67				
Double faced – may be used as LL or LR – has 2 openings, one of which is furnished with a blank sheet steel cover											
<b>LB</b>											
	Form 7	LB17	LB27	LB37	LB47	LB57	LB67	LB777	LB87	LB97	LB107
	Form 8	LB18	LB28	LB38	LB448	LB58	LB68	LB78	LB888	LB98	LB108
	Mark 9	LB19	LB29	LB39	LB49	LB59	LB69	LB789	LB889		LB1089
<b>LL</b>											
	Form 7	LL17	LL27	LL37	LL47	LL57	LL67	LL777	LL87	LL97	LL107
	Form 8	LL18	LL28	LL38	LL448	LL58	LL68	LL78	LL888		
	Mark 9	LL19	LL29	LL39	LL49	LL59	LL69	LL789	LL889	LL989	LL1089
<b>LR</b>											
	Form 7	LR17	LR27	LR37	LR47	LR57	LR67	LR777	LR87	LR97	LR107
	Form 8	LR18	LR28	LR38	LR448	LR58	LR68	LR78	LR888		
	Mark 9	LR19	LR29	LR39	LR49	LR59	LR69	LR789	LR889	LR989	LR1089
<b>T</b>											
	Form 7	T17	T27	T37	T47	T57	T67	T77	T87	T97	T107
	Form 8	T18	T28	T38	T448	T58	T68	T78	T88		
	Mark 9	T19	T29	T39	T49	T59	T69	T789	T889	T989	T1089
<b>TA</b>											
	Form 7	TA17	TA27	TA37	TA47	TA57	TA67				
<b>TB</b>											
	Form 7	TB17	TB27	TB37	TB47	TB57	TB67				
	Form 8	TB18	TB28	TB38	TB448	TB58	TB68				
	Mark 9	TB19	TB29	TB39	TB49	TB59	TB69				
<b>U</b>											
	Form 7	U17	U27	U37	U47	U57	U67				
<b>X</b>											
	Form 7	X17	X27	X37	X47	X57	X67				
	Form 8	X18	X28	X38	X448	X58	X68				
	Mark 9	X19	X29	X39							

# Condulet conduit bodies – cast iron or aluminum

## Covers and gaskets

### Ordering information – blank covers:



Sheet steel

Size	Cat. # Form 7 wedge nut	Cat. # Form 7 SNAPTIGHT™ <sup>A</sup>	Cat. # Form 7 wedge nut with integral gasket <sup>C</sup>	Cat. # Form 8 <sup>E</sup>	Cat. # Form 8 with integral gasket <sup>C</sup>
1/2"	170	170SG	170G	180 <sup>E</sup>	180G <sup>E</sup>
3/4"	270	270SG	270G	280 <sup>E</sup>	280G <sup>E</sup>
1"	370	370SG	370G	380 <sup>E</sup>	380G <sup>E</sup>
1 1/4"	470	470SG	470G	480 <sup>E</sup>	480G <sup>E</sup>
1 1/2"	570	570SG	570G	580 <sup>E</sup>	580G <sup>E</sup>
2"	670	670SG	670G	680 <sup>E</sup>	680G <sup>E</sup>
2 1/2"	870		870G	880	
3"	870		870G	880	
3 1/2"	970		970G	980	
4"	970		970G	980	



Sheet aluminum



Feraloy iron alloy



Cast aluminum

Size	Cat. # Mark 9	Cat. # Mark 9 with integral gasket <sup>C</sup>	Cat. # Form 7	Cat. # Form 7 with integral gasket <sup>C</sup>	Cat. # Form 7 wedge nut	Cat. # Form 7 wedge nut with integral gasket <sup>C</sup>	Cat. # Form 8 <sup>D</sup>	Cat. # Form 7 wedge nut
1/2"	190	190G	170 SA	170G SA	170F	170FG	180F <sup>D</sup>	170F SA
3/4"	290	290G	270 SA	270G SA	270F	270FG	280F <sup>D</sup>	270F SA
1"	390	390G	370 SA	370G SA	370F	370FG	380F <sup>D</sup>	370F SA
1 1/4"	490	490G	470 SA	470G SA	470F	470FG	480F <sup>D</sup>	470F SA
1 1/2"	590	590G	570 SA	570G SA	570F	570FG	580F	570F SA
2"	690	690G	670 SA	670G SA	670F	670FG	680F	670F SA
2 1/2"	889		870 SA		870F		880F	870F SA
3"	889		870 SA		870F		880F	870F SA
3 1/2"	989		970 SA		970F		980F	970F SA
4"	989		970 SA		970F		980F	970F SA

### Ordering information – neoprene solid gaskets:



Size	Cat. # Form 7	Cat. # Form 8 <sup>E</sup>	Cat. # Mark 9 <sup>F</sup>
1/2"	GASK571	GASK851N	GASK1941
3/4"	GASK572	GASK852N	GASK1942
1"	GASK573	GASK853N	GASK1943
1 1/4"	GASK574	GASK854N	GASK1944
1 1/2"	GASK575	GASK805N	GASK1945
2"	GASK576	GASK806N	GASK1946
2 1/2"	GASK578	GASK808N	GASK808N
3"	GASK578	GASK808N	GASK808N
3 1/2"	GASK579	GASK809N	GASK809N
4"	GASK579	GASK809N	GASK809N

- <sup>A</sup> Form 7 SNAPTIGHT covers with integral sealing gasket are installed without the use of screws.
- <sup>B</sup> Two cover screws on 1/2" to 2" Form 8 covers and four cover screws on 2 1/2" and larger Form 8 covers.
- <sup>C</sup> Urethane integral gaskets.
- <sup>D</sup> Two cover screws on 1/2" to 1 1/4" Form 8 covers and four cover screws on 1 1/2" and larger Form 8 covers.
- <sup>E</sup> 1/2" to 1 1/4" are solid gaskets; 1 1/2" to 4" are open gaskets.
- <sup>F</sup> 1/2" to 2" are solid gaskets; 2 1/2" to 4" are open gaskets.

# Condulet conduit bodies – cast iron or aluminum

## Dimensions (in inches):

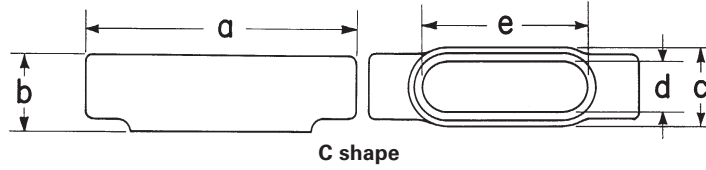

### Form 7 C

Hub size	½"	¾"	1"	1¼"	1½"	2"	2½"	3"
a	5 <sup>5</sup> / <sub>8</sub>	6	7	7 <sup>7</sup> / <sub>16</sub>	8 <sup>7</sup> / <sub>16</sub>	9 <sup>7</sup> / <sub>16</sub>	12	11 <sup>3</sup> / <sub>4</sub>
b	1 <sup>3</sup> / <sub>8</sub>	1 <sup>5</sup> / <sub>8</sub>	1 <sup>7</sup> / <sub>8</sub>	2 <sup>5</sup> / <sub>16</sub>	2 <sup>9</sup> / <sub>16</sub>	3 <sup>1</sup> / <sub>8</sub>	3 <sup>5</sup> / <sub>8</sub>	4 <sup>3</sup> / <sub>8</sub>
c	1 <sup>3</sup> / <sub>8</sub>	1 <sup>3</sup> / <sub>16</sub>	1 <sup>3</sup> / <sub>4</sub>	2 <sup>3</sup> / <sub>16</sub>	2 <sup>7</sup> / <sub>16</sub>	3	4 <sup>1</sup> / <sub>4</sub>	4 <sup>1</sup> / <sub>4</sub>
d	1 <sup>5</sup> / <sub>16</sub>	1 <sup>1</sup> / <sub>8</sub>	1 <sup>3</sup> / <sub>8</sub>	1 <sup>3</sup> / <sub>4</sub>	1 <sup>15</sup> / <sub>16</sub>	2 <sup>7</sup> / <sub>16</sub>	3 <sup>9</sup> / <sub>16</sub>	3 <sup>9</sup> / <sub>16</sub>
e	3 <sup>7</sup> / <sub>16</sub>	3 <sup>13</sup> / <sub>16</sub>	4 <sup>1</sup> / <sub>2</sub>	5	5 <sup>7</sup> / <sub>16</sub>	6 <sup>3</sup> / <sub>8</sub>	8 <sup>3</sup> / <sub>8</sub>	8 <sup>3</sup> / <sub>8</sub>

### Form 8 C

Hub size	½"	¾"	1"	1¼"	1½"	2"	2½"	3"
a	5 <sup>11</sup> / <sub>16</sub>	6 <sup>3</sup> / <sub>32</sub>	7 <sup>5</sup> / <sub>16</sub>	8 <sup>1</sup> / <sub>2</sub>	10 <sup>3</sup> / <sub>8</sub>	12 <sup>1</sup> / <sub>4</sub>	15 <sup>5</sup> / <sub>8</sub>	15 <sup>5</sup> / <sub>8</sub>
b	1 <sup>7</sup> / <sub>16</sub>	1 <sup>11</sup> / <sub>16</sub>	1 <sup>15</sup> / <sub>16</sub>	2 <sup>3</sup> / <sub>8</sub>	2 <sup>25</sup> / <sub>32</sub>	3 <sup>3</sup> / <sub>16</sub>	4 <sup>7</sup> / <sub>16</sub>	4 <sup>13</sup> / <sub>16</sub>
c	1 <sup>3</sup> / <sub>8</sub>	1 <sup>3</sup> / <sub>16</sub>	1 <sup>3</sup> / <sub>4</sub>	2 <sup>3</sup> / <sub>16</sub>	2 <sup>7</sup> / <sub>4</sub>	3 <sup>3</sup> / <sub>4</sub>	5	5
d	1	1 <sup>3</sup> / <sub>16</sub>	1 <sup>3</sup> / <sub>8</sub>	1 <sup>3</sup> / <sub>4</sub>	2 <sup>1</sup> / <sub>8</sub>	3	4 <sup>1</sup> / <sub>4</sub>	4 <sup>1</sup> / <sub>4</sub>
e	3 <sup>7</sup> / <sub>16</sub>	3 <sup>15</sup> / <sub>16</sub>	4 <sup>9</sup> / <sub>16</sub>	5 <sup>7</sup> / <sub>16</sub>	6 <sup>1</sup> / <sub>2</sub>	8 <sup>9</sup> / <sub>16</sub>	10 <sup>1</sup> / <sub>8</sub>	10 <sup>1</sup> / <sub>8</sub>

### Mark 9 C

Hub size	½"	¾"	1"	1¼"	1½"	2"	2½"	3"	3½"	4"
a	4 <sup>31</sup> / <sub>32</sub>	5 <sup>11</sup> / <sub>32</sub>	6 <sup>19</sup> / <sub>32</sub>	7 <sup>5</sup> / <sub>8</sub>	8 <sup>11</sup> / <sub>32</sub>	10 <sup>6</sup> / <sub>8</sub>	15 <sup>5</sup> / <sub>8</sub>	15 <sup>5</sup> / <sub>8</sub>	18 <sup>3</sup> / <sub>4</sub>	18 <sup>3</sup> / <sub>4</sub>
b	1 <sup>13</sup> / <sub>32</sub>	1 <sup>5</sup> / <sub>8</sub>	1 <sup>7</sup> / <sub>8</sub>	2 <sup>1</sup> / <sub>2</sub>	2 <sup>13</sup> / <sub>16</sub>	3 <sup>7</sup> / <sub>16</sub>	4 <sup>7</sup> / <sub>16</sub>	4 <sup>9</sup> / <sub>16</sub>	5 <sup>11</sup> / <sub>16</sub>	5 <sup>5</sup> / <sub>16</sub>
c	1 <sup>3</sup> / <sub>8</sub>	1 <sup>3</sup> / <sub>16</sub>	1 <sup>3</sup> / <sub>4</sub>	2 <sup>3</sup> / <sub>16</sub>	2 <sup>1</sup> / <sub>2</sub>	3 <sup>3</sup> / <sub>32</sub>	5	5	6 <sup>1</sup> / <sub>4</sub>	6 <sup>1</sup> / <sub>4</sub>
d	1 <sup>1</sup> / <sub>8</sub>	1 <sup>1</sup> / <sub>4</sub>	1 <sup>3</sup> / <sub>8</sub>	1 <sup>27</sup> / <sub>32</sub>	2 <sup>5</sup> / <sub>32</sub>	2 <sup>25</sup> / <sub>32</sub>	4 <sup>1</sup> / <sub>4</sub>	4 <sup>1</sup> / <sub>4</sub>	5 <sup>1</sup> / <sub>16</sub>	5 <sup>1</sup> / <sub>16</sub>
e	3 <sup>9</sup> / <sub>32</sub>	3 <sup>27</sup> / <sub>32</sub>	4 <sup>9</sup> / <sub>16</sub>	5 <sup>5</sup> / <sub>16</sub>	5 <sup>7</sup> / <sub>8</sub>	8 <sup>3</sup> / <sub>32</sub>	10 <sup>7</sup> / <sub>8</sub>	10 <sup>7</sup> / <sub>8</sub>	13 <sup>7</sup> / <sub>16</sub>	13 <sup>7</sup> / <sub>16</sub>

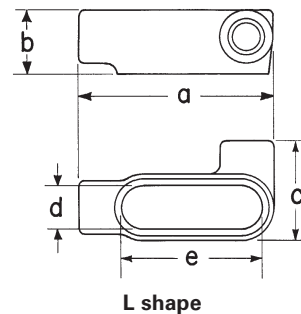
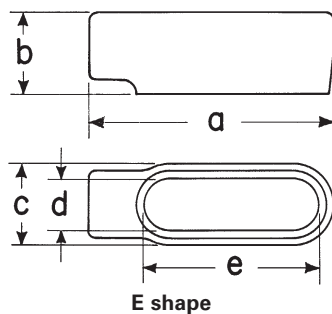

### Form 7 E

Hub size	½"	¾"	1"
a	4 <sup>9</sup> / <sub>16</sub>	5 <sup>3</sup> / <sub>16</sub>	6
b	1 <sup>3</sup> / <sub>8</sub>	1 <sup>5</sup> / <sub>8</sub>	1 <sup>7</sup> / <sub>8</sub>
c	1 <sup>3</sup> / <sub>8</sub>	1 <sup>3</sup> / <sub>16</sub>	1 <sup>3</sup> / <sub>4</sub>
d	1 <sup>5</sup> / <sub>16</sub>	1 <sup>1</sup> / <sub>8</sub>	1 <sup>3</sup> / <sub>8</sub>
e	3 <sup>7</sup> / <sub>16</sub>	3 <sup>13</sup> / <sub>16</sub>	4 <sup>1</sup> / <sub>2</sub>

### Form 7 L

Hub size	½"	¾"	1"	1¼"	1½"	2"
a	4 <sup>9</sup> / <sub>16</sub>	5 <sup>3</sup> / <sub>16</sub>	6	6 <sup>1</sup> / <sub>2</sub>	7 <sup>1</sup> / <sub>8</sub>	8 <sup>1</sup> / <sub>8</sub>
b	1 <sup>3</sup> / <sub>8</sub>	1 <sup>5</sup> / <sub>8</sub>	1 <sup>7</sup> / <sub>8</sub>	2 <sup>7</sup> / <sub>16</sub>	2 <sup>9</sup> / <sub>16</sub>	3 <sup>1</sup> / <sub>8</sub>
c	2 <sup>1</sup> / <sub>4</sub>	2 <sup>1</sup> / <sub>16</sub>	2 <sup>3</sup> / <sub>4</sub>	3 <sup>3</sup> / <sub>16</sub>	3 <sup>9</sup> / <sub>16</sub>	4 <sup>1</sup> / <sub>8</sub>
d	1 <sup>5</sup> / <sub>16</sub>	1 <sup>1</sup> / <sub>8</sub>	1 <sup>3</sup> / <sub>8</sub>	1 <sup>3</sup> / <sub>4</sub>	1 <sup>15</sup> / <sub>16</sub>	2 <sup>1</sup> / <sub>16</sub>
e	3 <sup>7</sup> / <sub>16</sub>	3 <sup>13</sup> / <sub>16</sub>	4 <sup>1</sup> / <sub>2</sub>	5	5 <sup>7</sup> / <sub>16</sub>	6 <sup>3</sup> / <sub>8</sub>

# Condulet conduit bodies – cast iron or aluminum

## Dimensions (in inches):

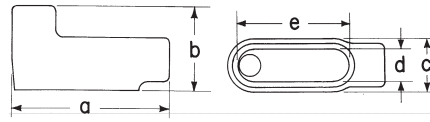

LB shape

### Form 7 LB

Hub size	½"	¾"	1"	1¼"	1½"	2"	2½"	3"	3½"	4"
a	4 <sup>9</sup> / <sub>16</sub>	5 <sup>3</sup> / <sub>16</sub>	6	6½	7 <sup>1</sup> / <sub>8</sub>	8 <sup>1</sup> / <sub>8</sub>	10½	10½	12 <sup>11</sup> / <sub>16</sub>	12 <sup>11</sup> / <sub>16</sub>
b	2¼	2½	2 <sup>7</sup> / <sub>8</sub>	3 <sup>5</sup> / <sub>16</sub>	3 <sup>11</sup> / <sub>16</sub>	4¼	5 <sup>1</sup> / <sub>8</sub>	5 <sup>7</sup> / <sub>8</sub>	6 <sup>9</sup> / <sub>16</sub>	7 <sup>1</sup> / <sub>16</sub>
c	1 <sup>3</sup> / <sub>8</sub>	1 <sup>3</sup> / <sub>16</sub>	1 <sup>3</sup> / <sub>4</sub>	2 <sup>3</sup> / <sub>16</sub>	2 <sup>1</sup> / <sub>16</sub>	3	4¼	4¼	5¼	5¼
d	1 <sup>5</sup> / <sub>16</sub>	1 <sup>1</sup> / <sub>8</sub>	1 <sup>3</sup> / <sub>8</sub>	1 <sup>3</sup> / <sub>4</sub>	1 <sup>15</sup> / <sub>16</sub>	2 <sup>1</sup> / <sub>16</sub>	3 <sup>3</sup> / <sub>16</sub>	3 <sup>3</sup> / <sub>16</sub>	4½	4½
e	3 <sup>3</sup> / <sub>16</sub>	3 <sup>15</sup> / <sub>16</sub>	4½	5	5 <sup>1</sup> / <sub>16</sub>	6 <sup>7</sup> / <sub>8</sub>	8 <sup>1</sup> / <sub>8</sub>	8 <sup>1</sup> / <sub>8</sub>	10¼	10¼

### Form 8 LB

Hub size	½"	¾"	1"	1¼"	1½"	2"	2½"	3"	3½"	4"
a	4 <sup>15</sup> / <sub>16</sub>	5 <sup>3</sup> / <sub>16</sub>	6 <sup>15</sup> / <sub>32</sub>	7 <sup>17</sup> / <sub>32</sub>	9 <sup>1</sup> / <sub>8</sub>	11	13 <sup>15</sup> / <sub>16</sub>	13 <sup>15</sup> / <sub>16</sub>	16 <sup>1</sup> / <sub>8</sub>	16 <sup>1</sup> / <sub>8</sub>
b	2 <sup>7</sup> / <sub>32</sub>	2 <sup>1</sup> / <sub>16</sub>	2 <sup>13</sup> / <sub>16</sub>	3 <sup>11</sup> / <sub>32</sub>	4 <sup>1</sup> / <sub>32</sub>	4 <sup>13</sup> / <sub>16</sub>	6 <sup>1</sup> / <sub>8</sub>	6 <sup>1</sup> / <sub>2</sub>	7 <sup>9</sup> / <sub>16</sub>	7 <sup>13</sup> / <sub>16</sub>
c	1 <sup>3</sup> / <sub>8</sub>	1 <sup>3</sup> / <sub>16</sub>	1 <sup>3</sup> / <sub>4</sub>	2 <sup>3</sup> / <sub>16</sub>	2 <sup>1</sup> / <sub>4</sub>	3 <sup>3</sup> / <sub>4</sub>	5	5	6¼	6¼
d	1	1 <sup>3</sup> / <sub>16</sub>	1 <sup>3</sup> / <sub>8</sub>	1 <sup>3</sup> / <sub>4</sub>	2 <sup>1</sup> / <sub>8</sub>	3	4¼	4¼	5 <sup>1</sup> / <sub>16</sub>	5 <sup>1</sup> / <sub>16</sub>
e	3 <sup>3</sup> / <sub>16</sub>	3 <sup>15</sup> / <sub>16</sub>	4 <sup>9</sup> / <sub>16</sub>	5 <sup>5</sup> / <sub>16</sub>	6½	8 <sup>7</sup> / <sub>16</sub>	10 <sup>1</sup> / <sub>8</sub>	10 <sup>1</sup> / <sub>8</sub>	13 <sup>1</sup> / <sub>16</sub>	13 <sup>1</sup> / <sub>16</sub>

### Mark 9 LB

Hub size	½"	¾"	1"	1¼"	1½"	2"	2½"	3"	3½"	4"
a	4 <sup>19</sup> / <sub>32</sub>	5¼	6 <sup>3</sup> / <sub>32</sub>	7 <sup>3</sup> / <sub>32</sub>	7 <sup>25</sup> / <sub>32</sub>	10 <sup>3</sup> / <sub>32</sub>	13 <sup>15</sup> / <sub>16</sub>	13 <sup>15</sup> / <sub>16</sub>	16 <sup>1</sup> / <sub>8</sub>	16 <sup>1</sup> / <sub>8</sub>
b	2 <sup>7</sup> / <sub>8</sub>	2 <sup>15</sup> / <sub>32</sub>	2 <sup>13</sup> / <sub>16</sub>	3 <sup>5</sup> / <sub>8</sub>	3 <sup>7</sup> / <sub>8</sub>	4 <sup>19</sup> / <sub>32</sub>	6 <sup>1</sup> / <sub>8</sub>	6 <sup>1</sup> / <sub>2</sub>	7 <sup>9</sup> / <sub>16</sub>	7 <sup>9</sup> / <sub>16</sub>
c	1 <sup>3</sup> / <sub>8</sub>	1 <sup>15</sup> / <sub>32</sub>	1 <sup>3</sup> / <sub>4</sub>	2 <sup>3</sup> / <sub>16</sub>	2 <sup>1</sup> / <sub>2</sub>	3 <sup>3</sup> / <sub>32</sub>	5	5	6¼	6¼
d	1 <sup>1</sup> / <sub>16</sub>	1 <sup>9</sup> / <sub>32</sub>	1 <sup>1</sup> / <sub>16</sub>	1 <sup>7</sup> / <sub>8</sub>	2 <sup>1</sup> / <sub>16</sub>	2 <sup>23</sup> / <sub>32</sub>	4¼	4¼	5 <sup>1</sup> / <sub>16</sub>	5 <sup>1</sup> / <sub>16</sub>
e	3 <sup>9</sup> / <sub>32</sub>	3 <sup>27</sup> / <sub>32</sub>	4 <sup>9</sup> / <sub>16</sub>	5 <sup>3</sup> / <sub>16</sub>	5 <sup>1</sup> / <sub>8</sub>	8 <sup>3</sup> / <sub>32</sub>	10 <sup>1</sup> / <sub>8</sub>	10 <sup>1</sup> / <sub>8</sub>	13 <sup>1</sup> / <sub>16</sub>	13 <sup>1</sup> / <sub>16</sub>

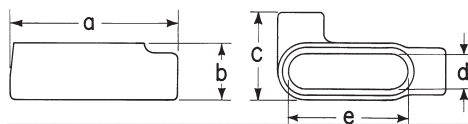

LL shape

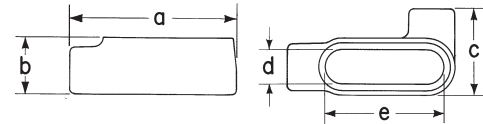

LR shape

### Form 7 LL & LR

Hub size	½"	¾"	1"	1¼"	1½"	2"	2½"	3"	3½"	4"
a	4 <sup>9</sup> / <sub>16</sub>	5 <sup>3</sup> / <sub>16</sub>	6	6½	7 <sup>1</sup> / <sub>8</sub>	8 <sup>1</sup> / <sub>8</sub>	10½	10½	12 <sup>11</sup> / <sub>16</sub>	12 <sup>11</sup> / <sub>16</sub>
b	1 <sup>3</sup> / <sub>8</sub>	1 <sup>3</sup> / <sub>16</sub>	1 <sup>7</sup> / <sub>8</sub>	2 <sup>1</sup> / <sub>16</sub>	2 <sup>1</sup> / <sub>16</sub>	3 <sup>1</sup> / <sub>8</sub>	3 <sup>3</sup> / <sub>8</sub>	4 <sup>7</sup> / <sub>8</sub>	4 <sup>7</sup> / <sub>8</sub>	5 <sup>1</sup> / <sub>8</sub>
c	2¼	2 <sup>1</sup> / <sub>16</sub>	2 <sup>3</sup> / <sub>4</sub>	3 <sup>5</sup> / <sub>16</sub>	3 <sup>1</sup> / <sub>16</sub>	4 <sup>1</sup> / <sub>8</sub>	5¼	5¼	6 <sup>15</sup> / <sub>16</sub>	6 <sup>15</sup> / <sub>16</sub>
d	1 <sup>5</sup> / <sub>16</sub>	1 <sup>1</sup> / <sub>8</sub>	1 <sup>3</sup> / <sub>8</sub>	1 <sup>3</sup> / <sub>4</sub>	1 <sup>15</sup> / <sub>16</sub>	2 <sup>1</sup> / <sub>16</sub>	3 <sup>3</sup> / <sub>16</sub>	3 <sup>3</sup> / <sub>16</sub>	4½	4½
e	3 <sup>3</sup> / <sub>16</sub>	3 <sup>15</sup> / <sub>16</sub>	4½	5	5 <sup>1</sup> / <sub>16</sub>	6 <sup>7</sup> / <sub>8</sub>	8 <sup>1</sup> / <sub>8</sub>	8 <sup>1</sup> / <sub>8</sub>	10¼	10¼

### Form 8 LL & LR

Hub size	½"	¾"	1"	1¼"	1½"	2"	2½"	3"
a	4 <sup>15</sup> / <sub>16</sub>	5 <sup>3</sup> / <sub>16</sub>	6 <sup>15</sup> / <sub>32</sub>	7 <sup>17</sup> / <sub>32</sub>	9 <sup>1</sup> / <sub>8</sub>	11	13 <sup>15</sup> / <sub>16</sub>	13 <sup>15</sup> / <sub>16</sub>
b	1 <sup>1</sup> / <sub>16</sub>	1 <sup>11</sup> / <sub>16</sub>	1 <sup>15</sup> / <sub>16</sub>	2 <sup>1</sup> / <sub>8</sub>	2 <sup>23</sup> / <sub>32</sub>	3 <sup>1</sup> / <sub>16</sub>	4 <sup>1</sup> / <sub>16</sub>	4 <sup>13</sup> / <sub>16</sub>
c	2 <sup>2</sup> / <sub>32</sub>	2 <sup>3</sup> / <sub>16</sub>	2 <sup>5</sup> / <sub>8</sub>	3 <sup>3</sup> / <sub>16</sub>	4	5	6 <sup>11</sup> / <sub>16</sub>	6 <sup>11</sup> / <sub>16</sub>
d	1	1 <sup>3</sup> / <sub>16</sub>	1 <sup>3</sup> / <sub>8</sub>	1 <sup>3</sup> / <sub>4</sub>	2 <sup>1</sup> / <sub>8</sub>	3	4¼	4¼
e	3 <sup>3</sup> / <sub>16</sub>	3 <sup>15</sup> / <sub>16</sub>	4 <sup>9</sup> / <sub>16</sub>	5 <sup>5</sup> / <sub>16</sub>	6½	8 <sup>7</sup> / <sub>16</sub>	10 <sup>1</sup> / <sub>8</sub>	10 <sup>1</sup> / <sub>8</sub>

### Mark 9 LL & LR

Hub size	½"	¾"	1"	1¼"	1½"	2"	2½"	3"	3½"	4"
a	4 <sup>19</sup> / <sub>32</sub>	5¼	6 <sup>3</sup> / <sub>32</sub>	7 <sup>3</sup> / <sub>32</sub>	7 <sup>51</sup> / <sub>64</sub>	10 <sup>3</sup> / <sub>32</sub>	13 <sup>15</sup> / <sub>16</sub>	13 <sup>15</sup> / <sub>16</sub>	16 <sup>1</sup> / <sub>8</sub>	16 <sup>1</sup> / <sub>8</sub>
b	1 <sup>13</sup> / <sub>32</sub>	1 <sup>5</sup> / <sub>8</sub>	1 <sup>7</sup> / <sub>8</sub>	2 <sup>1</sup> / <sub>2</sub>	2 <sup>3</sup> / <sub>16</sub>	3 <sup>1</sup> / <sub>16</sub>	4 <sup>1</sup> / <sub>16</sub>	4 <sup>19</sup> / <sub>16</sub>	5 <sup>11</sup> / <sub>16</sub>	5 <sup>13</sup> / <sub>16</sub>
c	2 <sup>1</sup> / <sub>8</sub>	2 <sup>5</sup> / <sub>16</sub>	2 <sup>1</sup> / <sub>16</sub>	3¼	3½	4 <sup>13</sup> / <sub>64</sub>	6 <sup>11</sup> / <sub>16</sub>	6 <sup>1</sup> / <sub>16</sub>	8 <sup>1</sup> / <sub>8</sub>	8 <sup>1</sup> / <sub>8</sub>
d	1 <sup>1</sup> / <sub>16</sub>	1¼	1 <sup>3</sup> / <sub>8</sub>	1 <sup>3</sup> / <sub>4</sub>	2 <sup>1</sup> / <sub>16</sub>	2 <sup>23</sup> / <sub>32</sub>	4¼	4¼	5 <sup>1</sup> / <sub>16</sub>	5 <sup>1</sup> / <sub>16</sub>
e	3 <sup>9</sup> / <sub>32</sub>	3 <sup>27</sup> / <sub>32</sub>	4 <sup>9</sup> / <sub>16</sub>	5 <sup>3</sup> / <sub>16</sub>	5 <sup>1</sup> / <sub>8</sub>	8 <sup>3</sup> / <sub>32</sub>	10 <sup>1</sup> / <sub>8</sub>	10 <sup>1</sup> / <sub>8</sub>	13 <sup>1</sup> / <sub>16</sub>	13 <sup>1</sup> / <sub>16</sub>

# Condulet conduit bodies – cast iron or aluminum

## Dimensions (in inches):

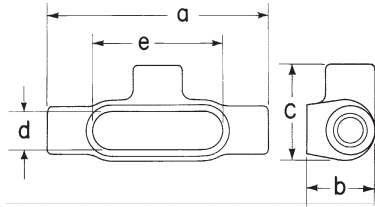

T shape

### Form 7 T

Hub size	a	b	c	d	e
1/2"	5 <sup>5</sup> / <sub>8</sub>	1 <sup>3</sup> / <sub>4</sub>	2 <sup>7</sup> / <sub>16</sub>	1 <sup>5</sup> / <sub>16</sub>	3 <sup>7</sup> / <sub>16</sub>
3/4"	6 <sup>1</sup> / <sub>4</sub>	2	2 <sup>5</sup> / <sub>8</sub>	1 <sup>1</sup> / <sub>8</sub>	3 <sup>13</sup> / <sub>16</sub>
1"	7 <sup>1</sup> / <sub>4</sub>	2 <sup>1</sup> / <sub>4</sub>	3	1 <sup>3</sup> / <sub>8</sub>	4 <sup>1</sup> / <sub>2</sub>
1 1/4"	7 <sup>7</sup> / <sub>16</sub>	2 <sup>5</sup> / <sub>16</sub>	3 <sup>3</sup> / <sub>16</sub>	1 <sup>3</sup> / <sub>4</sub>	5
1 1/2"	8 <sup>3</sup> / <sub>16</sub>	2 <sup>9</sup> / <sub>16</sub>	3 <sup>9</sup> / <sub>16</sub>	1 <sup>15</sup> / <sub>16</sub>	5 <sup>1</sup> / <sub>16</sub>
2"	9 <sup>3</sup> / <sub>16</sub>	3 <sup>3</sup> / <sub>8</sub>	4 <sup>1</sup> / <sub>8</sub>	2 <sup>1</sup> / <sub>16</sub>	6 <sup>3</sup> / <sub>8</sub>
2 1/2"	12	3 <sup>3</sup> / <sub>8</sub>	5 <sup>1</sup> / <sub>4</sub>	3 <sup>7</sup> / <sub>16</sub>	8 <sup>7</sup> / <sub>8</sub>
3"	12 <sup>1</sup> / <sub>16</sub>	4 <sup>3</sup> / <sub>8</sub>	5 <sup>1</sup> / <sub>4</sub>	3 <sup>9</sup> / <sub>16</sub>	8 <sup>7</sup> / <sub>8</sub>
3 1/2"	14 <sup>7</sup> / <sub>16</sub>	4 <sup>7</sup> / <sub>8</sub>	6 <sup>15</sup> / <sub>16</sub>	4 <sup>1</sup> / <sub>2</sub>	10 <sup>1</sup> / <sub>4</sub>
4"	14 <sup>9</sup> / <sub>16</sub>	5 <sup>3</sup> / <sub>8</sub>	6 <sup>15</sup> / <sub>16</sub>	4 <sup>1</sup> / <sub>2</sub>	10 <sup>1</sup> / <sub>4</sub>

### Form 8 T

Hub size	a	b	c	d	e
1/2"	5 <sup>11</sup> / <sub>16</sub>	1 <sup>3</sup> / <sub>4</sub>	2 <sup>5</sup> / <sub>32</sub>	1	3 <sup>5</sup> / <sub>16</sub>
3/4"	6 <sup>9</sup> / <sub>32</sub>	2	2 <sup>5</sup> / <sub>16</sub>	1 <sup>1</sup> / <sub>16</sub>	3 <sup>15</sup> / <sub>16</sub>
1"	7 <sup>5</sup> / <sub>16</sub>	2 <sup>1</sup> / <sub>4</sub>	2 <sup>5</sup> / <sub>8</sub>	1 <sup>3</sup> / <sub>8</sub>	4 <sup>7</sup> / <sub>16</sub>
1 1/4"	8 <sup>1</sup> / <sub>2</sub>	2 <sup>5</sup> / <sub>8</sub>	3 <sup>5</sup> / <sub>32</sub>	1 <sup>3</sup> / <sub>4</sub>	5 <sup>5</sup> / <sub>16</sub>
1 1/2"	10 <sup>3</sup> / <sub>8</sub>	2 <sup>25</sup> / <sub>32</sub>	4	2 <sup>1</sup> / <sub>8</sub>	6 <sup>1</sup> / <sub>2</sub>
2"	12 <sup>1</sup> / <sub>4</sub>	3 <sup>9</sup> / <sub>16</sub>	5	3	8 <sup>7</sup> / <sub>16</sub>
2 1/2"	15 <sup>5</sup> / <sub>8</sub>	4 <sup>1</sup> / <sub>16</sub>	6 <sup>11</sup> / <sub>16</sub>	4 <sup>1</sup> / <sub>4</sub>	10 <sup>7</sup> / <sub>8</sub>
3"	15 <sup>5</sup> / <sub>8</sub>	4 <sup>13</sup> / <sub>16</sub>	6 <sup>11</sup> / <sub>16</sub>	4 <sup>1</sup> / <sub>4</sub>	10 <sup>7</sup> / <sub>8</sub>

### Mark 9 T

Hub size	a	b	c	d	e
1/2"	5	1 <sup>13</sup> / <sub>32</sub>	2 <sup>1</sup> / <sub>8</sub>	1 <sup>1</sup> / <sub>16</sub>	3 <sup>9</sup> / <sub>32</sub>
3/4"	5 <sup>11</sup> / <sub>16</sub>	1 <sup>5</sup> / <sub>8</sub>	2 <sup>5</sup> / <sub>16</sub>	1 <sup>1</sup> / <sub>4</sub>	3 <sup>27</sup> / <sub>32</sub>
1"	6 <sup>19</sup> / <sub>32</sub>	1 <sup>7</sup> / <sub>8</sub>	2 <sup>11</sup> / <sub>16</sub>	1 <sup>3</sup> / <sub>8</sub>	4 <sup>7</sup> / <sub>16</sub>
1 1/4"	7 <sup>5</sup> / <sub>8</sub>	2 <sup>1</sup> / <sub>2</sub>	3 <sup>1</sup> / <sub>4</sub>	1 <sup>7</sup> / <sub>8</sub>	5 <sup>1</sup> / <sub>16</sub>
1 1/2"	8 <sup>11</sup> / <sub>32</sub>	2 <sup>13</sup> / <sub>16</sub>	3 <sup>1</sup> / <sub>2</sub>	2 <sup>1</sup> / <sub>16</sub>	5 <sup>5</sup> / <sub>8</sub>
2"	10 <sup>3</sup> / <sub>8</sub>	3 <sup>1</sup> / <sub>16</sub>	4 <sup>13</sup> / <sub>32</sub>	2 <sup>29</sup> / <sub>32</sub>	8 <sup>7</sup> / <sub>32</sub>
2 1/2"	15 <sup>5</sup> / <sub>8</sub>	4 <sup>7</sup> / <sub>16</sub>	6 <sup>11</sup> / <sub>16</sub>	4 <sup>1</sup> / <sub>4</sub>	10 <sup>7</sup> / <sub>8</sub>
3"	15 <sup>5</sup> / <sub>8</sub>	4 <sup>13</sup> / <sub>16</sub>	6 <sup>11</sup> / <sub>16</sub>	4 <sup>1</sup> / <sub>4</sub>	10 <sup>7</sup> / <sub>8</sub>
3 1/2"	18 <sup>7</sup> / <sub>4</sub>	5 <sup>11</sup> / <sub>16</sub>	8 <sup>7</sup> / <sub>8</sub>	5 <sup>1</sup> / <sub>16</sub>	13 <sup>1</sup> / <sub>16</sub>
4"	18 <sup>7</sup> / <sub>4</sub>	5 <sup>15</sup> / <sub>16</sub>	8 <sup>7</sup> / <sub>8</sub>	5 <sup>1</sup> / <sub>16</sub>	13 <sup>1</sup> / <sub>16</sub>

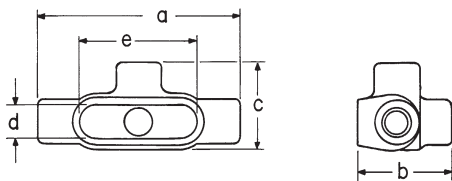

TA shape

### Form 7 TA

Hub size	a	b	c	d	e
1/2"	5 <sup>5</sup> / <sub>8</sub>	2 <sup>5</sup> / <sub>8</sub>	2 <sup>7</sup> / <sub>16</sub>	1 <sup>5</sup> / <sub>16</sub>	3 <sup>7</sup> / <sub>16</sub>
3/4"	6 <sup>1</sup> / <sub>4</sub>	2 <sup>1</sup> / <sub>8</sub>	2 <sup>5</sup> / <sub>8</sub>	1 <sup>1</sup> / <sub>8</sub>	3 <sup>13</sup> / <sub>16</sub>
1"	7 <sup>1</sup> / <sub>4</sub>	3 <sup>1</sup> / <sub>4</sub>	3	1 <sup>3</sup> / <sub>8</sub>	4 <sup>1</sup> / <sub>2</sub>
1 1/4"	7 <sup>7</sup> / <sub>16</sub>	3 <sup>5</sup> / <sub>16</sub>	3 <sup>3</sup> / <sub>16</sub>	1 <sup>3</sup> / <sub>4</sub>	5
1 1/2"	8 <sup>3</sup> / <sub>16</sub>	3 <sup>11</sup> / <sub>16</sub>	3 <sup>9</sup> / <sub>16</sub>	1 <sup>15</sup> / <sub>16</sub>	5 <sup>1</sup> / <sub>16</sub>
2"	9 <sup>3</sup> / <sub>16</sub>	4 <sup>1</sup> / <sub>4</sub>	4 <sup>1</sup> / <sub>8</sub>	2 <sup>1</sup> / <sub>16</sub>	6 <sup>3</sup> / <sub>8</sub>

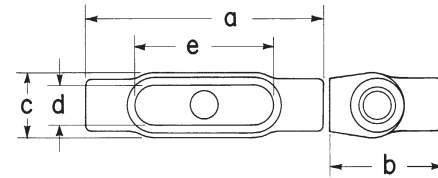

TB shape

### Form 7 TB

Hub size	a	b	c	d	e
1/2"	5 <sup>5</sup> / <sub>8</sub>	2 <sup>5</sup> / <sub>8</sub>	1 <sup>9</sup> / <sub>16</sub>	1 <sup>5</sup> / <sub>16</sub>	3 <sup>7</sup> / <sub>16</sub>
3/4"	6 <sup>1</sup> / <sub>4</sub>	2 <sup>1</sup> / <sub>8</sub>	1 <sup>3</sup> / <sub>4</sub>	1 <sup>1</sup> / <sub>8</sub>	3 <sup>13</sup> / <sub>16</sub>
1"	7 <sup>1</sup> / <sub>4</sub>	3 <sup>1</sup> / <sub>4</sub>	2	1 <sup>3</sup> / <sub>8</sub>	4 <sup>1</sup> / <sub>2</sub>
1 1/4"	7 <sup>7</sup> / <sub>16</sub>	3 <sup>5</sup> / <sub>16</sub>	2 <sup>3</sup> / <sub>16</sub>	1 <sup>3</sup> / <sub>4</sub>	5
1 1/2"	8 <sup>3</sup> / <sub>16</sub>	5	2 <sup>1</sup> / <sub>16</sub>	1 <sup>15</sup> / <sub>16</sub>	5 <sup>1</sup> / <sub>16</sub>
2"	9 <sup>3</sup> / <sub>16</sub>	6 <sup>1</sup> / <sub>8</sub>	3	2 <sup>1</sup> / <sub>16</sub>	6 <sup>3</sup> / <sub>8</sub>

### Form 8 TB

Hub size	a	b	c	d	e
1/2"	5 <sup>11</sup> / <sub>16</sub>	2 <sup>17</sup> / <sub>32</sub>	1 <sup>3</sup> / <sub>8</sub>	1	3 <sup>5</sup> / <sub>16</sub>
3/4"	6 <sup>9</sup> / <sub>32</sub>	2 <sup>3</sup> / <sub>4</sub>	1 <sup>9</sup> / <sub>16</sub>	1 <sup>3</sup> / <sub>16</sub>	3 <sup>15</sup> / <sub>16</sub>
1"	7 <sup>5</sup> / <sub>16</sub>	3 <sup>1</sup> / <sub>8</sub>	1 <sup>3</sup> / <sub>4</sub>	1 <sup>3</sup> / <sub>8</sub>	4 <sup>7</sup> / <sub>16</sub>
1 1/4"	8 <sup>1</sup> / <sub>2</sub>	3 <sup>11</sup> / <sub>32</sub>	2 <sup>3</sup> / <sub>16</sub>	1 <sup>3</sup> / <sub>4</sub>	5 <sup>5</sup> / <sub>16</sub>
1 1/2"	10 <sup>3</sup> / <sub>8</sub>	4 <sup>1</sup> / <sub>32</sub>	2 <sup>1</sup> / <sub>4</sub>	2 <sup>1</sup> / <sub>8</sub>	6 <sup>1</sup> / <sub>2</sub>
2"	12 <sup>1</sup> / <sub>4</sub>	4 <sup>13</sup> / <sub>16</sub>	3 <sup>3</sup> / <sub>4</sub>	3	8 <sup>7</sup> / <sub>16</sub>

### Mark 9 TB

Hub size	a	b	c	d	e
1/2"	5 <sup>11</sup> / <sub>16</sub>	2 <sup>33</sup> / <sub>64</sub>	1 <sup>3</sup> / <sub>8</sub>	1	3 <sup>5</sup> / <sub>16</sub>
3/4"	6 <sup>3</sup> / <sub>16</sub>	2 <sup>1</sup> / <sub>8</sub>	1 <sup>5</sup> / <sub>8</sub>	1 <sup>3</sup> / <sub>16</sub>	3 <sup>15</sup> / <sub>16</sub>
1"	7 <sup>5</sup> / <sub>16</sub>	3 <sup>1</sup> / <sub>8</sub>	1 <sup>3</sup> / <sub>4</sub>	1 <sup>3</sup> / <sub>8</sub>	4 <sup>7</sup> / <sub>16</sub>
1 1/4"	8 <sup>1</sup> / <sub>2</sub>	3 <sup>11</sup> / <sub>32</sub>	2 <sup>3</sup> / <sub>16</sub>	1 <sup>3</sup> / <sub>4</sub>	5 <sup>5</sup> / <sub>16</sub>
1 1/2"	8 <sup>11</sup> / <sub>32</sub>	3 <sup>1</sup> / <sub>8</sub>	2 <sup>1</sup> / <sub>2</sub>	2 <sup>3</sup> / <sub>16</sub>	5 <sup>7</sup> / <sub>8</sub>
2"	10 <sup>7</sup> / <sub>8</sub>	4 <sup>15</sup> / <sub>32</sub>	3 <sup>1</sup> / <sub>32</sub>	2 <sup>13</sup> / <sub>16</sub>	8 <sup>7</sup> / <sub>32</sub>

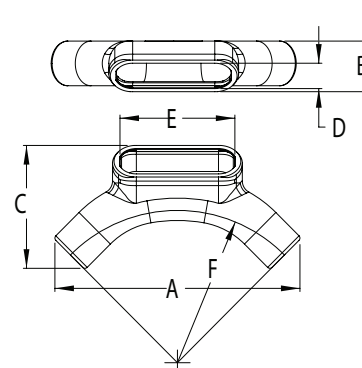

U shape

### Form 7 U

Hub size	A	B	C	D	E	F (bend radius)
1/2"	7 <sup>1</sup> / <sub>8</sub>	1 <sup>1</sup> / <sub>2</sub>	3 <sup>11</sup> / <sub>16</sub>	1 <sup>5</sup> / <sub>16</sub>	3 <sup>7</sup> / <sub>16</sub>	4.4
3/4"	7 <sup>1</sup> / <sub>2</sub>	1 <sup>11</sup> / <sub>16</sub>	3 <sup>7</sup> / <sub>8</sub>	1 <sup>1</sup> / <sub>8</sub>	3 <sup>13</sup> / <sub>16</sub>	4.6
1"	9 <sup>11</sup> / <sub>16</sub>	2	4 <sup>13</sup> / <sub>16</sub>	1 <sup>3</sup> / <sub>8</sub>	4 <sup>1</sup> / <sub>2</sub>	6.0
1 1/4"	12	2 <sup>1</sup> / <sub>2</sub>	5 <sup>15</sup> / <sub>16</sub>	1 <sup>3</sup> / <sub>4</sub>	5	7.4
1 1/2"	15 <sup>5</sup> / <sub>8</sub>	2 <sup>1</sup> / <sub>8</sub>	7 <sup>3</sup> / <sub>16</sub>	1 <sup>15</sup> / <sub>16</sub>	5 <sup>1</sup> / <sub>16</sub>	9.6
2"	17 <sup>5</sup> / <sub>16</sub>	3 <sup>3</sup> / <sub>8</sub>	8 <sup>3</sup> / <sub>8</sub>	2 <sup>1</sup> / <sub>16</sub>	6 <sup>3</sup> / <sub>8</sub>	10.9

# Condulet conduit bodies – cast iron or aluminum

## Dimensions (in inches):

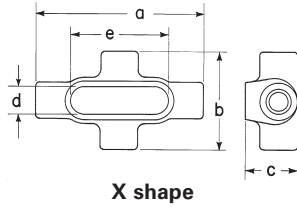

### Form 7 X

Hub size	a	b	c	d	e
1/2"	5 <sup>5</sup> / <sub>8</sub>	3 <sup>5</sup> / <sub>16</sub>	1 <sup>3</sup> / <sub>4</sub>	1 <sup>5</sup> / <sub>16</sub>	3 <sup>3</sup> / <sub>16</sub>
3/4"	6 <sup>1</sup> / <sub>4</sub>	3 <sup>1</sup> / <sub>2</sub>	2	1 <sup>1</sup> / <sub>8</sub>	3 <sup>13</sup> / <sub>16</sub>
1"	7 <sup>1</sup> / <sub>4</sub>	4	2 <sup>1</sup> / <sub>4</sub>	1 <sup>3</sup> / <sub>8</sub>	4 <sup>1</sup> / <sub>2</sub>
1 1/4"	7 <sup>7</sup> / <sub>16</sub>	4 <sup>1</sup> / <sub>8</sub>	2 <sup>5</sup> / <sub>16</sub>	1 <sup>3</sup> / <sub>4</sub>	5
1 1/2"	8 <sup>3</sup> / <sub>16</sub>	4 <sup>5</sup> / <sub>8</sub>	2 <sup>3</sup> / <sub>16</sub>	1 <sup>15</sup> / <sub>16</sub>	5 <sup>1</sup> / <sub>16</sub>
2"	9 <sup>3</sup> / <sub>16</sub>	5 <sup>3</sup> / <sub>16</sub>	3 <sup>1</sup> / <sub>8</sub>	2 <sup>1</sup> / <sub>16</sub>	6 <sup>3</sup> / <sub>8</sub>

### Form 8 X

Hub size	a	b	c	d	e
1/2"	5 <sup>11</sup> / <sub>16</sub>	2 <sup>29</sup> / <sub>32</sub>	1 <sup>3</sup> / <sub>4</sub>	1	3 <sup>7</sup> / <sub>16</sub>
3/4"	6 <sup>9</sup> / <sub>32</sub>	3 <sup>1</sup> / <sub>16</sub>	2	1 <sup>3</sup> / <sub>16</sub>	3 <sup>15</sup> / <sub>16</sub>
1"	7 <sup>3</sup> / <sub>16</sub>	3 <sup>1</sup> / <sub>2</sub>	2 <sup>1</sup> / <sub>4</sub>	1 <sup>3</sup> / <sub>8</sub>	4 <sup>9</sup> / <sub>16</sub>
1 1/4"	8 <sup>1</sup> / <sub>2</sub>	4 <sup>1</sup> / <sub>8</sub>	2 <sup>5</sup> / <sub>8</sub>	1 <sup>3</sup> / <sub>4</sub>	5 <sup>5</sup> / <sub>16</sub>
1 1/2"	10 <sup>3</sup> / <sub>8</sub>	5 <sup>1</sup> / <sub>4</sub>	2 <sup>15</sup> / <sub>32</sub>	2 <sup>1</sup> / <sub>8</sub>	6 <sup>1</sup> / <sub>2</sub>
2"	12 <sup>1</sup> / <sub>4</sub>	6 <sup>1</sup> / <sub>4</sub>	3 <sup>3</sup> / <sub>16</sub>	3	8 <sup>3</sup> / <sub>16</sub>

### Mark 9 X

Hub size	a	b	c	d	e
1/2"	5 <sup>11</sup> / <sub>16</sub>	2 <sup>57</sup> / <sub>64</sub>	1 <sup>3</sup> / <sub>4</sub>	1	3 <sup>5</sup> / <sub>16</sub>
3/4"	6 <sup>9</sup> / <sub>16</sub>	3 <sup>1</sup> / <sub>4</sub>	2	1 <sup>3</sup> / <sub>16</sub>	3 <sup>15</sup> / <sub>16</sub>
1"	7 <sup>5</sup> / <sub>16</sub>	3 <sup>1</sup> / <sub>2</sub>	2 <sup>1</sup> / <sub>4</sub>	1 <sup>3</sup> / <sub>8</sub>	4 <sup>9</sup> / <sub>16</sub>