

NEC 6x8x C, LB, UB, LL, LR and T Mogul Conduit Outlet Bodies, Covers and Gaskets

For use with Threaded Rigid Metal Conduit and IMC. Complete with Assembled Cover and Neoprene Gasket.

NEC/CEC — Suitable for use in the following
Hazardous Locations:
Class I, Division 2 per NEC 501.10(B)(4)

Applications

- Larger body size facilitates pulling of large and heavy conductors. Specially designed raised cast covers provide additional wiring area.
- Mogul Unilets™ for pulling straight, 45° or 90° angle turns and/or making taps and splices.

Features

- Exclusive built-in rollers facilitate cable pulling. Available on NEC 6x8x Series Moguls (C, LB and UB) in sizes 1-1/4" and up.
- Smooth, rounded integral bushing in each hub protects conductor insulation.
- Accurately tapped, tapered threads for tight, rigid joints and ground continuity.
- Covers have captive stainless steel screws to speed installation, prevent "freezing" of screws.
- LB and UB Moguls
 - Length Requirement: distance between centerline of each hub bushing (conduit stop) exceeds six times the trade diameter of the conduit per NEC 314.28(A)(2).
 - Bending Space Requirement: these moguls also meet the NEC 314.28(A)(2) Exception requirement spelled out in NEC 312.6(A) Table.
- C Moguls
 - Length Requirement: distance between centerline of each hub bushing (conduit stop) exceeds eight times the trade diameter of the conduit per NEC 314.28(A)(1).
 - Bending Space Requirement: not applicable.
- LL and LR Moguls
 - Like LB moguls, these moguls have an end hub.
 - The second hub is in the side (LL left and LR right) instead of the back.
- T Moguls
 - These are like "C" moguls (1" thru 4"), except with an additional middle side hub.
 - Distance between the centerline of each "C" hub conduit stop exceeds eight times the trade diameter of the conduit per NEC 314.28(A)(1). ①

Standard Materials

- Bodies and covers: malleable iron or copperfree (4/10 of 1% max.) aluminum
- Gaskets: neoprene
- Screws: stainless steel

Standard Finishes

- Malleable iron bodies and covers: triple-coat — (1) zinc electroplate, (2) chromate and (3) epoxy powder coat
- Aluminum bodies and covers: epoxy powder coat

NEC/CEC Certifications and Compliances

- UL Standard: 514B
- UL Listed: E2527
- CSA Standard: C22.2 No. 18.3
- CSA Certified: 065183
- NEMA Standard: FB-1



C Type NEC 8x



LB Type 1" – 2"
NEC 6x



LB Type 2-1/2" – 4"
NEC 6x



UB Type NEC 6x



LR Type NEC 6x



LL Type NEC 6x



T Type NEC 8x

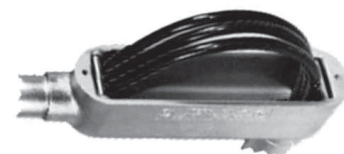







Rollers make cable-pulling easier, eliminate insulation damage

① If less than maximum conductors permitted by NEC are used, smaller wires may be used additionally through "LL", "LR" or "T" hubs. If large conductors are required to be bent in "LL", "LR" or "T" direction, order junction boxes instead. See Enclosures and Junction Boxes.

NEC 6x8x C, LB, UB, LL, LR and T Mogul Conduit Outlet Bodies, Covers and Gaskets

For use with Threaded Rigid Metal Conduit and IMC. Complete with Assembled Cover and Neoprene Gasket.

NEC/CEC — Suitable for use in the following
Hazardous Locations:
Class I, Division 2 per NEC 501.10(B)(4)

Type	Hub Size (Inches)	Max. Wire Fill	Body, Cover and Gasket		Gasket Only	Cover and Gasket		
			Malleable Iron	Aluminum		Malleable Iron	Aluminum	
C NEC 8X								
 1" - 2"	1	(3) # 2	BC100-M	BC100-A	BG100	BKG100-M	BKG100-A	
	1-1/4	(3) # 1/0	BC125-M ①	BC125-A ①	BGC125	BKGC125-M	BKGC125-A	
	1-1/2	(3) # 3/0	BC150-M ①	BC150-A ①	BG150	BKG150-M	BKG150-A	
	2	(3) 300	BC200-M ①	BC200-A ①	BGC200	BKGC200-M	BKGC200-A	
 2-1/2" - 4"	2-1/2	(3) 400	BC250-M ①	BC250-A ①	BGC250	BKGC250-M	BKGC250-A	
	3	(3) 700	BC300-M ①	BC300-A ①	BGC300	BKGC300-M	BKGC300-A	
	3-1/2	(3) 900	BC350-M ①	BC350-A ①	BGC350	BKGC350-M	BKGC350-A	
	4	(3) 1000	BC400-M ①	BC400-A ①	BGC400	BKGC400-M	BKGC400-A	
LB NEC 6X								
 1" - 2"	1	(3) # 2	BLB100-M	BLB100-A	BG100	BKG100-M	BKG100-A	
	1-1/4	(3) # 1/0	BLB125-M ①	BLB125-A ①	BGL125	BKGL125-M	BKGL125-A	
	1-1/2	(3) # 3/0	BLB150-M ①	BLB150-A ①	BG150	BKG150-M	BKG150-A	
	2	(3) 300	BLB200-M ①	BLB200-A ①	BGL200	BKGL200-M	BKGL200-A	
 2-1/2" - 4"	2-1/2	(3) 400	BLB250-M ①	BLB250-A ①	BGL250	BKGL250-M	BKGL250-A	
	3	(3) 700	BLB300-M ①	BLB300-A ①	BGL300	BKGL300-M	BKGL300-A	
	3-1/2	(3) 900	BLB350-M ①	BLB350-A ①	BGL350	BKGL350-M	BKGL350-A	
	4	(3) 1000	BLB400-M ①	BLB400-A ①	BGL400	BKGL400-M	BKGL400-A	
UB NEC 6X								
 1" - 2"	1	(3) # 2	BUB100-M	BUB100-A	BG100	BKG100-M	BKG100-A	
	1-1/4	(3) # 1/0	BUB125-M ①	BUB125-A ①	BGL125	BKGL125-M	BKGL125-A	
	1-1/2	(3) # 3/0	BUB150-M ①	BUB150-A ①	BG150	BKG150-M	BKG150-A	
	2	(3) 300	BUB200-M ①	BUB200-A ①	BGL200	BKGL200-M	BKGL200-A	
 2-1/2" - 4"	2-1/2	(3) 400	BUB250-M ①	BUB250-A ①	BGL250	BKGC250-M	BKGC250-A	
	3	(3) 700	BUB300-M ①	BUB300-A ①	BGL300	BKGU300-M	BKGU300-A	
	3-1/2	(3) 900	BUB350-M ①	BUB350-A ①	BGL350	BKGC350-M	BKGC350-A	
	4	(3) 1000	BUB400-M ①	BUB400-A ①	BGL400	BKGU400-M	BKGU400-A	

① Furnished with rollers for easier cable pulling.

NEC 6x8x C, LB, UB, LL, LR and T Mogul Conduit Outlet Bodies, Covers and Gaskets

For use with Threaded Rigid Metal Conduit and IMC. Complete with Assembled Cover and Neoprene Gasket.

NEC/CEC — Suitable for use in the following Hazardous Locations:
Class I, Division 2 per NEC 501.10(B)(4)

Applicable NEC References for C, LB and UB Moguls

- Straight Pull Length Requirements:** NEC 314.28(A)(2)— C Moguls "... shall not be less than eight times the trade diameter of the largest raceway." (See table at right.)
- Angle or U Pull Length Requirements:** NEC 314.28(A)(2)— LB, UB Moguls "The distance between each raceway entry inside the box and the opposite wall of the box shall not be less than six times the trade diameter of the largest raceway." (See next page.)
- Bending-Space Requirements:** NEC 314.28(A)(2). Exception 312.6(A) Table— LB, UB Moguls "Where a conduit or cable entry is in the wall of a box or conduit body opposite to a removable cover." (See dim. "A", table right)
- Length and Bending Space Requirements:**

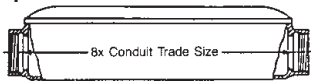

C Mogul— 1" thru 4"

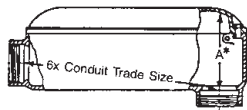

LB Mogul— 1" thru 2"

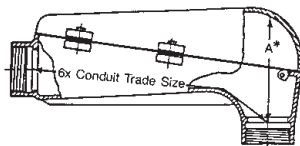

LB Mogul— 2-1/2" thru 4"

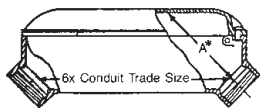

UB Mogul— 1" thru 4"

BENDING SPACE EXAMPLE: LB with 3" hubs (Cat. No. BLB300-M) using 500 MCM wire with four conductors.

Table on next page shows that, in this example, NEC requires a bending space of 6" and that the Appleton™ 3" LB provides a bending space of 8".

C Moguls — Straight Pulls: Maximum Number of Conductors, Minimum Lengths

Wire Size ①	Length Requirements (Conduit Stop to Conduit Stop)			Maximum Number of Conductors per NEC ②	Length Requirements (Conduit Stop to Conduit Stop)		
	Maximum Number of Conductors per NEC ②	Per NEC ③	Appleton™		Per NEC ③	Appleton™	
1" Hubs – BC100-M and BC100-A							
4	4	8"	8"	7	10"	10"	
3	3	8"	8"	6	10"	10"	
2	3	8"	8"	5	10"	10"	
1	-	-	-	3	10"	10"	
0	-	-	-	3	10"	10"	
1-1/2" Hubs – BC150-M and BC150-A				2" Hubs – BC200-M and BC200-A			
4	9	12"	12"	16	16"	16"	
3	8	12"	12"	13	16"	16"	
2	7	12"	12"	11	16"	16"	
1	5	12"	12"	8	16"	16"	
0	4	12"	12"	7	16"	16"	
00	3	12"	12"	6	16"	16"	
000	3	12"	12"	5	16"	16"	
0000	-	-	-	4	16"	16"	
250	-	-	-	3	16"	16"	
300	-	-	-	3	16"	16"	
2-1/2" Hubs – BC250-M and BC250-A				3" Hubs – BC300-M and BC300-A			
4	22	20"	20"	35	24"	24"	
3	19	20"	20"	29	24"	24"	
2	16	20"	20"	25	24"	24"	
1	12	20"	20"	18	24"	24"	
0	10	20"	20"	15	24"	24"	
00	8	20"	20"	13	24"	24"	
000	7	20"	20"	11	24"	24"	
0000	6	20"	20"	9	24"	24"	
250	4	20"	20"	7	24"	24"	
300	4	20"	20"	6	24"	24"	
350	3	15"	20"	5	24"	24"	
400	3	15"	20"	5	24"	24"	
500	-	-	-	4	24"	24"	
600	-	-	-	3	24"	24"	
700	-	-	-	3	24"	24"	
3-1/2" Hubs – BC350-M and BC400-A				4" Hubs – BC400-M and BC400-A			
4	47	28"	28"	60	32"	32"	
3	39	28"	28"	51	32"	32"	
2	33	28"	28"	43	32"	32"	
1	25	28"	28"	32	32"	32"	
0	21	28"	28"	27	32"	32"	
00	17	28"	28"	32	32"	32"	
000	14	28"	28"	18	32"	32"	
0000	12	28"	28"	15	32"	32"	
250	10	28"	28"	12	32"	32"	
300	8	28"	28"	11	32"	32"	
350	7	28"	28"	9	32"	32"	
400	6	28"	28"	8	32"	32"	
500	5	28"	28"	7	32"	32"	
600	4	28"	28"	5	32"	32"	
700	4	28"	28"	5	32"	32"	
750	3	28"	28"	4	32"	32"	
800	3	28"	28"	4	32"	32"	
900	3	28"	28"	4	32"	32"	
1000	-	-	-	3	32"	32"	

① NEC 314.28(A), 314(A)(2). Limited to minimum #4 wire.

② NEC Chapter 9, Table 3B.

③ NEC 370.28(A)(1). This is 8 times conduit trade size.

* Dimension "A" is bending space.

NEC 6x8x C, LB, UB, LL, LR and T Mogul Conduit Outlet Bodies, Covers and Gaskets

For use with Threaded Rigid Metal Conduit and IMC. Complete with Assembled Cover and Neoprene Gasket.

NEC/CEC — Suitable for use in the following
 Hazardous Locations:
 Class I, Division 2 per NEC 501.10(B)(4)

LB and UB Moguls- Angle or U Pulls: Max. No. Conductors, Min. Lengths, Min. Bending Spaces

Wire Size ①	Maximum Number of Conductors per NEC ②	Length Requirements (Conduit Stop to Conduit Stop)		(A) Bending Space Requirements		Maximum Number of Conductors per NEC ②	Length Requirements (Conduit Stop to Conduit Stop)		(A) Bending Space Requirements		
		Per NEC ③	Appleton™	Per NEC ③	Appleton™		Per NEC ③	Appleton™			
1" Hubs – BLB100-M, BLB100-A, BUB100-M and BUB100-A						1-1/4" Hubs – BLB125-M, BLB125-A, BUB125-M and BUB200-A					
4	4	6"	6"	2"	2-1/2"	7	7-1/2"	7-1/2"	2"	3-1/2"	
3	3	6"	6"	2"	2-1/2"	6	7-1/2"	7-1/2"	2"	3-1/2"	
2	3	6"	6"	2-1/2"	2-1/2"	5	7-1/2"	7-1/2"	2-1/2"	3-1/2"	
1	-	-	-	-	-	3	7-1/2"	7-1/2"	3"	3-1/2"	
0	-	-	-	-	-	3	7-1/2"	7-1/2"	3-1/2"	3-1/2"	
1-1/2" Hubs – BLB150-M, BLB150-A, BUB150-M and BUB150-A						2" Hubs – BLB200-M, BLB200-A, BUB200-M and BUB200-A					
4	9	9"	9"	2"	4"	16	12"	12"	2"	5"	
3	8	9"	9"	2"	4"	13	12"	12"	2"	5"	
2	7	9"	9"	2-1/2"	4"	11	12"	12"	2-1/2"	5"	
1	5	9"	9"	3"	4"	8	12"	12"	3"	5"	
0	4	9"	9"	3-1/2"	4"	7	12"	12"	3-1/2"	5"	
00	3	9"	9"	3-1/2"	4"	6	12"	12"	3-1/2"	5"	
000	3	9"	9"	4"	4"	5	12"	12"	4"	5"	
0000	-	-	-	-	-	4	12"	12"	4"	5"	
250	-	-	-	-	-	3	12"	12"	4-1/2"	5"	
300	-	-	-	-	-	3	12"	12"	5"	5"	
2-1/2" Hubs – BLB250-M, BLB250-A, BUB250-M and BUB250-A						3" Hubs – BLB300-M, BLB300-A, BUB300-M and BUB300-A					
4	22	15"	15"	2"	6"	35	18"	18"	2"	8"	
3	19	15"	15"	2"	6"	29	18"	18"	2"	8"	
2	16	15"	15"	2-1/2"	6"	25	18"	18"	2-1/2"	8"	
1	12	15"	15"	3"	6"	18	18"	18"	3"	8"	
0	10	15"	15"	3-1/2"	6"	15	18"	18"	3-1/2"	8"	
00	8	15"	15"	3-1/2"	6"	13	18"	18"	3-1/2"	8"	
000	7	15"	15"	4"	6"	11	18"	18"	4"	8"	
0000	6	15"	15"	4"	6"	9	18"	18"	4"	8"	
250	4	15"	15"	4-1/2"	6"	7	18"	18"	4-1/2"	8"	
300	4	15"	15"	5"	6"	6	18"	18"	5"	8"	
350	3	15"	15"	5"	6"	5	18"	18"	5"	8"	
400	3	15"	15"	6"	6"	5	18"	18"	6"	8"	
500	-	-	-	-	-	4	18"	18"	6"	8"	
600	-	-	-	-	-	3	18"	18"	8"	8"	
700	-	-	-	-	-	3	18"	18"	8"	8"	
3-1/2" Hubs – BLB350-M, BLB350-A, BUB350-M and BUB350-A						4" Hubs – BLB400-M, BLB400-A, BUB400-M and BUB400-A					
4	47	21"	21"	2"	8"	60	24"	24"	2"	10"	
3	39	21"	21"	2"	8"	51	24"	24"	2"	10"	
2	33	21"	21"	2-1/2"	8"	43	24"	24"	2-1/2"	10"	
1	25	21"	21"	3"	8"	32	24"	24"	3"	10"	
0	21	21"	21"	3-1/2"	8"	27	24"	24"	3-1/2"	10"	
00	17	21"	21"	3-1/2"	8"	22	24"	24"	3-1/2"	10"	
000	14	21"	21"	4"	8"	18	24"	24"	4"	10"	
0000	12	21"	21"	4"	8"	15	24"	24"	4"	10"	
250	10	21"	21"	4-1/2"	8"	12	24"	24"	4-1/2"	10"	
300	8	21"	21"	5"	8"	11	24"	24"	5"	10"	
350	7	21"	21"	5"	8"	9	24"	24"	5"	10"	
400	6	21"	21"	6"	8"	8	24"	24"	6"	10"	
500	5	21"	21"	6"	8"	7	24"	24"	6"	10"	
600	4	21"	21"	8"	8"	5	24"	24"	8"	10"	
700	4	21"	21"	8"	8"	5	24"	24"	8"	10"	
750	3	21"	21"	8"	8"	4	24"	24"	8"	10"	
800	3	21"	21"	8"	8"	4	24"	24"	8"	10"	
900	3	21"	21"	8"	8"	4	24"	24"	8"	10"	
1000	-	-	-	-	-	3	24"	24"	10"	10"	

① NEC 314.28(A). Limited to minimum #4 wire.

② NEC Chapter 9, Table 3B.

③ NEC 314.28(A)(2) This is 6 times conduit trade size.

④ NEC 314.28(A)(2) Exception (312.6(B) Table). This is distance "A" bending space illustrated on preceding page.

NEC 6x8x C, LB, UB, LL, LR and T Mogul Conduit Outlet Bodies, Covers and Gaskets

For use with Threaded Rigid Metal Conduit and IMC. Complete with Assembled Cover and Neoprene Gasket.

NEC/CEC — Suitable for use in the following
Hazardous Locations:
Class I, Division 2 per NEC 501.10(B)(4)

Dimensions in Millimeters (Inches)

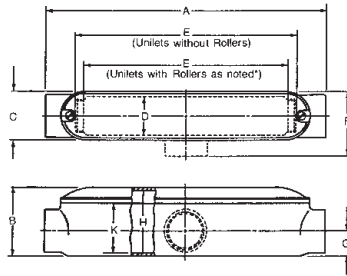

Types C, T

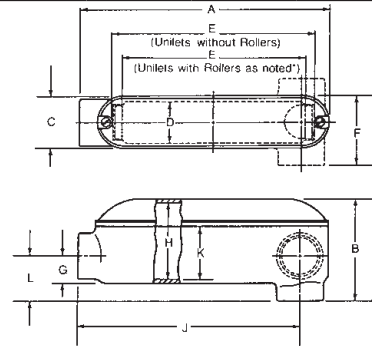

Types LB, LL, LR

Type Mogul	Hub Trade Size (Inches)	Dimensions in Millimeters (Inches)										Number of Cover Holes
		A	B	C	D	E	F	G	H	J	K	
C	1	249.2 (9.81)	69.9 (2.75)	60.5 (2.38)	47.8 (1.88)	168.4 (6.63)	—	23.9 (0.94)	62.0 (2.44)	—	47.8 (1.88)	2
	1-1/4 ①	304.8 (12.00)	84.1 (3.31)	60.5 (2.38)	47.8 (1.88)	195.3 (7.69)	—	29.5 (1.16)	76.2 (3.00)	—	55.6 (2.19)	2
	1-1/2 ①	354.1 (13.94)	95.3 (3.75)	79.5 (3.13)	63.5 (2.50)	236.5 (9.31)	—	35.1 (1.38)	85.9 (3.38)	—	65.0 (2.56)	2
	2 ①	455.7 (17.94)	112.8 (4.44)	79.5 (3.13)	63.5 (2.50)	330.2 (13.00)	—	41.4 (1.63)	101.6 (4.00)	—	80.8 (3.18)	2
	2-1/2 ①	590.6 (23.25)	130.3 (5.13)	117.6 (4.63)	95.3 (3.75)	444.5 (17.50)	—	46.0 (1.81)	117.6 (4.63)	—	92.2 (3.63)	4
	3 ①	682.8 (26.88)	150.9 (5.94)	117.6 (4.63)	92.2 (3.63)	533.4 (21.00)	—	54.9 (2.16)	138.2 (5.44)	—	111.3 (4.38)	4
	3-1/2 ①	797.1 (31.38)	182.6 (7.19)	143.0 (5.63)	114.3 (4.50)	633.5 (24.94)	—	63.5 (2.50)	169.9 (6.69)	—	124.0 (4.88)	4
	4 ①	898.7 (35.38)	192.0 (7.56)	143.0 (5.63)	114.3 (4.50)	735.1 (28.94)	—	69.9 (2.75)	179.3 (7.06)	—	133.4 (5.25)	4
T	1	249.2 (9.81)	69.9 (2.75)	60.5 (2.38)	47.8 (1.88)	168.4 (6.63)	82.6 (3.25)	23.9 (0.94)	62.0 (2.44)	—	47.8 (1.88)	2
	1-1/4	304.8 (12.00)	84.1 (3.31)	60.5 (2.38)	47.8 (1.88)	217.4 (8.56)	85.9 (3.38)	29.5 (1.16)	76.2 (3.00)	—	55.6 (2.19)	2
	1-1/2	354.1 (13.94)	95.3 (3.75)	79.5 (3.13)	63.5 (2.50)	263.7 (10.38)	104.9 (4.13)	35.1 (1.38)	85.9 (3.38)	—	65.0 (2.56)	2
	2	455.7 (17.94)	112.8 (4.44)	79.5 (3.13)	63.5 (2.50)	358.9 (14.13)	104.9 (4.13)	41.4 (1.63)	101.6 (4.00)	—	80.8 (3.18)	2
	2-1/2	590.6 (23.25)	130.3 (5.13)	117.6 (4.63)	95.3 (3.75)	474.7 (18.69)	152.4 (6.00)	46.0 (1.81)	117.6 (4.63)	—	92.2 (3.63)	4
	3	682.8 (26.88)	150.9 (5.94)	117.6 (4.63)	92.2 (3.63)	563.6 (22.19)	152.4 (6.00)	54.9 (2.16)	138.2 (5.44)	—	111.3 (4.38)	4
	3-1/2	797.1 (31.38)	182.6 (7.19)	143.0 (5.63)	114.3 (4.50)	665.2 (26.19)	184.2 (7.25)	63.5 (2.50)	169.9 (6.69)	—	124.0 (4.88)	4
	4	898.7 (35.38)	192.0 (7.56)	143.0 (5.63)	114.3 (4.50)	766.8 (30.19)	184.2 (7.25)	69.9 (2.75)	179.3 (7.06)	—	133.4 (5.25)	4
LL, LR	1	227.1 (8.94)	69.9 (2.75)	60.5 (2.38)	47.8 (1.88)	168.4 (6.63)	82.6 (3.25)	23.9 (0.94)	62.0 (2.44)	200.2 (7.88)	47.8 (1.88)	2
	1-1/4	246.1 (9.69)	84.1 (3.31)	60.5 (2.38)	47.8 (1.88)	184.2 (7.25)	85.9 (3.38)	29.5 (1.16)	76.2 (3.00)	215.9 (8.50)	55.6 (2.19)	2
	1-1/2	330.2 (13.00)	95.3 (3.75)	79.5 (3.13)	63.5 (2.50)	263.7 (10.38)	104.9 (4.13)	35.1 (1.38)	85.9 (3.38)	295.4 (11.63)	65.0 (2.56)	2
	2	371.6 (14.63)	127.0 (5.00)	79.5 (3.13)	63.5 (2.50)	300.0 (11.81)	104.9 (4.13)	41.4 (1.63)	115.8 (4.56)	328.7 (12.94)	87.4 (3.44)	2

① Furnished with rollers for easier cable pulling.

NEC 6x8x C, LB, UB, LL, LR and T Mogul Conduit Outlet Bodies, Covers and Gaskets

For use with Threaded Rigid Metal Conduit and IMC. Complete with Assembled Cover and Neoprene Gasket.

NEC/CEC — Suitable for use in the following
 Hazardous Locations:
 Class I, Division 2 per NEC 501.10(B)(4)

Dimensions in Millimeters (Inches)

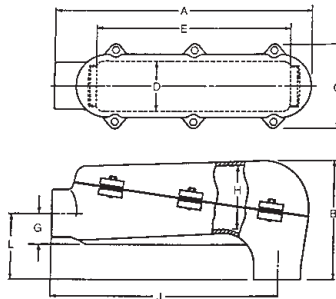

Type LB – 2-1/2" thru 4"

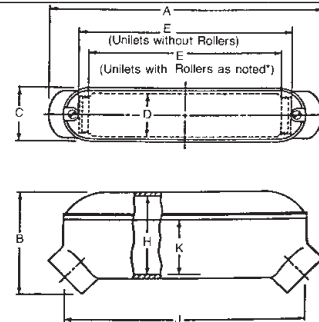

Type UB

Type Mogul	Hub Trade Size (Inches)	Dimensions in Millimeters (Inches)										Number of Cover Holes
		A	B	C	D	E	G	H	J	K	L	
LB	1	227.1 (8.94)	92.2 (3.63)	60.5 (2.38)	47.8 (1.88)	168.4 (6.63)	23.9 (0.94)	62.0 (2.44)	200.2 (7.88)	47.8 (1.88)	47.8 (1.88)	2
	1-1/4 ①	246.1 (9.69)	120.7 (4.75)	60.5 (2.38)	47.8 (1.88)	160.3 (6.31)	29.5 (1.16)	87.4 (3.44)	215.9 (8.50)	66.8 (2.63)	54.9 (2.16)	2
	1-1/2 ①	330.2 (13.00)	133.4 (5.25)	79.5 (3.13)	63.5 (2.50)	236.5 (9.31)	35.1 (1.38)	100.1 (3.94)	295.4 (11.63)	77.7 (3.06)	60.5 (2.38)	2
	2 ①	371.6 (14.63)	160.3 (6.31)	79.5 (3.13)	63.5 (2.50)	273.1 (10.75)	41.4 (1.63)	124.0 (4.88)	328.7 (12.94)	87.4 (3.44)	68.3 (2.69)	2
	2-1/2 ①	454.2 (17.88)	203.2 (8.00)	149.4 (5.88)	88.9 (3.50)	349.3 (13.75)	54.1 (2.13)	104.9 (4.13)	401.6 (15.81)	-	115.8 (4.56)	6
	3 ①	534.9 (21.06)	254.0 (10.00)	149.4 (5.88)	88.9 (3.50)	431.8 (17.00)	63.5 (2.50)	130.3 (5.13)	469.9 (18.50)	-	136.7 (5.38)	6
	3-1/2 ①	617.5 (24.31)	260.4 (10.25)	177.8 (7.00)	117.6 (4.63)	505.0 (19.88)	76.2 (3.00)	120.7 (4.75)	543.1 (21.38)	-	168.4 (6.63)	6
	4 ①	698.5 (27.50)	317.5 (12.50)	177.8 (7.00)	117.6 (4.63)	584.2 (23.00)	82.6 (3.25)	162.1 (6.38)	619.3 (24.38)	-	177.8 (7.00)	6
UB	1	244.6 (9.63)	88.9 (3.50)	60.5 (2.38)	47.8 (1.88)	168.4 (6.63)	-	62.0 (2.44)	214.4 (8.44)	47.8 (1.88)	-	2
	1-1/4 ①	260.4 (10.25)	104.9 (4.13)	60.5 (2.38)	47.8 (1.88)	160.3 (6.31)	-	76.2 (3.00)	227.1 (8.94)	55.6 (2.19)	-	2
	1-1/2 ①	347.7 (13.69)	117.6 (4.63)	79.5 (3.13)	63.5 (2.50)	236.5 (9.31)	-	85.9 (3.38)	309.6 (12.19)	65.0 (2.56)	-	2
	2 ①	387.4 (15.25)	127.0 (5.00)	79.5 (3.13)	63.5 (2.50)	273.1 (10.75)	-	115.8 (4.56)	339.9 (13.38)	80.8 (3.18)	-	2
	2-1/2 ①	581.2 (22.88)	179.3 (7.06)	117.6 (4.63)	95.3 (3.75)	444.5 (17.50)	-	138.2 (5.44)	511.3 (20.13)	111.3 (4.38)	-	4
	3 ①	581.2 (22.88)	185.7 (7.31)	117.6 (4.63)	95.3 (3.75)	444.5 (17.50)	-	173.0 (6.81)	511.3 (20.13)	111.3 (4.38)	-	4
	3-1/2 ①	784.4 (30.88)	261.9 (10.31)	143.0 (5.63)	114.3 (4.50)	632.0 (24.88)	-	214.4 (8.44)	698.5 (27.50)	133.4 (5.25)	-	4
	4 ①	784.4 (30.88)	261.9 (10.31)	143.0 (5.63)	114.3 (4.50)	632.0 (24.88)	-	214.4 (8.44)	698.5 (27.50)	133.4 (5.25)	-	4

① Furnished with rollers for easier cable pulling.