

# WALL PLATES

## Specifications



**Thermoset  
SP Series**



**Nylon  
TP Series**



**Screwless  
Polycarbonate  
SWP Series**



**302/304  
Stainless  
Steel**

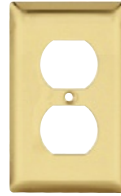

**Polished  
Brass**

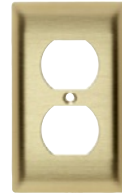

**Brushed  
Brass**



**Aluminum**

## Application

Legrand's broad line of Pass & Seymour® Standard Size Plastic and Metal Wall Plates features the most complete range of types, sizes, colors, and finishes available. Choose from more than 1,900 standard plates in non-combustible thermoset plastic material, self-extinguishing nylon material, screwless polycarbonate material, or attractively finished metal, for residential, commercial, institutional, and industrial applications. All plastic wall plates color match to Pass & Seymour devices.

### Thermoset Plastic Wall Plates

- Molded of non-combustible mar-proof material.
- Available in "SP" series in Standard, Junior-Jumbo, and Jumbo sizes.
- Seven standard colors available – Ivory, White, Brown, Gray, Black, Red, and Light Almond.
- Individually wrapped with color-matching screws.
- Resistant to discoloration, grease, oil, solvent and moisture.
- Nominal thickness, .070"

### TradeMaster® Thermoplastic Wall Plates

- Molded of rugged, practically indestructible self-extinguishing nylon. ("TP" series only)
- Available in "TP" series, extra 3/16" width and height than Standard size plates; and "TPJ" series, extra 3/16" width and height than Junior-Jumbo size plates.
- Available in Ivory, White, Brown, Gray, Black, Blue, Orange, Red, and Light Almond.
- Preferred for hospital, industrial, institutional, and other high-abuse applications.
- Nominal thickness, .070"

### Screwless Polycarbonate Wall Plates

- Molded of .065" thick polycarbonate, matte finish.
- 2-piece plastic subplate made of polycarbonate.
- Extra 1/8" width and height than Standard size plates.
- Available in Ivory, White, Brown, Gray, Black, and Light Almond; and three metallic finishes.

### Metal Wall Plates

- Constructed of corrosion-resistant stainless steel, brass, aluminum, chrome, brushed bronze or galvanized steel.
- Standard, Jumbo, and Tandem size plates available, as well as special Panel size plates up to 5-gangs high and 10-gangs wide.
- Packaged in protective film, with finish-matching screws.
- Variety of special plated finishes. Paintable to match plastic plates.
- Can be silk-screened or engraved, and custom punched with over 300 opening styles.

### Materials

- Type 302/304 Stainless Steel, non-magnetic, .032" nominal thickness, brushed finish. This alloy contains 18% chromium and 8% nickel for superior resistance to corrosion. Recommended for use in food processing plants, dairies, chemical plants, and other industrial, institutional, and commercial applications where corrosive atmospheres exist.
- Type 430 Stainless Steel, magnetic, .032" nominal thickness, brushed finish. Less corrosion-resistant than Type 302/304, but ideal for general service in high abuse applications in industrial plants, commercial, and institutional buildings.
- Chrome, Brushed and Polished Brass, .040" thick. 70% copper, 30% zinc alloy gives warm, appealing finish to modern decor as well as retrofit applications. Lacquered to prevent corrosion.
- Aluminum, .040" thick. Lustrous satin finish. Lacquered to prevent corrosion.
- Galvanized Steel. Used only for Handy Box Plates.
- Brushed Bronze, .040" thick. 90% copper, 10% zinc. Lacquered to prevent corrosion.

# WALL PLATES

## Dimensions

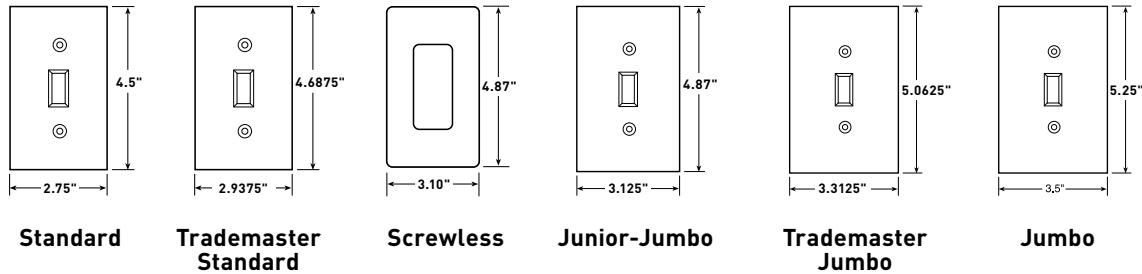

### Standard Size Wall Plates

- Standard size wall plates for all applications.
- Best fit for surface mount boxes.
- Available in plastic and metal only.

#### Dimensions

<b>1 gang</b>	2.75" x 4.5"
<b>2 gang</b>	4.56" x 4.5"
<b>3 gang</b>	6.375" x 4.5"
<b>4 gang</b>	8.125" x 4.5"
<b>5 gang</b>	10" x 4.5"
<b>6 gang</b>	11.812" x 4.5"
<b>7 gang</b>	13.62" x 4.5"
<b>8 gang</b>	15.44" x 4.5"

### TradeMaster® Wall Plates

- Extra 3/16" width and height than Standard size wall plates.
- Provide better sheet rock coverage with standard size appearance.
- Available in unbreakable nylon 6 construction only.
- Screws pre-installed in the duplex, toggle and decorator single gang plates.

#### Dimensions

<b>1 gang</b>	2.9375" x 4.6875"
<b>2 gang</b>	4.75" x 4.6875"
<b>3 gang</b>	6.563" x 4.6875"
<b>4 gang</b>	8.375" x 4.6875"
<b>5 gang</b>	10.188" x 4.6875"
<b>6 gang</b>	12" x 4.6875"

### Screwless Polycarbonate Wall Plates

- Available in decorator openings.
- Extra 1/8" width and height than Standard size wall plates.
- Provide better sheet rock coverage with standard size appearance.
- Molded of .065" thick polycarbonate.
- 2-piece plastic subplate made of polycarbonate.
- Available in 3 metallic finishes and 6 standard colors.

#### Wall Plate Dimensions

<b>1 gang</b>	3.10" x 4.87"
<b>2 gang</b>	4.912" x 4.87"
<b>3 gang</b>	6.724" x 4.87"
<b>4 gang</b>	8.536" x 4.87"

#### Subplate Dimensions

<b>1 gang</b>	2.85" x 4.62"
<b>2 gang</b>	4.662" x 4.62"
<b>3 gang</b>	6.474" x 4.62"
<b>4 gang</b>	8.286" x 4.62"

### Junior-Jumbo Wall Plates

- Extra 3/8" width and height than Standard size wall plates.
- Additional coverage for sheet rock gaps.
- Available in plastic and metal only.

#### Dimensions

<b>1 gang</b>	3.125" x 4.87"
<b>2 gang</b>	4.93" x 4.87"
<b>3 gang</b>	6.75" x 4.87"
<b>4 gang</b>	8.56" x 4.87"

### TradeMaster® Jumbo Wall Plates

- Extra 3/16" width and height than Junior-Jumbo size wall plates.
- Provide additional coverage for sheet rock gaps, matching the appearance of the TradeMaster Plates.
- Available in unbreakable nylon 6 construction only.
- Screws pre-installed in the duplex, toggle, and decorator single gang plates.

#### Dimensions

<b>1 gang</b>	3.3125" x 5.0625"
<b>2 gang</b>	5.125" x 5.0625"
<b>3 gang</b>	6.9375" x 5.0625"
<b>4 gang</b>	8.75" x 5.0625"

### Jumbo Wall Plates

- Extra 3/4" width and height than Standard size wall plates.
- Largest size wall plates to cover larger wall damage.
- Available in plastic and metal only.

#### Dimensions

<b>1 gang</b>	3.5" x 5.25"
<b>2 gang</b>	5.31" x 5.25"
<b>3 gang</b>	7.12" x 5.25"
<b>4 gang</b>	8.93" x 5.25"

# WALL PLATES

## Dimensions

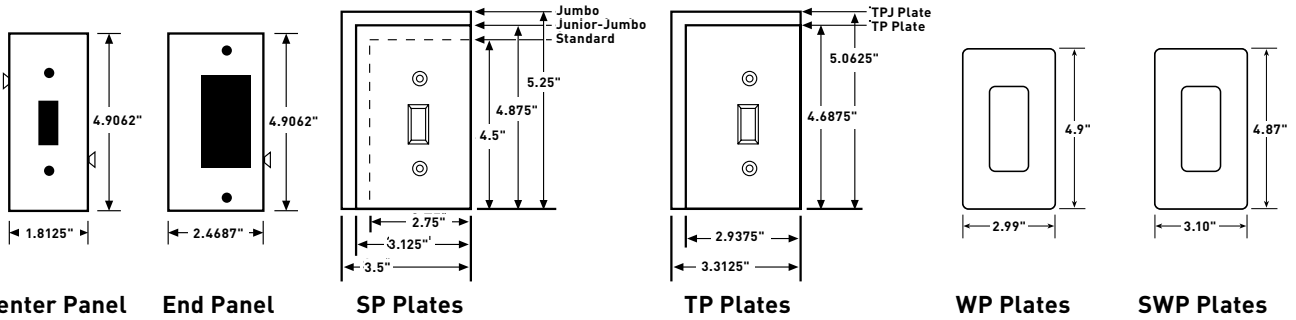

Center Panel   End Panel   SP Plates   TP Plates   WP Plates   SWP Plates

## Sectional Wall Plates

End and center panels with each of five most-used configurations make it possible to improvise custom wall plates on the job. Panels lock securely together on installation. Blank sections furnished with mounting strap.

## Wall Plate Mountings

Illustrated are the five standard methods of plate mounting. There are many other non-standard methods which depend upon the special device used. Exact mounting hole specifications for every device appear in the Selector Guide.

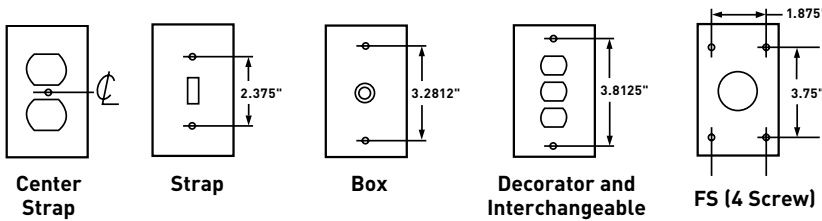



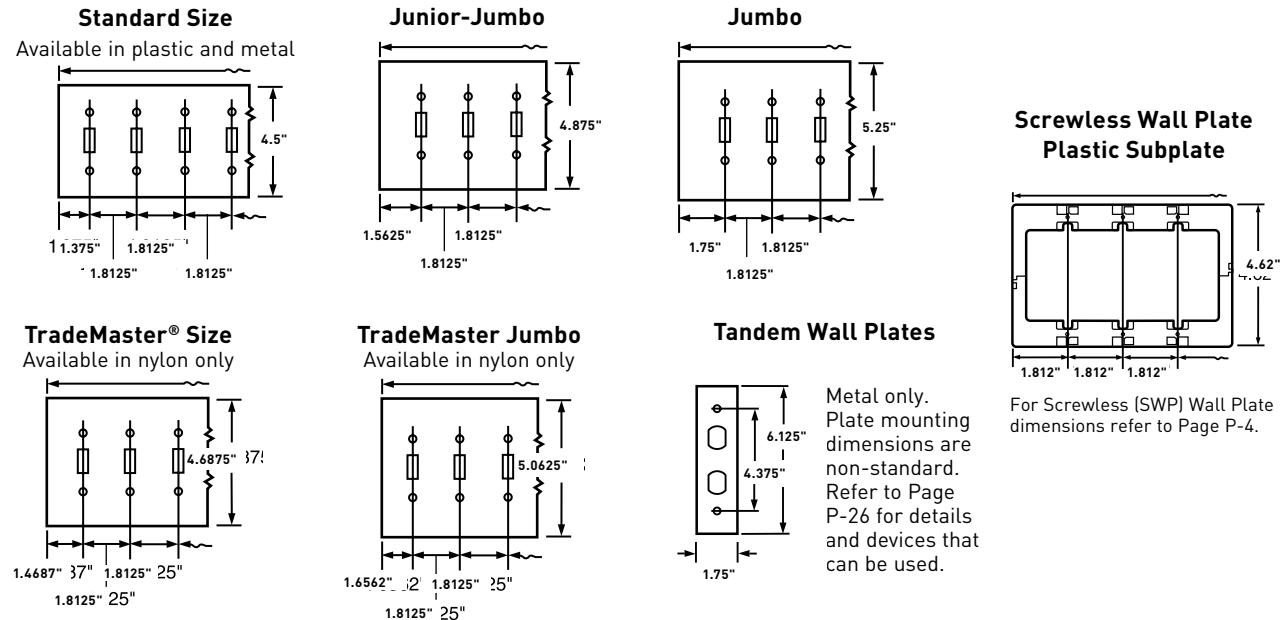

Center Strap   Strap   Box   Decorator and Interchangeable   FS (4 Screw)

## Wall Plate Sizes



# WALL PLATES

## Louver & Biplex/Triplex Openings Standard Size Metal

DESCRIPTION	COLOR	NYLON	THERMOSET	METAL	
		TRADEMASTER® PLATES	SMOOTH	MATERIAL	SMOOTH
<b>LOUVER PLATES</b>					
<b>One Gang</b> Horizontal 				Brass 302/304 S/S 302/304 S/S Painted Ivory 302/304 S/S Painted White 302/304 S/S Painted Light Almond	SB760 SS760 SS760I SS760W SS760LA
<b>One Gang</b> Vertical 				Brass 302/304 S/S 302/304 S/S Painted Ivory 302/304 S/S Painted White 302/304 S/S Painted Brown 302/304 S/S Painted Gray 302/304 S/S Painted Light Almond	SB771 SS771 SS771I SS771W SS771X SS771GRY SS771LA
<b>Two Gang</b> Vertical 				302/304 S/S	SS772
<b>BIPLEX/TRIPLEX RECEPTACLE</b>					
<b>One Gang</b> 1 Biplex/Triplex 				302/304 S/S	SS9

# DEVICES & WALL PLATES

## Color Selection Chart

### Devices & Plastic Wall Plate Colors

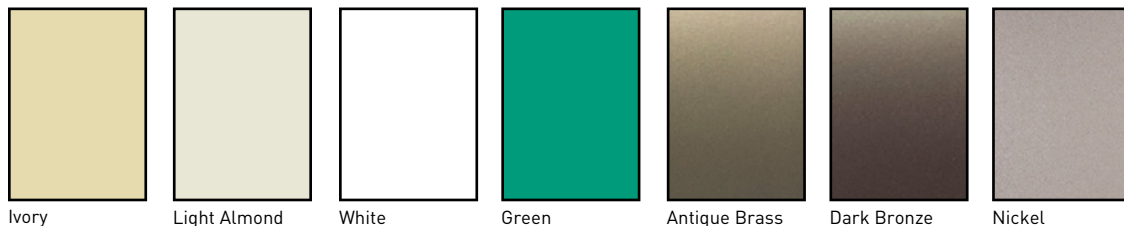

Ivory    Light Almond    White    Green    Antique Brass    Dark Bronze    Nickel

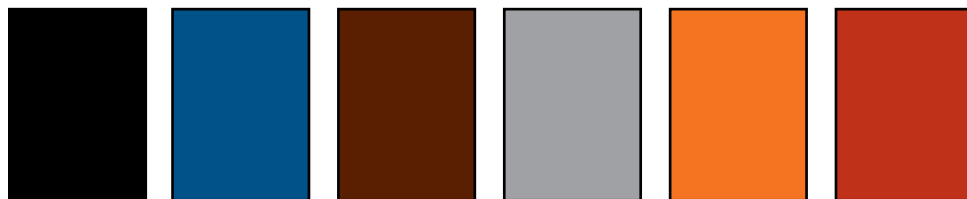

Black    Blue    Brown    Gray    Orange    Red

See specific device and wall plate catalog charts for particular color availabilities.

### Metal Wall Plates

Metal Finish

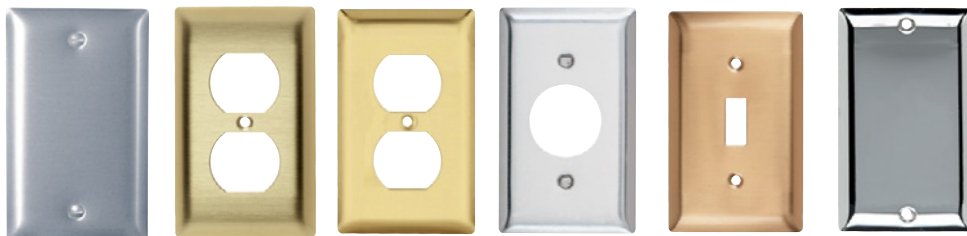

Aluminum    Brass (Brushed)    Polished Brass    Stainless Steel    Brushed Bronze    Chrome

### Custom Metal Wall Plates Paint Finish Colors

Paint Color

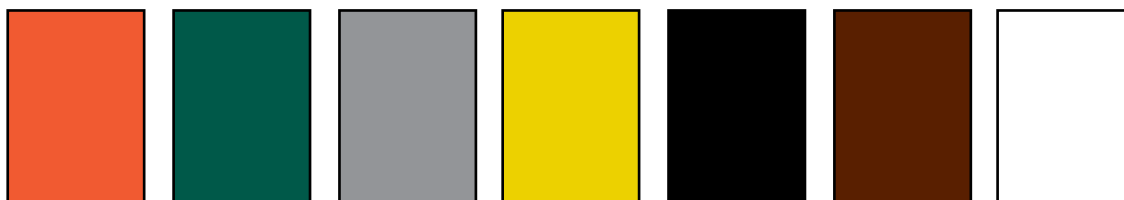

Orange    Green    Gray    Yellow    Glossy Black    Brown    White



Primer    Red    Pink    Flat Black    Ivory    Light Almond    Blue

To order custom metal wall plates, see Pages P-40 – P-42.  
**For additional colors consult factory.**