

FLANGE-MOUNTED 1/4 TURN LOCKS

Door locks for ESCH series enclosures

The **880 SCQ2 series** door lock accessories are designed to fit ESCH series enclosures. A full range of accessories are available to accommodate a variety of applications.

- These accessories include :
- Slot lock in zinc casting and stainless steel.
 - Padlock provision in zinc casting and stainless steel.
 - 3 inserts types, key lock, knob

A new mounting clip facilitates the installation and removal of the flange mounted 1/4 turn locks. This innovative lock design was engineered by Eurobex and is used only on Eurobex products.



Slot lock
CATALOG # : 880 SCQ2S
KEY NUMBER : None
Key included? : N/A
Material : Zinc casting
For use with : ESCH series, 1500 CS, 880 HWK



Stainless steel slot lock
CATALOG # : 880 SCQ3S
KEY NUMBER : None
Key included? : N/A
Material : Stainless steel
For use with : ESSCH series, EALCH series...



Padlock
Zinc cast # : 880 SCQ2P
For use with : ESCH series, 1500 CS, 880 HWK
Stainless steel #: 880 SCQ3P
For use with : ESSCH series, EALCH series...



Wing knob
CATALOG # : 880 SCQ2WN
KEY NUMBER : None
Key included? : No tool required
Material : Zinc casting
For use with : ESCH series, 1500 CS, 880 HWK



Key lock
CATALOG # : 880 SCQ2K
KEY NUMBER : K-ESCHK
Key included? : Yes
Material : Zinc casting
For use with : ESCH series, 1500 CS, 880 HWK



Double bit lock
CATALOG # : 880 SCQ2DB
KEY NUMBER : K-DB3
Key included? : No
Material : Zinc casting
For use with : ESCH series, 1500 CS, 880 HWK



Triangular lock
CATALOG # : 880 SCQ2TR
KEY NUMBER : K-TR7
Key included? : No
Material : Zinc casting
For use with : ESCH series, 1500 CS, 880 HWK



Square lock
CATALOG # : 880 SCQ2SQ
KEY NUMBER : K-SQ6
Key included? : No
Material : Zinc casting
For use with : ESCH series, 1500 CS, 880 HWK

The 880 SCQ2 accessories are to be used with these enclosure series, amongst others :



5100 ESCH
5412 ESCH



5412 ESSCH
5412 ESSPCH



5412 ESLC
5412 EALLC



1500 CS
1500 CSS



880 HWK
886 HWK

Data subject to change without notice.

Oil and dust tight consolets

Quick Features :

- Flange-mounted ¼ turn lock
- Superior hinging
- Drip shield
- 35° or 55° control surface
- Seamless welding
- Poured gasket
- Powder coated

The 1500 CS oil and dust tight consolets are used indoors to protect electrical equipment against dirt, dust, oil and water splashing. The 1500 CS consolets can be mounted on pedestals (1500 PE, see previous page), desktops or machines with the choice of a control surface of 35° or 55°. Consolets are

made from 14 GA steel with all seams continuously welded. The cover has a continuous formed hinge. The door is secured by Eurobex's exclusive flange-mounted quarter-turn locks which ensure positive closing. (Note that padlockable locks and key locks are available.) A high quality seamless poured gasket is

used to ensure the integrity of the enclosure. Pedestals and base, if required, must be ordered separately. Consolets are finished with heat fused polyester powder, electrostatically applied on a phosphatized base. Box is ANSI/ASA 61 gray.

CSA Certified / UL Listed
NEMA 12-13 / IP65

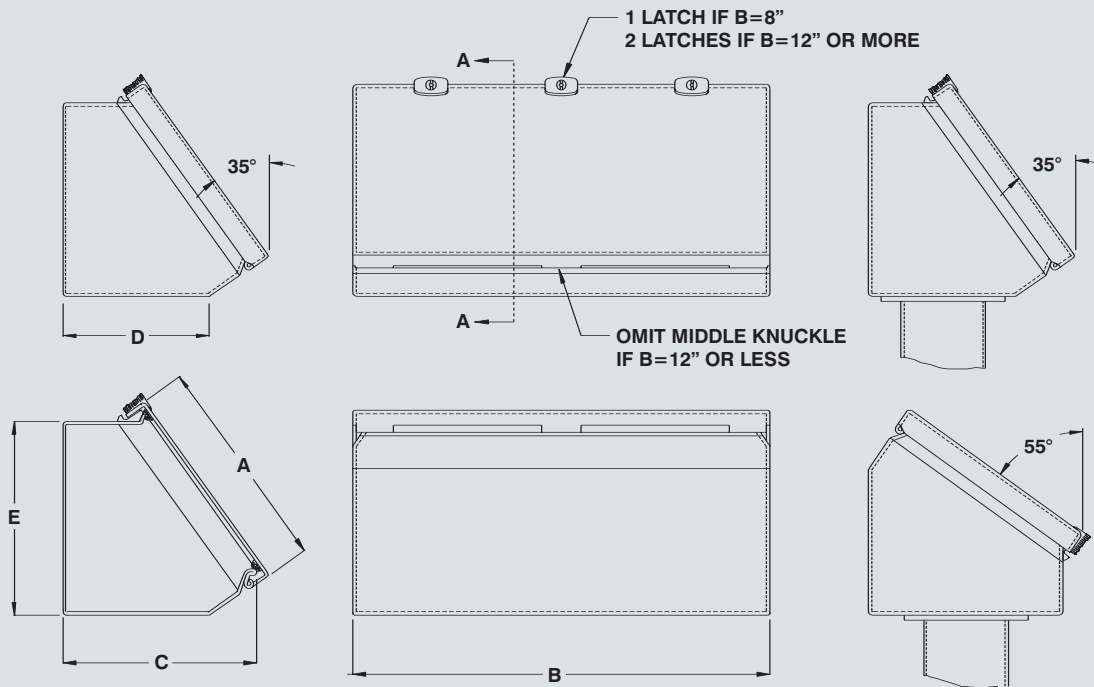

Visit www.eurobex.com for details.

Call us toll free 1-800-363-2423

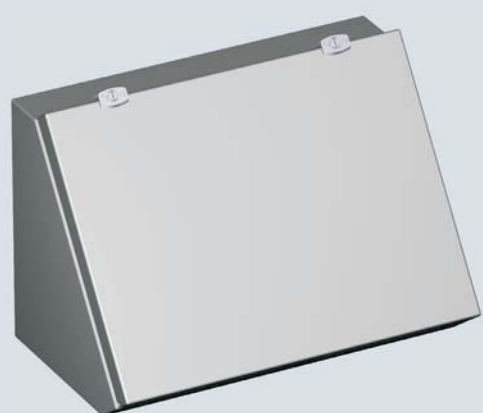

CATALOG NUMBER	DIMENSIONS					SHIP WGT LBS.
	A	B	C	D	E	
1500 CS080807	8	8	7.281	5.375	7.437	8
1500 CS081207	8	12	7.281	5.375	7.437	10
1500 CS081607	8	16	7.281	5.375	7.437	13
1500 CS082007	8	20	7.281	5.375	7.437	16
1500 CS121209	12	12	9.562	7.687	10.718	15
1500 CS121609	12	16	9.562	7.687	10.718	18
1500 CS122009	12	20	9.562	7.687	10.718	22
1500 CS122409	12	24	9.562	7.687	10.718	26
1500 CS161611	16	16	11.875	9.968	14.000	22
1500 CS162011	16	20	11.875	9.968	14.000	27
1500 CS162411	16	24	11.875	9.968	14.000	32
1500 CS163011	16	30	11.875	9.968	14.000	39
1500 CS163611	16	36	11.875	9.968	14.000	45
1500 CS202013	20	20	14.187	12.250	17.250	36
1500 CS202413	20	24	14.187	12.250	17.250	42
1500 CS203013	20	30	14.187	12.250	17.250	49

Data subject to change without notice.

Suggested Accessories



p.341

p.341

p.341

p.364

p.375

p.376

p.378