

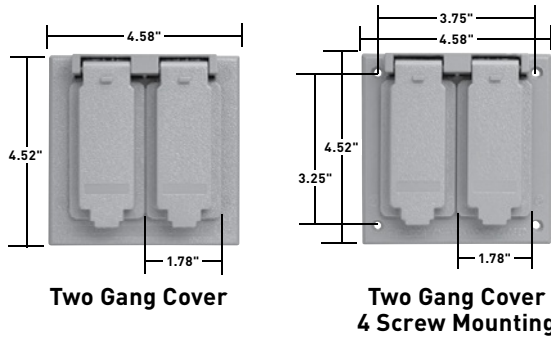











# WEATHERPROOF BOXES & COVERS

## Cast Weatherproof Covers



### Features

- Broad line of two gang covers for switches, receptacles, GFCIs, and power outlets.
- Baked-on electrostatic, polyester, powder paint for superior scratch and corrosion resistance.
- Heavy-duty die-cast zinc.
- Stainless steel springs.
- All covers have 2 self-closing lids.
- Covers comply with NEC® Section 406.9(B)(1).

| CATALOG NUMBER  | DESCRIPTION  | COLOR         | 3RD PARTY COMPLIANCE   |
|-----------------|--|---------------|--|
|                 |  |               |  |
| <b>TWO GANG</b> |  |               |  |
| CA82G<br>CA82W  |  2 Duplex Receptacles  | Gray<br>White | •  |
| CA72G           |  2 Single Receptacles   | Gray          | •  |
| CA78G           |  1 Single/1 Duplex 4 Screw Mounting   | Gray          | •  |
| CA726G          |  1 Single/1 Decorator 4 Screw Mounting  | Gray          | •  |
| CA262G          |  2 Decorator 4 Screw Mounting   | Gray          | •  |
| CA268G          |  1 Decorator/1 Duplex 4 Screw Mounting  | Gray          | •  |
| CA17G           |  1 Toggle/1 Single 4 Screw Mounting   | Gray          | •  |
| CA18G           |  1 Toggle/1 Duplex 4 Screw Mounting   | Gray          | •  |
| CA126GRY        |  1 Toggle/1 Decorator 4 Screw Mounting  | Gray          | •  |
| CA2G<br>CA2W    |  2 Toggles<br>4 Screw Mounting  | Gray<br>White | •  |
| CA2GS           |  2 Toggles with 2 15A 120VAC<br>Single Pole Toggle Switches (Cat. # 660) Included<br>4 Screw Mounting | Gray          | •  |