

rotary switches

reliable switching to 100A

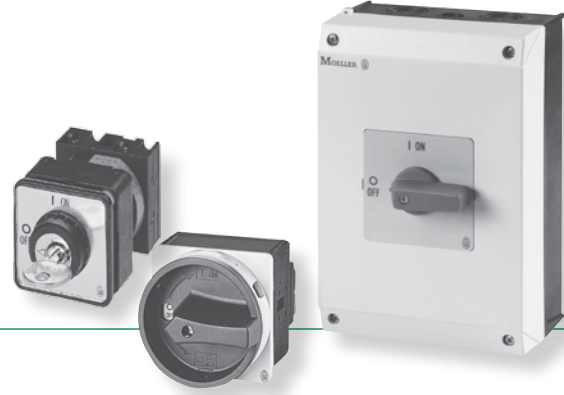

M

Rotary Switches



Moeller series rotary switches are an economic choice for the simple logic functions and manual switching required in many industrial applications. From simple ON-OFF disconnects, to reversing wye-delta motor control, Moeller series rotary switches offer an array of standard and custom switches to precisely match your functional requirements.

Switching to your application

Moeller series rotary switches contain two switch lines, each with two frame sizes, that can handle loads to 100A or 75HP @ 575V. As with other world class Moeller series products, you can expect the highest level of reliability from these devices.

The "T" rotary switch line is highly versatile, allowing for many configuration options such as step load switching, control switching and specialty selectors.

The "P" motor disconnect line has a robust amp and horsepower capacity, with optional built-in auxiliary contacts in our standard selection.

Red handles and yellow faceplate options are available, allowing for approved emergency-stop switches in all product lines and frame sizes.

Versatile switching, versatile mounting

All switches are available in multiple mounting types including traditional flush and base mounting. Many switches are also available with center hole mounting as well as pre-mounted in an NEMA 3R (IP65) enclosure. Multiple mounting options provide application flexibility so you can build the switch to fit your machine instead of the other way around.

> Single phase and three phase switches

> Up to 100A / 75HP (@ 575V)

> Custom switches available with quick turnaround

> Keyed and non-keyed switches



Flush Mounting

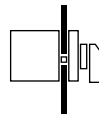

Suitable for panel or machine mounting

Base Mounting

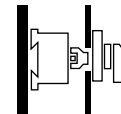

Designed for through-the-door mounting of enclosed systems

Center Hole Mounting

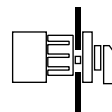

Switch is mounted in panel or machine with standard 22.5 mm hole (same as pilot devices)

Enclosed

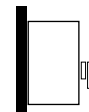

Switch is self-enclosed in insulated plastic enclosure. Rated to NEMA 1, 12 & 3R and IP65.



Offering the right stuff

Various handle types, shrouds, shaft extensions, neutral terminals and keyed operator accessories are available to round out the line, making it easy to use the right stuff for your application.



Approved for export or domestic use

Along with UL / CSA approvals, rotary switches are also approved for export with IEC and VDE. In addition, all enclosed rotary switches can be ordered with ATEX approvals (for explosive atmospheres). See page M40 for ATEX information.







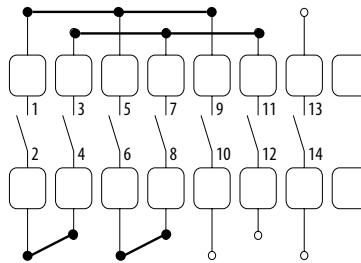

Designed by the right person – YOU!

The nature of rotary switches allows for many different configurable combinations. We maintain a custom rotary switch facility in North America where contact design and behavior can be configured to your exact specifications within a week. Custom faceplates are engraved on location with a quick turnaround. Even master key systems are available. Sales representatives are always ready to assist in designing the switch you need... fast!





Custom rotary switch options include engraved faceplates, master key systems, and contact behavior configurations (illustrated left).

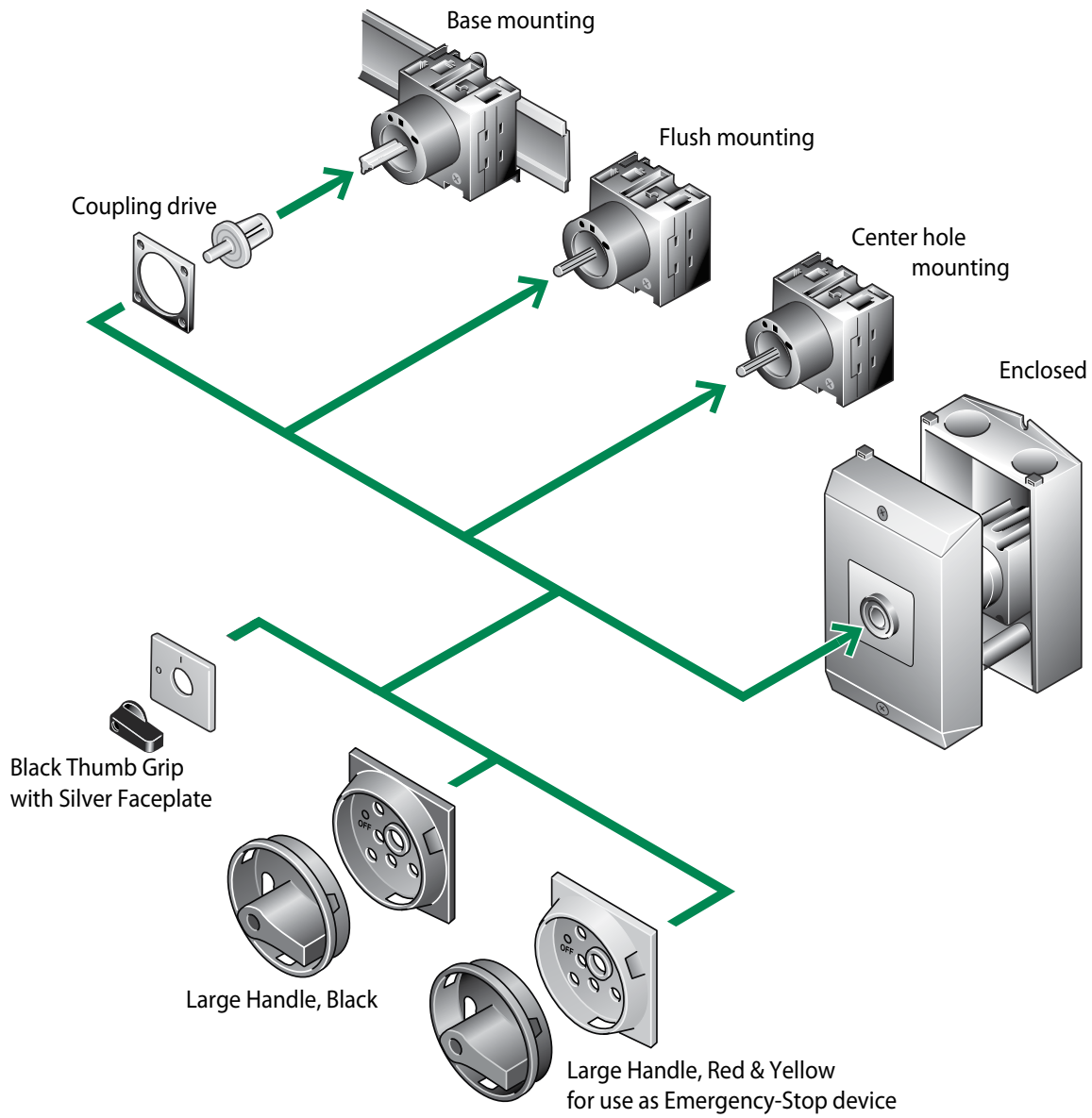

Feature Comparison

| Rotary Switch Series | | Amperes | Flush Mounting | Base Mounting | Center Hole Mounting | Enclosed | Customizable | Maximum Chambers | Max Chambers when enclosed | Single Phase (page XX) | Three Phase (page XX) | Control Switches (page XX) | Specialty Switches (page XX) |
|--|------------------|--|----------------|---------------|----------------------|----------|--------------|------------------|----------------------------|------------------------|-----------------------|----------------------------|------------------------------|
| P Series Rotary Disconnect Switches | | | | | | | | | | | | | |
| P | Small Frame Size | P1-25...  20 Amps | ✓ | ✓ | ✓ | ✓ | | | | ✓ | ✓ | | |
| | | P1-32...  30 Amps | ✓ | ✓ | ✓ | ✓ | | | | ✓ | ✓ | | |
| | Large Frame Size | P3-63...  60 Amps | ✓ | ✓ | | ✓ | | | | ✓ | ✓ | | |
| | | P3-100...  100 Amps | ✓ | ✓ | | ✓ | | | | ✓ | ✓ | | |
| T Series Rotary Cam Switches | | | | | | | | | | | | | |
| T | Small Frame Size | T0...  16 Amps | ✓ | ✓ | ✓ | ✓ | ✓ | 11 | 4 | ✓ | ✓ | ✓ | ✓ |
| | | T3...  25 Amps | ✓ | ✓ | ✓ | ✓ | ✓ | 11 | 5 | ✓ | ✓ | ✓ | ✓ |
| | Large Frame Size | T5B...  65 Amps | ✓ | ✓ | | ✓ | ✓ | 10 | 4 | ✓ | ✓ | ✓ | ✓ |



Rotary Switches Overview

| Device | Description | Range | Pages |
|---|---|---|-----------|
| Rotary Switches | | | |
|  | Single Phase Switches Motor Disconnect On-Off Emergency-Stop Changeover Reversing | Up to 15 HP @230V; Up to 100 Amps | M10 – M15 |
| | Three Phase Switches Motor Disconnect On-Off Emergency-Stop Changeover Reversing Star-Delta Multi-Speed | Up to 75 HP @575V; Up to 100 Amps | M16 – M25 |
| | Control Switches Step (2 – 6 steps) On-Off Hand-Auto On (make contact) Changeover Series | | M26 – M32 |
| | Specialty Switches Multi-purpose Coding Voltmeter Ammeter Voltmeter & Ammeter | | M33 – M35 |
| Accessories | | | |
|  | Handles Keyed Operators Terminals Extensions Shrouds | | M36 – M39 |

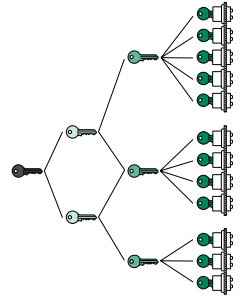
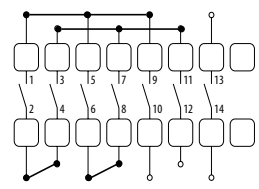
| Device | Description | Pages |
|--|--|-----------|
| Enclosures | | |
|  | Enclosures | M40 |
| Faceplates | | |
|  | Alternate faceplates Blank faceplates Custom engraved faceplates | M41 – M52 |
| Master Key System | | |
|  | Master key system for keyed operators | M53 – M58 |
| Custom Switches | | |
|  | Custom rotary switches | M59 – M65 |

M Rotary Switches

The Moeller series catalog numbering system for rotary switches and other devices follows a logical system. Device attributes can be determined by the following nomenclature.

Dashes (–) and slashes (/) are used to separate device attributes and should always be included when ordering.

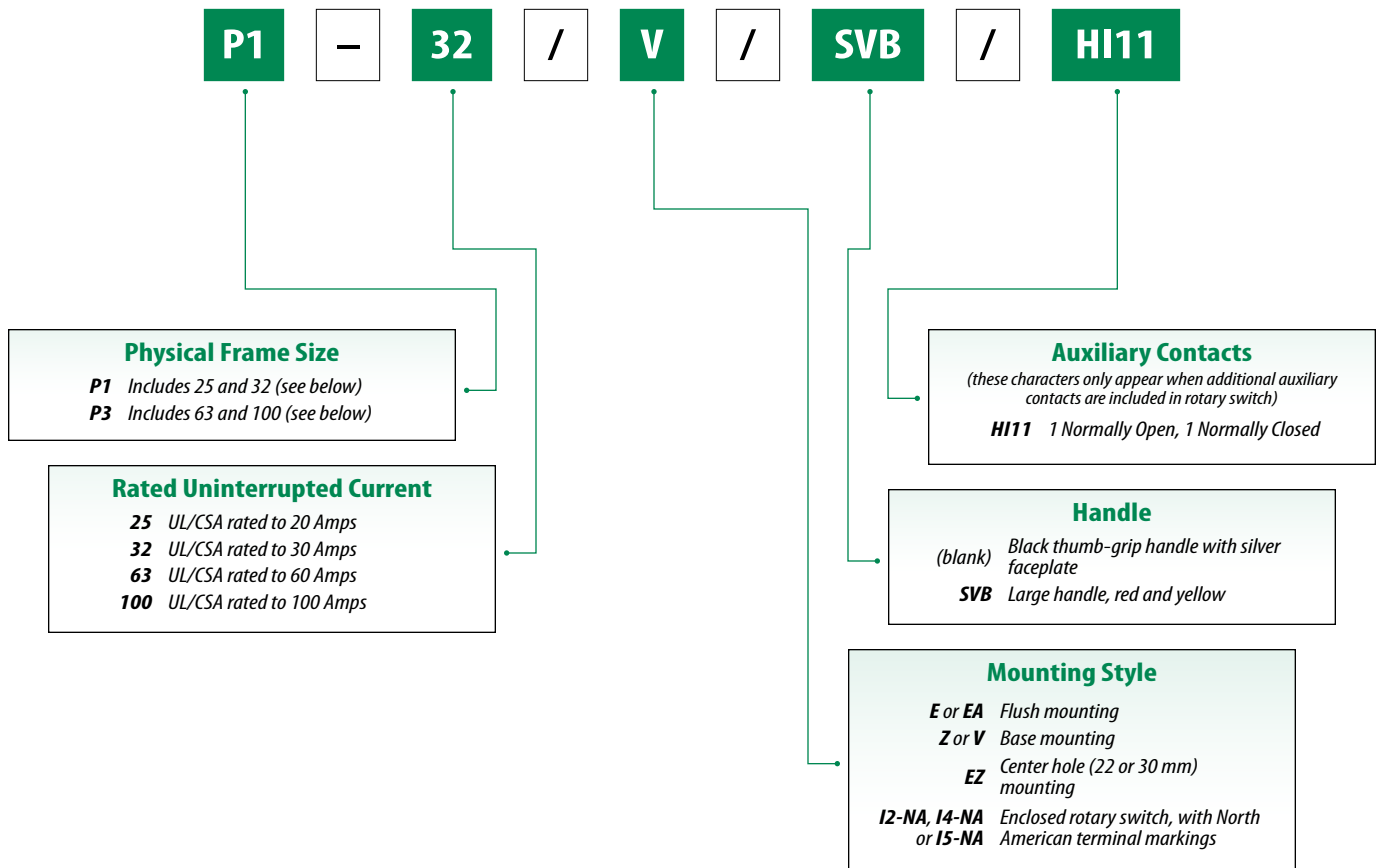

This page for reference only.
 Please turn to the appropriate pages to determine the exact device and/or accessories required for your application.

Single Phase Switches ①

| No. of Poles | Standard Faceplate (for other options, note faceplate code and frame size of desired switch and turn to page M41.) | Contact Sequence | Rated for Applications | Built-in Auxiliary Contacts | | Single Phase Max. Motor Rating [HP] | | | Current Rating UL/CSA | Handle | | | | | | |
|------------------------|---|------------------|--|-----------------------------|--|-------------------------------------|-------|-------|-----------------------|--|---|----|----|----|----|--|
| | | | | NO | NC | @115V | @200V | @230V | | | | | | | | |
| ON-OFF Switches | | | | | | | | | | | | | | | | |
| 1 | | | Motor Disconnect Switch On-Off Switch Emergency-Stop ② | 0 | 0 | ¾ | 2 | 2 | 16 | Black / Silver Padlockable - Red / Yellow | | | | | | |
| | | | | | | 1½ | 3 | 3 | 25 | Black / Silver Padlockable - Red / Yellow | | | | | | |
| | | | | | | 3 | 7½ | 10 | 65 | Black / Silver Padlockable - Red / Yellow | | | | | | |
| 2 | Black / Silver handles: FS 908 | | Motor Disconnect Switch On-Off Switch Emergency-Stop ② | 0 | 0 | ¾ | 2 | 2 | 16 | Black / Silver Padlockable - Red / Yellow | | | | | | |
| | | | | | | 1½ | 3 | 3 | 25 | Black / Silver Padlockable - Red / Yellow | | | | | | |
| | | | | | | 3 | 7½ | 10 | 65 | Black / Silver Padlockable - Red / Yellow | | | | | | |
| 3 | Padlockable handles are not supplied with faceplate. Padlockable handles are marked: I ON O OFF | | On-Off Switch Emergency-Stop ② | 0 | 0 | ¾ | 2 | 2 | 16 | Black / Silver Padlockable - Red / Yellow | | | | | | |
| | | | These switches can also be used in three phase applications. See page M16 for ratings. | | | | | | | | | | | | | |
| | | | Motor Disconnect Switch On-Off Switch Emergency-Stop ② | | | | | | | 0 | 0 | 1½ | 3 | 3 | 20 | Black / Silver Padlockable - Red / Yellow |
| | | | These switches can also be used in three phase applications. See page M16 for ratings. | | | | | | | | | 2 | 3 | 5 | 30 | Black / Silver Padlockable - Red / Yellow |
| | | | | | | | | | | | | 3 | 7½ | 10 | 60 | Black / Silver Padlockable - Red / Yellow |
| | 5 | 10 | 15 | 100 | Black / Silver Padlockable - Red / Yellow | | | | | | | | | | | |

Custom switch configurations available - see page M59 for details.

- ① Non-enclosed switches are supplied with European terminal markings (1, 3, 5, etc.). For North American terminal markings (L1, L2, L3, etc.), add suffix -NA to catalog number and add \$25 to price. Enclosed switches have North American terminal markings as standard.
- ② Choose Red / Yellow or Padlockable - Red / Yellow handle for Emergency-stop applications.

Ordering Instructions





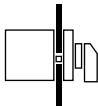
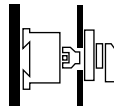
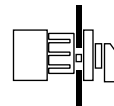
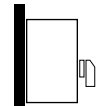

- 1 Locate the desired rotary switch.
- 2 Order accessories separately on pages M36 – M40.

Standard Handle Types

| Black / Silver | Padlockable - Red / Yellow |
|--|---|
| | |
| Black handle Silver faceplate NEMA 1 | Red/Yellow handle, NEMA 3R Padlockable in OFF position Suitable for emergency-stop applications |

| Flush Mounting | | Base Mounting | | Center Hole (22.5 / 30 mm) Mounting | | Enclosed NEMA 12, 3R (IP65) Insulated Plastic | |
|---|-------|---|-------|---|-------|--|-------|
|  | |  | |  | |  See page M40 for ATEX information. | |
| Catalog Number | Price | Catalog Number | Price | Catalog Number | Price | Catalog Number | Price |
| ON-OFF Switches | | | | | | | |
| T0-1-8200/E | | T0-1-8200/Z | | T0-1-8200/EZ | | T0-1-8200/I2-NA | |
| T0-1-8200/EA/SVB | | T0-1-8200/V/SVB | | – | | T0-1-8200/I2/SVB-NA | |
| T3-1-8200/E | | T3-1-8200/Z | | T3-1-8200/EZ | | T3-1-8200/I2-NA | |
| T3-1-8200/EA/SVB | | T3-1-8200/V/SVB | | – | | T3-1-8200/I2/SVB-NA | |
| T5B-1-8200/E | | T5B-1-8200/Z | | – | | T5B-1-8200/I4-NA | |
| T5B-1-8200/EA/SVB | | T5B-1-8200/V/SVB | | – | | T5B-1-8200/I4/SVB-NA | |
| T0-1-102/E | | T0-1-102/Z | | T0-1-102/EZ | | T0-1-102/I2-NA | |
| T0-1-102/EA/SVB | | T0-1-102/V/SVB | | – | | T0-1-102/I2/SVB-NA | |
| T3-1-102/E | | T3-1-102/Z | | T3-1-102/EZ | | T3-1-102/I2-NA | |
| T3-1-102/EA/SVB | | T3-1-102/V/SVB | | – | | T3-1-102/I2/SVB-NA | |
| T5B-1-102/E | | T5B-1-102/Z | | – | | T5B-1-102/I4-NA | |
| T5B-1-102/EA/SVB | | T5B-1-102/V/SVB | | – | | T5B-1-102/I4/SVB-NA | |
| T0-2-1/E | | T0-2-1/Z | | T0-2-1/EZ | | T0-2-1/I2-NA | |
| T0-2-1/EA/SVB | | T0-2-1/V/SVB | | – | | T0-2-1/I2/SVB-NA | |
| P1-25/E | | P1-25/Z | | P1-25/EZ | | P1-25/I2-NA | |
| P1-25/EA/SVB | | P1-25/V/SVB | | – | | P1-25/I2/SVB-NA | |
| P1-32/E | | P1-32/Z | | P1-32/EZ | | P1-32/I2-NA | |
| P1-32/EA/SVB | | P1-32/V/SVB | | – | | P1-32/I2/SVB-NA | |
| P3-63/E | | P3-63/Z | | – | | P3-63/I4-NA | |
| P3-63/EA/SVB | | P3-63/V/SVB | | – | | P3-63/I4/SVB-NA | |
| P3-100/E | | P3-100/Z | | – | | P3-100/I5-NA | |
| P3-100/EA/SVB | | P3-100/V/SVB | | – | | P3-100/I5/SVB-NA | |

Optional Handles - Order Separately (see page M36 for details and other options)

| For Switch Frames | Options for Black / Silver handles | | | | | | | | | | Options for Padlockable - Red / Yellow handles | |
|-------------------|---|-------------|---|-------------|---|-------------|---|-------------|---|-------------|---|--|
| | Red Handle / Yellow Faceplate | | | | Cylinder Lock: Key operated Silver faceplate | | Cylinder Lock: Black handle Silver faceplate | | Padlock Mechanism: Black handle Silver faceplate | | Padlockable Black Handle | |
| |  | |  | |  | |  | |  | |  | |
| | Handle | Faceplate | Not UL/CSA approved | | Not UL/CSA approved | | Not UL/CSA approved | | NEMA 3R | | | |
| Catalog No. | Price | Catalog No. | Price | Catalog No. | Price | Catalog No. | Price | Catalog No. | Price | Catalog No. | Price | |
| T0, T3, P1 | KNB-RT-T0 | | FS908GE-T0 | | S-T0 | | SVA-T3 | | SVC-T3 | | SVB-SW-T0 | |
| T5B, P3 | KNB-RT-P3 | | FS908GE-P3 | | – | | – | | – | | SVB-SW-P3 | |

| Rotary Switches | | | P1-25... | P1-32... | P3-63... | P3-100... | |
|---|--------------|----------------------|--|-------------------------------|-------------------------------|-------------------------------|----|
| General | | | | | | | |
| Standards | | | IEC/EN 60947, VDE 0660, IEC/EN 60204, CSA, UL Switch-disconnectors to IEC/EN 60947-3 | | | | |
| UL report number | | | E36332 | | | | |
| CSA report number | | | 012528 | | | | |
| Lifespan, mechanical | Operations | [x 10 ⁶] | 0.3 | 0.3 | 0.1 | 0.1 | |
| Maximum operating frequency | Operations/h | | 50 | 50 | 50 | 50 | |
| Climatic proofing | | | Damp heat, constant, to IEC 60068-2-78; Damp heat, cyclical, to IEC 60068-2-30 | | | | |
| Ambient temperature | | | | | | | |
| Open | | [°C / °F] | -25...50 °C / -13...122 °F | -25...50 °C / -13...122 °F | -25...50 °C / -13...122 °F | -25...50 °C / -13...122 °F | |
| Enclosed | | [°C / °F] | -25...40 °C / -13...104 °F | -25...40 °C / -13...104 °F | -25...40 °C / -13...104 °F | -25...40 °C / -13...104 °F | |
| Mounting position | | | As required | | | | |
| Mechanical shock-resistance (IEC/EN 60068-2-27) | | | | | | | |
| Half-sinusoidal shock, 20 ms | | | [g] | 15 | 15 | 15 | 15 |
| Contacts | | | | | | | |
| Rated operational voltage | U_e | [V AC] | 690 | 690 | 690 | 690 | |
| Rated impulse withstand voltage | U_{imp} | [V AC] | 6000 | 6000 | 6000 | 6000 | |
| Overvoltage category/pollution degree | | | III/3 | | | | |
| Rated uninterrupted current (UL) | I_u | [A] | 25 | 32 | 63 | 100 | |
| Load rating with intermittent operation, class 12 | | | | | | | |
| AB 60 % DF | | [x I_e] | 1.3 | 1.3 | 1.3 | 1.3 | |
| AB 40 % DF | | [x I_e] | 1.6 | 1.6 | 1.6 | 1.6 | |
| AB 25 % DF | | [x I_e] | 2 | 2 | 2 | 2 | |
| Short-circuit rating | Fuse | [A gG/gL] | 25 | 50 | 80 | 100 | |
| Rated short-time withstand current (1 s current) | I_{cw} | [A _{rms}] | 640 | 640 | 1260 | 2000 | |
| Isolating characteristics to IEC/EN 60947 | | | [V AC] 690 | | | | |
| Safe isolation to VDE 0106 Part 101 and Part 101/A1 | | | | | | | |
| Between auxiliary contacts and main contacts | | | [V AC] 440 | | | | |
| Switching angles | | | [°] 90 | | | | |
| Contact units | | | max. 3(+N) | | | | |
| Current heat loss per contact at I_e | | | [W] 1.1, 1.8, 4.5, 7.5 | | | | |
| Terminal Capacities | | | | | | | |
| Solid or stranded | | | [mm ²] | | | | |
| | | | 1 x (1.5 – 6) | | | | |
| | | | 2 x (1.5 – 6) | | | | |
| Flexible with ferrule to DIN 46228 | | | [mm ²] | | | | |
| | | | 1 x (1 – 4) | | | | |
| | | | 2 x (1 – 4) | | | | |
| | | | 1 x (1.5 – 25) | | | | |
| | | | 2 x (1.5 – 6) | | | | |
| Terminal screw | | | M4, M5 | | | | |
| Tightening torque | | | [Nm] 1.6, 3 | | | | |

| Rotary Switches | | | | P1-25... | P1-32... | P3-63... | P3-100... | |
|--|---------------------------------|------------|----|----------|----------|----------|-----------|-----|
| Switching Capacity (IEC only) | | | | | | | | |
| AC | | | | | | | | |
| Rated making capacity $\cos \varphi = 0.35$ | | | | [A] | 240 | 320 | 800 | 950 |
| Rated breaking capacity, motor load switch $\cos \varphi = 0.35$ | | | | | | | | |
| 230V | | | | [A] | 190 | 260 | 640 | 760 |
| 400V | | | | [A] | 150 | 300 | 640 | 740 |
| 500V | | | | [A] | 170 | 290 | 590 | 880 |
| 690V | | | | [A] | 150 | 250 | 340 | 520 |
| AC-21A Rated operational current load-break switch | | | | | | | | |
| 440V I_e | | | | [kW] | 25 | 32 | 63 | 100 |
| AC-3 motor load switch motor rating | | | | | | | | |
| 230V P | | | | [kW] | 5.5 | 7.5 | 15 | 22 |
| 400/415V P | | | | [kW] | 7.5 | 13 | 30 | 37 |
| 500V P | | | | [kW] | 7.5 | 18.5 | 30 | 45 |
| 690V P | | | | [kW] | 7.5 | 15 | 30 | 37 |
| AC-23A motor load switches (main switches, maintenance switches) | | | | | | | | |
| 230V P | | | | [kW] | 7 | 8.5 | 18.5 | 45 |
| 400/415V P | | | | [kW] | 13 | 15 | 37 | 37 |
| 500V P | | | | [kW] | 11 | 18.5 | 37 | 30 |
| 690V P | | | | [kW] | 11 | 18.5 | 30 | 50 |
| DC | | | | | | | | |
| DC-1, load-break switches L/R = 1 ms | | | | | | | | |
| Rated operational current I_e | | | | [A] | 25 | 32 | 63 | 65 |
| Voltage per contact pair in series | | | | [V] | 60 | 60 | 60 | 45 |
| DC-23A, motor load switch L/R = 15 ms | | | | | | | | |
| 24V | Rated operational current I_e | [A] | 25 | 25 | 50 | 100 | | |
| | Contacts | [Quantity] | 1 | 1 | 1 | 60 | | |
| 48V | Rated operational current I_e | [A] | 25 | 25 | 50 | 50 | | |
| | Contacts | [Quantity] | 2 | 2 | 2 | 1 | | |
| 60V | Rated operational current I_e | [A] | 25 | 25 | 50 | 50 | | |
| | Contacts | [Quantity] | 3 | 3 | 3 | 3 | | |
| 120V | Rated operational current I_e | [A] | 12 | 12 | 25 | 25 | | |
| | Contacts | [Quantity] | 3 | 3 | 3 | 3 | | |

**P1-... Rotary Switches
Flush Mounting**

Dimensions are in millimeters.
Not intended for manufacturing purposes.

Standard size handle
P1-.../E

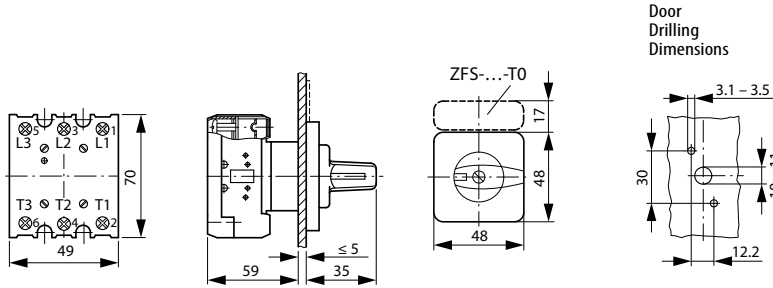

Padlockable size handle
P1-.../EA/SVB-SW
P1-.../EA/SVB

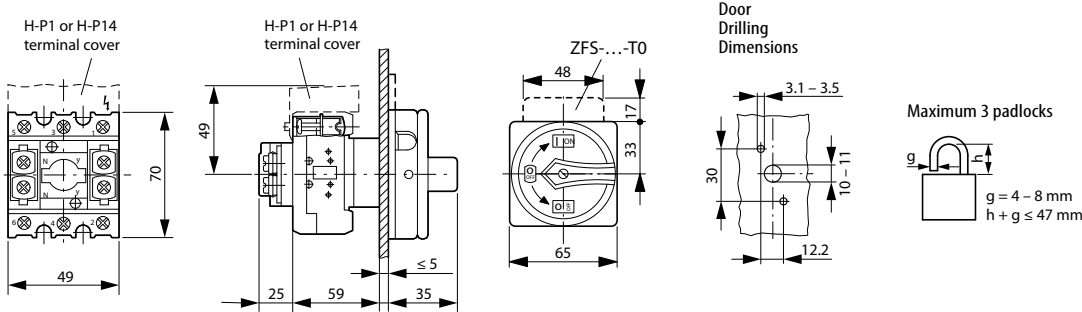

**P1-... Rotary Switches
Base Mounting**

Standard size handle
P1-.../Z

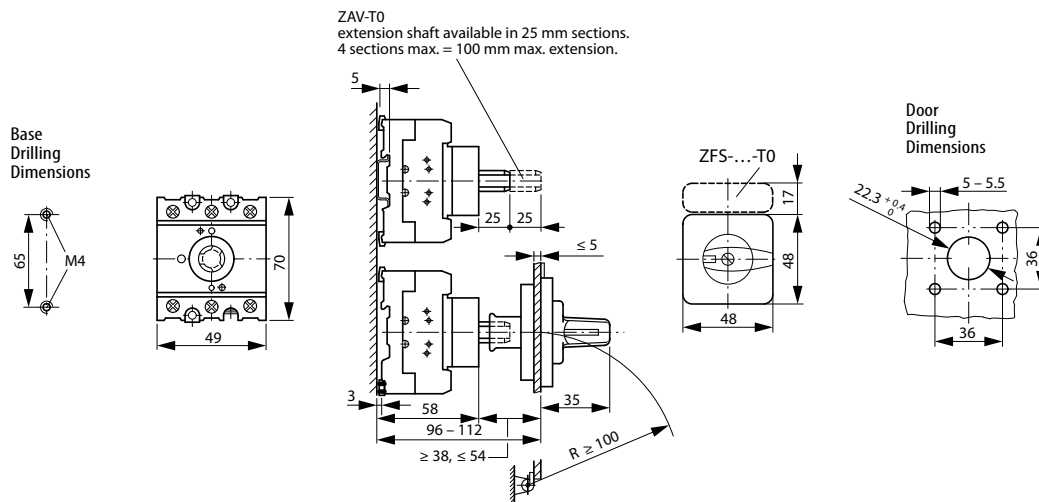

Rotary Switches