

PLUGMOLD® NM2000 SERIES™



Two-piece, single channel raceway. Easy-to-install and ideal for basic power or communication installations.

CODE REFERENCE

cULus Listed Base & Blank Cover:
File E4376 Guide RJBT.

Multioutlet Assemblies:
File E15191 Guide PVGT.

Fittings:
File E41751 Guide RJPR.

Base and Blank Cover and Plugmold Series with Snapicoil Harness:
Meets Article 386 of NEC.
Meets Section 12-3032 of CEC.

Plugmold Wired Sections:
Meets Article 380 of NEC.
Meets Section 12-3032 of CEC.

Plugmold NM2000 Series System Layout

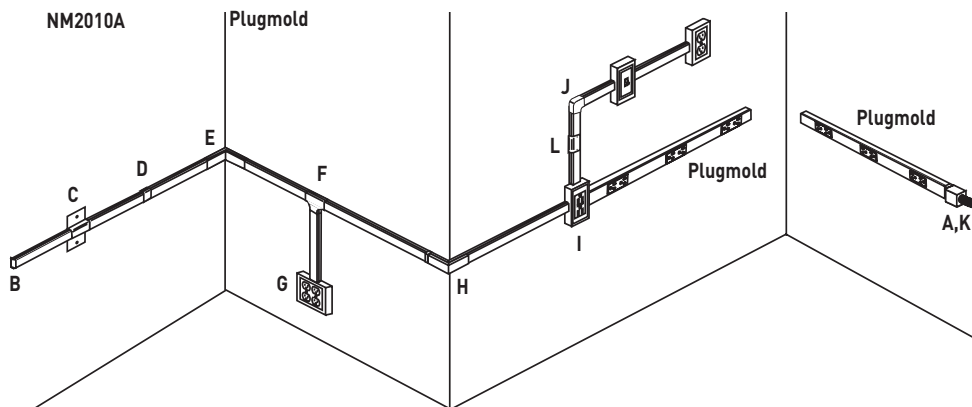

NOTE: Illustration is for showing product applications only.

KEY

- A. NM2010A Entrance End Fitting
- B. NM2010B Blank End Fitting
- C. NM2051H Horizontal Wall Box Adapter
- D. NM2006 Cover Clip
- E. NM2017 Internal Elbow
- F. NM2015 Tee Fitting
- G. NM2048-2 Two-Gang Device Box
- H. NM2018 External Elbow
- I. NM2048 Single-Gang Device Box
- J. NM2011 Flat Elbow
- K. NM2010A Entrance End Fitting
- L. NM2051V Vertical Wall Box Adapter Plugmold Plus Multioutlet System

COLOR OPTIONS



Plugmold® Plus NM2000 Series™ Part Numbers without a prefix have an ivory finish unless otherwise specified.

Custom color options are also available. Consult the factory for more information.

PLUGMOLD® NM2000 SERIES™

Plugmold NM2000 Series Ordering Information (continued)

NM2015 Tee

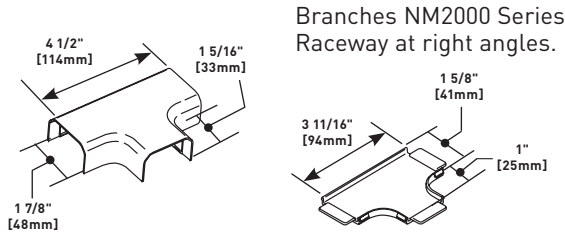

NM2048 and NM2048-2 Sure-Snap® Deep Device Box

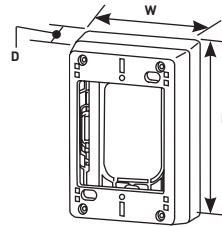

Cover snaps onto base – no screws required. Cover has twistouts on all sides. Rectangular KO in base for extension to wall box.

NM2017 Internal Elbow

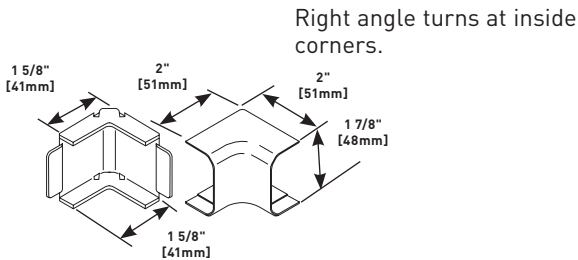

CAT NO.	L	W	D	GANG
NM2048	4 3/4" [121mm]	3" [76mm]	1 3/4" [44mm]	1
NM2048-2	4 3/4" [121mm]	4 7/8" [124mm]	1 3/4" [44mm]	2

NM2051H Horizontal Wall Box Adapter

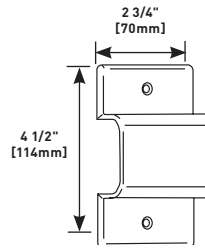

Feeds NM2000 Series Raceway from an existing wall outlet for horizontal applications. Provides complete access to wall box for connections.

NM2018 External Elbow

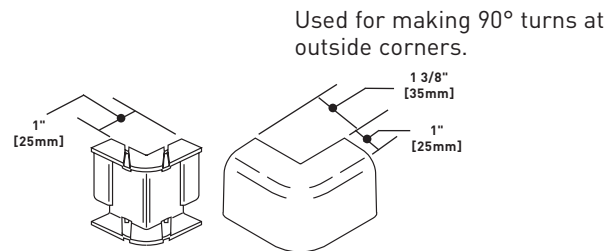

NM2051V Vertical Wall Box Adapter

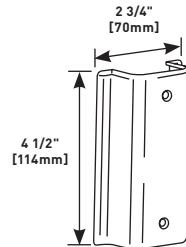

Feeds NM2000 Series Raceway from an existing wall outlet for vertical applications. Provides complete access to wall box for connections.

NM2044 , NM2044-2 Extra Deep Device Box

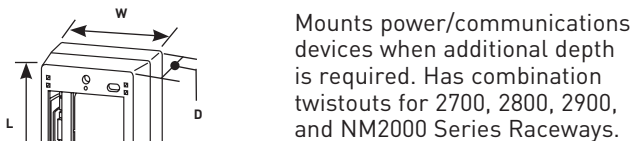

CAT NO.	L	W	D	GANG
NM2044	4 3/4" [121mm]	3" [76mm]	2 3/4" [70mm]	1
NM2044-2	4 3/4" [121mm]	4 7/8" [124mm]	2 3/4" [70mm]	2

NM2027-15 , NM2027-20 Replacement Receptacle

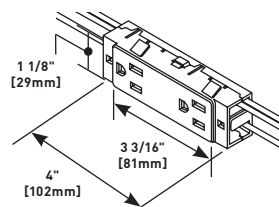

15 and 20A replacement devices. 6" [152mm] wire leads each side.