



SmartMate

SMARTMATE ELE BALLAST (3) 40W CFL (4-PIN) 120-277V

Offering maximum versatility, the Philips Advance family of SmartMate ballasts for 4-pin compact fluorescent lamps drive a broad range of quad and triple-tube, circline, 2D, and long twin-tube lamps. SmartMate ballasts' energy efficient design, compact and lightweight housing, and user-friendly features make these ballasts an ideal choice for fixture manufacturers, retrofitters, and MRO replacement.

Product data

General Information		Rated Lamp Power	40 W
Lamp Type	FT40W/2G11	Wiring	
Number of Lamps	2/3 piece/unit	Color Input Terminals	No terminals
Ballast Type	Electronic Fluorescent	Color Output Terminals	No terminals
Base Model	ICN3TTP40SC	Wire Striplength	0.50/0.375 mm
Suitable For Outdoor Use	Yes	Lamp Connection	Parallel
Automatic Restart	Yes	Wire Length by Color	See data sheet
Operating and Electrical		Wire Gauge (Nom)	18AWG mm
Input Voltage	120 to 277 V	Wire Type	Solid
Input Frequency	50 to 60 Hz	Remote Wiring Configuration Allowed	Yes
Total Harmonic Distortion USA	10 %	Tandem Wiring Configuration Allowed	Yes
Ignition Method	Instant Start	Through Wiring Configuration Allowed	Yes
Crestfactor (Nom)	1.7	Max Ballast-Lamp Distance Remote Wiring	20'
Ignition Time (Nom)	0.1 s	Max Ballast-Lamp Distance Tandem Wiring	Any = 20'
Ballast Factor (Nom)	0.88	Max Ballast-Lamp Distance Through Wiring	Any = 20'
Power Factor (Nom)	0.98	Connector Type	No connector
Input Current (Max)	0.83 A	Temperature	
Input Current (Min)	0.35 A	T-Case Maximum (Nom)	70 °C
Input Power (Nom)	99-97 W		

Mechanical and Housing

Housing Material	Metal
Housing	SC
Housing Dimensions	9.5" x 1.7" x 1.18"

Approval and Application

EMC Immunity Standard	FCC Non-Consumer
Approval Marks	CSA certificate UL certificate CEC Listing RoHS Compliant
Hum And Noise Level	A
UL Recognized	No

Product Data

Order product name	SMARTMATE ELE BALLAST (3) 40W CFL (4-PIN) 120-277V
EAN/UPC - Product	781087065099
Order code	913710835402
Numerator - Quantity Per Pack	1
Numerator - Packs per outer box	20
Material Nr. (12NC)	913710835402
Net Weight (Piece)	0.577 kg

Dimensional drawing

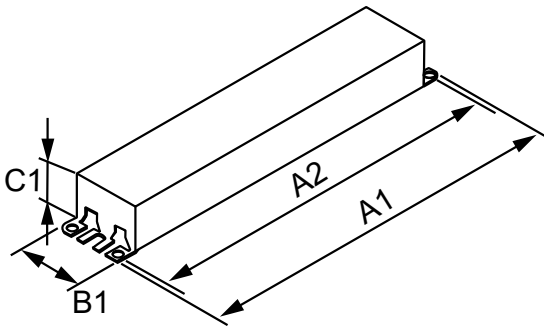

ELE BALLAST (3) 40W CFL (4-PIN) 120-277V

Product	A1	A2	B1	C1
SMARTMATE ELE BALLAST (3) 40W CFL (4-PIN) 120-277V	9.5 in	8.90 in	1.7 in	1.18 in

