



SIEMENS



SETRON • SIVACON • ALPHA

Low-Voltage Power Distribution and Electrical Installation Technology

Fuse Systems

Catalog
Extract
LV 10

Edition
10/2018

[siemens.com/lowvoltage](https://www.siemens.com/lowvoltage)

Related catalogs

Low-Voltage Power Distribution and Electrical Installation Technology LV 10
 SENTRON • SIVACON • ALPHA
 Protection, Switching, Measuring and Monitoring Devices, Switchboards and Distribution Systems

PDF (E86060-K8280-A101-A8-7600)
 Print (E86060-K8280-A101-A6-7600)



Air Circuit Breakers and Molded Case Circuit Breakers with UL Certification LV 18
 SENTRON

PDF (E86060-K8280-E347-A1-7600)



Industrial Controls IC 10
 SIRIUS

PDF (E86060-K1010-A101-A9-7600)



Industrial Communication IK PI
 SIMATIC NET

E86060-K6710-A101-B8-7600



DELTA ET D1
 Switches and Socket Outlets

PDF



SITRAIN
 Training for Industry

www.siemens.com/sitrain



Catalog PDF / Contact

Catalog PDF

Digital versions of the catalogs are available in the Siemens Industry Online Support.

www.siemens.com/lowvoltage/catalogs



Contact

Your personal contact can be found in our Contacts Database at:

www.siemens.com/automation-contact



Industry Mall / TIA ST / CA 01

Industry Mall

Information and Ordering Platform on the Internet:

www.siemens.com/industrymall



Siemens TIA Selection Tool

for the selection, configuration and ordering of TIA products and devices

www.siemens.com/tst



Products for Automation and Drives CA 01

Interactive Catalog Download

www.siemens.com/ca01download



Trademarks

All product designations may be registered trademarks or product names of Siemens AG or other supplying companies. Third parties using these trademarks or product names for their own purposes may infringe upon the rights of the trademark owners. Further information about low-voltage power distribution and electrical installation technology is available on the Internet at:

www.siemens.com/lowvoltage

Technical Support

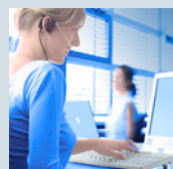

Expert advice on technical questions with a wide range of demand-optimized services for all our products and systems.

www.siemens.com/lowvoltage/support-request

Low-Voltage Power Distribution and Electrical Installation Technology

Protection, Switching, Measuring and Monitoring Devices, Switchboards and Distribution Systems

SENTRON · SIVACON · ALPHA

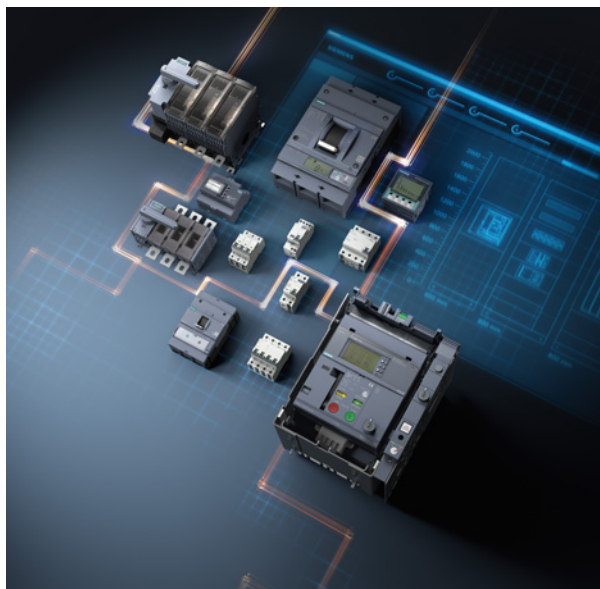

Catalog LV 10 · 10/2018

Supersedes:
Catalog LV 10 · 04/2018

Refer to the Industry Mall for current updates of
this catalog:
www.siemens.com/industrymall

The products in this catalog can also be found in the
Interactive Catalog CA 01.
Article No.: E86060-D4001-A510-D8-7500

Please contact your local Siemens branch.

© Siemens AG 2019

The products and systems listed in this
catalog are developed and manufactured
using a certified quality management system
in accordance with EN ISO 9001:2008.

Protection, Switching, Measuring and Monitoring Devices

Air Circuit Breakers	1
Molded Case Circuit Breakers	2
Miniature Circuit Breakers	3
Residual Current Protective Devices / Arc Fault Detection Devices (AFDDs)	4
Fuse Systems	5
Overvoltage Protection Devices	6
Switch Disconnectors	7
Transfer Switching Equipment and Load Transfer Switches	8
Switching Devices	9
Transformers, Power Supply Units and Socket Outlets	10
Busbar Systems	11
Measuring Devices and Power Monitoring	12
Monitoring Devices	13
Terminal Blocks	14
Software	15
Switchboards	16
Busbar Trunking Systems	17
System Cubicles, System Lighting and System Air-Conditioning	18
Power Distribution Boards / Distribution Boards	19
Appendix	20

Switchboards and Distribution Systems

Opening information

Ordering notes

Overview

Ordering special versions

When ordering products that differ from the standard versions listed in the catalog, "-Z" must be added to the Article No. indicated and the required features must be specified using alphanumeric order codes or plain text.

Ordering very small quantities

When very small orders are placed, the costs associated with order processing are greater than the order value. We therefore recommend that you combine several small orders. Where this is not possible, we regret that we are obliged to make a small processing charge: for orders with a net goods value of less than € 250 we charge a € 20 supplement to cover our order processing and invoicing costs.

Explanations of Selection and ordering data

Standard delivery time (SD)

- ▶ Preferred type Preferred types are device types that can be delivered immediately ex works, i.e. they are dispatched within 24 hours.

Price units (PU)

The price unit defines the number of units, sets or meters to which the specified price applies.

Packaging size (PS)

The packaging size defines the number of units, sets or meters, for example, for outer packaging. Only the quantity defined by the packaging size or a multiple thereof can be ordered.

Price group (PG)

Each product is allocated to a price group.

Example

5TT3400
SD: Preferred type
PG: 13C
Ordering quantity 1 unit or a multiple thereof

8US1923-5CA02
PG: 14O
Ordering quantity 10 units or a multiple thereof

8WH9000-1GA00
PG: 12X
Ordering quantity 50 units or a multiple thereof

SD	Article No.	Price per PU	PU (UNIT, SET, M)	PS*	PG
d					
▶	5TT3400		1	1 unit	1BK
	8US1923-5CA02		1	10 units	1CU
	8WH9000-1GA00		100	50 units	1BT

Note:

The article numbers shown here and the specifications regarding selection and ordering data are examples only. When ordering, always use the selection and ordering data in the product chapters.

Metal surcharges/export markings

To compensate fluctuating prices of raw materials (for example silver, copper, aluminum, lead, gold, dysprosium and neodymium), surcharges are calculated on a daily basis for products containing these raw materials using the metal factor. A surcharge for the particular raw material is added to the price of a product if the basic quotations for this raw material are exceeded.

Each product's metal factor dictates for which raw materials the metal surcharges are calculated, from which quotation and with which calculation method (weight or percentage method).

An exact explanation of the metal factor can be found at: www.siemens.com/automation/salesmaterial-as/catalog/en/terms_of_trade_en.pdf

A product's export markings/metal surcharges are updated daily at www.siemens.com/industrymall.



5/2	Introduction
	NEOZED fuse systems
5/4	Introduction
5/7	NEOZED fuse links
5/8	MINIZED switch disconnectors and MINIZED fuse switch disconnectors
5/9	NEOZED fuse bases and accessories
5/12	DIAZED fuse systems
	Cylindrical fuse systems
5/18	Cylindrical fuse links and cylindrical fuse holders
5/22	Fuse holders in size 10 x 38 mm and Class CC
	Fuse systems acc. to UL
5/26	Class CC fuse systems
5/29	Class J fuse systems
5/31	Busbar systems
	3NA, 3ND LV HRC fuse systems
5/37	LV HRC fuse links
5/46	LV HRC signal detectors
5/48	LV HRC fuse bases and accessories
	SITOR semiconductor fuses
5/56	LV HRC design
5/66	Cylindrical fuse design
5/70	NEOZED, DIAZED design
	Photovoltaic fuses
5/72	Introduction
5/73	PV cylindrical fuses
5/75	PV cumulative fuses

For further technical product information:

[Configuration Manual](#)

[Fuse Systems](#)

Article No.: 3ZW1012-3NW10-0AC1

Siemens Industry Online Support:







www.siemens.com/lowvoltage/product-support









→ Entry type:
 Application example
 Certificate
 Characteristic
 Download
 FAQ
 Manual
 Product note
 Software archive
 Technical data

Fuse Systems

Introduction

Overview

Devices	Page	Application	Standards	Used in		
				Non-residential buildings	Residential buildings	Industry
 <p>NEOZED fuse systems</p>	5/4	MINIZED switch disconnectors, bases, fuse links from 2 A to 63 A of operational class gG and accessories. Everything you need for a complete system.	Fuse system: IEC 60269-3; DIN VDE 0636-3 Fuse switching devices: IEC/EN 60947-3 DIN VDE 0638; EN 60947-3 (VDE 0660-107)	✓	✓	✓
 <p>DIAZED fuse systems</p>	5/12	Fuse links from 2 A to 100 A in various operational classes, base versions with classic screw base connections. A widely used fuse system.	IEC 60269-3; DIN VDE 0635; DIN VDE 0636-3; CEE 16	✓	✓	✓
Cylindrical fuse systems						
 <p>Cylindrical fuse links and cylindrical fuse holders</p>	5/18	Line protection or protection of switching devices. The fuse holders with touch protection ensure the safe "no-voltage" replacement of fuse links. Auxiliary switches can be retrofitted.	IEC 60269-1, -2, -3; NF C 60-200; NF C 63-210, -211; NBN C 63269-2, CEI 32-4, -12 Fuse holders: File No. E171267	✓	✓	✓
 <p>Fuse holders in size 10 x 38 mm and Class CC</p>	5/22	For installing fused loaded motor starter combinations.	IEC 60269-1,-2; IEC 60947-4; UL 4248-1, File No. E171267 CSA 250269, 6225-01 Auxiliary switches: UL 508, File No. E334003	✓	--	✓
 <p>Class CC and Class J fuse systems</p>	5/26	Class CC and Class J comply with the American standard and have UL and CSA approval, for customers exporting OEM products and machine builders. Modern design with touch protection according to BGV A3 for use in "branch circuit protection".	Fuse holders: UL 4248-1, E171267 CSA 22.2 Fuse links: UL 248-4, File No. E258218, CSA 231237, 1422-02 and 1422-82	✓	✓	✓
 <p>Busbar systems</p>	5/31	Busbars for NEOZED fuse bases, NEOZED fuse disconnectors, MINIZED switch disconnectors, DIAZED fuse systems and for the cylindrical fuse systems. Compact cylindrical fuse holders for busbars	EN 60439-1 (VDE 0660-500) UL 4248-1, E337131	✓	✓	✓

Devices	Page	Application	Standards	Used in			
				Non-residential buildings	Residential buildings	Industry	
3NA, 3ND LV HRC fuse systems							
	LV HRC fuse links	5/37	Fuse links from 2 A to 1250 A for selective line protection and system protection in non-residential buildings, industry and power utilities.	IEC 60269-1, -2; EN 60269-1; DIN VDE 0636-2; CSA 16325 - 1422-02	✓	✓	✓
	LV HRC signal detectors	5/46	Signal detectors for when a fuse is tripped on all LV HRC fuse links with combination or front indicators with non-insulated grip lugs. Plus the comprehensive accessory range required for LV HRC fuse systems.	--	✓	✓	✓
	LV HRC fuse bases and accessories	5/48	Fuse bases for screw or snap-on mounting onto standard mounting rails, available as 1-pole or 3-pole version.	IEC 60269-1, -2; EN 60269-1; DIN VDE 0636-2 UL 4248-1, File No. E171267-IZLT2 (only downstream from branch circuit protection) CSA C22.2 No. 4248.1-07	✓	✓	✓
SITOR semiconductor fuses							
	LV HRC design	5/56	Fuse links in LV HRC design and a huge variety of models support a wide range of applications from 500 V to 1500 V and 150 A to 1600 A. Fuses with slotted blade contacts, bolt-on links or female thread and special designs.	UL 4248-13, File No. E167357-JFHR2	--	--	✓
	Cylindrical fuse design	5/66	Fuse links, fuse holders – usable as fuse switch disconnectors and fuse bases up to 600/690 V AC and 400/700 V DC from 1 A to 100 A in the sizes 10 x 38 mm, 14 x 51 mm and 22 x 58 mm.	Fuse links: UL 4248-13, File No. E167357-JFHR2 CSA 248170, 1422-30 Fuse holders: UL 4248-1, File No. E171267-IZLT CSA 248170, 6225-01	--	--	✓
	NEOZED, DIAZED design	5/70	NEOZED fuse links for 400 V AC and 250 V DC and DIAZED for 500 V AC and 500 V DC.	--	--	--	✓
Photovoltaic fuses							
	PV cylindrical fuses	5/73	Fuses with a rated voltage of 1000 V and 1500 V DC and gPV operational class for the protection of photovoltaic modules, their connecting cables and other components.	IEC 60269-6	✓	✓	✓
	PV cumulative fuses	5/75	Fuses with a rated voltage of 1000 V and 1500 V DC, a rated current of 63 A to 630 A and operational class gPV for the protection of connecting cables and other components.	IEC60269-6	✓	✓	✓

Fuse Systems

NEOZED Fuse Systems

Introduction

Overview

The NEOZED fuse system is primarily used in distribution technology and industrial switchboard assemblies. The system is easy to use and is also approved for domestic installation.

The MINIZED switch disconnectors are primarily used in switchboard assemblies and control engineering. They are approved for switching loads as well as for safe switching in the event of short circuits. The MINIZED D02 is also suitable for use upstream of the meter in household applications in compliance with the recommendations of the VDEW according to TAB.

Due to its compact design, the MINIZED D01 fuse switch disconnector is primarily used in control engineering.

The NEOZED fuse bases are the most cost-effective solution for using NEOZED fuses. All NEOZED bases must be fed from the bottom to ensure that the threaded ring is insulated during removal of the fuse link. The terminals of the NEOZED bases are available in different versions and designs to support the various installation methods.

Benefits

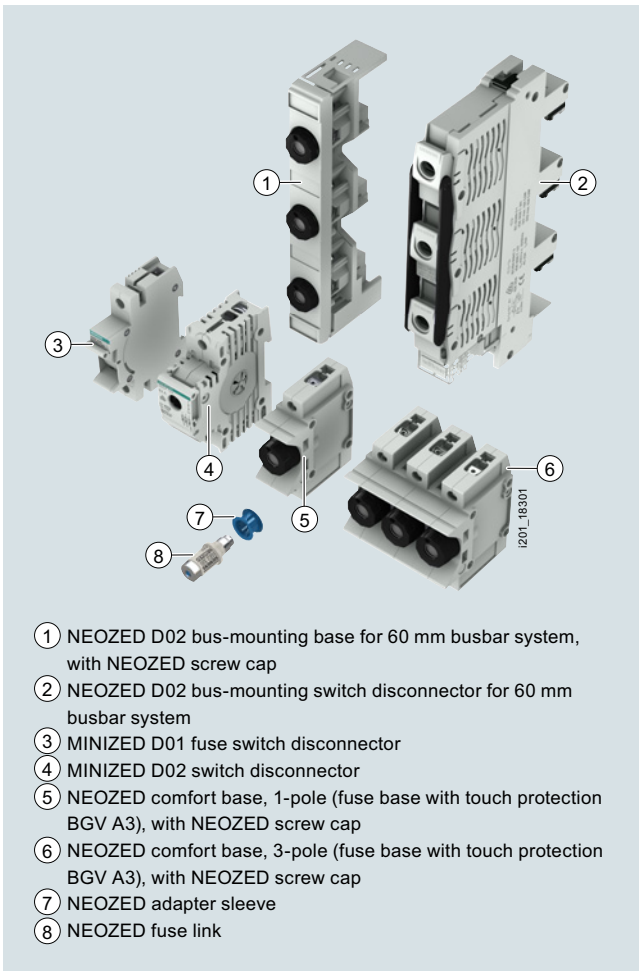

- ① NEOZED D02 bus-mounting base for 60 mm busbar system, with NEOZED screw cap
- ② NEOZED D02 bus-mounting switch disconnector for 60 mm busbar system
- ③ MINIZED D01 fuse switch disconnector
- ④ MINIZED D02 switch disconnector
- ⑤ NEOZED comfort base, 1-pole (fuse base with touch protection BGV A3), with NEOZED screw cap
- ⑥ NEOZED comfort base, 3-pole (fuse base with touch protection BGV A3), with NEOZED screw cap
- ⑦ NEOZED adapter sleeve
- ⑧ NEOZED fuse link

Compared to the older DIAZED fuse system, the NEOZED fuse system is significantly more modern:

- Much more compact which saves space in the distribution board
- Modern devices like the MINIZED switching devices, which combine the functions of a switch disconnector and a fuse base
- Wide range of accessories, such as busbars for one, two, or three-phase wiring
- Modern terminals for MINIZED D02 and NEOZED comfort bases: visible, clear and controllable connection simplifies cable entry

Double terminal chambers permit connection of two wires of different cross-sections

- Lower power loss of the fuse links

Even when compared to the internationally prevalent cylindrical fuse system, the NEOZED fuse system has considerable advantages:

- Non-interchangeability – thanks to use of adapter sleeves (i.e. it is not possible to insert a fuse for larger currents). This is a requirement of numerous wiring regulations in Germany and other European countries.
- Switching devices with load switching characteristics allow the safe switching of load currents up to 63 A.

Technical specifications

		NEOZED fuse links 5SE2								
Standards		IEC 60269-3; DIN VDE 0636-3								
Operational class		gG								
Rated voltage U_n	V AC	400								
	V DC	250								
Rated current I_n	A	2 ... 100								
Rated breaking capacity	kA AC	50								
	kA DC	8								
Non-interchangeability		Using adapter sleeves								
Resistance to climate	°C	Up to 45 at 95% rel. humidity								
Ambient temperature	°C	-5 ... +40 °C, humidity 90% at 20 °C								
		MINIZED switch disconnectors D02 5SG71	MINIZED fuse switch disconnectors D01 5SG76	Fuse bases, made of ceramic D01 5SG15 5SG55			D02 5SG16 5SG56	D03 5SG18	Comfort bases D01/02 5SG1301 5SG1701 5SG5301 5SG5701	Fuse bases D01/02 5SG1302 5SG1702 5SG5302 5SG5702
Standards		DIN VDE 0638; EN 60947-3 (VDE 0660-107) IEC/EN 60947-3		IEC 60269-3; DIN VDE 0636-3						
Main switch characteristic EN 60204-1		Yes	--	--						
Insulation characteristic EN 60664-1		Yes	--	--						
Rated voltage U_n • 1P • 2P in series	V AC	230/400, 240/415			400					
	V DC	65	48	250						
	V DC	130	110	250						
Rated current I_n	A	63	16	16	63	100	16/63	16/63		
Rated conditional short-circuit current	kA	50			--					
Rated insulation voltage	V AC	500	690	--						
Rated impulse withstand voltage	kV AC	6	6	--						
Overvoltage category		IV	IV	--						
Utilization category acc. to VDE 0638 • AC-22	A	63	16	--						
Utilization category acc. to EN 60947-3 • AC-22 A • AC-22 B • AC-23 B • DC-22 B	A	--	16	--						
	A	63	--	--						
	A	35	--	--						
	A	63	--	--						
Sealable when switched on		Yes		Yes, with sealable screw caps						
Mounting position		Any, preferably vertical								
Reduction factor of I_n with 18 pole • Side-by-side mounting • On top of one another, with vertical standard mounting rail		0.9	--							
		0.87	--							
Degree of protection acc. to IEC 60529		IP20, with connected conductors ¹⁾								
Terminals With touch protection acc. to BGV A3		Yes			No			Yes		
Ambient temperature	°C	-5 ... +40 °C, humidity 90% at 20 °C								
Terminal versions		Box terminal	Box terminal	B	K, S	K/S	Box terminal	Box terminal		
Conductor cross-sections • Solid • Solid and stranded • Flexible • Flexible, with end sleeve	mm ²									
	mm ²	1.5 ... 35	1.5 ... 16	1.5 ... 4	2.5 ... 25	10 ... 50	0.75 ... 35	Input 1 ... 35, Output 1 ... 25		
	mm ²	1.5 ... 35	1.5 ... 10	1.5 ... 4	1.5 ... 16	10 ... 35	--	Input 1.5 ... 25, Output 1 ... 25		
	mm ²	1.5 ... 35	1.5 ... 10	1.5 ... 4	1.5 ... 16	10 ... 35	--	Input 1.5 ... 25, Output 1 ... 25		
Tightening torque	Nm	2.5 ... 3	2	1.2	2	3.5/2.5	3.5	3		

¹⁾ Degree of protection IP20 is tested according to regulations using a straight test finger (from the front), with the device mounted and equipped with a cover, housing or some other enclosure.

Fuse Systems

NEOZED Fuse Systems

Introduction

More information

5

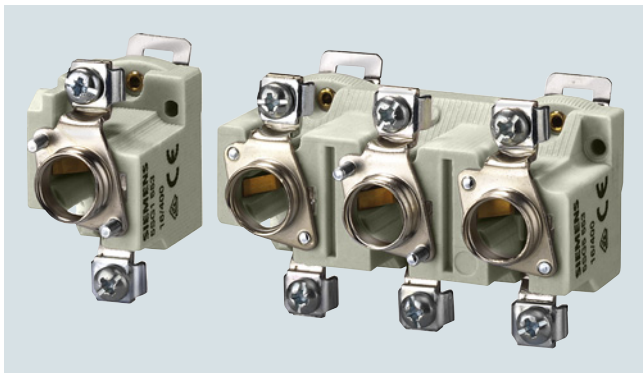

Fuse bases D01 with terminal version BB

- Incoming feeders, clamp-type terminal B
- Outgoing feeders, clamp-type terminal B



Fuse bases D02, with terminal version KS



- Incoming feeders, screw head contact K
- Outgoing feeders, saddle terminal S



Fuse bases D02, with terminal version SS

- Incoming feeders, saddle terminal S
- Outgoing feeders, saddle terminal S

Selection and ordering data

Size	I_n	Identification color	Mounting width	SD	Article No. www.siemens.com/ product?Article No.	Price per PU	PU (UNIT, SET, M)	PS	PG
	A		MW	d					
NEOZED fuse links, rated voltage 400 V AC/250 V DC, operational class gG									
	D01	2	Pink	--	▶ 5SE2302		1	10 units	1BM
		4	Brown	--	▶ 5SE2304		1	10 units	1BM
		6	Green	--	▶ 5SE2306		1	10 units	1BM
		10	Red	--	▶ 5SE2310		1	10 units	1BM
		13	Black	--	▶ 5SE2013-2A		1	10 units	1BM
		16	Gray	--	▶ 5SE2316		1	10 units	1BM
	D02	20 ¹⁾	Blue	--	▶ 5SE2320		1	10 units	1BM
		25 ¹⁾	Yellow	--	▶ 5SE2325		1	10 units	1BM
		32 ¹⁾	Violet	--	▶ 5SE2332		1	10 units	1BM
		35 ¹⁾	Black	--	▶ 5SE2335		1	10 units	1BM
		40 ²⁾	Black	--	▶ 5SE2340		1	10 units	1BM
		50 ²⁾	White	--	▶ 5SE2350		1	10 units	1BM
	D03	63 ²⁾	Copper	--	▶ 5SE2363		1	10 units	1BM
		80	Blue	--	▶ 5SE2280		1	10 units	1BM
		100	Red	--	▶ 5SE2300		1	10 units	1BM

1) With tin-coated contacts





2) With silver-plated contacts

Fuse Systems

NEOZED Fuse Systems

MINIZED switch disconnectors and MINIZED fuse switch disconnectors

Selection and ordering data





Size	Number of poles I_n	Mounting width	SD	Article No. www.siemens.com/ product?Article No.	Price per PU	PU (UNIT, SET, M)	PS	PG
	A	MW	d					
								
MINIZED switch disconnectors with fuses Using draw-out technology with touch protection to BGV A3 (adapter sleeves not included in the scope of supply) ²⁾								
D02	1P	63	1.5	5SG7113		1	1 unit	1BM
	1P+N	63	3	5SG7153		1	1 unit	1BM
	2P	63	3	5SG7123		1	1 unit	1BM
	3P	63	4.5	5SG7133		1	1 unit	1BM
	3P+N	63	6	5SG7163		1	1 unit	1BM
Versions for Austria only With permanently fitted adapter sleeves, incl. fuse link ²⁾								
D02	3P	25	4.5	5SG7133-8BA25		1	1 unit	1BM
		35		5SG7133-8BA35		1	1 unit	1BM
		50		5SG7133-8BA50		1	1 unit	1BM
								
Reducers For fuse links D01 in MINIZED D02 switch disconnectors								
				5SH5527		1	10 units	1CU
								
Auxiliary switches (AS) For MINIZED D02 switch disconnectors								
	1 NO + 1 NC		0.5	5ST3010		1	1 unit	1AD
	2 NO			5ST3011		1	1 unit	1AD
	2 NC			5ST3012		1	1 unit	1AD
Technical specifications, see chapter "Miniature Circuit Breakers" -> Additional components*								
								
Auxiliary switches (AS) with TEST button For MINIZED D02 switch disconnectors								
	1 NO + 1 NC		0.5	5ST3010-2		1	1 unit	1AD
	2 NO			5ST3011-2		1	1 unit	1AD
	2 NC			5ST3012-2		1	1 unit	1AD
Technical specifications, see chapter "Miniature Circuit Breakers" -> Additional components*								
								
MINIZED fuse switch disconnectors Using draw-out technology with touch protection acc. to BGV A3								
D01	1P	6 ¹⁾	1	5SG7611-0KK06		1	12 units	1BM
	3P	6 ¹⁾	3	5SG7631-0KK06		1	4 units	1BM
	1P	10	1	5SG7611-0KK10		1	12 units	1BM
	3P	10	3	5SG7631-0KK10		1	4 units	1BM
	1P	16	1	5SG7611-0KK16		1	12 units	1BM
	1P+N	16	2	5SG7651-0KK16		1	6 units	1BM
	2P	16	2	5SG7621-0KK16		1	6 units	1BM
	3P	16	3	5SG7631-0KK16		1	4 units	1BM
	3P+N	16	4	5SG7661-0KK16		1	3 units	1BM

¹⁾ For 2 A, 4 A, 6 A fuses.

²⁾ Do not use fuse links with nickel-plated contact caps.

For busbars, see page 5/33.

Selection and ordering data

Size	Number of poles	I_n	Terminals ¹⁾	Mounting width	SD	Article No. www.siemens.com/ product?Article No.	Price per PU	PU (UNIT, SET, M)	PS	PG	
		A		MW	d						
NEOZED comfort bases made of molded plastic											
With touch protection according to BGV A3											
	D01	1P	16	--	1.5	5SG1301		1	3 units	1BM	
	D02		63	--		5SG1701		1	3 units	1BM	
	D01	3P	16	--	4.5	5SG5301		1	1 unit	1BM	
	D02		63	--		5SG5701		1	1 unit	1BM	
NEOZED fuse bases made of molded plastic											
With touch protection according to BGV A3											
	D01	1P	16	--	1.5	5SG1302		1	15 units	1BM	
	D02		63	--	1.5	5SG1702		1	15 units	1BM	
	D01	3P	16	--	4.5	5SG5302		1	5 units	1BM	
	D02		63	--	4.5	5SG5702		1	5 units	1BM	
	With touch protection according to BGV A3, with LED signal detector ²⁾										
		D01	1P	16	--	1.5	5SG1302-1		1	15 units	1BM
	D02		63	--	1.5	5SG1702-1		1	15 units	1BM	
	D01	3P	16	--	4.5	5SG5302-1		1	5 units	1BM	
	D02		63	--	4.5	5SG5702-1		1	5 units	1BM	
NEOZED fuse bases made of ceramic											
For snap-on mounting on standard mounting rails, with cover											
	D01	1P	16	BB	1.5	5SG1553		1	6 units	1BM	
	D02		63	SS	1.5	5SG1653		1	6 units	1BM	
	D02		63	KS	1.5	5SG1693		1	6 units	1BM	
For snap-on mounting on standard mounting rails, without cover											
	D03		100	KS	2.5	5SG1812		1	10 units	1BM	
For snap-on mounting on standard mounting rails, with cover											
	D01	3P	16	BB	4.5	5SG5553		1	2 units	1BM	
	D02		63	SS	4.5	5SG5653		1	2 units	1BM	
	D02		63	KS	4.5	5SG5693		1	2 units	1BM	

¹⁾ For terminal versions, see page 5/6.

²⁾ At least 50 V AC/DC









Fuse Systems

NEOZED Fuse Systems

NEOZED fuse bases and accessories

Size	Matching cover	Mounting width MW	SD d	Article No. www.siemens.com/ product?Article No.	Price per PU	PU (UNIT, SET, M)	PS	PG
NEOZED covers								
 D03	A6	2.5		5SH5233		1	20 units	1BM

NEOZED fuse bases and accessories

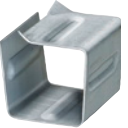
Size	For fuse links	Identification color	Mounting width	SD	Article No. www.siemens.com/ product?Article No.	Price per PU	PU (UNIT, SET, M)	PS	PG
	A		MW	d					
NEOZED screw caps									
Molded plastic, with inspection hole									
	D01				5SH4116		1	10 units	1BM
	D02				5SH4163		1	10 units	1BM
Ceramic									
	D01, sealable				5SH4316		1	20 units	1BM
	D02, sealable				5SH4363		1	20 units	1BM
	D03				5SH4100		1	10 units	1BM
Ceramic, with inspection hole									
	D01				5SH4317		1	20 units	1BM
	D02				5SH4362		1	20 units	1BM
NEOZED adapter sleeves									
	D01	2	Pink		5SH5002		1	50 units	1BM
		4	Brown		5SH5004		1	50 units	1BM
		6	Green		5SH5006		1	50 units	1BM
		10/13	Red		5SH5010		1	50 units	1BM
	D02	20	Blue		5SH5020		1	50 units	1BM
		25	Yellow		5SH5025		1	50 units	1BM
		32	Violet		5SH5032		1	50 units	1BM
		35/40	Black		5SH5035		1	50 units	1BM
		50	White		5SH5050		1	50 units	1BM
	D03	80	Silver		5SH5080		1	25 units	1BM
For fuse links D01 in base D02 and MINIZED D02 switch disconnectors									
	D02	2	Pink		5SH5402		1	10 units	1BM
		4	Brown		5SH5404		1	10 units	1BM
		6	Green		5SH5406		1	10 units	1BM
		10/13	Red		5SH5410		1	10 units	1BM
		16	Gray		5SH5416		1	10 units	1BM
NEOZED adapter sleeve fitters									
					5SH5100		1	1 unit	1BM
NEOZED retaining springs									
For fuse links D01 in screw caps									
	D02	2 ... 16			5SH5400		1	25 units	1BM

Fuse Systems

DIAZED fuse systems

Overview

The DIAZED fuse system is one of the oldest fuse systems in the world. It was developed by Siemens as far back as 1906. It is still the standard fuse system in many countries to this day. It is particularly widely used in the harsh environments of industrial applications.

The series are available with rated voltages from 500 V to 750 V.

All DIAZED bases must be fed from the bottom to ensure an insulated threaded ring when the fuse link is being removed. Reliable contact of the fuse links is only ensured when used together with DIAZED screw adapters.

The terminals of the DIAZED bases are available in different versions and designs to support the various installation methods.

The high-performing EZR bus-mounting system for screw fixing is an outstanding feature. The busbars, which are particularly suited for bus-mounting bases, have a load capacity of up to 150 A with lateral infeed.

DIAZED stands for **D**iametral gestuftes **z**weiteiliges **S**icherungssystem mit **E**disonsgewinde (diametral two-step fuse system with Edison screw).

Benefits

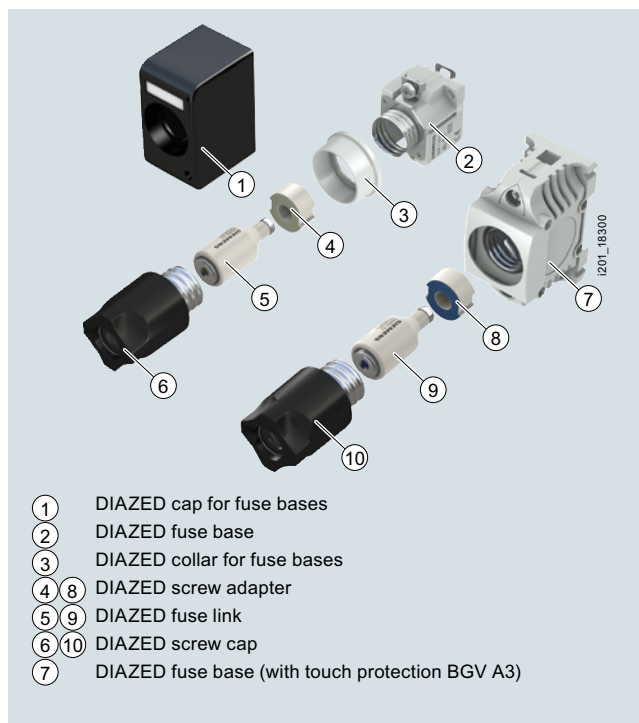

- ① DIAZED cap for fuse bases
- ② DIAZED fuse base
- ③ DIAZED collar for fuse bases
- ④ ⑧ DIAZED screw adapter
- ⑤ ⑨ DIAZED fuse link
- ⑥ ⑩ DIAZED screw cap
- ⑦ DIAZED fuse base (with touch protection BGV A3)





Technical specifications

			5SA, 5SB, 5SC, 5SD, 5SF
Standards			IEC 60269-3; DIN VDE 0635; DIN VDE 0636-3; CEE 16
Operational class	Acc. to IEC 60269; DIN VDE 0636		gG
Characteristic	Acc. to DIN VDE 0635		Slow and quick
Rated voltage U_n		V AC V DC	500, 690, 750 500, 600, 750
Rated current I_n		A	2 ... 100
Rated breaking capacity		kA AC kA DC	50, 40 at E16 8, 1.6 at E16
Overvoltage category			III II (DIAZED fuse bases made of molded plastic for use at 690 V AC/600 V DC)
Mounting position			Any, preferably vertical
Non-interchangeability			Using screw adapter or adapter sleeves
Degree of protection	Acc. to IEC 60529		IP20, with connected conductors ¹⁾
Resistance to climate		°C	Up to 45, at 95% rel. humidity
Ambient temperature		°C	-5 ... +40 °C, humidity 90% at 20 °C

¹⁾ Degree of protection IP20 is tested according to regulations using a straight test finger (from the front), with the device mounted and equipped with a cover, housing or some other enclosure.



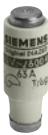

		Terminal version					
		B	K		R		
		DII	DIII	DIII	DIII	DII	DIII
Size							
Conductor cross-sections							
• Rigid, min.	mm ²	1.5	2.5	2.5	2.5	1.5	1.5
• Rigid, max.	mm ²	10	25	25	25	35	35
• Flexible, with end sleeve	mm ²	10	25	25	25	35	35
Tightening torque							
• Screw M4	Nm	1.2				--	
• Screw M5	Nm	2.0				--	
• Screw M6	Nm	2.5				3.0	
• Screw M8	Nm	3.5				--	

Selection and ordering data

Size	U_n V AC/V DC	I_n A	Identification color	Thread	SD d	Article No. www.siemens.com/ product?Article No.	Price per PU	PU (UNIT, SET, M)	PS	PG
DIAZED fuse links										
Operational class gG										
	DII	500/500	2	Pink	E27	5SB211		1	25 units	1BM
			4	Brown		5SB221		1	25 units	1BM
			6	Green		5SB231		1	25 units	1BM
			10	Red		5SB251		1	25 units	1BM
			16	Gray		5SB261		1	25 units	1BM
			20	Blue		5SB271		1	25 units	1BM
			25	Yellow		5SB281		1	25 units	1BM
	DIII	500/500	32	Violet	E33	5SB4010		1	25 units	1BM
			35	Black		5SB411		1	25 units	1BM
			50	White		5SB421		1	25 units	1BM
			63	Copper		5SB431		1	25 units	1BM
	DIV	500/400	80	Silver	R1¼"	5SC211		1	3 units	1BM
			100	Red		5SC221		1	3 units	1BM
Characteristic: slow										
	TNDz	500/500	2	Pink	E16	5SA211		1	10 units	1BM
			4	Brown		5SA221		1	10 units	1BM
			6	Green		5SA231		1	10 units	1BM
			10	Red		5SA251		1	10 units	1BM
			16	Gray		5SA261		1	10 units	1BM
			20	Blue		5SA271		1	10 units	1BM
			25	Yellow		5SA281		1	10 units	1BM
For operational class gG, use 5SF1 and 5SF5 fuse base made of ceramic										
For 2 A ... 25 A, use screw adapter DII										
	DIII	690/600	2	Pink	E33	5SD8002		1	5 units	1BM
			4	Brown		5SD8004		1	5 units	1BM
			6	Green		5SD8006		1	5 units	1BM
			10	Red		5SD8010		1	5 units	1BM
			16	Gray		5SD8016		1	5 units	1BM
			20	Blue		5SD8020		1	5 units	1BM
			25	Yellow		5SD8025		1	5 units	1BM
			35	Black		5SD8035		1	5 units	1BM
			50	White		5SD8050		1	5 units	1BM
			63	Copper		5SD8063		1	5 units	1BM

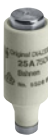
Fuse Systems





DIAZED fuse systems

Size	U_n	I_n	Identification color	Thread	Terminals	SD	Article No. www.siemens.com/ product?Article No.	Price per PU	PU (UNIT, SET, M)	PS	PG
	V AC/V DC	A				d					
DIAZED fuse links											
Characteristic: quick, also for direct current railway facilities											
For 2 A ... 25 A, use screw adapter DII											
	DIII	750/750	2	Pink	E33		5SD601		1	5 units	1BM
			4	Brown			5SD602		1	5 units	1BM
			6	Green			5SD603		1	5 units	1BM
			10	Red			5SD604		1	5 units	1BM
			16	Gray			5SD605		1	5 units	1BM
			20	Blue			5SD606		1	5 units	1BM
			25	Yellow			5SD607		1	5 units	1BM
			35	Black			5SD608		1	5 units	1BM
			50	White			5SD610		1	5 units	1BM
			63	Copper			5SD611		1	5 units	1BM
DIAZED fuse bases made of ceramic											
1P, for standard mounting rail											
	DII	500/500	25		E27	BB ²⁾	5SF1005		1	5 units	1BM
	DIII ¹⁾		63		E33	BS ²⁾	5SF1205		1	5 units	1BM
DIAZED fuse bases made of molded plastic											
With touch protection according to BGV A3											
1P, for standard mounting rail or screw fixing											
	DII	500/500	25		E27	RR	5SF1060		1	3 units	1BM
	DIII ¹⁾		63		E33	RR	5SF1260		1	3 units	1BM
3P, for standard mounting rail or screw fixing											
	DII	500/500	25		E27	RR	5SF5068		1	1 unit	1BM
	DIII ¹⁾		63		E33	RR	5SF5268		1	1 unit	1BM

¹⁾ Also for 690 V AC/600 V DC. For overvoltage category, see page 5/12.

²⁾ For terminal versions, see page 5/17.







DIAZED fuse systems

	Size	U_n	I_n	Thread	Terminals	SD	Article No. www.siemens.com/ product?Article.No.	Price per PU	PU (UNIT, SET, M)	PS	PG	
		V AC/V DC	A			d						
DIAZED components 750 V												
	DIAZED fuse bases 1P, for screw fixing With fine thread and cap											
	DIII	750/750	63	E33S	KK ¹⁾		5SF4230		1	1 unit	1BM	
	DIAZED screw caps Made of ceramic, with fine thread											
	DIII	750/750	63	E33S			5SH1161		1	5 units	1BM	
DIAZED screw caps												
	Molded plastic, with inspection hole, black, not for SILIZED fuse links											
	NDz	500/500	25	E16			5SH1112		1	20 units	1BM	
	DII		25	E27			5SH1221		1	5 units	1BM	
	DIII		63	E33			5SH1231		1	5 units	1BM	
	Ceramic											
	DII	500/500	25	E27			5SH112		1	50 units	1BM	
	DIII		63	E33			5SH113		1	30 units	1BM	
	Ceramic, with inspection hole, sealable											
	DII	500/500	25	E27			5SH122		1	50 units	1BM	
	DIII		63	E33			5SH123		1	30 units	1BM	
	Ceramic, extended version											
	DIII	690/600	63	E33			5SH1170		1	5 units	1BM	

¹⁾ Terminal version KK: Screw head contact at incoming and outgoing feeder.

Fuse Systems

DIAZED fuse systems

	Size	Thread	For fuse links	SD	Article No. www.siemens.com/ product?Article No.	Price per PU	PU (UNIT, SET, M)	PS	PG
DIAZED screw adapters									
Also for 5SF230 to 750 V									
	DII	E27	2	d	5SH310		1	25 units	1BM
			4		5SH311		1	25 units	1BM
			6		5SH312		1	25 units	1BM
			10		5SH313		1	25 units	1BM
			16		5SH314		1	25 units	1BM
			20		5SH315		1	25 units	1BM
25	5SH316	1	25 units	1BM					
Also for 5SF230 to 750 V									
	DIII	E33	32		5SH327		1	25 units	1BM
			35		5SH317		1	25 units	1BM
			50		5SH318		1	25 units	1BM
			63		5SH320		1	25 units	1BM
DIAZED adapter sleeves for screw caps									
For DII fuse links in DIII base									
					5SH302		1	10 units	1BM
DIAZED adapter sleeve fitters									
DII/DIII									
					5SH3703		1	10 units	1BM
DIAZED caps									
Molded plastic									
	DII	E27			5SH202		1	5 units	1BM
	DIII	E33			5SH222		1	5 units	1BM
	Size	Thread		SD	Article No. www.siemens.com/ product?Article No.	Price per PU	PU (UNIT, SET, M)	PS*/ P. unit	PG
DIAZED cover rings									
Molded plastic									
	DII	E27		d	5SH3401		1	5 units	1BM
	DIII	E33			5SH3411		1	5 units	1BM

More information



DIII fuse bases with terminal version BS

- Outgoing feeders (top), saddle terminal S
- Incoming feeders (bottom), clamp-type terminal B



DII fuse bases with terminal version BB

- Outgoing feeders (top), clamp-type terminal B
- Incoming feeders (bottom), clamp-type terminal B

Fuse Systems

Cylindrical Fuse Systems

Cylindrical fuse links and cylindrical fuse holders

Overview

Cylindrical fuses are standard in Europe. There are a range of different cylindrical fuse links and holders that comply with the standards IEC 60269-1, -2 and -3, and which are suitable for use in industrial applications. In South West Europe they are also approved for use in residential buildings.

The cylindrical fuse holders are also approved according to UL 512. The cylindrical fuse holders are tested and approved as fuse disconnectors according to the switching device standard IEC 60947-3. They are not suitable for switching loads.

Cylindrical fuse holders can be supplied with or without signal detectors. In the case of devices with signal detector, a small electronic device with LED is located behind an inspection window in the plug-in module. If the inserted fuse link is tripped, this is indicated by the LED flashing.



The switching state of the fuse holder can be signaled over a laterally retrofitted auxiliary switch, which enables the integration of the fuses in the automation process.

Benefits

- Devices with pole number 1P+N are available in a single modular width. This reduces the footprint by 50%
- The sliding catch for type ranges 8 x 32 mm and 10 x 38 mm enables the removal of individual devices from the assembly
- Space for a spare fuse in the plug-in module enables the fast replacement of fuses. This saves time and money and increases system availability
- A flashing LED signals that a fuse link has been tripped. This enables fast detection during runtime

Technical specifications





		Cylindrical fuse links						
		3NW63..	3NW60..	3NW61..	3NW62..	3NW80..	3NW81..	3NW82..
Size	mm x mm	8 x 32	10 x 38	14 x 51	22 x 58	10 x 38	14 x 51	22 x 58
Standards		IEC 60269-1, -2; NF C 60-200; NF C 63-210, -211; NBN C 63269-2, CEI 32-4, -12						
Operational class		gG					aM	
Rated voltages U_n	V AC	400, 500, 690						
Rated current I_n	A	2 ... 20	0.5 ... 32	4 ... 50	8 ... 100	0.5 ... 32	2 ... 50	10 ... 100
Rated breaking capacity								
• 690 V versions	kA AC	--	--	100	--	--	100	--
• 500 V versions	kA AC	--	120	100	--	120	100	--
• 400 V versions	kA AC	20	120	20	--	120	20	--
Mounting position		Any, preferably vertical						

		Cylindrical fuse holders			
		3NW73..	3NW70..	3NW71..	3NW72..
Size	mm x mm	8 x 32	10 x 38	14 x 51	22 x 58
Standards		IEC 60269-1, -2, -3; NF C 60-200, NF C 63-210, -211; NBN C 63269-2-1; CEI 32-4, -12; UL 4248-1			
Approvals	Acc. to UL Acc. to CSA	--			--
Rated voltage U_n	Acc. to UL/CSA V AC V AC	400 400	690 600		
Rated current I_n	A AC	20	32	50	100
Rated breaking capacity	kA	20	100		
Breaking capacity		AC-20B (switching without load), DC-20B			
No-voltage changing of fuse links		Yes			
Sealable when installed		Yes			
Mounting position		Any, preferably vertical			
Degree of protection	Acc. to IEC 60529	IP20, with connected conductors ¹⁾			
Terminals with touch protection according to BGV A3 at incoming and outgoing feeder		Yes			
Ambient temperature	°C	-5 ... +40 °C, humidity 90% at +20 °C			
Conductor cross-sections					
• Rigid	mm ²	0.5 ... 10		2.5 ... 10	4 ... 10
• Stranded	mm ²	0.5 ... 10		2.5 ... 25	4 ... 50
• Finely stranded, with end sleeve	mm ²	0.5 ... 10 ²⁾		2.5 ... 16	4 ... 35
• AWG (American Wire Gauge)	AWG	--	10 ... 20	6 ... 10	--
Tightening torque	Nm	1.2		2.0	2.5

¹⁾ Degree of protection IP20 is tested according to regulations using a straight test finger (from the front), with the device mounted and equipped with a cover, housing or some other enclosure.

²⁾ Max. cross-section 10 mm² with K28 crimper from Klauke.

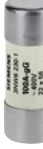
Selection and ordering data



	Size	I_n	U_n	SD	Article No. www.siemens.com/ product?Article No.	Price per PU	PU (UNIT, SET, M)	PS	PG					
	mm × mm	A	V AC	d										
	Cylindrical fuse links, operational class gG 8 × 32	2	400		3NW6302-1		1	10 units	1BM					
		4			3NW6304-1		1	10 units	1BM					
		6			3NW6301-1		1	10 units	1BM					
		10			3NW6303-1		1	10 units	1BM					
		16			3NW6305-1		1	10 units	1BM					
		20			3NW6307-1		1	10 units	1BM					
		10 × 38	0.5	500		3NW6000-1		1	10 units	1BM				
			1			3NW6011-1		1	10 units	1BM				
			2			3NW6002-1		1	10 units	1BM				
			4			3NW6004-1		1	10 units	1BM				
			6			3NW6001-1		1	10 units	1BM				
			8			3NW6008-1		1	10 units	1BM				
			10			3NW6003-1		1	10 units	1BM				
			12			3NW6006-1		1	10 units	1BM				
			16			3NW6005-1		1	20 units	1BM				
20			3NW6007-1			1		20 units	1BM					
	14 × 51	4	690		3NW6104-1		1	10 units	1BM					
		6			3NW6101-1		1	10 units	1BM					
		8			3NW6108-1		1	10 units	1BM					
		10			3NW6103-1		1	10 units	1BM					
		12			3NW6106-1		1	10 units	1BM					
		16			3NW6105-1		1	10 units	1BM					
	22 × 58	20	690		3NW6205-1		1	10 units	1BM					
		25			3NW6207-1		1	10 units	1BM					
		32			3NW6210-1		1	10 units	1BM					
		40			3NW6212-1		1	10 units	1BM					
		50			3NW6217-1		1	10 units	1BM					
		63			3NW6220-1		1	10 units	1BM					
		80			3NW6222-1		1	10 units	1BM					
		100			3NW6224-1		1	10 units	1BM					
	Cylindrical fuse links, operational class aM 10 × 38	0.5	500		3NW8000-1		1	10 units	1BM					
		1			3NW8011-1		1	10 units	1BM					
		2			3NW8002-1		1	10 units	1BM					
		4			3NW8004-1		1	10 units	1BM					
		6			3NW8001-1		1	10 units	1BM					
		8			3NW8008-1		1	10 units	1BM					
		10			3NW8003-1		1	10 units	1BM					
		12			3NW8006-1		1	10 units	1BM					
		16			3NW8005-1		1	20 units	1BM					
		20			3NW8007-1		1	20 units	1BM					
		14 × 51	2	690		3NW8102-1		1	10 units	1BM				
			4			3NW8104-1		1	10 units	1BM				
			6			3NW8101-1		1	10 units	1BM				
			8			3NW8108-1		1	10 units	1BM				
			10			3NW8103-1		1	10 units	1BM				
		12	500		3NW8106-1		1	10 units	1BM					
		16			3NW8105-1		1	10 units	1BM					
		20			3NW8107-1		1	10 units	1BM					
		25			3NW8110-1		1	10 units	1BM					
		32			3NW8112-1		1	10 units	1BM					
		40			3NW8117-1		1	10 units	1BM					
		50			3NW8120-1		1	10 units	1BM					
							40	400		3NW8117-1		1	10 units	1BM
							50			3NW8120-1		1	10 units	1BM

Fuse Systems

Cylindrical Fuse Systems



Cylindrical fuse links and cylindrical fuse holders

	Size	I_n	U_n	SD	Article No. www.siemens.com/ product?Article No.	Price per PU	PU (UNIT, SET, M)	PS	PG	
	mm × mm	A	V AC	d						
	22 × 58	16	690		3NW8205-1		1	10 units	1BM	
		20			3NW8207-1		1	10 units	1BM	
		25			3NW8210-1		1	10 units	1BM	
		32			3NW8212-1		1	10 units	1BM	
		40			3NW8217-1		1	10 units	1BM	
		50			3NW8220-1		1	10 units	1BM	
		63			500		3NW8222-1	1	10 units	1BM
		80					3NW8224-1	1	10 units	1BM
		100					3NW8230-1	1	10 units	1BM

	Number of poles	I_n	For fuse links of size	Mounting width	SD	Article No. www.siemens.com/ product?Article No.	Price per PU	PU (UNIT, SET, M)	PS	PG	
		A	mm × mm	MW	d						
	Cylindrical fuse holders with signal detector¹⁾										
	1P	20	8 × 32	1		3NW7314		1	1 unit	1BM	
		32	10 × 38	1		3NW7014		1	1 unit	1BM	
		50	14 × 51	1.5		3NW7112		1	1 unit	1BM	
		100	22 × 58	2		3NW7212		1	1 unit	1BM	
	1P+N	20	8 × 32	1		3NW7354		1	1 unit	1BM	
		32	10 × 38	1		3NW7054		1	1 unit	1BM	
		50	14 × 51	3		3NW7152		1	1 unit	1BM	
		100	22 × 58	4		3NW7252		1	1 unit	1BM	
	2P	20	8 × 32	2		3NW7324		1	1 unit	1BM	
		32	10 × 38	2		3NW7024		1	1 unit	1BM	
		50	14 × 51	3		3NW7122		1	1 unit	1BM	
		100	22 × 58	4		3NW7222		1	1 unit	1BM	
	3P	20	8 × 32	3		3NW7334		1	1 unit	1BM	
		32	10 × 38	3		3NW7034		1	1 unit	1BM	
50		14 × 51	4.5	3NW7132		1		1 unit	1BM		
100		22 × 58	6	3NW7232		1		1 unit	1BM		
3P+N	20	8 × 32	3		3NW7364		1	1 unit	1BM		
	32	10 × 38	3		3NW7064		1	1 unit	1BM		
	50	14 × 51	6		3NW7162		1	1 unit	1BM		
	100	22 × 58	8		3NW7262		1	1 unit	1BM		
	Cylindrical fuse holders without signal detector										
	1P	20	8 × 32	1		3NW7313		1	1 unit	1BM	
		32	10 × 38	1		3NW7013		1	1 unit	1BM	
		50	14 × 51	1.5		3NW7111		1	1 unit	1BM	
		100	22 × 58	2		3NW7211		1	1 unit	1BM	
	1P+N	20	8 × 32	1		3NW7353		1	1 unit	1BM	
		32	10 × 38	1		3NW7053		1	1 unit	1BM	
		50	14 × 51	3		3NW7151		1	1 unit	1BM	
		100	22 × 58	4		3NW7251		1	1 unit	1BM	
	2P	20	8 × 32	2		3NW7323		1	1 unit	1BM	
		32	10 × 38	2		3NW7023		1	1 unit	1BM	
		50	14 × 51	3		3NW7121		1	1 unit	1BM	
		100	22 × 58	4		3NW7221		1	1 unit	1BM	

¹⁾ Min. voltage of the signal detector: 48 V AC/DC

Cylindrical fuse links and cylindrical fuse holders

Number of poles	I_n	For fuse links of size	Mounting width	SD	Article No. www.siemens.com/product?Article No.	Price per PU	PU (UNIT, SET, M)	PS	PG	
	A	mm x mm	MW	d						
Cylindrical fuse holders without signal detector										
	3P									
	20	8 x 32	3		3NW7333		1	1 unit	1BM	
	32	10 x 38	3		3NW7033		1	1 unit	1BM	
	50	14 x 51	4.5		3NW7131		1	1 unit	1BM	
	100	22 x 58	6		3NW7231		1	1 unit	1BM	
	3P+N									
	20	8 x 32	3		3NW7363		1	1 unit	1BM	
	32	10 x 38	3		3NW7063		1	1 unit	1BM	
50	14 x 51	6		3NW7161		1	1 unit	1BM		
100	22 x 58	8		3NW7261		1	1 unit	1BM		
Auxiliary switches										
	For indicating disconnection of the fuse link, solely for application of striker fuse links. For retrofitting using the factory-fitted brackets. Contact: 250 V AC, 5 A Minimum contact load: 12 V, 25 mA									
	For fuse bases	14 x 51	0.5		3NW7901		1	1 unit	1BM	
	For fuse bases	22 x 58			3NW7902		1	1 unit	1BM	
For indicating the switching state of the fuse holder. For retrofitting using the factory-fitted brackets. Contact: 230 V AC, 6 A/110 V DC, 1 A Minimum contact load: 12 V, 25 mA Terminals 1.5 mm ² - 0.5 Nm										
For fuse holders	10 x 38 and 8 x 32	0.5			3NW7903		1	1 unit	1BM	

More information

Mounting

Fuse holders, sizes 8 x 32 mm and 10 x 38 mm, have a sliding catch that enables the removal of individual devices from the assembly.

The infeed can be from the top or the bottom. Because the cylindrical fuse holders are fitted with the same anti-slip terminals at the top and the bottom, the devices can also be bus-mounted at the top or the bottom.

Auxiliary switches

Auxiliary switches are available for the cylindrical fuse holders. These are simply clipped onto the base using the factory-fitted brackets.

Sizes 8 x 32 mm and 10 x 38 mm:

The auxiliary switches support the remote display of the switching state ON or OFF of the fuse holder.

Sizes 14 x 51 mm and 22 x 58 mm:

The auxiliary switches support the remote display of fuse failure. However, fuse links with strikers are required for this function. When the fuse is tripped, a small striking pin – the striker – shoots out of the front of the fuse. Over an armature link in the auxiliary switch, the kinetic energy of this striker is used to switch a mini switch, which then initializes this signal over a floating contact.

Fuse Systems

Cylindrical Fuse Systems

Fuse holders in size 10 x 38 mm and Class CC

Overview

A key feature of our three-pole fuse holders is their ultra compact design. With a width of only 45 mm, they are ideal for use with fused motor starter combinations. Because the contactor and the fuse holder have the same 45 mm width, they are easy to mount on top of one another. The strong current-limiting fuses ensure a type 2 protection level (coordination according to IEC 60947-4, no damage protection) for the contactors.

The UL version has an SCCR value of 200 kA. The accessories are generally UL-certified.

Customers can mount an auxiliary switch which signals the switching state or prevents the fuse holder from switching off under load by interrupting the contactor control, thus increasing safety for the operator and process. Busbars and a matching three-phase feeder terminal complete the product range.

Benefits

- Compact design, especially for motor starter combinations
- For IEC fuses of size 10 x 38 mm up to 32 A and Class CC UL fuses up to 30 A
- Meets the requirements of UL 508 with regard to clearances
- UL-approved microswitches, busbars and adapters for 60 mm busbar systems
- Optical signal detector for fast fault locating

5





Compact fuse holder Class CC with signal detector and mounted auxiliary switch





Installation configuration of a cylindrical fuse holder and a SIRIUS contactor on busbar device adapter for the 60 mm busbar system

Technical specifications

		Cylindrical fuse holders 3NW70...-1	Fuse holders 3NW75...-1HG
Size	mm x mm	10 x 38	Class CC
Standards		IEC 60269; UL4248-1; CSA	UL4248-1; CSA
Approvals		 UL File No. E171267	 UL File No. E171267
Rated voltage U_n	V AC	690	600
Rated current I_n	A AC	32	30
Rated short-circuit strength	kA	120 (at 500 V) 80 (at 690 V)	200
Breaking capacity			
• Utilization category		AC-20B (switching without load)	--
Rated impulse withstand voltage	kV	6	
Overvoltage category		III	
Pollution degree		2	
Max. power dissipation of the fuse link	W	3	
No-voltage changing of fuse links	°C	-5 ... +40 °C, humidity 90% at +20 °C	
Sealable when installed		Yes	
Lockable with padlock		Yes	
Mounting position		Any, preferably vertical	
Current direction		Any	
Degree of protection	Acc. to IEC 60529	IP20, with connected conductors ¹⁾	
Terminals with touch protection according to BGV A3 at incoming and outgoing feeder		Yes	
Ambient temperature	°C	-5 ... +40 °C, humidity 90% at +20 °C	
Conductor cross-sections			
• Finely stranded, with end sleeve	mm ²	1 ... 4	
• AWG cables (American Wire Gauge)	AWG	18 ... 10	
Tightening torque			
• Terminal screws	Nm lb-in	1.5 13 PZ2	

¹⁾ Degree of protection IP20 is tested according to regulations using a straight test finger (from the front), with the device mounted and equipped with a cover, housing or some other enclosure.

		Auxiliary switches 3NW7903-1							
Standards		IEC 60947							
Approvals		  UL 508, UL File No. E334003							
Utilization category		AC-12	DC-13			AC-15			Acc. to UL
Rated voltage U_n	V AC V DC	250 --	-- 24	-- 120	-- 240	24 --	120 --	240 --	240 --
Rated current I_n	A	5	2	0.5	0.25	4	3	1.5	5

		Busbars 5ST260.	
For cylindrical fuse holders		3NW70...-1	3NW75...-1HG
Pin spacing	mm	15	
Standards		EN 60974-1 (VDE 0660-100), IEC 60947-1:2004, UL 508, CSA 22.2	
Approvals		 UL 4248-1, UL File No. E337131	
Busbar material		E-Cu 58 F25	
Partition material		PA66-V0	
Lamp wire resistance/1.5 mm²	°C	960	
Insulation coordination		Overvoltage category III, degree of pollution 2	
Rated operating voltage U_n			
• Acc. to UL	V AC	--	600
• Acc. to IEC	V AC	690	--
Maximum busbar current I_n			
• Acc. to UL	A	--	65
• Acc. to IEC	A	80	--

Fuse Systems











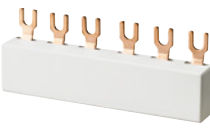

Cylindrical Fuse Systems

Fuse holders in size 10 x 38 mm and Class CC

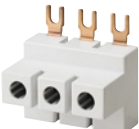
		Terminals 5ST2600	
For cylindrical fuse holders		3NW70...-1	3NW75...-1HG
Pin spacing	mm	15	
Standards		IEC 60999:2000, UL 508	
Approvals		Ⓢ, UL 4248-1, UL File No. E337131	
Enclosure/cover material		PA66-V0	
Lamp wire resistance/1 mm²	°C	960	
Temperature resistance PA66-V0, HDT B ISO 179, UL 94-V0/1.5	°C	200	
Insulation coordination		Overvoltage category III, degree of pollution 2	
Maximum operating voltage U_{max}			
• Acc. to UL	V AC	--	600
• Acc. to IEC	V AC	690	--
Maximum electrical load I_{max}			
• Acc. to UL	A	--	65
• Acc. to IEC	A	80	--
Rated current I_n	A	63	
Conductor cross-sections			
• Solid/stranded	mm ²	2.5 ... 35	
• Finely stranded, with end sleeve	mm ²	2.5 ... 25	
Tightening torque of clamping screw	Nm	2.5 ... 3.5	

5

Selection and ordering data

	Number of poles	I_n	For fuse links of size	Mounting width	SD	Article No. www.siemens.com/ product?Article No.	Price per PU	PU (UNIT, SET, M)	PS	PG
	A		mm x mm	MW	d					
3NW7 cylindrical fuse holders										
	Cylindrical fuse holders 									
	3P	32	10 x 38	2.5		3NW7033-1 3NW7034-1		1	1 unit	1BM
								1	1 unit	1BM
	Fuse holders Class CC 									
	3P	30	Class CC	2.5		3NW7533-1HG 3NW7534-1HG		1	1 unit	1DN
								1	1 unit	1DN
Accessories										
Auxiliary switches 										
	AC-12, 5 A, max. 250 V, 1 NO, 1 NC			2.5		3NW7903-1		1	1 unit	1BM
5ST2 60. busbar system										
	Busbars 									
	2 x 3P	63	15	45		5ST2601 5ST2602 5ST2603 5ST2604		1	10 units	1AD
	3 x 3P			90				1	10 units	1AD
	4 x 3P			135				1	10 units	1AD
	5 x 3P			180				1	10 units	1AD
Accessories										
	Terminals 									
	For conductor cross-sections 2.5 mm ² ... 35 mm ²						5ST2600		1	10 units
Device adapters										
	Busbar device adapters¹⁾ with connecting cables (above) 									
						8US1251-5DS10 8US1251-5DT10		1	1 unit	1CU
								1	1 unit	1CU
Accessories										
	Mounting rails for busbar device adapter 									
	For assembly of additional devices			45			8US1998-7CB45		1	10 units

¹⁾ For further device adapters and accessories, see chapter "Busbar Systems".

Fuse Systems

Fuse Systems acc. to UL

Class CC fuse systems

Overview

Class CC fuses are used for "branch circuit protection".

The characteristic of the fuse links is designed and tested to comply with the US National Electrical Code NEC 210.20(A). This means that when subject to continuous operation, only 80% of the rated current is permissible as operational current.

An operational current of 100% of the rated current (30 A) is only permissible short-time.

The devices are prepared for the inscription labels of the ALPHA FIX terminal blocks 8WH8120-7AA15 and 8WH8120-7XA05.

There are three different series:

- Characteristic: Slow 3NW1...-0HG
For the protection of control transformers, reactors, inductances. Significantly slower than the minimum requirements specified by UL for Class CC fuses of 12 s at $2 \times I_n$

- Characteristic: Quick 3NW2...-0HG
For a wide range of applications, for the protection of lighting installations, heating, control systems.
- Characteristic: Slow, current-limiting, 3NW3...-0HG
Slow for overloads and quick for short circuits. High current limitation for the protection of motor circuits.

Note:

For Class CC compact fuse holders for motor starter combinations, [see page 5/25](#).

Benefits

- For switchboard assemblies and machine manufacturers who export their systems to the USA or Canada
- Easier export due to UL and CSA approvals for typical applications
- Modern design with touch protection to BGV A3 ensures safe installation.



Technical specifications

		Class CC fuse holders 3NW75.3-0HG	
Standards Approvals		UL 4248-1; CSA C22.2 UL 4248-1; UL File No. E171267; CSA C22.2	
Rated voltage U_n	V	AC: 600 / DC: 300	
Rated current I_n	A	30	
Rated conditional short-circuit current	kA	200	
Breaking capacity		AC-20B (switching without load)	
• Utilization category			
Max. power dissipation of the fuse link			
• With cable, 6 mm ²	W	3	
• With cable, 10 mm ²	W	4.3	
Rated impulse withstand voltage	kV	6	
Overvoltage category		II	
Pollution degree		2	
No-voltage changing of fuse links		Yes	
Sealable when installed		Yes	
Mounting position		Any	
Current direction		Any	
Degree of protection acc. to IEC 60529		IP20 ¹⁾	
Terminals with touch protection according to BGV A3 at incoming and outgoing feeder		Yes	
Ambient temperature	°C	45 -> from -5 to +40	
Conductor cross-sections			
• Solid and stranded	mm ²	1.5 ... 16	
• AWG conductor cross-section, solid and stranded	AWG	15 ... 5	
Tightening torque	Nm	2.5 (22 lb.in)	

¹⁾ Degree of protection IP20 is tested according to regulations using a straight test finger (from the front), with the device mounted and equipped with a cover, housing or some other enclosure.

		Class CC fuse links		
		3NW1...-0HG	3NW2...-0HG	3NW3...-0HG
Standards Approvals		UL 248-4; CSA C22.2 UL 248-4; UL File No. E258218; CSA C22.2		
Characteristic		Slow	Quick	Slow, current limiting
Rated voltage	V AC	600	600	600
	V DC	--	--	150 (3 ... 15 A) 300 (< 3 A, > 15 A)
Rated breaking capacity	kA AC	200		

Selection and ordering data

Number of poles	U_n	I_n	Mounting width	SD	Article No. www.siemens.com/ product?Article No.	Price per PU	PU (UNIT, SET, M)	PS	PG
	V	A							
Class CC fuse holders									
	1P	600	30	1	3NW7513-0HG 3NW7523-0HG 3NW7533-0HG		1	12 units	1DN
	2P	600	30	2			1	6 units	1DN
	3P	600	30	3			1	4 units	1DN
Characteristic: slow									
I_{n1}				SD	Article No. www.siemens.com/ product?Article No.	Price per PU	PU (UNIT, SET, M)	PS	PG
A				d					
Class CC fuse links									
	0.6 (6/10) ¹⁾				3NW1006-0HG 3NW1008-0HG 3NW1010-0HG 3NW1015-0HG 3NW1020-0HG 3NW1025-0HG 3NW1030-0HG 3NW1040-0HG 3NW1050-0HG 3NW1060-0HG 3NW1075-0HG 3NW1080-0HG 3NW1100-0HG -- 3NW1150-0HG 3NW1200-0HG 3NW1250-0HG 3NW1300-0HG		1	10 units	1DN
	0.8 (8/10) ¹⁾						1	10 units	1DN
	1						1	10 units	1DN
	1.5 (1 1/2) ¹⁾						1	10 units	1DN
	2						1	10 units	1DN
	2.5						1	10 units	1DN
	3						1	10 units	1DN
	4						1	10 units	1DN
	5						1	10 units	1DN
	6						1	10 units	1DN
	7.5						1	10 units	1DN
	8						1	10 units	1DN
	10						1	10 units	1DN
	12						1	10 units	1DN
	15						1	10 units	1DN
	20						1	10 units	1DN
25				1	10 units	1DN			
30				1	10 units	1DN			
Characteristic: quick									
I_{n1}				SD	Article No. www.siemens.com/ product?Article No.	Price per PU	PU (UNIT, SET, M)	PS	PG
A				d					
Class CC fuse links									
	0.6 (6/10) ¹⁾				-- -- 3NW2010-0HG -- 3NW2020-0HG -- 3NW2030-0HG 3NW2040-0HG 3NW2050-0HG 3NW2060-0HG -- 3NW2080-0HG 3NW2100-0HG 3NW2120-0HG 3NW2150-0HG 3NW2200-0HG 3NW2250-0HG 3NW2300-0HG		1	10 units	1DN
	0.8 (8/10) ¹⁾						1	10 units	1DN
	1						1	10 units	1DN
	1.5 (1 1/2) ¹⁾						1	10 units	1DN
	2						1	10 units	1DN
	2.5						1	10 units	1DN
	3						1	10 units	1DN
	4						1	10 units	1DN
	5						1	10 units	1DN
	6						1	10 units	1DN
	7.5						1	10 units	1DN
	8						1	10 units	1DN
	10						1	10 units	1DN
	12						1	10 units	1DN
	15						1	10 units	1DN
	20						1	10 units	1DN
25				1	10 units	1DN			
30				1	10 units	1DN			

¹⁾ Values in brackets, American English wording.

Fuse Systems

Fuse Systems acc. to UL

Class CC fuse systems

I_n	SD	Characteristic: slow, current-limiting Article No. www.siemens.com/ product?Article No.	Price per PU	PU (UNIT, SET, M)	PS	PG
Class CC fuse links						
1		3NW3010-0HG		1	10 units	1DN
2		3NW3020-0HG		1	10 units	1DN
3		3NW3030-0HG		1	10 units	1DN
4		3NW3040-0HG		1	10 units	1DN
5		3NW3050-0HG		1	10 units	1DN
6		3NW3060-0HG		1	10 units	1DN
8		3NW3080-0HG		1	10 units	1DN
10		3NW3100-0HG		1	10 units	1DN
12		3NW3120-0HG		1	10 units	1DN
15		3NW3150-0HG		1	10 units	1DN
20		3NW3200-0HG		1	10 units	1DN
25		3NW3250-0HG		1	10 units	1DN
30		3NW3300-0HG		1	10 units	1DN



5

Overview

The 30 A and 60 A fuse holders are modular installation devices for mounting on a DIN rail (standard mounting rail). These devices can also be mounted on the 60 mm busbar system using busbar adapters of appropriate width. The 100 A, 200 A and 400 A fuse holders are available as versions either for screwing onto a mounting plate or for directly mounting on the 60 mm busbar system.

Note:

For more information, see chapter "Busbar Systems".

Benefits

- For switchboard assemblies and machine manufacturers who export their switchboards to the USA or Canada
- Easier export due to UL and CSA approvals
- Modern fuse holder design with touch protection to BGV A3 ensures safe installation
- Fuse holders up to 200 A enable fuses to be changed in de-energized condition
- Efficient power distribution thanks to mounting the devices on 60 mm busbar system.

Technical specifications

		Class J fuse holders 3NW75.3-0HG				
Standards		UL 4248-1 Ed.1, UL 4248-8 Ed.1, UL File No. E171267 CSA File No. 233322, Class No. 6225-01				
Approvals		UL, CE		c ULus		UL, CE c ULus (busbar device)
Rated current I_n	A	30	60	100	200	400
Rated voltage U_n acc. to UL	V AC	600				
	V DC	600				
Conditional rated current (SCCR withstand rating)		200				200 65 (busbar device)
Switching capacity		AC-20B (switching without load)				
Utilization category		DC-20B (switching without load)				
Rated impulse withstand voltage	kV	No information as the devices are only tested and certified to UL/CSA and not to IEC				
Overvoltage category						
Pollution degree						
No-voltage changing of fuse links		Yes				No
Sealable when installed		Yes				
Mounting position		Any, preferably vertical				
Current direction		For surface mounting devices: any, for busbar devices: output via terminals				
Degree of protection acc. to IEC 60529		IP20				
Ambient temperature		-5 ... +40 °C				
Plastics		Self-extinguishing acc. to UL 94, tracking resistance min. CTI 200, halogen-free				
Temperature resistance		up to 125 °C		up to 120 °C		up to 125 °C
Conductor cross-sections						
• Acc. to IEC/EN	mm ²	0.75 ... 50	2.5 ... 50	1.5 ... 70	35 ... 150	16 ... 300
• Acc. to UL/CSA	AWG	AWG 18 ... AWG 1	AWG 14 ... AWG 1	AWG 12 ... AWG 2/0	AWG 2 ... MCM 300	AWG 4 ... MCM 600
Tightening torque		up to 1 mm ² / $>$ 1 mm ² :				
• Acc. to IEC/EN	Nm	2.0 ... 2.5/3.5 ... 4.0	4.0	5	6	38
• Acc. to UL/CSA	lb.in.	18 ... 22/31 ... 35	35	45	53	336
Busbar devices						
Conductor cross-sections						
• Acc. to IEC/EN	mm ²	--	--	1.5 ... 70	35 ... 150	16 ... 300
• Acc. to UL/CSA	AWG	--	--	AWG 12 ... AWG 2/0	AWG 2 ... MCM 300	AWG 4 ... MCM 600
Tightening torque						
• Acc. to IEC/EN	Nm	--	--	5	6	32
• Acc. to UL/CSA	lb.in.	--	--	45	53	285

Fuse Systems

Fuse Systems acc. to UL

Class J fuse systems

Selection and ordering data

Number of poles	U_n	I_n	Mounting width	SD	Article No. www.siemens.com/ product?Article No.	Price per PU	PU (UNIT, SET, M)	PS	PG
	V	A	mm	d					
Class J fuse holders									
• Modular devices for mounting on DIN mounting rail									
1P	600	30	36 (2 MW)		3NW7511-3HG		1 6 units		1DN
2P	600	30	72 (4 MW)		3NW7521-3HG		1 3 units		1DN
3P	600	30	108 (6 MW)		3NW7531-3HG		1 2 units		1DN
1P	600	60	40		3NW7511-5HG		1 6 units		1DN
2P	600	60	80		3NW7521-5HG		1 3 units		1DN
3P	600	60	120		3NW7531-5HG		1 2 units		1DN
• For screwing onto mounting plate ¹⁾									
3P	600	100	106		3NW7531-6HG		1 1 unit		1DN
3P	600	200	184		3NW7531-7HG		1 1 unit		1DN
3P	600	400	256		3NW7531-8HG		1 1 unit		1DN

¹⁾ For versions for direct mounting on 60 mm busbar system, see chapter "Busbar Systems"
--> 8US 60 mm busbar systems up to 1600 A --> Built-in components



5

Overview

Busbars with pin-type connections can be used for NEOZED fuse devices and fuse bases. Busbars in 10 mm² and 16 mm² versions are available.

Busbars with fork plugs are used for the most frequently used NEOZED fuse bases made of ceramic.

Benefits

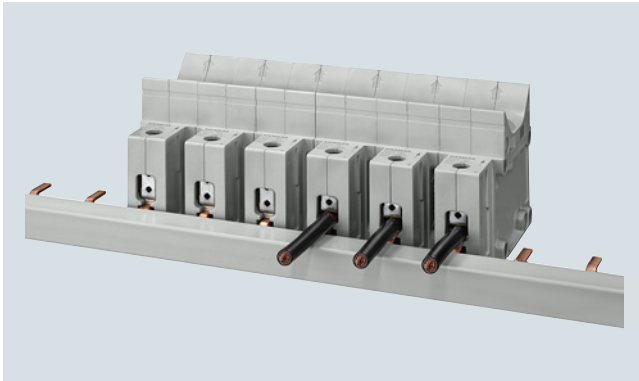

- Clear and visible conductor connection that can be easily checked when using the NEOZED D02 comfort base and which facilitates cable entry



- Bus-mounting of NEOZED fuse bases made of ceramic on three-phase busbar with fork plug, which can be cut to length

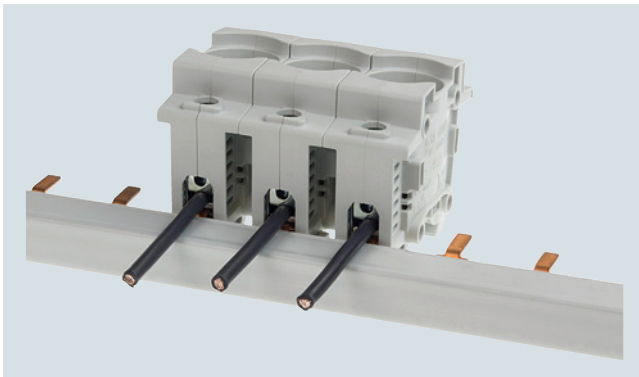

- Bus-mounting of the new NEOZED fuse base made of molded plastic on three-phase busbar with pin-type connection which can be cut to length, busbar at top for easily visible conductor connection

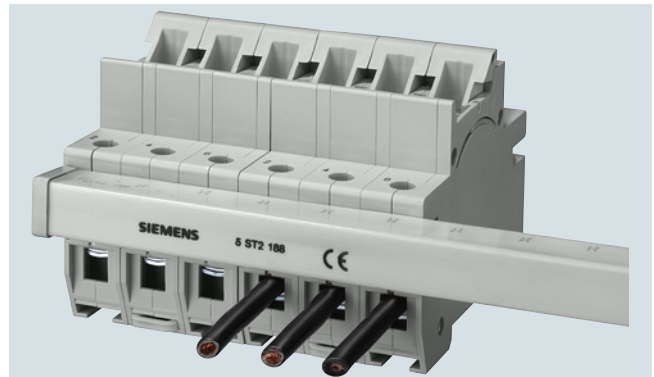

- Bus-mounting of MINIZED D01 fuse switch disconnectors on 3-phase busbar with fork plug, can be cut to length

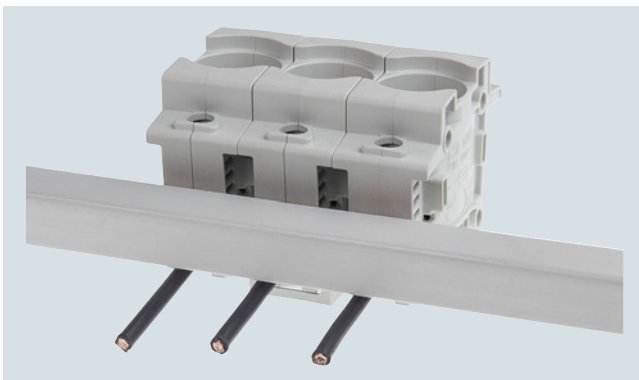

- Bus-mounting of the new NEOZED fuse base made of molded plastic on three-phase busbar with pin-type connection which can be cut to length, busbar at bottom for maximum conductor connection

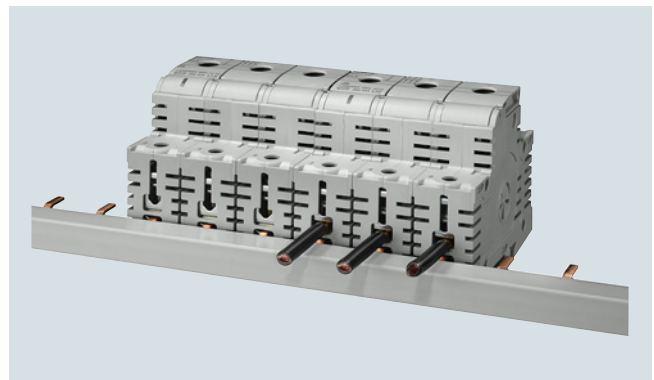

- Clear and visible conductor connection that can be easily checked when using MINIZED D02 switch disconnectors. This facilitates cable entry and saves time

Fuse Systems

Busbar systems

5

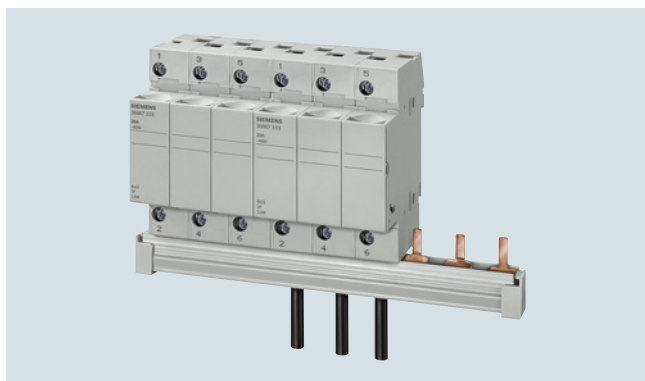

- Bus-mounting of cylindrical fuse holders 8 × 32 mm and 10 × 38 mm with three-phase pin busbar that can be cut to length



- Bus mounting with infeed through a connection terminal directly on the fuse holder up to a conductor cross-section of 25 mm²

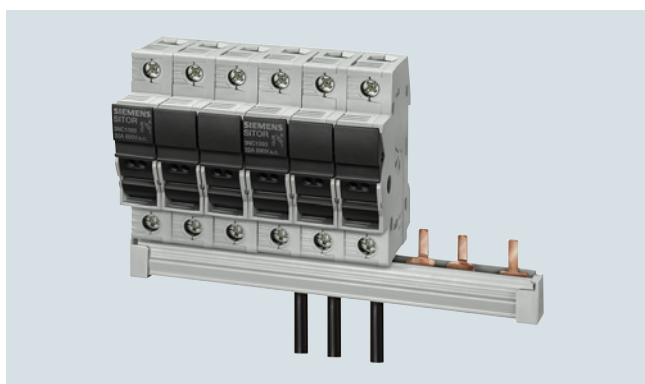

- Bus-mounting of SITOR cylindrical fuse holders 10 × 38 mm with the same terminal connection as Class CC fuse holders with three-phase pin busbar that can be cut to length

Technical specifications

		5ST, 5SH
Standards		EN 60439-1 (VDE 0660-500): 2005-01
Busbar material		SF-Cu F 24
Partition material		Plastic, Cycloy 3600, Heat-resistant over 90 °C, Flame-retardant, Self-extinguishing, Dioxin and halogen-free
Rated operational voltage U_c	V AC	400
Rated current I_n		
• Cross-section 10 mm ²	A	63
• Cross-section 16 mm ²	A	80
Rated impulse withstand voltage U_{imp}	kV	4
Test pulse voltage (1.2/50)	kV	6.2
Rated conditional short-circuit current I_{cc}	kA	25
Resistance to climate		
• Constant atmosphere	Acc. to DIN 50015	23/83; 40/92; 55/20
• Humid heat	Acc. to IEC 60068-2-30	28 cycles
Insulation coordination		
• Overvoltage category		III
• Pollution degree		2
Maximum busbar current I_S per phase		
• Infeed at the start of the busbar		
- Cross-section 10 mm ²	A	63
- Cross-section 16 mm ²	A	80
• Infeed at the center of the busbar		
- Cross-section 10 mm ²	A	100
- Cross-section 16 mm ²	A	130

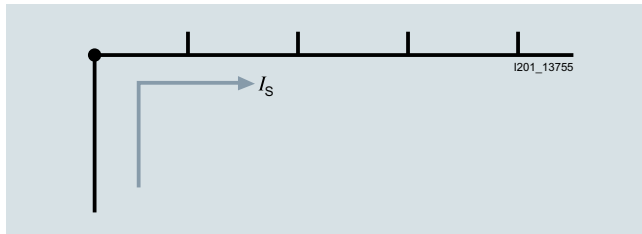
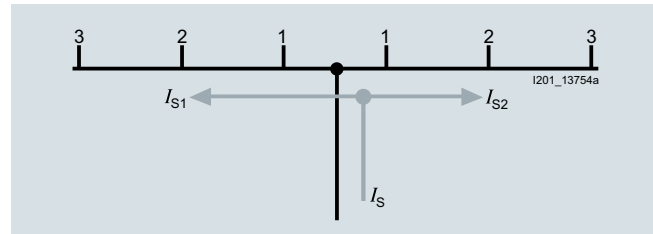

5ST37 . . -HG busbars acc. to UL 508

	5ST37..-0HG	5ST37..-2HG	5ST3770-0HG	5ST3770-1HG
Standards	UL 508, CSA C22.2 No. 14-M 95			
Approvals	UL 508 File No. E328403 CSA			
Operational voltage				
• Acc. to IEC	V AC	690		
• Acc. to UL 489	V AC	600		
Rated conditional short-circuit current	kA	10 (RMS symmetrical 600 V for three cycles)		
• Dielectric strength	kV/mm	25		
• Surge strength	kV	> 9.5		
Rated current	A	--	--	115
Maximum busbar current I_S per phase				
• Infeed at the start of the busbar	A	80	100	--
• Infeed at the center of the busbar	A	160	200	--
Insulation coordination				
• Overvoltage category	III			
• Pollution degree	2			
Busbar cross-section	mm ² Cu	18	25	--
Infeed	Any			
Conductor cross-sections	AWG	--	--	10 ... 1/0
	mm ²	--	--	6 ... 35
Terminals				
• Terminal tightening torque	Nm	--	--	5
	lb-in	--	--	35

Infeed at the start of the busbar**Infeed along the busbar or midpoint infeed**





The sum of the output currents per branch must not be greater than the busbar current $I_{S1,2}$ /phase.

Selection and ordering data



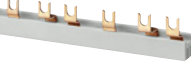

	Phases	Conductor cross-section	Load capacity up to	Pin spacing	Length	SD	Article No. www.siemens.com/product?Article No.	Price per PU	PU (UNIT, SET, M)	PS	PG
		mm ²	A	MW	mm	d					
Busbars											
	Single-phase	16	130	1.5	1016	▶	5ST3703		1	1 unit	1AD
	Three-phase	16	120	1.5	1016		5ST3714		1	1 unit	1AD
	<p>For MINIZED D02 5SG71.3 switch disconnectors For NEOZED D01/D02 fuse bases made of molded plastic 5SG1301, 5SG1701, 5SG5301, 5SG5701, 5SG1302, 5SG1702, 5SG5302, 5SG5702</p> <p>For NEOZED D01/D02 fuse bases made of ceramic terminal version S (saddle terminal) For cylindrical fuse holder 14 x 51 mm For cylindrical fuse holder SITOR 14 x 51 mm Can be cut to length, without end caps</p>										

Fuse Systems

Busbar systems

	Phases	Conductor cross-section mm ²	Load capacity up to A	Pin spacing MW	Length mm	SD d	Article No. www.siemens.com/ product?Article No.	Price per PU	PU (UNIT, SET, M)	PS	PG	
For MINIZED D01 fuse switch disconnectors												
	Can be cut to length, without end caps											
	Single-phase	16	120	1	1000		5ST2190		1	1 unit	1AD	
	Two-phase						5ST2191		1	1 unit	1AD	
	Three-phase						5ST2192		1	1 unit	1AD	
	Can be cut to length, with 2 end caps											
	Single-phase	16	120	1	220		5ST2186		1	1 unit	1AD	
Two-phase						5ST2187		1	1 unit	1AD		
Three-phase						5ST2188		1	1 unit	1AD		
For NEOZED D01/D02 fuse bases												
<ul style="list-style-type: none"> • 5SG1.30, 5SG1.31, 5SG5.30 made of molded plastic • Made of ceramic, terminal version B and K (clamp-type terminal, screw head contact) 												
	Non-insulated											
	Single-phase	36	168	1.5			5SH5322		1	1 unit	1BM	
	Can be cut to length, without end caps											
	Single-phase	24	160	1.5	1000		5SH5517		1	1 unit	1BM	
	Can be cut to length, without end caps											
	Three-phase	16	120	1.5	1000		5SH5320		1	1 unit	1BM	
	For cylindrical fuse holder 8 x 32 mm and 10 x 38 mm											
For cylindrical fuse holder SITOR 10 x 38 mm												
For class CC fuse holder ¹⁾												
	Can be cut to length, without end caps											
	Single-phase	16	120	1	1016	▶	5ST3701		1	1 unit	1AD	
	Two-phase		120	1		▶	5ST3705		1	1 unit	1AD	
	Three-phase	16	120	1	1016	▶	5ST3710		1	1 unit	1AD	
	Can be cut to length, with end caps											
	Single-phase	16		1	214	▶	5ST3700		1	1 unit	1AD	
Two-phase			1		▶	5ST3704		1	1 unit	1AD		
Three-phase			1		▶	5ST3708		1	1 unit	1AD		
End caps for busbars												
	For single-phase 5ST2190 busbars											
								5ST2196		1	10 units	1AD
	For two-phase 5ST2191 busbars and for three-phase 5ST2192 busbars											
								5ST2197		1	10 units	1AD
For single-phase 5ST37, 5SH55 busbars												
							5ST3748		1	10 units	1AD	
For two-phase and three-phase 5ST37 and 5SH5320 busbars												
							5ST3750		1	10 units	1AD	

1) For UL-approved busbars, see page 5/36.

Phases	Conductor cross-section mm ²	Load capacity up to A	Length mm	SD d	Article No. www.siemens.com/ product?Article No.	Price per PU	PU (UNIT, SET, M)	PS	PG
Touch protection for free connection of pin busbars									
	Yellow (RAL 1004) 5 x 1 pin				5ST3655		1	10 units	1AD
Terminals									
	For NEOZED fuse bases D01/D02 made of ceramic For DIAZED fuse bases DII/DIII made of ceramic Terminal version S For conductors 2 ... 25				5SH5327		1	10 units	1BM
	Terminal versions B and K For conductors 6 ... 25				5SH5328		1	10 units	1BM
	For the infeed of fork-type or pin busbars For conductors 6 ... 35				5ST2157		1	5 units	1AD
Bus-mounting terminals									
	For DIAZED EZR bus-mounting bases Non-insulated For conductors 1.5 ... 16 For conductors 10 ... 35				8JH4122 8JH4124		1	10 units	1BR
							1	10 units	1BR

Fuse Systems

Busbar systems

5ST37...-HG busbars acc. to UL 508

	Pin spacing	Length	SD	Article No. www.siemens.com/ product?Article No.	Price per PU	PU (UNIT, SET, M)	PS	PG
	MW	mm	d					
5ST37...-HG busbars acc. to UL 508, 18 mm², can be cut, without end caps								
	Single-phase							
	• For fuse holders 10 x 38 mm Class CC (3NC1091, 3NW7513-0HG) or MCBs 1P (5SY)	1	1000	5ST3701-0HG		1	1 unit	1AE
	• For fuse holders 14 x 51 mm (3NC1491, 3NW7111) or MCBs 1P (5SY, 5SP) with AS or FC	1.5	1000	5ST3703-0HG		1	1 unit	1AE
	Two-phase							
	• For fuse holders 10 x 38 mm/Class CC (3NC1092, 3NW7523-0HG) or MCBs 2P (5SY)	1	1000	5ST3705-0HG		1	1 unit	1AE
	Three-phase							
	• For fuse holders 10 x 38 mm/Class CC (3NC1093, 3NW7533-0HG) or MCBs 3P (5SY)	1	1000	5ST3710-0HG		1	1 unit	1AE
	• For fuse holders 14 x 51 mm (3NC1493, 3NW7131) or MCBs 1P (5SY, 5SP) with AS or FC	1.5	1000	5ST3714-0HG		1	1 unit	1AE
5ST37...-HG busbars acc. to UL 508, 25 mm², can be cut, without end caps								
	Single-phase							
	• For fuse holders 14 x 51 mm (3NC1491, 3NW7111) or MCBs 1P (5SP)	1.5	1000	5ST3701-2HG		1	1 unit	1AE
	Two-phase							
	• For fuse holders 14 x 51 mm (3NC1492, 3NW7121) or MCBs 2P (5SP)	1.5	1000	5ST3705-2HG		1	1 unit	1AE
	Three-phase							
	• For fuse holders 14 x 51 mm (3NC1493, 3NW7131) or MCBs 3P (5SP)	1.5	1000	5ST3710-2HG		1	1 unit	1AE
End caps for 5ST37...-HG								
	• For single-phase busbars			5ST3748-0HG		1	10 units	1AE
	• For two and three-phase busbars			5ST3750-0HG		1	10 units	1AE
Terminals according to UL 508								
	Infeed to device							
	• 35 mm ²			5ST3770-0HG		1	10 units	1AE
	Infeed to busbar							
	• 50 mm ²			5ST3770-1HG		1	10 units	1AE
Touch protection cover for bus-bars according to UL 508								
	• 5 x 1 pin			5ST3655-0HG		1	10 units	1AE

Overview

LV HRC fuse systems (NH type) are used for installation systems in non-residential, commercial and industrial buildings as well as in switchboard assemblies of power utilities. They therefore protect essential building parts and systems.

LV HRC fuse systems (NH type) are fuse systems designed for operation by experts. There are no constructional requirements for non-interchangeability of rated current and touch protection.

The components and auxiliary equipment are designed in such a way as to ensure the safe replacement of LV HRC fuse systems or isolation of systems.

LV HRC fuse links are available in the sizes 000, 00, 0, 1, 2, 3, 4 and 4a.

LV HRC fuse links are available in the following operational classes:

- gG for cable and line protection
- aM for short-circuit protection of switching devices in motor circuits
- gR or aR for protection of power semiconductors
- gS: The new gS operational class combines cable and line protection with semiconductor protection

LV HRC fuse links of size 000 can also be used in LV HRC fuse bases, LV HRC fuse switch disconnectors, LV HRC fuse strips as well as LV HRC in-line fuse switch disconnectors of size 00.

The fuse links 300 A, 355 A and 425 A comply with the standard but do not have the VDE mark.

LV HRC components

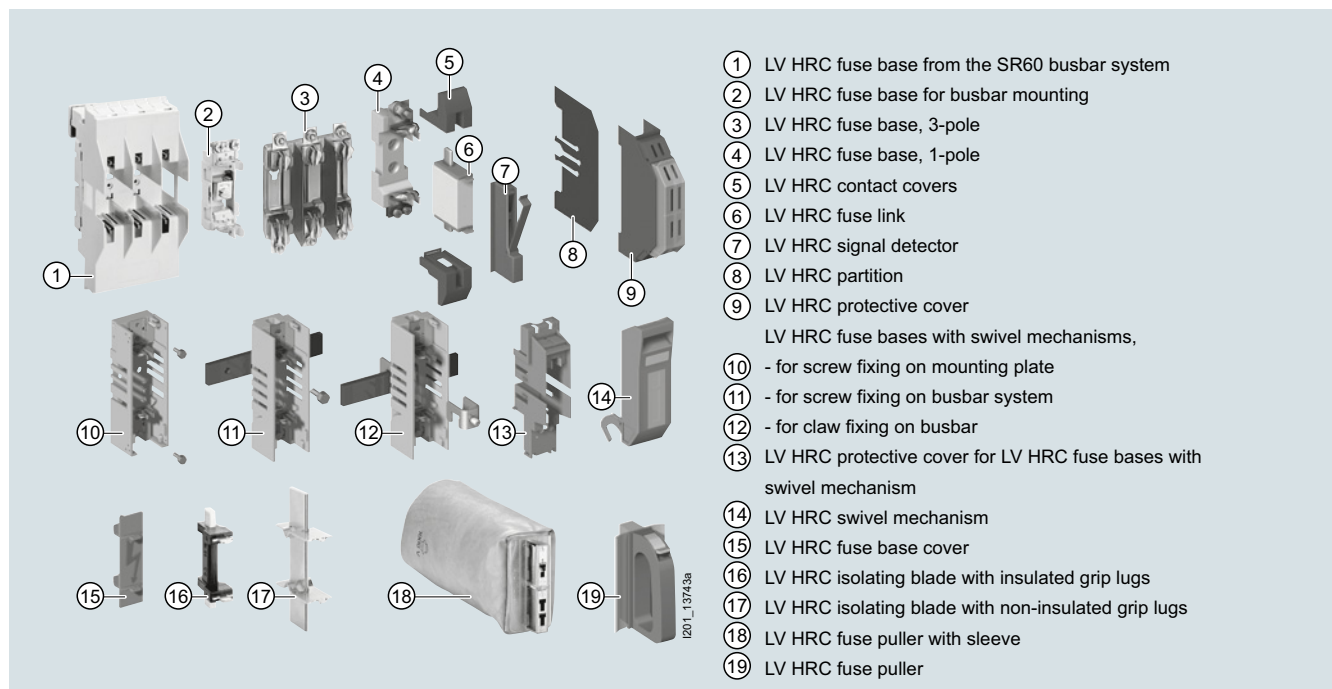



Fuse Systems

3NA, 3ND LV HRC Fuse Systems

LV HRC fuse links

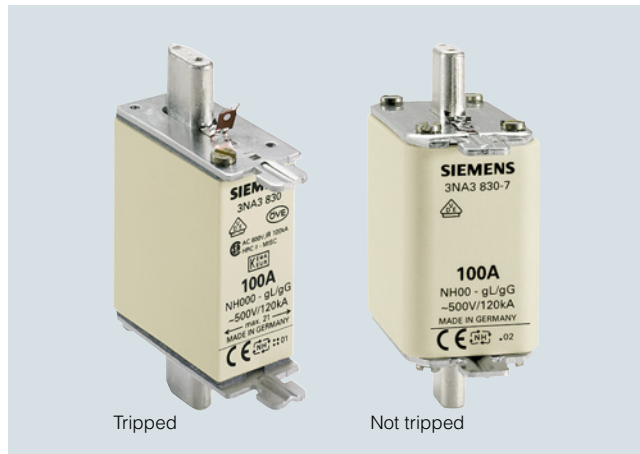
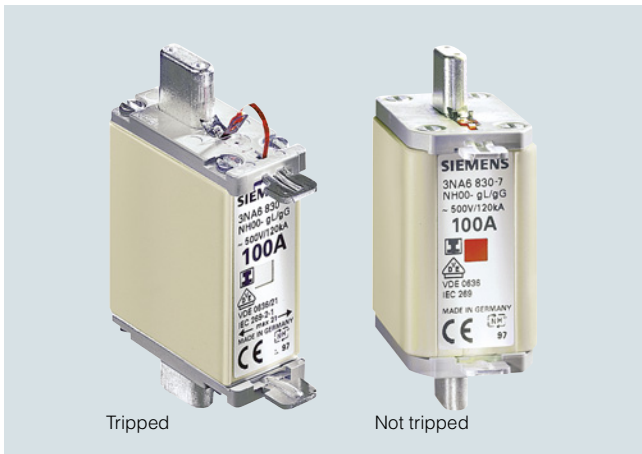
Benefits



- LV HRC fuse links with combination alarm signal the tripping of a fuse by a clear color change from red to white. This enables fast identification and replacement of the tripped fuse links. This increases system availability
- The insulated grip lugs made of metal are integrated in the top and bottom covers of the fuse link in molded plastic and provide greater safety during replacement. The following mark indicates that the grip lugs are insulated 





- In the standard series with front indicator, the front-mounted red indicator signals the tripping of a fuse
- LV HRC fuse links are always equipped with silver-plated contact pins. This means that they are non-corroding and have less contact resistance. This ensures the long-term operational safety of the plant

Technical specifications

	LV HRC fuse links						Operational class aM
	Operational class gG						
		3NA6...-4 3NA6...-4KK 3NA383-8	3NA6... 3NA6...-7 3NA7... 3NA7...-7	3NA3... 3NA3...-7	3NA6...-6 3NA7...-6	3NA3...-6	3ND1 3ND2
Standards		IEC 60269-1, -2; EN 60269-1; DIN VDE 0636					
Approvals		DIN VDE 0636-2; CSA 22.2 No.106, File No. 016325_0_00 (CSA approval of fuses 500 V for 600 V)					
Rated voltage U_n							
• Sizes 000 and 00	V AC	400	500	500	690 ¹⁾	690 ¹⁾	500
	V DC	--	250	250	250	250	--
• Sizes 1 and 2	V AC	400	500	500	690 ¹⁾	690 ¹⁾	690
	V DC	--	440	440	440	440	--
• Size 3	V AC	--	--	500	--	690 ¹⁾	690
	V DC	--	--	440	--	440	--
• Sizes 4 and 4a (IEC design)	V AC	--	--	500	--	--	--
	V DC	--	--	440	--	--	--
Rated current I_n	A	10 ... 400	2 ... 400	2 ... 1250	2 ... 315	2 ... 500	6 ... 630
Rated breaking capacity	kA AC	120					
	kA DC	--	25				--
Contact pins		Non-corroding, silver-plated					
Resistance to climate	°C	-20 ... +50 at 95% relative humidity					

¹⁾ Manufacturer's confirmation for 690 V +10% rated voltage available on request.





Selection and ordering data

Size	Mounting width mm	I_n A	U_n V AC/V DC	SD d	Insulated grip lugs		PU (UNIT, SET, M)	PS	PG						
					Article No. www.siemens.com/ product?Article No.	Price per PU									
LV HRC fuse links with combination alarm, operational class gG															
	000	21	400/--		10			1	3 units	1BM					
					16										
					20										
					25										
					32										
					35										
					40										
					50										
					63										
					80										
	00	30	400/--		80			1	3 units	1BM					
					100										
					125										
					160										
					160										
	1	30	400/--		35			1	3 units	1BM					
					40										
					50										
					63										
					80										
					100										
					125										
					160										
					47.2						200		1	3 units	1BM
					224										
250															
	2	47.2	400/--		50			1	3 units	1BM					
					63										
					80										
					100										
					125										
					160										
					200										
					224										
					250										
					57.8						300		1	3 units	1BM
315															
355															
400															





Fuse Systems

3NA, 3ND LV HRC Fuse Systems

LV HRC fuse links

Size	Mounting width mm	I_n A	U_n V AC/ V DC	SD d	Non-insulated grip lugs			Insulated grip lugs							
					Article No. www.siemens.com/product?Article No.	Price per PU	PU (UNIT, SET, M)	PS	PG SD d	Article No. www.siemens.com/product?Article No.	Price per PU	PU (UNIT, SET, M)	PS	PG	
LV HRC fuse links with combination alarm, operational class gG															
	000	21	2	500/250		3NA7802		1	3 units	1BM	3NA6802		1	3 units	1BM
						3NA7804		1	3 units	1BM	3NA6804		1	3 units	1BM
						3NA7801		1	3 units	1BM	3NA6801		1	3 units	1BM
						3NA7803		1	3 units	1BM	3NA6803		1	3 units	1BM
						3NA7805		1	3 units	1BM	3NA6805		1	3 units	1BM
						3NA7807		1	3 units	1BM	3NA6807		1	3 units	1BM
						3NA7810		1	3 units	1BM	3NA6810		1	3 units	1BM
						3NA7812		1	3 units	1BM	3NA6812		1	3 units	1BM
						3NA7814		1	3 units	1BM	3NA6814		1	3 units	1BM
						3NA7817		1	3 units	1BM	3NA6817		1	3 units	1BM
						3NA7820		1	3 units	1BM	3NA6820		1	3 units	1BM
						3NA7822		1	3 units	1BM	3NA6822		1	3 units	1BM
						3NA7824		1	3 units	1BM	3NA6824		1	3 units	1BM
3NA7830		1	3 units	1BM	3NA6830		1	3 units	1BM						
	00	30	80	500/250		3NA7824-7		1	3 units	1BM	3NA6824-7		1	3 units	1BM
						3NA7830-7		1	3 units	1BM	3NA6830-7		1	3 units	1BM
						3NA7832		1	3 units	1BM	3NA6832		1	3 units	1BM
						3NA7836		1	3 units	1BM	3NA6836		1	3 units	1BM
	1	30	16	500/440		3NA7105		1	3 units	1BM	3NA6105		1	3 units	1BM
			20			3NA7107		1	3 units	1BM	3NA6107		1	3 units	1BM
			25			3NA7110		1	3 units	1BM	3NA6110		1	3 units	1BM
			35			3NA7114		1	3 units	1BM	3NA6114		1	3 units	1BM
			40			3NA7117		1	3 units	1BM	3NA6117		1	3 units	1BM
			50			3NA7120		1	3 units	1BM	3NA6120		1	3 units	1BM
			63			3NA7122		1	3 units	1BM	3NA6122		1	3 units	1BM
			80			3NA7124		1	3 units	1BM	3NA6124		1	3 units	1BM
			100			3NA7130		1	3 units	1BM	3NA6130		1	3 units	1BM
			125			3NA7132		1	3 units	1BM	3NA6132		1	3 units	1BM
			160			3NA7136		1	3 units	1BM	3NA6136		1	3 units	1BM
			200			3NA7140		1	3 units	1BM	3NA6140		1	3 units	1BM
			224			3NA7142		1	3 units	1BM	3NA6142		1	3 units	1BM
250	3NA7144		1	3 units	1BM	3NA6144		1	3 units	1BM					
	2	47.2	35	500/440		3NA7214		1	3 units	1BM	3NA6214		1	3 units	1BM
			50			3NA7220		1	3 units	1BM	3NA6220		1	3 units	1BM
			63			3NA7222		1	3 units	1BM	3NA6222		1	3 units	1BM
			80			3NA7224		1	3 units	1BM	3NA6224		1	3 units	1BM
			100			3NA7230		1	3 units	1BM	3NA6230		1	3 units	1BM
			125			3NA7232		1	3 units	1BM	3NA6232		1	3 units	1BM
			160			3NA7236		1	3 units	1BM	3NA6236		1	3 units	1BM
			200			3NA7240		1	3 units	1BM	3NA6240		1	3 units	1BM
			224			3NA7242		1	3 units	1BM	3NA6242		1	3 units	1BM
			250			3NA7244		1	3 units	1BM	3NA6244		1	3 units	1BM
			300			--				3NA6250		1	3 units	1BM	
			315			3NA7252		1	3 units	1BM	3NA6252		1	3 units	1BM
			355			--				3NA6254		1	3 units	1BM	
400	3NA7260		1	3 units	1BM	3NA6260		1	3 units	1BM					





5

Size	Mounting width mm	I_n A	U_n V AC/V DC	SD d	Non-insulated grip lugs	Price per PU	PU (UNIT, SET, M)	PS	PG
					Article No. www.siemens.com/ product?Article No.				
LV HRC fuse links with front indicator, operational class gG									
	000	21	500/250		2			3 units	1BM
					4				
					6				
					10				
					16				
					20				
					25				
					32				
					35				
					40				
					50				
					63				
					80				
					100				
					125				
160									
	00	30	500/250		35			3 units	1BM
					50				
					63				
					80				
					100				
					125				
160									
	0	30	500/440		6			3 units	1BM
					10				
					16				
					20				
					25				
					32				
					35				
					40				
					50				
					63				
					80				
					100				
					125				
160									
	1	30	500/440		16			3 units	1BM
					20				
					25				
					35				
					40				
					50				
					63				
					80				
					100				
					125				
					160				
					200				
					224				
					250				
					224			3 units	1BM
					250			3 units	1BM





Fuse Systems

3NA, 3ND LV HRC Fuse Systems

LV HRC fuse links

Size	Mounting width mm	I_n A	U_n V AC/V DC	SD d	Non-insulated grip lugs		PU (UNIT, SET, M)	PS	PG
					Article No. www.siemens.com/ product?Article No.	Price per PU			
LV HRC fuse links with front indicator, operational class gG									
	2	47.2	500/440		3NA3214		1	3 units	1BM
					3NA3220		1	3 units	1BM
					3NA3222		1	3 units	1BM
					3NA3224		1	3 units	1BM
					3NA3230		1	3 units	1BM
					3NA3232		1	3 units	1BM
					3NA3236		1	3 units	1BM
					3NA3240		1	3 units	1BM
					3NA3242		1	3 units	1BM
					3NA3244		1	3 units	1BM
					3NA3250		1	3 units	1BM
					3NA3252		1	3 units	1BM
					3NA3254		1	3 units	1BM
					3NA3260		1	3 units	1BM
	3	57.8	500/440		3NA3340		1	3 units	1BM
					3NA3342		1	3 units	1BM
					3NA3344		1	3 units	1BM
					3NA3350		1	3 units	1BM
					3NA3352		1	3 units	1BM
					3NA3354		1	3 units	1BM
					3NA3360		1	3 units	1BM
					3NA3362		1	3 units	1BM
					3NA3365		1	3 units	1BM
					3NA3372		1	3 units	1BM
Can only be used for 3NH3530 LV HRC fuse base									
	4 (IEC design)	101.8	500/440		3NA3472		1	1 unit	1BM
					3NA3475		1	1 unit	1BM
					3NA3480		1	1 unit	1BM
					3NA3482		1	1 unit	1BM
Only for 3NH7520 LV HRC fuse base or usable for 3NJ5643-0BB00 fuse switch disconnectors with in-line design									
	4a	101.8	500/440		3NA3665		1	1 unit	1BM
					3NA3672		1	1 unit	1BM
					3NA3675		1	1 unit	1BM
					3NA3680		1	1 unit	1BM
					3NA3682		1	1 unit	1BM

5





Size	Mounting width	I_n	U_n	SD	Non-insulated grip lugs				Insulated grip lugs																
					Article No. www.siemens.com/product?Article No.	Price per PU	PU (UNIT, SET, M)	PS	PG	SD	Article No. www.siemens.com/product?Article No.	Price per PU	PU (UNIT, SET, M)	PS	PG										
	mm	A	V AC/ V DC	d																					
LV HRC fuse links with combination alarm, operational class gG																									
	000	21	2	690 ¹⁾	3NA7802-6		1	3 units	1BM	3NA6802-6		1	3 units	1BM											
				250														3NA7804-6	1	3 units	1BM	3NA6804-6	1	3 units	1BM
				6														3NA7801-6	1	3 units	1BM	3NA6801-6	1	3 units	1BM
				10														3NA7803-6	1	3 units	1BM	3NA6803-6	1	3 units	1BM
				16														3NA7805-6	1	3 units	1BM	3NA6805-6	1	3 units	1BM
				20														3NA7807-6	1	3 units	1BM	3NA6807-6	1	3 units	1BM
				25														3NA7810-6	1	3 units	1BM	3NA6810-6	1	3 units	1BM
				32														3NA7812-6	1	3 units	1BM	3NA6812-6	1	3 units	1BM
				35														3NA7814-6	1	3 units	1BM	3NA6814-6	1	3 units	1BM
				40														3NA7817-6KJ	1	3 units	1BM	3NA6817-6KJ	1	3 units	1BM
50	3NA7820-6KJ	1	3 units	1BM	3NA6820-6KJ	1	3 units	1BM																	
	00	30	40	690 ¹⁾	3NA7817-6		1	3 units	1BM	3NA6817-6		1	3 units	1BM											
				250														3NA7820-6	1	3 units	1BM	3NA6820-6	1	3 units	1BM
				63														3NA7822-6	1	3 units	1BM	3NA6822-6	1	3 units	1BM
				80														3NA7824-6	1	3 units	1BM	3NA6824-6	1	3 units	1BM
				100														3NA7830-6	1	3 units	1BM	3NA6830-6	1	3 units	1BM
	1	30	50	690 ¹⁾	3NA7120-6		1	3 units	1BM	3NA6120-6		1	3 units	1BM											
				440														3NA7122-6	1	3 units	1BM	3NA6122-6	1	3 units	1BM
				80														3NA7124-6	1	3 units	1BM	3NA6124-6	1	3 units	1BM
				100														3NA7130-6	1	3 units	1BM	3NA6130-6	1	3 units	1BM
				125														3NA7132-6	1	3 units	1BM	3NA6132-6	1	3 units	1BM
				160														3NA7136-6	1	3 units	1BM	3NA6136-6	1	3 units	1BM
				200														3NA7140-6	1	3 units	1BM	3NA6140-6	1	3 units	1BM
	2	47.2	80	690 ¹⁾	3NA7224-6		1	3 units	1BM	3NA6224-6		1	3 units	1BM											
				440														3NA7230-6	1	3 units	1BM	3NA6230-6	1	3 units	1BM
				125														3NA7232-6	1	3 units	1BM	3NA6232-6	1	3 units	1BM
				160														3NA7236-6	1	3 units	1BM	3NA6236-6	1	3 units	1BM
				200														3NA7240-6	1	3 units	1BM	3NA6240-6	1	3 units	1BM
				224														3NA7242-6	1	3 units	1BM	3NA6242-6	1	3 units	1BM
				250														3NA7244-6	1	3 units	1BM	3NA6244-6	1	3 units	1BM
				300														3NA7250-6	1	3 units	1BM	3NA6250-6	1	3 units	1BM
				315														3NA7252-6	1	3 units	1BM	3NA6252-6	1	3 units	1BM

¹⁾ Manufacturer's confirmation for 690 V +10% rated voltage available on request.





Fuse Systems

3NA, 3ND LV HRC Fuse Systems

LV HRC fuse links

Size	Mounting width mm	I_n A	U_n V AC/V DC	SD d	Non-insulated grip lugs	Price per PU	PU (UNIT, SET, M)	PS	PG
					Article No. www.siemens.com/ product?ArticleNo.				
LV HRC fuse links with front indicator, operational class gG									
	000	21	690 ¹⁾ /250		2			1 3 units	1BM
					4				
					6				
					10				
					16				
					20				
					25				
					32				
					35				
					40				
					50				
	00	30	690 ¹⁾ /250		40			1 3 units	1BM
					50				
					63				
					80				
					100				
	1	30	690 ¹⁾ /440		50			1 3 units	1BM
					63				
					80				
					100				
					125				
		47.2			160				
					200				
					250				
					▶ 3NA3140-6				
					▶ 3NA3144-6				
	2	47.2	690 ¹⁾ /440		80			1 3 units	1BM
					100				
					125				
					160				
					200				
		57.8			224				
					250				
					300				
					315				
					3NA3252-6				
	3	57.8	690 ¹⁾ /440		250			1 3 units	1BM
					315				
		71.2			355				
					400				
					425				
					500				
					3NA3365-6				

¹⁾ Manufacturer's confirmation for 690 V + 10% rated voltage available on request.

Size	Mounting width mm	I_n A	U_n V AC/V DC	SD d	Non-insulated grip lugs	Price per PU	PU (UNIT, SET, M)	PS	PG				
					Article No. www.siemens.com/ product?Article No.								
LV HRC fuse links with front indicator, operational class aM													
	000	21	6	500/--									
										10	3ND1803	1 3 units	1BM
										16	3ND1805	1 3 units	1BM
										20	3ND1807	1 3 units	1BM
										25	3ND1810	1 3 units	1BM
										32	3ND1812	1 3 units	1BM
										35	3ND1814	1 3 units	1BM
										40	3ND1817	1 3 units	1BM
										50	3ND1820	1 3 units	1BM
										63	3ND1822	1 3 units	1BM
80	3ND1824	1 3 units	1BM										
100	3ND1830-8	1 3 units	1BM										
	00	30	100	500/--									
			125							3ND1830	1 3 units	1BM	
			160							3ND1832 3ND1836	1 3 units 1 3 units	1BM 1BM	
	1	30	63	690/--									
			80							3ND2122	1 3 units	1BM	
			100							3ND2124	1 3 units	1BM	
			125							3ND2130	1 3 units	1BM	
			160							3ND2132 3ND2136	1 3 units 1 3 units	1BM 1BM	
			200							3ND2140	1 3 units	1BM	
250	3ND2144	1 3 units	1BM										
	2	47.2	125	690/--									
			160							3ND2232	1 3 units	1BM	
			200							3ND2236	1 3 units	1BM	
			250							3ND2240 3ND2244	1 3 units 1 3 units	1BM 1BM	
			315							3ND2252	1 3 units	1BM	
355	3ND2254	1 3 units	1BM										
400	3ND2260	1 3 units	1BM										
	3	57.8	315	690/--									
			355							3ND2352	1 3 units	1BM	
			400							3ND2354	1 3 units	1BM	
			500							3ND2360	1 3 units	1BM	
630	3ND1365 3ND1372	1 3 units 1 3 units	1BM 1BM										

Fuse Systems

3NA, 3ND LV HRC Fuse Systems

LV HRC signal detectors

Overview

LV HRC signal detectors are used for remotely indicating that the LV HRC fuse links have been tripped. Three different solutions are available:

- 3NX1021 signal detectors with signal detector link
The LV HRC signal detectors with signal detector link support monitoring of LV HRC fuse links with non-insulated grip lugs of sizes 000 to 4 at 10 A or more. The signal detector link is connected in parallel to the LV HRC fuse link. In the event of a fault, the LV HRC fuse links are released simultaneously with the LV HRC fuse detector link. A trip pin switches a floating microswitch.

- 3NX1024 signal detector top
The signal detector top can be used with LV HRC fuse links, sizes 000, 00, 1 and 2, which are equipped with non-insulated grip lugs and have a front indicator or combination alarm. It is simply plugged into the grip lugs.
- 5TT3170 fuse monitor
If a fuse is tripped, the front indicator springs open and switches a floating microswitch. This solution should not be used for safety-relevant systems. For this purpose, we recommend our electronic fuse monitors.

5

Benefits



Uniform solution for all sizes

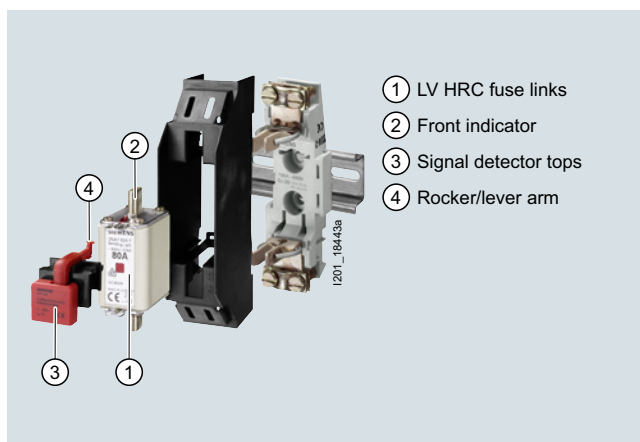
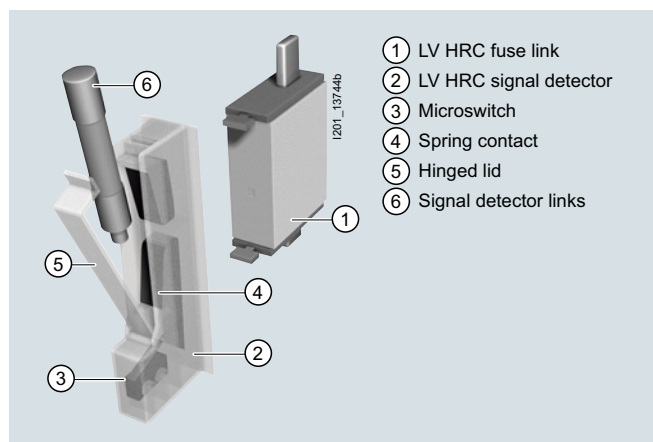

LV HRC signal detectors reliably indicate when a fuse has tripped. Tripped fuses are quickly located. This saves time and increases system availability.

The LV HRC signal detector top is a cost-effective solution for the monitoring of Siemens LV HRC fuse links of sizes 000, 00, 1 and 2.



Selection and ordering data

	Size	SD	Article No. www.siemens.com/ product?Article No.	Price per PU	PU (UNIT, SET, M)	PS	PG
	000 ... 4	d	3NX1021		1	1 unit	1BM
LV HRC signal detectors Only for SIEMENS 3NA3, 3NA7, 3ND LV HRC fuse links with non-insulated grip lugs							
<ul style="list-style-type: none"> • Rated voltage up to 690 V AC/600 V DC • Contact: Microswitches 250 V AC, 6 A • Connection: Flat connector 2.3 mm 							
	000 ... 4		3NX1022		1	3 units	1BM
Signal detector links							
<ul style="list-style-type: none"> • Rated voltage up to 690 V AC/600 V DC 							
Response value > 9 V; 2.5 A; for standard applications							
Response value > 2 V; 7 A; only for meshed networks							
	000, 00, 1, 2		3NX1024		1	1 unit	1BM
Signal detector tops							
Only for SIEMENS 3NA3, 3NA7, 3ND LV HRC fuse links with non-insulated grip lugs							
<ul style="list-style-type: none"> • Rated voltage up to 690 V AC/600 V DC • Contact: Microswitch 230 V AC, 5 A, 1 CO • Connection: Flat connector 2.3 mm 							

U_e	I_n	U_c	Mounting width	SD	Article No. www.siemens.com/ product?Article No.	Price per PU	PU (UNIT, SET, M)	PS	PG
V AC	A	V	MW	d					
	230	4	380 ... 415	3 AC	5TT3170		1	1 unit	1BK
Fuse monitors									
For all low-voltage fuse systems.									
Can be used in asymmetric systems afflicted with harmonics and regenerative feedback motors.									
Signal also for disconnected loads.									
Electronic fuse monitoring for remote display of tripped fuses: 3KF9010-1AA00, see chapter "Switch Disconnectors".									
									

Fuse Systems

3NA, 3ND LV HRC Fuse Systems

LV HRC fuse bases and accessories

Overview

Terminals for all applications

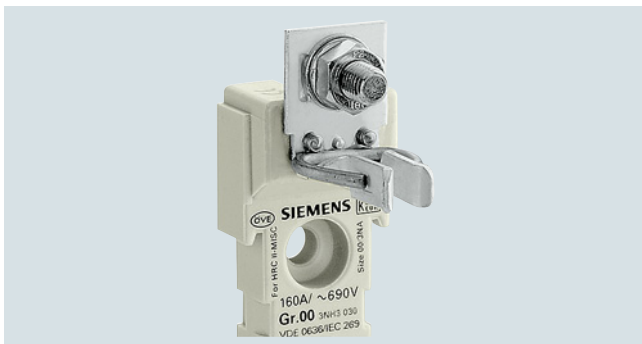

Flat terminals with screws are suitable for connecting busbars or cable lugs. They have a torsion-proof screw connection with shim, spring washer and nut. When tightening the nut, always ensure compliance with the specified torque due to the considerable leverage effect.

The double busbar terminal differs from the flat terminal in that it supports connection of two busbars, one on the top and one at the bottom of the flat terminal.

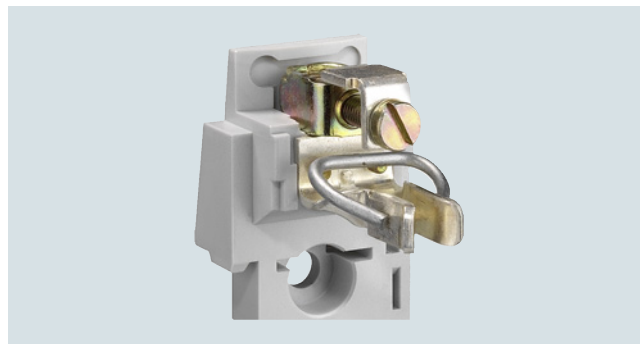

The modern box terminal ensures efficient and reliable connection to the conductors. They support connection of conductors with or without end sleeves.



The plug-in terminal is equipped for connecting two conductors.

Benefits

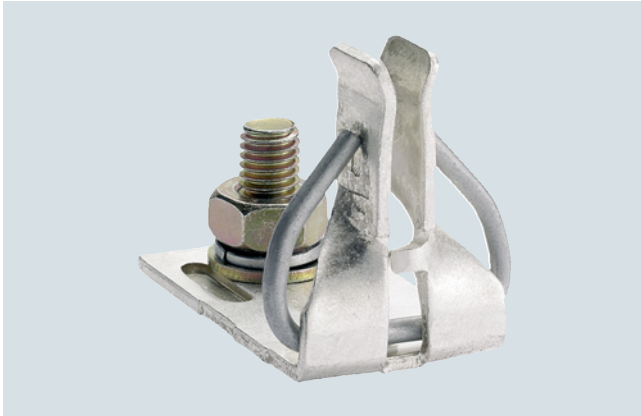

- The silver-plated Lyra contact provides a large contact area for the pin of the LV HRC fuse link. This improves heat transmission and lowers the temperature. It also minimizes aging of the fuse link in the maximum load range, in particular when using SITOR semiconductor fuses
- The large contact area also facilitates replacement of LV HRC fuse links
- The spring washer tensioning the contact is mechanically galvanized. This will prevent hydrogen embrittlement. The contact is resistant to aging and there will be no dreaded annealing of contacts, which considerably improves operating safety

5

Technical specifications

Size	LV HRC fuse bases, LV HRC bus-mounting bases						
	000/00	0	1	2	3	4	
Standards	IEC 60269-1, -2; EN 60269-1; DIN VDE 0636-2, UL 4248-1 (only downstream from the branch protection)						
Approvals	KEMA, UL File No. E171267-IZLT2						
Rated current I_n	A	160	160	250	400	630	1250
Rated voltage U_n	V AC	690 ¹⁾	690 ¹⁾				690
	V DC	250	440				440
Rated short-circuit strength	kA AC	120					
	kA DC	25					
Max. power dissipation of fuse links	W	12	25	32	45	60	90
Flat terminal							
Screw		M8		M10		M12	
Nut		M8	--				
Max. tightening torque	Nm	14		38			65
Plug-in terminal							
Conductor cross-section	mm ²	2.5 ... 50		--			
Saddle-type terminal							
Conductor cross-section	mm ²	6 ... 70	--				
Box terminal							
Conductor cross-section	mm ²	2.5 ... 50					
Terminal strips							
Conductor cross-section, 3-wire	mm ²	1.5 ... 16	--				
Max. torque for attachment of LV HRC fuse base	Nm	8		15			--

¹⁾ Extended rated voltage up to 1000 V (except LV HRC bus-mounting bases).







Size	LV HRC fuse bases with swivel mechanism			
	000/00	1	3	4a
Rated voltage U_n	V AC	690		
	V DC	440		
Rated conditional short-circuit current	kA	--		80
Rated short-time withstand current / 1s	kA	--		35
Max. power dissipation of fuse links	W	12	32	48
Flat terminal				
Screw		M8	M10	M12
Nut		M8	--	
Max. tightening torque	Nm	14	38	65

Fuse Systems

3NA, 3ND LV HRC Fuse Systems



LV HRC fuse bases and accessories

Selection and ordering data

Size	I_n	Version	SD	Article No. www.siemens.com/ product?Article No.	Price per PU	PU (UNIT, SET, M)	PS	PG
	A		d					
LV HRC fuse bases								
Made of molded plastic, for standard rail mounting or screw fixing								
	000/00	160	1P With flat terminals, screw	3NH3051		1	1 unit	1BM
Made of ceramic for screw fixing								
	000/00	160	1P With flat terminals, screw With plug-in terminals With saddle-type terminals	3NH3030 3NH3031 3NH3032		1 1 1	3 units 3 units 3 units	1BM 1BM 1BM
			3P (incl. two partitions) With flat terminals With saddle-type terminals	3NH4030 3NH4032		1 1	1 unit 1 unit	1BM 1BM
Made of ceramic for screw fixing								
	0	160	1P With flat terminals	3NH3120		1	3 units	1BM
Made of ceramic for screw fixing								
	1	250	1P With flat terminals With double busbar terminals	3NH3230 3NH3220		1 1	3 units 3 units	1BM 1BM
Ceramic supports on base plate for screw fixing								
	1	250	3P (incl. two partitions) With flat terminals	3NH4230		1	1 unit	1BM
Made of ceramic for screw fixing								
	2	400	1P With flat terminals With double busbar terminals	3NH3330 3NH3320		1 1	1 unit 1 unit	1BM 1BM
Made of ceramic for screw fixing								
	3	630	1P With flat terminals With double busbar terminals	3NH3430 3NH3420		1 1	1 unit 1 unit	1BM 1BM

5

LV HRC fuse bases and accessories





Size	I_n	Version	SD	Article No. www.siemens.com/ product?Article No.	Price per PU	PU (UNIT, SET, M)	PS	PG
A			d					
LV HRC fuse bases								
Ceramic supports on base plate for screw fixing (IEC design)								
	4	1250	1P	With flat terminals	3NH3530	1	1 unit	1BM
LV HRC fuse bases with swivel mechanism								
With flat terminals ¹⁾								
	000/00	160	1P	With screw fixing for mounting plate	3NH7030	1	1 unit	1BM
	1	250	1P	With screw fixing for mounting plate	3NH7230	1	1 unit	1BM
Can also be used for fuse links of size 2								
	3	630	1P	With screw fixing for mounting plate	3NH7330	1	1 unit	1BM







¹⁾ Size 000/00 with additionally enclosed saddle-type terminals

Fuse Systems

3NA, 3ND LV HRC Fuse Systems

LV HRC fuse bases and accessories

	Size	I_n	Version	SD	Article No. www.siemens.com/ product?Article.No.	Price per PU	PU (UNIT, SET, M)	PS	PG
	A			d					
	LV HRC fuse bases with swivel mechanism 4a	1250	1P With screw fixing for mounting plate		3NH7520		1	1 unit	1BM
	LV HRC contact covers for LV HRC fuse bases As touch protection for contact pieces								
	000/00				3NX3105		1	2 units	1BM
	0				3NX3114		1	2 units	1BM
	1				3NX3106		1	2 units	1BM
	2				3NX3107		1	2 units	1BM
	3				3NX3108		1	2 units	1BM
	LV HRC partitions for LV HRC fuse bases As intermediate phase and end barrier		Type						
	000/00		3NH30/3NH40		3NX2023		1	2 units	1BM
	0		3NH31		3NX2030		1	2 units	1BM
	1		3NH32		3NX2024		1	2 units	1BM
	2		3NH33		3NX2025		1	2 units	1BM
	3		3NH34		3NX2026		1	2 units	1BM
	LV HRC contact covers 000/00		1P and 3P		3NX3115		1	10 units	1BM
	000/00		When using fuse links with non-insulated grip lugs		3NX3116		1	10 units	1BM

Size	Version	SD	Article No. www.siemens.com/ product?Article No.	Price per PU	PU (UNIT, SET, M)	PS	PG
Fuse base covers							
For LV HRC fuse bases, red, with inscription "Isolating point"							
000/00							
1¹⁾, 2, 3							
1) Note: Restriction: Observe width 60 mm of the blank insert when using for LV HRC fuse bases or LV HRC fuse switching devices of size 1!							
		d	3NX1003 3NX1004		1 1	3 units 3 units	1BM 1BM
Fuse pullers							
000 to 3							
For LV HRC fuse links							
Without sleeve							
With sleeve							
			3NX1013 3NX1014		1 1	1 unit 1 unit	1BM 1BM
							
Isolating blades							
For LV HRC fuse bases and fuse switch disconnectors							
With insulated grip lugs							
000/00							
0 Silver-plated							
1							
2							
3							
			3NG1002 3NG1102 3NG1202 3NG1302 3NG1402		1 1 1 1 1	3 units 1 unit 1 unit 1 unit 1 unit	1BM 1BM 1BM 1BM 1BM
With non-insulated grip lugs							
4 Tin-coated							
4a Nickel-plated							
			3NG1503 3NG1505		1 1	3 units 1 unit	1BM 1BM

Fuse Systems

3NA, 3ND LV HRC Fuse Systems

LV HRC fuse bases and accessories

SITOR semiconductor fuses for 3NH bases: Assignment table

3NH bases are generally suitable for all LV HRC type fuses. LV HRC type fuses for SITOR semiconductor protection can also be used, although it must be noted that, compared to cable and line protection fuses, these get much hotter during operation. The following table contains the permissible load currents of the SITOR semiconductor fuses for installation in 3NH.

For installation in a base, it may therefore be necessary to operate the fuse under I_n (derating).

The values were determined using the conductor cross-sections specified in the table. If using smaller cross-sections, a considerably higher derating is required due to the lower heat dissipation.

SITOR semiconductor fuse data						Permissible load currents of fuse when installed in: 3NH		
Type ¹⁾	Rated current I_n	Rated voltage U_n	Operational class	Size	Required conductor cross-section	Type	Size	Permissible load current ²⁾
--	A	V AC	--	--	mm ² Cu	--	--	A
3NC2423-0C/3C	150	500	gR	3	70	3NH3430/20	3	150
3NC2425-0C/3C	200	500	gR	3	95	3NH3430/20	3	190
3NC2427-0C/3C	250	500	gR	3	120	3NH3430/20	3	240
3NC2428-0C/3C	300	500	gR	3	185	3NH3430/20	3	285
3NC2431-0C/3C	350	500	gR	3	240	3NH3430/20	3	330
3NC2432-0C/3C	400	500	aR	3	240	3NH3430/20	3	400
3NC3336-1U	630	1000	aR	3	2 x (40 x 5)	3NH3430/20	3	560
3NC3337-1U	710	1000	aR	3	2 x (50 x 5)	3NH3430/20	3	600
3NC3338-1U	800	1000	aR	3	2 x (40 x 8)	3NH3430/20	3	660
3NC3340-1U	900	1000	aR	3	2 x (40 x 8)	3NH3430/20	3	750
3NC3341-1U	1000	1000	aR	3	2 x (50 x 8)	3NH3430/20	3	850
3NC3342-1U	1100	800	aR	3	2 x (50 x 8)	3NH3430/20	3	900
3NC3343-1U	1250	800	aR	3	2 x (50 x 8)	3NH3430/20	3	950
3NC3430-1U	315	1250	aR	3	2 x 95	3NH3430/20	3	310
3NC3432-1U	400	1250	aR	3	2 x 120	3NH3430/20	3	390
3NC3434-1U	500	1250	aR	3	2 x 150	3NH3430/20	3	460
3NC3436-1U	630	1250	aR	3	2 x (40 x 5)	3NH3430/20	3	560
3NC3438-1U	800	1100	aR	3	2 x (40 x 8)	3NH3430/20	3	690
3NC8423-0C/3C	150	690	gR	3	70	3NH3430/20	3	135
3NC8425-0C/3C	200	690	gR	3	95	3NH3430/20	3	180
3NC8427-0C/3C	250	690	gR	3	120	3NH3430/20	3	250
3NC8431-0C/3C	350	690	gR	3	240	3NH3430/20	3	315
3NC8434-0C/3C	500	690	gR	3	2 x 150	3NH3430/20	3	450
3NC8444-3C	1000	600	aR	3	2 x (60 x 6)	3NH3430/20	3	800
3NE1020-2	80	690	gR	00	25	3NH3030/4030	00	80
3NE1021-0	100	690	gS	00	35	3NH3030/4030	00	100
3NE1021-2	100	690	gR	00	35	3NH3030/4030	00	100
3NE1022-0	125	690	gS	00	50	3NH3030/4030	00	125
3NE1022-2	125	690	gR	00	50	3NH3030/4030	00	125
3NE1224-0	160	690	gS	1	70	3NH3230/4230	1	160
3NE1224-2/-3	160	690	gR	1	70	3NH3230/4230	1	160
3NE1225-0	200	690	gS	1	95	3NH3230/4230	1	200
3NE1225-2/-3	200	690	gR	1	95	3NH3230/4230	1	200/190
3NE1227-0	250	690	gS	1	120	3NH3230/4230	1	250
3NE1227-2/-3	250	690	gR	1	120	3NH3230/4230	1	250/235
3NE1230-0	315	690	gS	1	2 x 70	3NH3330/20	2	315
3NE1230-2/-3	315	690	gR	1	2 x 70	3NH3330/20	2	315
3NE1331-0	350	690	gS	2	2 x 95	3NH3330/20	2	350
3NE1331-2/-3	350	690	gR	2	2 x 95	3NH3330/20	2	350
3NE1332-0	400	690	gS	2	2 x 95	3NH3330/20	2	400
3NE1332-2/-3	400	690	gR	2	2 x 95	3NH3330/20	2	400
3NE1333-0	450	690	gS	2	2 x 120	3NH3430/20	3	450
3NE1333-2/-3	450	690	gR	2	2 x 120	3NH3430/20	3	450
3NE1334-0	500	690	gS	2	2 x 120	3NH3430/20	3	500
3NE1334-2/-3	500	690	gR	2	2 x 120	3NH3430/20	3	500
3NE1435-0	560	690	gS	3	2 x 150	3NH3430/20	3	560
3NE1435-2/-3	560	690	gR	3	2 x 150	3NH3430/20	3	560
3NE1436-0	630	690	gS	3	2 x 185	3NH3430/20	3	630
3NE1436-2/-3	630	690	gR	3	2 x 185	3NH3430/20	3	630
3NE1437-0	710	690	gS	3	2 x (40 x 5)	3NH3430/20	3	710
3NE1437-1	710	600	gR	3	2 x (40 x 5)	3NH3430/20	3	690
3NE1437-2/-3	710	690	gR	3	2 x (40 x 5)	3NH3430/20	3	710
3NE1438-0	800	690	gS	3	2 x (50 x 5)	3NH3430/20	3	800
3NE1438-1	800	600	gR	3	2 x (50 x 5)	3NH3430/20	3	750
3NE1438-2/-3	800	690	gR	3	2 x (50 x 5)	3NH3430/20	3	800
3NE1447-2/-3	670	690	gR	3	2 x (40 x 5)	3NH3430/20	3	670
3NE1448-2/-3	850	690	gR	3	2 x (40 x 8)	3NH3430/20	3	850
3NE1802-0	40	690	gS	000	10	3NH3030/4030	00	40

¹⁾ For permissible load currents for 3NE8...-0MK, see Configuration Manual "Fuse Systems" in SIOS or on request.

²⁾ In the case of cyclic loads, the currents may have to be further reduced (precise values on request).

SITOR semiconductor fuse data						Permissible load currents of fuse when installed in: 3NH		
Type ¹⁾	Rated current I_n	Rated voltage U_n	Operational class	Size	Required conductor cross-section	Type	Size	Permissible load current ²⁾
--	A	V AC	--	--	mm ² Cu	--	--	A
3NE1803-0	35	690	gS	000	6	3NH3030/4030	00	35
3NE1813-0	16	690	gS	000	1.5	3NH3030/4030	00	16
3NE1814-0	20	690	gS	000	2.5	3NH3030/4030	00	20
3NE1815-0	25	690	gS	000	4	3NH3030/4030	00	25
3NE1817-0	50	690	gS	000	10	3NH3030/4030	00	50
3NE1818-0	63	690	gS	000	16	3NH3030/4030	00	63
3NE1820-0	80	690	gS	000	25	3NH3030/4030	00	80
3NE3221	100	1000	aR	1	35	3NH3230/4230	1	100
3NE3222	125	1000	aR	1	50	3NH3230/4230	1	125
3NE3224	160	1000	aR	1	70	3NH3230/4230	1	160
3NE3225	200	1000	aR	1	95	3NH3230/4230	1	200
3NE3227	250	1000	aR	1	120	3NH3230/4230	1	250
3NE3230-0B	315	1000	aR	1	185	3NH3330/20	2	305
3NE3231	350	1000	aR	1	240	3NH3330/20	2	335
3NE3232-0B	400	1000	aR	1	240	3NH3330/20	2	380
3NE3233	450	1000	aR	1	2 x 150	3NH3330/20	2	425
3NE3332-0B	400	1000	aR	2	240	3NH3430/20	3	400
3NE3333	450	1000	aR	2	2 x 150	3NH3430/20	3	450
3NE3334-0B	500	1000	aR	2	2 x 150	3NH3430/20	3	500
3NE3335	560	1000	aR	2	2 x 185	3NH3430/20	3	560
3NE3336	630	1000	aR	2	2 x 185	3NH3430/20	3	630
3NE3337-8	710	900	aR	2	2 x (40 x 5)	3NH3430/20	3	680
3NE3338-8	800	800	aR	2	2 x 240	3NH3430/20	3	700
3NE3340-8	900	690	aR	2	2 x (40 x 8)	3NH3430/20	3	750
3NE4101	32	1000	gR	0	6	3NH3120/4230	0/1	32
3NE4102	40	1000	gR	0	10	3NH3120/4230	0/1	40
3NE4117	50	1000	gR	0	10	3NH3120/4230	0/1	50
3NE4118	63	1000	aR	0	16	3NH3120/4230	0/1	63
3NE4120	80	1000	aR	0	25	3NH3120/4230	0/1	80
3NE4121	100	1000	aR	0	35	3NH3120/4230	0/1	100
3NE4122	125	1000	aR	0	50	3NH3120/4230	0/1	125
3NE4124	160	1000	aR	0	70	3NH3120/4230	0/1	160
3NE4327-0B	250	800	aR	2	150	3NH3330/20	2	240
3NE4330-0B	315	800	aR	2	240	3NH3330/20	2	300
3NE4333-0B	450	800	aR	2	2 x (30 x 5)	3NH3430/20	3	425
3NE4334-0B	500	800	aR	2	2 x (30 x 5)	3NH3430/20	3	475
3NE4337	710	800	aR	2	2 x (50 x 5)	3NH3430/20	3	630
3NE8015-1	25	690	gR	00	4	3NH3030/4030	00	25
3NE8003-1	35	690	gR	00	6	3NH3030/4030	00	35
3NE8017-1	50	690	gR	00	10	3NH3030/4030	00	50
3NE8018-1	63	690	gR	00	16	3NH3030/4030	00	63
3NE8020-1	80	690	aR	00	25	3NH3030/4030	00	80
3NE8021-1	100	690	aR	00	35	3NH3030/4030	00	100
3NE8022-1	125	690	aR	00	50	3NH3030/4030	00	125
3NE8024-1	160	690	aR	00	70	3NH3030/4030	00	160

¹⁾ For permissible load currents for 3NE8...-0MK, see [Configuration Manual "Fuse Systems"](#) in SIOS or on request.

²⁾ In the case of cyclic loads, the currents may have to be further reduced (precise values on request).

Fuse Systems

SITOR Semiconductor Fuses

LV HRC design

Overview

SITOR semiconductor fuses protect power semiconductors from the effects of short circuits because the super quick-response disconnect characteristic is far quicker than with conventional LV HRC fuses. They protect high-quality devices and system components, such as converters with fuses in the input and the DC link, UPS systems and soft starters for motors.

Panel mounting requirements have given rise to various connection versions and designs.

The fuses with blade contacts comply with IEC 60269-2 and are suitable for installation in 3NH LV HRC fuse bases, in LV HRC fuse switch disconnectors and switch disconnectors with fuses. They also include fuses with slotted blade contacts for screw fixing with 110 mm mounting dimension, whose sizes are according to IEC 60269-4.

Fuses with slotted blade contacts for screw fixing with 80 mm or 110 mm mounting dimension are often screwed directly onto busbars for optimum heat dissipation. Even better heat transmission is provided by the compact fuses with M10 or M12 female thread, which are also mounted directly onto busbars.

Bolt-on links with 80 mm mounting dimension are another panel-mounting version for direct busbar mounting.

The fuses for SITOR thyristor sets, railway rectifiers or electrolysis systems were developed specially for these applications.

Information about 3NH LV HRC fuse bases suitable for use with SITOR semiconductor fuses can also be found in this chapter, see [page 5/48 onwards](#).

Note:

For detailed information about 3KF and 3NP switch disconnectors, see chapter "Switch Disconnectors", sections "Switch Disconnectors with Fuses"/"Fuse Switch Disconnectors". Please note that the newly developed 3KF SITOR switch disconnectors have been specially provided with heat sinks to accommodate the higher temperatures of the SITOR fuses.

Fuse characteristics, configuration notes and the assignments of SITOR semiconductor fuses to the fuse bases and 3NP fuse switch disconnectors and 3KF switch disconnectors with fuses can be found in the Configuration Manual "Fuse Systems" in SIOS at: www.siemens.com/lowvoltage/manuals.

The new size 3 type ranges have a round ceramic body instead of a square one. These series are characterized by small I^2t values with low power dissipation and high capability under alternating load. The dimensions and functional values correspond to the current standards IEC 60269-4/EN 60269-4 (VDE 0636-4).

Note:

The ordering data of the fuses are listed in ascending order of the rated voltage in the selection tables.

Benefits

- SITOR semiconductor fuses have a high varying load factor, which ensures a high level of operational safety and plant availability – even when subject to constant load change
- The use of SITOR semiconductor fuses in 3NH LV HRC fuse bases or Siemens switch disconnectors has been tested with regard to heat dissipation and maximum current loading. This makes planning and dimensioning easier and prevents consequential damage
- Our high standard of quality ensures good compliance with the characteristic curve and accuracy. This ensures long-term protection of devices

Operational classes







Fuses are categorized according to function and operational classes. SITOR semiconductor fuses, in LV HRC design, are available in the following operational classes:

- aR: For the short-circuit protection of power semiconductors (partial range protection)
- gR: For the protection of power semiconductors (full range protection)
- gS: The gS operational class combines cable and line protection with semiconductor protection (full range protection)

Parallel-connected fuses

Parallel-connected fuses offer maximum current and energy limiting that is clearly better than in the case of comparable single fuses. They also fulfill the special requirements for UL-certified fuses according to which fuses must be connected in parallel at the factory. *Here is the original wording of the NEC document: 240.8 Fuses and circuit breakers shall be permitted to be connected in parallel where they are factory assembled in parallel and listed as a unit. Individual fuses, circuit breakers, or combinations thereof shall not otherwise be connected in parallel.*









Selection and ordering data





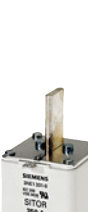

Size	I_n	U_n	Operational class	Breaking value	Power loss	Varying load factor WL	SD	Article No. www.siemens.com/product?Article No.	Price per PU	PU (UNIT, SET, M)	PS	PG
A		V AC/ V DC		A ² s	W		d					
LV HRC design												
With slotted blade contacts with 2 oblong slots for M10 screw fixing, mounting dimension: 110 mm, or for installation in 3NH3 LV HRC fuse bases or switch disconnectors (see page 5/56)												
	3	150	500	gR	33000	35	0.85	3NC2423-0C		1	3 units	1DM
		200			64000	40	0.85	3NC2425-0C		1	3 units	1DM
		250			99000	50	0.85	3NC2427-0C		1	3 units	1DM
		300			132000	65	0.85	3NC2428-0C		1	3 units	1DM
		350			249000	60	0.85	3NC2431-0C		1	3 units	1DM
		400		aR	390000	50	0.85	3NC2432-0C		1	3 units	1DM
With slotted blade contacts for M10 screw fixing, mounting dimension: 110 mm, or for installation in 3NH3 LV HRC fuse bases or switch disconnectors (see page 5/56)												
	3	150	500	gR	33000	35	0.85	3NC2423-3C		1	3 units	1DM
		200			64000	40	0.85	3NC2425-3C		1	3 units	1DM
		250			99000	50	0.85	3NC2427-3C		1	3 units	1DM
		300			132000	65	0.85	3NC2428-3C		1	3 units	1DM
		350			249000	60	0.85	3NC2431-3C		1	3 units	1DM
		400		aR	390000	50	0.85	3NC2432-3C		1	3 units	1DM
	1	160	690	gR	18600	32	1.0	3NE1224-3		1	3 units	1DM
		200			51 800	35	1.0	3NE1225-3		1	3 units	1DM
		250			80 900	37	1.0	3NE1227-3		1	3 units	1DM
		315			168 000	40	1.0	3NE1230-3		1	3 units	1DM
	2	350	690	gR	177000	43	1.0	3NE1331-3		1	3 units	1DM
		400			224000	50	1.0	3NE1332-3		1	3 units	1DM
		450			276500	58	1.0	3NE1333-3		1	3 units	1DM
		500			398000	64	1.0	3NE1334-3		1	3 units	1DM
	3	150	690	gR	17600	40	0.85	3NC8423-3C		1	3 units	1DM
		200			38400	55	0.85	3NC8425-3C		1	3 units	1DM
		250			70400	72	0.85	3NC8427-3C		1	3 units	1DM
		350			176000	95	0.85	3NC8431-3C		1	3 units	1DM
		500			448000	130	0.85	3NC8434-3C		1	3 units	1DM
		1000	600	aR	2480000	140	0.95	3NC8444-3C		1	3 units	1DM
With slotted blade contacts for M12 screw fixing, mounting dimension: 110 mm, or for installation in 3NH3 LV HRC fuse bases or switch disconnectors (see page 5/56)												
	3	560	690	gR	890000	60	1.0	3NE1435-3		1	3 units	1DM
		630			1390000	60	1.0	3NE1436-3		1	3 units	1DM
		670			1640000	64	1.0	3NE1447-3		1	3 units	1DM
		710			1818000	72	1.0	3NE1437-3		1	3 units	1DM
		800			2475000	84	1.0	3NE1438-3		1	3 units	1DM
		850			3640000	76	1.0	3NE1448-3		1	3 units	1DM
With M8 bolt-on links, mounting dimension: 80 mm, for screwing onto busbars or onto 3NH5423 fuse base												
	1	100	690/	aR	3200	25	On req.	3NE8221-3MK		1	3 units	1DM
		125	440		6000	28	On req.	3NE8222-3MK		1	3 units	1DM
		160			10500	35	On req.	3NE8224-3MK		1	3 units	1DM
		200			17500	42	On req.	3NE8225-3MK		1	3 units	1DM
		250			28500	53.5	On req.	3NE8227-3MK		1	3 units	1DM
		315			53500	61	On req.	3NE8230-3MK		1	3 units	1DM
		350			66000	69	On req.	3NE8231-3MK		1	3 units	1DM
		400			110000	70.5	On req.	3NE8232-3MK		1	3 units	1DM
		450			180000	71	On req.	3NE8233-3MK		1	3 units	1DM
		500			215000	84	On req.	3NE8234-3MK		1	3 units	1DM
		550			290000	87	On req.	3NE8235-3MK		1	3 units	1DM
		630			440000	96	On req.	3NE8236-3MK		1	3 units	1DM

Fuse Systems

SITOR Semiconductor Fuses

LV HRC design



Size	I_n	U_n	Operational class	Breaking value	Power loss	Varying load factor WL	SD	Article No. www.siemens.com/ product?Article No.	Price per PU	PU (UNIT, SET, M)	PS	PG
A		VAC		A^2s	W		d					
LV HRC design												
With slotted blade contacts for M12 screw fixing, mounting dimension: 80 mm												
	3	630	690	aR	244000	120	0.85	3NC3236-1U		1	3 units	1DM
		710			346000	130	0.85	3NC3237-1U		1	3 units	1DM
		800			498000	135	0.9	3NC3238-1U		1	3 units	1DM
		900			677000	145	0.9	3NC3240-1U		1	3 units	1DM
		1000			975000	155	0.95	3NC3241-1U		1	3 units	1DM
		1100			1382000	165	0.95	3NC3242-1U		1	3 units	1DM
		1250			1990000	175	0.95	3NC3243-1U		1	3 units	1DM
		1400	500		2100000	200	0.95	3NC3244-1U		1	3 units	1DM
		1600			2860000	240	0.9	3NC3245-1U		1	3 units	1DM
	With slotted blade contacts with 2 oblong slots for M10 screw fixing, mounting dimension: 110 mm, or for installation in 3NH3 LV HRC fuse bases or switch disconnectors (see page 5/56)											
	3	150	690	gR	17600	40	0.85	3NC8423-0C		1	3 units	1DM
		200			38400	55	0.85	3NC8425-0C		1	3 units	1DM
		250			70400	72	0.85	3NC8427-0C		1	3 units	1DM
		350			176000	95	0.85	3NC8431-0C		1	3 units	1DM
		500			448000	130	0.85	3NC8434-0C		1	3 units	1DM
With blade contacts for mounting in 3NH3 LV HRC fuse bases or switch disconnectors (see page 5/56)												
	3	710	600	gR	2460000	65	1.0	3NE1437-1		1	3 units	1DM
		800			3350000	72	1.0	3NE1438-1		1	3 units	1DM
	000	16	690	gS	200	4.0	1.0	3NE1813-0		1	3 units	1DM
		20			430	5.0	1.0	3NE1814-0		1	3 units	1DM
		25			780	5.0	1.0	3NE1815-0		1	3 units	1DM
		35			1700	3.5	1.0	3NE1803-0		1	3 units	1DM
		40			3000	3.0	1.0	3NE1802-0		1	3 units	1DM
		50			4400	6.0	1.0	3NE1817-0		1	3 units	1DM
		63			9000	7.0	1.0	3NE1818-0		1	3 units	1DM
		80			18000	8.0	1.0	3NE1820-0		1	3 units	1DM
	00	100	690	gS	33000	10	1.0	3NE1021-0		1	3 units	1DM
		125			63000	11	1.0	3NE1022-0		1	3 units	1DM
	1	160	690	gS	60000	24	1.0	3NE1224-0		1	3 units	1DM
		200			100000	27	1.0	3NE1225-0		1	3 units	1DM
		250			200000	30	1.0	3NE1227-0		1	3 units	1DM
		315			310000	38	1.0	3NE1230-0		1	3 units	1DM
	2	350	690	gS	430000	42	1.0	3NE1331-0		1	3 units	1DM
		400			590000	45	1.0	3NE1332-0		1	3 units	1DM
		450			750000	53	1.0	3NE1333-0		1	3 units	1DM
		500			950000	56	1.0	3NE1334-0		1	3 units	1DM
	3	560	690	gS	1700000	50	1.0	3NE1435-0		1	3 units	1DM
		630			2350000	55	1.0	3NE1436-0		1	3 units	1DM
		710			3400000	58	1.0	3NE1437-0		1	3 units	1DM
		800			5000000	58	1.0	3NE1438-0		1	3 units	1DM

Size	I_n	U_n	Operational class	Breaking value	Power loss	Varying load factor WL	SD	Article No. www.siemens.com/product?Article No.	Price per PU	PU (UNIT, SET, M)	PS	PG
	A	V AC/ V DC		A ² s	W		d					
LV HRC design												
With blade contacts for mounting in 3NH3 LV HRC fuse bases or switch disconnectors (see chapter "Switch Disconnectors", sections "Switch Disconnectors with Fuses" and "Fuse Switch Disconnectors")												
	000	6	690/	gR	37	2.7	On req.	3NE8810-OMK		1	3 units	1DM
		10	440		50	4.5	On req.	3NE8812-OMK		1	3 units	1DM
		16			73	6.7	On req.	3NE8813-OMK		1	3 units	1DM
		20			90	8	On req.	3NE8814-OMK		1	3 units	1DM
		25			150	8.1	On req.	3NE8815-OMK		1	3 units	1DM
		32			350	10.5	On req.	3NE8801-OMK		1	3 units	1DM
		40			480	12	On req.	3NE8802-OMK		1	3 units	1DM
		50			1050	14.5	On req.	3NE8817-OMK		1	3 units	1DM
		63			1960	23	On req.	3NE8818-OMK		1	3 units	1DM
		80		aR	2200	23.3	On req.	3NE8820-OMK		1	3 units	1DM
		100			3650	27	On req.	3NE8821-OMK		1	3 units	1DM
		125			7800	30	On req.	3NE8822-OMK		1	3 units	1DM
		160	500/ 440		14000	34	On req.	3NE8824-OMK		1	3 units	1DM
	With blade contacts for mounting in 3NH3 LV HRC fuse bases or switch disconnectors (see page 5/56)											
	00	25	690	gR	180	7	0.95	3NE8015-1		1	3 units	1DM
		35			400	9	0.95	3NE8003-1		1	3 units	1DM
		50			700	14	0.90	3NE8017-1		1	3 units	1DM
		63			1400	16	0.95	3NE8018-1		1	3 units	1DM
		80			5800	10.5	1.0	3NE1020-2		1	3 units	1DM
		100			11000	12	1.0	3NE1021-2		1	3 units	1DM
		125			23000	13.5	1.0	3NE1022-2		1	3 units	1DM
		80		aR	2400	19	0.95	3NE8020-1		1	3 units	1DM
		100			4200	22	0.95	3NE8021-1		1	3 units	1DM
		125			6500	28	0.95	3NE8022-1		1	3 units	1DM
	1	100	690/	aR	6050	25.5	On req.	3NE8221-OMK		1	3 units	1DM
		125	440		8900	28.5	On req.	3NE8222-OMK		1	3 units	1DM
		160			16200	37	On req.	3NE8224-OMK		1	3 units	1DM
		200			26000	49	On req.	3NE8225-OMK		1	3 units	1DM
		250			59000	52	On req.	3NE8227-OMK		1	3 units	1DM
		315			120000	68	On req.	3NE8230-OMK		1	3 units	1DM
		160	690	gR	18600	32	1.0	3NE1224-2		1	3 units	1DM
		200			51800	35	1.0	3NE1225-2		1	3 units	1DM
		250			80900	37	1.0	3NE1227-2		1	3 units	1DM
		315			168000	40	1.0	3NE1230-2		1	3 units	1DM
	2	350	690/	aR	83500	68.6	On req.	3NE8331-OMK		1	3 units	1DM
		400	440		136000	72.8	On req.	3NE8332-OMK		1	3 units	1DM
		450			207000	80.1	On req.	3NE8333-OMK		1	3 units	1DM
		500			318000	77.5	On req.	3NE8334-OMK		1	3 units	1DM
		550			399000	86.4	On req.	3NE8335-OMK		1	3 units	1DM
		630			740000	90.7	On req.	3NE8336-OMK		1	3 units	1DM
		350	690	gR	177000	43	1.0	3NE1331-2		1	3 units	1DM
		400			224000	50	1.0	3NE1332-2		1	3 units	1DM
		450			276500	58	1.0	3NE1333-2		1	3 units	1DM
		500			398000	64	1.0	3NE1334-2		1	3 units	1DM
	3	560	690	gR	890000	60	1.0	3NE1435-2		1	3 units	1DM
		630			1390000	60	1.0	3NE1436-2		1	3 units	1DM
		670			1640000	64	1.0	3NE1447-2		1	3 units	1DM
		710			1818000	72	1.0	3NE1437-2		1	3 units	1DM
		800			2475000	84	1.0	3NE1438-2		1	3 units	1DM
		850			3640000	76	1.0	3NE1448-2		1	3 units	1DM
	0	32	1000	gR	280	12	0.9	3NE4101		1	3 units	1DM
		40			500	13	0.9	3NE4102		1	3 units	1DM
		50			800	16	0.9	3NE4117		1	3 units	1DM
		63		aR	1500	20	0.9	3NE4118		1	3 units	1DM
		80			3000	22	0.9	3NE4120		1	3 units	1DM
		100			6000	24	0.9	3NE4121		1	3 units	1DM
		125			14000	30	0.9	3NE4122		1	3 units	1DM
		160			29000	35	0.9	3NE4124		1	3 units	1DM



Fuse Systems





SITOR Semiconductor Fuses

LV HRC design

Size	I_n	U_n	Operational class	Breaking I^2t value	Power loss	Varying load factor WL	SD	Article No. www.siemens.com/product?Article.No.	Price per PU	PU (UNIT, SET, M)	PS	PG
A		V AC/ V DC		A ² s	W		d					
LV HRC design												
With M8 bolt-on links, mounting dimension: 80 mm, for screwing onto busbars												
	000	20	690/	gR	83	7	0.9	3NE8714-1		1	10 units	1DM
		25	700 ¹⁾		140	9	0.9	3NE8715-1		1	10 units	1DM
		32			285	10	0.9	3NE8701-1		1	10 units	1DM
		40			490	12	0.9	3NE8702-1		1	10 units	1DM
		50		aR	815	15	0.9	3NE8717-1		1	10 units	1DM
		63			1550	16	0.95	3NE8718-1		1	10 units	1DM
		80			2700	18	0.9	3NE8720-1		1	10 units	1DM
		100			4950	19	0.95	3NE8721-1		1	10 units	1DM
		125			9100	23	0.95	3NE8722-1		1	10 units	1DM
		160			17000	31	0.9	3NE8724-1		1	10 units	1DM
		200			30000	36	0.9	3NE8725-1		1	10 units	1DM
		250			55000	42	0.9	3NE8727-1		1	10 units	1DM
	315			85500	54	0.85	3NE8731-1		1	10 units	1DM	
With M10 bolt-on links, mounting dimension: 80 mm, for screwing onto busbars or onto 3NH5323 fuse base												
	00	80	690/	gR	3200	23.0	On req.	3NE8020-3MK		1	3 units	1DM
		100	440		5200	29.0	On req.	3NE8021-3MK		1	3 units	1DM
		350		aR	135000	58.8	On req.	3NE8031-3MK		1	3 units	1DM
		400			170000	74.5	On req.	3NE8032-3MK		1	3 units	1DM

¹⁾ Observe DC voltage acc. to UL, time constant and minimum breaking current MBC (see "Technical specifications").

Size	I_n	U_n	Operational class	Breaking I^2t value	Power loss	Varying load factor WL	SD	Article No. www.siemens.com/product?Article.No.	Price per PU	PU (UNIT, SET, M)	PS	PG
A		V AC/ V DC		A ² s	W		d					
LV HRC design												
Parallel-connected fuses with slotted blade contacts for M12 screw fixing, mounting dimension: 110 mm (lateral 90 mm)												
	2 x 3	1000	690	gR	1400000	138	1.0	3NB3350-1KK26		1	1 unit	1DM
		1100			3000000	110		3NB3351-1KK26		1	1 unit	1DM
	2 x 3	1250			4100000	104	1.0	3NB3352-1KK26		1	1 unit	1DM
		1350			4800000	126		3NB3354-1KK26		1	1 unit	1DM
		1400			5200000	127		3NB3355-1KK26		1	1 unit	1DM
	2 x 3	1600			6900000	152	1.0	3NB3357-1KK26		1	1 unit	1DM
1700				10000000	143		3NB3358-1KK26		1	1 unit	1DM	
3 x 3	1700			6400000	179	1.0	3NB3358-1KK27		1	1 unit	1DM	
	1900			8200000	196		3NB3362-1KK27		1	1 unit	1DM	
With slotted blade contacts for M10 screw fixing, mounting dimension: 110 mm, or for installation in 3NH3 LV HRC fuse bases or switch disconnectors (see page 5/56)												
	2	250	800	aR	29700	105	0.85	3NE4327-0B		1	3 units	1DM
		315			60700	120	0.85	3NE4330-0B		1	3 units	1DM
		450			191000	140	0.85	3NE4333-0B		1	3 units	1DM
		500			276000	155	0.85	3NE4334-0B		1	3 units	1DM
		710			923000	155	0.95	3NE4337		1	3 units	1DM



Size	I_n	U_n	Operational class	Breaking value	Power loss	Varying load factor WL	SD	Article No. www.siemens.com/product?ArticleNo.	Price per PU	PU (UNIT, SET, M)	PS	PG	
A		V AC/ V DC		A ² s	W		d						
													
1	32 ¹⁾	1000/	gR		4500	9	On req.	3NE3201-OMK		1	3 units	1DM	
	40 ¹⁾				600	6000	13	On req.	3NE3202-OMK		1	3 units	1DM
	50 ¹⁾					8000	18	On req.	3NE3217-OMK		1	3 units	1DM
	63 ¹⁾					9000	25	On req.	3NE3218-OMK		1	3 units	1DM
	100	1000	aR		4800	28	0.95	3NE3221		1	3 units	1DM	
	125				7200	36	0.95	3NE3222		1	3 units	1DM	
	160				13000	42	1.0	3NE3224		1	3 units	1DM	
	200				30000	42	1.0	3NE3225		1	3 units	1DM	
	250				48000	50	1.0	3NE3227		1	3 units	1DM	
	315				80000	60	0.95	3NE3230-0B		1	3 units	1DM	
	350				100000	75	0.95	3NE3231		1	3 units	1DM	
	400	135000	85	0.9	3NE3232-0B		1	3 units	1DM				
	450	175000	95	0.9	3NE3233		1	3 units	1DM				
	500 ¹⁾	1000/ 600			500000	105	On req.	3NE3234-OMK08		1	3 units	1DM	
	550 ¹⁾				700000	110	On req.	3NE3235-OMK08		1	3 units	1DM	
	630 ¹⁾				850000	127	On req.	3NE3236-OMK08		1	3 units	1DM	
¹⁾ No grip lugs and therefore not suitable for mounting in 3NH3 LV HRC fuse bases or switch disconnectors (see page 5/56)													
2	400	1000	aR		135000	80	1.0	3NE3332-0B		1	3 units	1DM	
	450				175000	90	1.0	3NE3333		1	3 units	1DM	
	500				260000	90	1.0	3NE3334-0B		1	3 units	1DM	
	560				360000	95	1.0	3NE3335		1	3 units	1DM	
	630	600000	100	1.0	3NE3336		1	3 units	1DM				
	710	900	aR		800000	105	1.0	3NE3337-8		1	3 units	1DM	
	800				800	130	0.95	3NE3338-8		1	3 units	1DM	
	900				690	165	0.95	3NE3340-8		1	3 units	1DM	
													
													
3	100	1000	aR		13500	25	1.0	3NE3421-0C		1	3 units	1DM	
	224				54000	85	1.0	3NE3626-0C		1	3 units	1DM	
	315				218000	80	1.0	3NE3430-0C		1	3 units	1DM	
	400				364000	110	1.0	3NE3432-0C		1	3 units	1DM	
	450				488000	110	1.0	3NE3635-0C		1	3 units	1DM	
	500				870000	95	1.0	3NE3434-0C		1	3 units	1DM	
	630				1280000	132	1.0	3NE3636-0C		1	3 units	1DM	
	710				1950000	145	1.0	3NE3637-0C		1	3 units	1DM	
													
With slotted blade contacts for M12 screw fixing, mounting dimension: 140 mm													
3	710	1000	aR		1950000	145	1.0	3NE3637-1C		1	3 units	1DM	
With slotted blade contacts for M12 screw fixing, mounting dimension: 110 mm, or for installation in 3NH3 LV HRC fuse bases or switch disconnectors (see page 5/56)													
3	630	1000	aR		418000	145	0.85	3NC3336-1U		1	3 units	1DM	
	710				569000	150	0.85	3NC3337-1U		1	3 units	1DM	
	800				819000	155	0.85	3NC3338-1U		1	3 units	1DM	
	900				1160000	165	0.9	3NC3340-1U		1	3 units	1DM	
	1000				1670000	170	0.9	3NC3341-1U		1	3 units	1DM	
	1100				1910000	185	0.9	3NC3342-1U		1	3 units	1DM	
	1250				2600000	210	0.9	3NC3343-1U		1	3 units	1DM	
	3				315	1250	aR		72500	80	0.95	3NC3430-1U	
400	163000	95	0.95	3NC3432-1U					1	3 units	1DM		
500	290000	115	0.90	3NC3434-1U					1	3 units	1DM		
630	650000	120	0.95	3NC3436-1U					1	3 units	1DM		
800	985000	145	0.90	3NC3438-1U					1	3 units	1DM		

Fuse Systems

SITOR Semiconductor Fuses

LV HRC design







Size	I_n	U_n	Operational class	Breaking value	Power loss	Varying load factor WL	SD	Article No. www.siemens.com/product?Article No.	Price per PU	PU (UNIT, SET, M)	PS	PG
A		V AC/ V DC		A ² s	W		d					
LV HRC design												
With slotted blade contacts for M10 screw fixing, mounting dimension: 210 mm												
3	160	1500	aR	54000	56	1.0		3NE5424-0C		1	2 units	1DM
	224			138000	80	1.0		3NE5426-0C		1	2 units	1DM
	315			311000	115	1.0		3NE5430-0C		1	2 units	1DM
	350			428000	135	1.0		3NE5431-0C		1	2 units	1DM
	450			870000	145	0.95		3NE5433-0C		1	2 units	1DM
With slotted blade contacts for M12 screw fixing, mounting dimension: 210 mm												
	450	1500	aR	870000	145	0.95		3NE5433-1C		1	2 units	1DM
With slotted blade contacts for M10 screw fixing, mounting dimension: 170 mm												
3	250	1500	aR	84000	130	1.0		3NE5627-0C		1	3 units	1DM
	450			590000	160	1.0		3NE5633-0C		1	3 units	1DM
	600			1950000	145	1.0		3NE5643-0C		1	3 units	1DM
With slotted blade contacts for M10 screw fixing, 170 mm mounting dimension, for bolting onto busbars or onto 3NH5473 fuse base												
2	40	1500/	gR	900	26	On req.		3NE5302-0MK06		1	1 unit	1DM
	50	1000		1800	27	On req.		3NE5317-0MK06		1	1 unit	1DM
	63			3100	34	On req.		3NE5318-0MK06		1	1 unit	1DM
	80		aR	3900	42	On req.		3NE5320-0MK06		1	1 unit	1DM
	100			8700	45	On req.		3NE5321-0MK06		1	1 unit	1DM
	125			11800	59	On req.		3NE5322-0MK06		1	1 unit	1DM
	160			37000	54	On req.		3NE5324-0MK06		1	1 unit	1DM
	200			70000	56	On req.		3NE5325-0MK06		1	1 unit	1DM
	250			165000	59	On req.		3NE5327-0MK06		1	1 unit	1DM
	315			250000	76	On req.		3NE5330-0MK06		1	1 unit	1DM
	400	1500/		470000	89	On req.		3NE5332-0MK06		1	1 unit	1DM
	500	1000		800000	109	On req.		3NE5334-0MK06		1	1 unit	1DM
	630			1100000	163	On req.		3NE5336-0MK06		1	1 unit	1DM
2*	630	1500/ 1000	aR	1100000	163	On req.		3NE5336-0MK66		1	1 unit	1DM
* Special version with extended contacts, 190 mm mounting dimension, with fastening holes												
With slotted blade contacts for M10 screw fixing, mounting dimension: 210 mm												
3	200	2000	aR	138000	75	1.0		3NE7425-0U		1	2 units	1DM
	250			218000	110	1.0		3NE7427-0U		1	2 units	1DM
	350			555000	120	1.0		3NE7431-0U		1	2 units	1DM
	400			870000	150	1.0		3NE7432-0U		1	2 units	1DM
	450			960000	160	1.0		3NE7633-0U		1	2 units	1DM
	630			1950000	220	1.0		3NE7636-0U		1	2 units	1DM
With slotted blade contacts for M12 screw fixing, mounting dimension: 210 mm												
3	450	2000	aR	960000	160	1.0		3NE7633-1U		1	2 units	1DM
	525			1120000	210	1.0		3NE7648-1U		1	2 units	1DM
	630			1950000	220	1.0		3NE7636-1U		1	2 units	1DM
	710			3110000	275	1.0		3NE7637-1U		1	2 units	1DM
With slotted blade contacts for M12 screw fixing, mounting dimension: 260 mm												
3	125	2500	aR	34500	78	1.0		3NE9622-1C		1	1 unit	1DM
	400			620000	205	1.0		3NE9632-1C		1	1 unit	1DM
	500			1270000	235	1.0		3NE9634-1C		1	1 unit	1DM
	630			2800000	275	1.0		3NE9636-1C		1	1 unit	1DM
2	315	-/ 3000	aR	300000	245	On req.		3NE9330-0MK07		1	1 unit	1DM

Size	I_n	U_n	Operational class	Breaking I^2t value	Power loss	Varying load factor WL	SD	Article No. www.siemens.com/ product?Article No.	Price per PU	PU (UNIT, SET, M)	PS	PG
A	V	AC		A ² s	W		d					
LV HRC design												
With M12 female thread at both ends for direct busbar mounting, flange dimensions 52 mm												
	3	630	690	aR	244000	125	0.9	3NC3236-6U		1	3 units	1DM
		710			346000	130	0.9	3NC3237-6U		1	3 units	1DM
		800			498000	135	0.95	3NC3238-6U		1	3 units	1DM
		900			677000	140	0.95	3NC3240-6U		1	3 units	1DM
		1000			975000	145	1.0	3NC3241-6U		1	3 units	1DM
		1100			1382000	150	1.0	3NC3242-6U		1	3 units	1DM
		1250			1990000	155	1.0	3NC3243-6U		1	3 units	1DM
		1400	500		2100000	175	1.0	3NC3244-6U		1	3 units	1DM
		1600			2860000	195	0.95	3NC3245-6U		1	3 units	1DM
	With M10 female thread at both ends for direct busbar mounting, flange dimensions 109 mm											
	3	450	1000	aR	488000	110	1.0	3NE3635-6		1	3 units	1DM
With M12 female thread at both ends for direct busbar mounting, flange dimensions 73 mm												
	3	630	1000	aR	418000	130	0.90	3NC3336-6U		1	3 units	1DM
		710			569000	140	0.90	3NC3337-6U		1	3 units	1DM
		800			819000	150	0.90	3NC3338-6U		1	3 units	1DM
		900			1160000	160	0.95	3NC3340-6U		1	3 units	1DM
		1000			1670000	165	0.95	3NC3341-6U		1	3 units	1DM
		1100	800		1910000	175	0.95	3NC3342-6U		1	3 units	1DM
		1250			2600000	185	0.95	3NC3343-6U		1	3 units	1DM
	3	315	1250	aR	72500	80	0.95	3NC3430-6U		1	3 units	1DM
		400			163000	95	0.95	3NC3432-6U		1	3 units	1DM
		500			290000	115	0.90	3NC3434-6U		1	3 units	1DM
	630			650000	120	0.95	3NC3436-6U		1	3 units	1DM	
	800	1100		985000	145	0.95	3NC3438-6U		1	3 units	1DM	

Fuse Systems

SITOR Semiconductor Fuses

LV HRC design

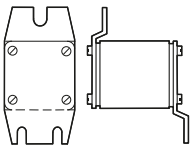
Size	I_n	U_n	Operational class	Breaking value	Power loss	Varying load factor WL	SD	Article No. www.siemens.com/product?Article No.	Price per PU	PU (UNIT, SET, M)	PS	PG
A		VAC		A ² s	W		d					
Fuses for special applications												
For screwing onto water-cooled busbars, for rectifiers in electrolysis systems												
	-- ¹⁾	350	800	aR	260000	80	0.9	3NC5531		1	3 units	1DM
		600	1000		888000	150	0.9	3NC5840		1	3 units	1DM
		630	800		888000	145	0.9	3NC5841		1	3 units	1DM
		800	1000		1728000	170	0.9	3NC5838		1	3 units	1DM
		710	900		620000	150	0.9	3NE6437-7		1	3 units	1DM
		1250	600		2480000	210	0.9	3NE9450-7		1	3 units	1DM
With M10 female thread at both ends for direct busbar mounting, flange dimensions 89 (99) ²⁾ mm, for air-cooled rectifiers in electrolysis systems												
	-- ¹⁾	710	900	aR	620000	150	0.9	3NE6437		1	3 units	1DM
		850	600	gR	2480000	85	1.0	3NE9440-6		1	3 units	1DM
		900	900	aR	1920000	170	0.9	3NE6444		1	3 units	1DM
		1250	600	aR	2480000	210	0.9	3NE9450		1	3 units	1DM
Fuses with installation holder for SITOR 6QG10 thyristor sets												
	-- ¹⁾	200	1000	aR	44000	50	0.85	3NE3525-5		1	2 units	1DM
		450			395000	90	0.85	3NE3535-5		1	2 units	1DM
Fuses with installation holder for SITOR 6QG11 thyristor sets												
	-- ¹⁾	50	1000	gR	1100	20	0.85	3NE4117-5		1	2 units	1DM
		100		aR	7400	35	0.85	3NE4121-5		1	2 units	1DM
		170		aR	60500	43	0.85	3NE4146-5		1	2 units	1DM
Fuses for special applications												
With female thread at both ends for SITOR 6QG12 thyristor sets, flange dimensions 77 mm												
	-- ¹⁾	250	800	aR	29700	105	0.85	3NE4327-6B		1	3 units	1DM
		315			60700	120	0.85	3NE4330-6B		1	3 units	1DM
		450			191000	140	0.85	3NE4333-6B		1	3 units	1DM
		500			276000	155	0.85	3NE4334-6B		1	3 units	1DM
		710			923000	155	0.95	3NE4337-6		1	3 units	1DM
Special design for mounting directly in the railway supply rectifier												
	-- ¹⁾	250	680	aR	635000	25	0.9	3NC7327-2		1	3 units	1DM
		350			1430000	32	0.9	3NC7331-2		1	3 units	1DM

¹⁾ Special design.

²⁾ Flange dimensions 99 mm only for 3NE6444.

Size	I_n	U_n	Operational class	Breaking I^2t value	P_v power loss	Varying load factor WL	SD	Article No. www.siemens.com/product?Article.No.	Price per PU	PU (UNIT, SET, M)	PS	PG
A	V DC			A ² s	W		d					
Fuses for special applications												
DC fuses with slotted blade contacts for M12 screw fixing												
2L	400	900	gR	240000 ¹⁾	75	--		3NB1234-3KK20		1	2 units	1DM
1L	200	1250	aR	39000 ²⁾	50	--		3NB1126-4KK11		1	2 units	1DM
	250			80500 ²⁾	51	--		3NB1128-4KK11		1	2 units	1DM
2L	315			129000 ²⁾	63	--		3NB1231-4KK11		1	2 units	1DM
	400			290000 ²⁾	68	--		3NB1234-4KK11		1	2 units	1DM
3L	500			600000 ²⁾	89	--		3NB1337-4KK11		1	2 units	1DM
	800			1910000 ²⁾	135	--		3NB1345-4KK11		1	2 units	1DM
Parallel-connected DC fuses with slotted blade contacts for M12 screw fixing												
2 x 3L	800	1250	aR	1150000 ²⁾	160	--		3NB2345-4KK16		1	1 unit	1DM
	1000			2250000 ²⁾	195	--		3NB2350-4KK16		1	1 unit	1DM
	1400			5100000 ²⁾	250	--		3NB2355-4KK16		1	1 unit	1DM
	1600			7450000 ²⁾	275	--		3NB2357-4KK16		1	1 unit	1DM
3 x 3L	2100			1195000 ²⁾	365	--		3NB2364-4KK17		1	1 unit	1DM
	2400			18100000 ²⁾	445	--		3NB2366-4KK17		1	1 unit	1DM



1) I^2t at U_{VSI} 1400 V, I^2t at U_n 900 V is 180000 A²s

2) I^2t at U_{VSI} 1500 V, I^2t at U_n 1250 V is reduced with factor $k = 0.79$

Note:

VSI is the abbreviation for Voltage Sourced Inverter. The VSI voltage U_{VSI} is a DC test voltage defined in IEC 60269-4 specially for use in applications with energy stores. The extremely steep current rise in the event of a fault is characteristic of such applications.

For SITOR 3NB1 and 3NB2 semiconductor fuses, the VSI voltage and the applicable I^2t value are specified in the "Technical specifications" table; for all other SITOR semiconductor fuses, these values are available on request.

Version	For fuse series	I_n	U_n	Connection bolt	SD	Article No. www.siemens.com/product?Article.No.	Price per PU	PU (UNIT, SET, M)	PS	PG
mm		A	V AC/ V DC		d					
Fuse bases for SITOR fuses										
<ul style="list-style-type: none"> • With bolt-on links or slotted blade contacts • 1-pole 										
75	3NC18	50	690	M5		3NH5723		1	3 units	1BM
80	3NE87, 3NC26	315	690	M8		3NH5023		1	3 units	1BM
	3NE80...-3MK	400	690	M10		3NH5323		1	3 units	1BM
	3NC32...-1U, 3NE82...-3MK	1600	690	M10		3NH5423		1	3 units	1BM
	3NC24, 3NC33...-1U, 3NC34...-1U, 3NC84, 3NE1...-3, 3NE32, 3NE33, 3NE34	1250	1250	M10		3NH5463		1	3 units	1BM
170	3NE53, 3NE56	630	1800	M10		3NH5473		1	3 units	1BM



Fuse Systems

SITOR Semiconductor Fuses

Cylindrical fuse design

Overview

SITOR cylindrical fuses protect power semiconductors from the effects of short circuits because the super quick-response disconnect characteristic is far quicker than that of conventional fuses. They protect high-quality devices and system components such as semiconductor contactors, electronic relays (solid state), converters with fuses in the input and in the DC link, UPS systems and soft starters for motors up to 100 A.

The cylindrical design is approved for industrial applications. The cylindrical fuse links comply with IEC 60269.

Cylindrical fuse holders also comply with IEC 60269 and UL 512. The cylindrical fuse holders for 10 × 38 mm and 14 × 51 mm have been tested and approved as fuse switch disconnectors and the cylindrical fuse holders for 22 × 58 mm as fuse disconnectors according to the switching device standard IEC 60947-3. The utilization category and the tested current and voltage values are specified in the Table "Technical specifications".

The cylindrical fuse holders have been specially developed for the application of SITOR fuse links with regard to heat tolerance and heat dissipation and are therefore not recommended for standard applications.

Cylindrical fuse bases do not offer the same comprehensive touch protection as the fuse holders, but have better heat dissipation. The single-pole cylindrical fuse bases for 14 × 51 mm and 22 × 58 mm allow modular expansion to multi-pole bases.

Benefits



- Cylindrical fuses have an extremely compact design and a correspondingly small footprint
- The cylindrical fuses have IEC and UL approval and are suitable for universal use worldwide
- The use of SITOR cylindrical fuses in the cylindrical fuse holders and bases has been tested with regard to heat dissipation and maximum current loading. This makes planning and dimensioning easier and prevents consequential damage
- The use of fuse holders as switch disconnectors expands the area of application of these devices and increases operating safety

Technical specifications

		Cylindrical fuse holders		
		3NC10	3NC14	3NC22
Size	mm x mm	10 x 38	14 x 51	22 x 58
Standards		UL 4248-1; CSA C22.2; IEC 60269-2, IEC 60947-3		
Certifications		UL, CCC, CE	UL, CCC, CE	UL, CE
Approvals		UL 4248-1; UL File No. E171267; CSA C22.2 No. 39-M		
Rated voltage U_n	V AC V DC	690; 600 acc. to UL/CSA 800		
Rated current I_n	A AC	32 30 acc. to UL/CSA	50 50 acc. to UL 40 acc. to CSA	100 80 acc. to UL/CSA
Rated conditional short-circuit current	kA	50	50 (100 at 400 V)	50 (100 at 500 V)
Breaking capacity • Utilization category		AC-22B (400 V)	AC-22B (400 V)	AC-20B (690 V)
Max. power dissipation of fuse links (conductor cross-section used)	W	3 (6 mm ²) 4.3 (10 mm ²)	5 (10 mm ²) 6.5 (25 mm ²)	9.5 (35 mm ²) 11 (50 mm ²)
Rated impulse withstand voltage	kV	6		
Overvoltage category		II		
Pollution degree		2		
No-voltage changing of fuse links		Yes		
Sealable when installed		Yes		
Mounting position		Any		
Current direction		Any		
Degree of protection acc. to IEC 60529		IP20, with connected conductors ¹⁾		
Terminals with touch protection according to BGV A3 at incoming and outgoing feeder		Yes		
Ambient temperature	°C	45		
Conductor cross-sections • Finely stranded, with end sleeve • AWG (American Wire Gauge)	mm ² AWG	1.5 ... 16 15 ... 5	1.5 ... 35 14 ... 2	4 ... 50 10 ... 1/0
Tightening torque	Nm lbs/in.	2.5 22	2.5 ... 3 22 ... 26	3.5 ... 4 31 ... 35

¹⁾ Degree of protection IP20 is tested according to regulations using a straight test finger (from the front), with the device mounted and equipped with a cover, housing or some other enclosure.

Selection and ordering data

	Size	I_n	U_n	Breaking I^2t value	P_V power loss	SD	Article No. www.siemens.com/product?Article No.	Price per PU	PU (UNIT, SET, M)	PS	PG				
	mm × mm	A	V AC/ V DC	A ² s	W	d									
Cylindrical fuse links, operational class gR															
	10 × 38	6	690/440	6.5	2.5		3NC1006-OMK		1	20 units	1DM				
		10		18	3.3		3NC1010-OMK		1	20 units	1DM				
		12		35	4		3NC1012-OMK		1	20 units	1DM				
		16		45	6		3NC1016-OMK		1	20 units	1DM				
		20		690/250	110		7.8		3NC1020-OMK	1	20 units	1DM			
		25			140		8.7		3NC1025-OMK	1	20 units	1DM			
	32	450	12		3NC1032-OMK	1	20 units	1DM							
	14 × 51	6	690/700	3.5	3.1		3NC1406-OMK		1	10 units	1DM				
		10	690/600	15	4.6		3NC1410-OMK		1	10 units	1DM				
		16		32	6.7		3NC1416-OMK		1	10 units	1DM				
		20	690/440	68	7.4		3NC1420-OMK		1	10 units	1DM				
		25		108	8.4		3NC1425-OMK		1	10 units	1DM				
		32		175	12.3		3NC1432-OMK		1	10 units	1DM				
		40		470	11.7		3NC1440-OMK		1	10 units	1DM				
		50		690/250	830		16.3		3NC1450-OMK	1	10 units	1DM			
		22 × 58		25	690/700		180		8.1		3NC2225-OMK		1	10 units	1DM
			32	690/600	420		9		3NC2232-OMK		1		10 units	1DM	
	40		690/440	700	12.5	3NC2240-OMK	1	10 units	1DM						
50	690/250		1250	15.2	3NC2250-OMK	1	10 units	1DM							
63			2400	17.5	3NC2263-OMK	1	10 units	1DM							
80			4400	23	3NC2280-OMK	1	10 units	1DM							
100	11500		28.7	3NC2200-OMK	1	10 units	1DM								
Cylindrical fuse links, operational class aR															
	10 × 38 ²⁾	3	600/700 ¹⁾	8	1.2		3NC1003		1	10 units	1DM				
		6		20	1.5		3NC1006		1	10 units	1DM				
		8		30	2		3NC1008		1	10 units	1DM				
		10		60	2.5		3NC1010		1	10 units	1DM				
		12		110	3		3NC1012		1	10 units	1DM				
		16		150	3.5		3NC1016		1	10 units	1DM				
		20		200	4.8		3NC1020		1	10 units	1DM				
		25		250	6		3NC1025		1	10 units	1DM				
		32		600/--	500		7.5		3NC1032	1	10 units	1DM			
		14 × 51		1	660/--		1.2		5		3NC1401		1	10 units	1DM
				2			10		3		3NC1402		1	10 units	1DM
				3			15		2.5		3NC1403		1	10 units	1DM
	4		25	3		3NC1404	1	10 units	1DM						
	5		690/700 ¹⁾	11		1.5	3NC1405	1	10 units		1DM				
	6			11		1.5	3NC1406	1	10 units		1DM				
	10		690/250	22		4	3NC1410	1	10 units		1DM				
	15			70		5.5	3NC1415	1	10 units		1DM				
	20			100		6	3NC1420	1	10 units		1DM				
	25			320		7	3NC1425	1	10 units		1DM				
	30			400		9	3NC1430	1	10 units		1DM				
	32			600		7.6	3NC1432	1	10 units		1DM				
	40	750	8	3NC1440	1	10 units	1DM								
	50	1800	9	3NC1450	1	10 units	1DM								
	63	2100	16.7	3NC1463-OMK	1	10 units	1DM								
22 × 58	20	690/700 ¹⁾	220	4.6		3NC2220		1	5 units	1DM					
	25		300	5.6		3NC2225		1	5 units	1DM					
	32		450	7		3NC2232		1	5 units	1DM					
	40		700	8.5		3NC2240		1	5 units	1DM					
	50		1350	9.5		3NC2250		1	5 units	1DM					
	63		2600	11		3NC2263		1	5 units	1DM					
	80		5500	13.5		3NC2280		1	5 units	1DM					
	100		8000	16		3NC2200		1	5 units	1DM					
	125		690/250	29000		35.3		3NC2211-OMK	1	10 units	1DM				





¹⁾ Observe DC voltage acc. to UL, time constants and minimum breaking current MBC (see "Technical specifications").

²⁾ CCC approval





Fuse Systems

SITOR Semiconductor Fuses

Cylindrical fuse design

Size	I_n	U_n	Breaking value	I^2t	P_V power loss	SD	Article No. www.siemens.com/ product?ArticleNo.	Price per PU	PU (UNIT, SET, M)	PS	PG
mm × mm	A	V AC/ V DC	A ² s	W	d						
Cylindrical fuse links with striking pin, operational class aR											
	14 × 51	10	690/600 ¹⁾	32	4		3NC1410-5		1	10 units	1DM
		15		63	5.5		3NC1415-5		1	10 units	1DM
		20		234	6		3NC1420-5		1	10 units	1DM
		25		378	7		3NC1425-5		1	10 units	1DM
		30		466	9		3NC1430-5		1	10 units	1DM
		32		600	7.6		3NC1432-5		1	10 units	1DM
		40		750	8		3NC1440-5		1	10 units	1DM
		50		1800	9		3NC1450-5		1	10 units	1DM
	22 × 58	20	690/500 ¹⁾	240	5		3NC2220-5		1	5 units	1DM
		25		350	6		3NC2225-5		1	5 units	1DM
	32		500	8		3NC2232-5		1	5 units	1DM	
	40		800	9		3NC2240-5		1	5 units	1DM	
	50		1500	9.5		3NC2250-5		1	5 units	1DM	
	63		3000	11		3NC2263-5		1	5 units	1DM	
	80		6000	13.5		3NC2280-5		1	5 units	1DM	
22 × 58	100	600/500 ¹⁾	8500	16		3NC2200-5		1	5 units	1DM	
Cylindrical fuse links											
Operational class gS											
	22 × 127	1	1500/	2	2		3NC2301-OMK		1	5 units	1DM
		2	1000	4.4	2.5		3NC2302-OMK		1	5 units	1DM
		4		55	5.3		3NC2304-OMK		1	5 units	1DM
		6		150	6.4		3NC2306-OMK		1	5 units	1DM
		10		540	3.1		3NC2310-OMK		1	5 units	1DM
		16		1120	4.7		3NC2316-OMK		1	5 units	1DM
		20		2850	5.4		3NC2320-OMK		1	5 units	1DM
		25		3300	6.9		3NC2325-OMK		1	5 units	1DM
	32		9050	6.7		3NC2332-OMK		1	5 units	1DM	
Operational class gR											
22 × 127	40	1500/ 1000	18500	9.4		3NC2340-OMK		1	5 units	1DM	
Operational class aR											
22 × 127	50	1500/ 1000	26000	11.6		3NC2350-OMK		1	5 units	1DM	
Cylindrical fuse links, with M8 bolt-on links											
With bolt-on links: Mounting dimension 75 mm, for screwing onto busbars or onto 5SH5723 fuse base											
Operational class gR											
	18 × 88	10	690/ 440	17	4.3		3NC1810-OMK		1	3 units	1DM
		16		52	4.4		3NC1816-OMK		1	3 units	1DM
		20		90	6.5		3NC1820-OMK		1	3 units	1DM
		25		160	8.5		3NC1825-OMK		1	3 units	1DM
		32		400	8.9		3NC1832-OMK		1	3 units	1DM
		40		600	11		3NC1840-OMK		1	3 units	1DM
		50		1250	13.8		3NC1850-OMK		1	3 units	1DM
With bolt-on links: Mounting dimension 80 mm, for screwing onto busbars or onto 5SH5023 fuse base											
Operational class gR											
	26 × 103	25	690/ 440	120	9.5		3NC2625-OMK		1	3 units	1DM
		32		220	12.3		3NC2632-OMK		1	3 units	1DM
		40		400	14.8		3NC2640-OMK		1	3 units	1DM
		50		980	17.5		3NC2650-OMK		1	3 units	1DM
		63		2050	18.8		3NC2663-OMK		1	3 units	1DM
Operational class aR											
	80		3500	22.5		3NC2680-OMK		1	3 units	1DM	
	100		5400	31.5		3NC2600-OMK		1	3 units	1DM	
	125		11800	39		3NC2611-OMK		1	3 units	1DM	

1) DC voltage acc. to UL.

Version	For fuse series	I_n	U_n	Connection bolt	SD	Article No. www.siemens.com/ product?Article No.	Price per PU	PU (UNIT, SET, M)	PS	PG
mm		A	V DC		d					
 Fuse bases for SITOR fuses With bolt-on links or slotted blade contacts, 1-pole										
75	3NC18	50	690	M5		3NH5723		1	3 units	1BM
80	3NE87, 3NC26	315	690	M8		3NH5023		1	3 units	1BM
Size	Version	Rated voltage		SD	Article No. www.siemens.com/ product?Article No.	Price per PU	PU (UNIT, SET, M)	PS	PG	
mm × mm		V AC/V DC		d						
 Cylindrical fuse holders Can be used as fuse switch disconnectors ¹⁾										
10 × 38	1P 2P 3P	690/800			3NC1091 3NC1092 3NC1093		1	12 units	1DM	
14 × 51	1P 2P 3P				3NC1491 3NC1492 3NC1493		1	6 units	1DM	
22 × 58	1P 2P 3P				3NC2291 3NC2292 3NC2293		1	1 unit	1DM	
22 × 127	1P 2P 3P	1500/1000			3NC2391-OMK 3NC2392-OMK 3NC2393-OMK		1	4 units	1DM	
 Cylindrical fuse holders Can be used as fuse switch disconnectors ¹⁾ With signaling switches for fuse links with striking pin ²⁾										
14 × 51	1P	690/800			3NC1491-5		1	6 units	1DM	
22 × 58	1P				3NC2291-5		1	6 units	1DM	
 Cylindrical fuse bases										
10 × 38	1P 2P 3P	600/--			3NC1038-1 3NC1038-2 3NC1038-3		1	10 units	1DM	
 Fuse tongs										
10 × 38, 14 × 51, 22 × 58					3NC1000		1	1 unit	1DM	

¹⁾ Please note the utilization category and current/voltage values; see "Technical specifications", page 5/70.

²⁾ Microswitch 5 A, 250 V AC

Fuse Systems

SITOR Semiconductor Fuses

NEOZED, DIAZED design

Overview

SILIZED is the brand name for NEOZED fuses (D0 fuses) and DIAZED fuses (D fuses) with super-quick-acting characteristic for semiconductor protection.

The fuses are used in combination with fuse bases, fuse screw caps and accessory parts of the standard fuse system.

SILIZED semiconductor fuses protect power semiconductors from the effects of short circuits because the super-quick-acting characteristic is far quicker than that of conventional fuses. They protect high-quality devices and system components, such as semiconductor contactors, static relays, converters with fuses in the input and in the DC link, UPS systems and soft starters for motors up to 100 A.

When using fuse bases and fuse screw caps made of molded plastic, always heed the maximum permissible power loss values due to the high power loss (power dissipation) of the SILIZED fuses.

When using these components, the following maximum permissible power loss applies:

- NEOZED D02: 5.5 W
- DIAZED DII: 4.5 W
- DIAZED DIII: 7.0 W

This enables a partial thermal permanent load of only 50%.

The DIAZED screw adapter DII for 25 A is used for the 30 A fuse link.

Benefits

- SILIZED semiconductor fuses have an extremely compact design. This means they have a very small footprint – particularly the NEOZED version
- The rugged and well-known DIAZED design complies with IEC 60269-3. It is globally renowned and can be used in many countries
- A wide range of fuse bases and accessories is available for the NEOZED and DIAZED versions of the SILIZED semiconductor fuses. This increases the application options in many devices

5

Technical specifications

		5SE13 NEOZED design fuse links	5SD4 DIAZED design fuse links
Standards		DIN VDE 0636-3; IEC 60269-3; EN 60269-4 (VDE 0636-4); IEC 60269-4	
Operational class		gR	
Characteristic		Super-quick-acting	
Rated voltage U_n	V AC	400	500
	V DC	250	500
Rated current I_n	A	10 ... 63	16 ... 100
Rated breaking capacity	kA AC	50	
	kA DC	8	
Mounting position		Any, preferably vertical	
Non-interchangeability		Using adapter sleeves	Using screw adapter or adapter sleeves
Resistance to climate	°C	Up to 45 at 95% rel. humidity	
Ambient temperature	°C	-5 ... +40 °C, humidity 90% at 20 °C	

Selection and ordering data

Size	I_e A	U_e V AC/ V DC	Breaking I^2t value A ² s	Power loss W	SD d	Article No. www.siemens.com/ product?Article No.	Price per PU	PU (UNIT, SET, M)	PS	PG
SILIZED fuse links, operational class gR										
D01	10	400/250	73	6.9		5SE1310		1	10 units	1DM
	16		120	6.2				1	10 units	1DM
D02	20		190	8.1		5SE1320		1	10 units	1DM
	25		215	8.2				1	10 units	1DM
	35		470	16.7				1	10 units	1DM
	50		1960	12.0				1	10 units	1DM
	63		4230	15.5				1	10 units	1DM
DII	16	500/500	60	12.1		5SD420		1	5 units	1DM
	20		139	12.3				1	5 units	1DM
	25		205	12.5				1	5 units	1DM
	30		310	13.5				1	5 units	1DM
DIII	35		539	14.8		5SD450		1	5 units	1DM
	50		1250	18.5				1	5 units	1DM
	63		1890	28				1	5 units	1DM
DIV	80		4200	34.3		5SD510		1	3 units	1DM
	100		8450	41.5				1	3 units	1DM



Fuse Systems

Photovoltaic Fuses

Introduction

Overview

Special demands are made on fuses for application in photovoltaic systems. These fuses have a high DC rated voltage and a tripping characteristic specially designed to protect PV modules and their connecting cables (the newly defined operational class gPV). It is also crucial that the PV fuses do not age in spite of strongly alternating load currents, in order to ensure high plant availability throughout the service life of the PV system. The fuses must also be able to withstand high temperature fluctuations without damage. These requirements were only incorporated into an international standard in recent years and have now been published as IEC 60269-6.

The latest standardization effort was published as a draft standard in 2017 and is expected to be available in the form of Amendment A1 to IEC 60269-6 in the middle of 2018; several months later than EN. It should be noted that renewed changes in low and high test currents, as well as in conventional times, i.e. current-time characteristic curves, have been incorporated into this latest version. A distinction is now made between fuses for the protection of the strings and fuses for the protection of the array or subarray. This satisfies the different requirements in the PV panel (protection against reverse currents) and in the area downstream (viewed from the infeed direction) of the generator terminal boxes (essentially short-circuit protection).

The PV cylindrical fuses of size 10 mm x 38 mm offer an especially space-saving solution for the protection of the strings.

The fuse holders of size 10 x 38 mm can be supplied in single-pole and two-pole versions with and without signal detectors. In the case of devices with signal detector, a small electronic device with LED is located behind an inspection window in the plug-in module. If the inserted fuse link is tripped, this is indicated by the LED flashing. The devices have a sliding catch that enables removal of individual devices from the assembly. The infeed can be from the top or the bottom. Because the cylindrical fuse holders are fitted with the same anti-slip terminals at the top and the bottom, the devices can also be bus-mounted at the top or the bottom.

The PV fuses in LV HRC design are usually used as cumulative fuses upstream of the inverter. In addition, they can also be used for protecting groups (PV subarrays). For the PV cumulative fuses of size 1, the standard LV HRC fuse bases are available. For PV cumulative fuses of size 1L, 1XL, 2L, 2XL and 3L, we have developed a special 3NH7...-4 fuse base with a swiveling mechanism which combines maximum touch protection with maximum user-friendliness. This makes it possible to change fuses safely and without the need for any tools, such as a fuse handle. This provides safe and fast access even in an emergency.

Our cylindrical fuse holders and fuse bases with swiveling mechanism comply with the IEC 60269-2 standard and are considered as fuse disconnectors as defined in the IEC 60947 switchgear and controlgear standard. Under no circumstances are they suitable for switching loads.

To ensure that PV fuses are correctly selected and dimensioned, the specific operating conditions and the PV module data must be taken into account when calculating voltage and current ratings.

Benefits

- Protection of the modules and their connecting cables in the event of reverse currents
- Safe tripping in case of fault currents reduces the risk of fire due to DC electric arcs
- Safe separation when the fuse holder/fuse base is open



PV cylindrical fuse system, 3NH70..-4, 3NH60..-4



PV LV HRC fuse systems, 3NH73..-4, 3NE13..-4D

Technical specifications

	Cylindrical fuse links		Cylindrical fuse holders	
	3NW60...-4	3NW66...-4	3NW70...-4	3NW76...-4
Size	mm x mm	10 x 38	10 x 85	
Standards		IEC 60269-6	IEC 60269, IEC 60269-2, IEC 60947, UL 4248-1, -18	IEC 60269, IEC 60269-2, IEC 60947, UL 4248-1, -18
Approvals		UL 248-13, waiver certification for China (2 to 16 A)	UL (File No. E469670)	UL (File No. E355487), UL (E355487)
Operational class		gPV		
Rated voltage U_n	V DC	1000	1500 (20 A: 1200 V)	1000 1500
Rated current I_n	A DC	2 to 20	4 to 20	30 32
Rated short-circuit strength	kA	--		30
Rated breaking capacity	kA DC	30	10	--
Breaking capacity • Utilization category		--		AC-20B, DC-20B
Max. power dissipation of the fuse link	W	--		4 6
Rated impulse withstand voltage	kV	--		6 --
Overvoltage category		--		II --
Pollution degree		--		2 --
No-voltage changing of fuse links		--		Yes
Sealable when installed		--		Yes
Mounting position		Any, preferably vertical		
Current direction		--		Any (signal detector with antiparallel LED)
Degree of protection acc. to IEC 60529		--		IP20, with connected conductors ¹⁾
Terminals with touch protection according to BGV A3 at incoming and outgoing feeder		--		Yes
Ambient temperature	°C	-25 ... +55 °C, humidity 90% at +20 °C		
Conductor cross-sections • Finely stranded, with end sleeve • AWG (American Wire Gauge)	mm ² AWG	--		0.75 ... 25 18 ... 4
Tightening torque	Nm	--		2.5

¹⁾ Degree of protection IP20 is tested according to regulations using a straight test finger (from the front), with the device mounted and equipped with a cover, housing or some other enclosure.

Selection and ordering data

	Size	I_n	U_n	P_v	$P_{v \text{ at } 70\%}^{1)}$	SD	Article No. www.siemens.com/ product?Article.No.	Price per PU	PU (UNIT, SET, M)	PS	PG	
	mm x mm	A DC	V DC	W	W	d						
 3NW6004-4	Cylindrical fuse links, operational class gPV											
	10 x 38	2	1000	1.4	0.6	▶	3NW6002-4			1	20 units	1DN
		4		1.6	0.7		3NW6004-4					
		6		1.7	0.7		3NW6001-4					
		8		1.9	0.8		3NW6008-4					
		10		2.3	1.0		3NW6003-4					
		12		2.7	1.1		3NW6006-4					
		16		3.2	1.3		3NW6005-4					
	20		3.4	1.4		3NW6007-4						
	10 x 85	4	1500	2.7	1.1		3NW6604-4			1	10 units	1DN
6			3.0	1.2		3NW6601-4						
8			3.6	1.5		3NW6608-4						
10			3.7	1.6		3NW6603-4						
12			3.3	1.4		3NW6606-4						
16			3.7	1.6		3NW6605-4						
20		1200	4.0	1.7		3NW6607-4						



3NW6604-4

¹⁾ Tested in the fuse holder 3NW7013-4 or 3NW7613-4.

Fuse Systems

Photovoltaic Fuses

PV cylindrical fuses

	Number of poles	I_n	For fuse links of size	Width	SD	Article No. www.siemens.com/ product?Article No.	Price per PU	PU (UNIT, SET, M)	PS	PG
		A DC	mm x mm	MW	d					
 3NW7014-4	Cylindrical fuse holders, 1000 V with signal detector									
	1P	30	10 x 38	1		3NW7014-4		1	12 units	1DN
	2P	30	10 x 38	2		3NW7024-4		1	6 units	1DN
	Without signal detector									
	1P	30	10 x 38	1		3NW7013-4		1	12 units	1DN
	2P	30	10 x 38	2		3NW7023-4		1	6 units	1DN
 3NW7613-4	Cylindrical fuse holders, 1500 V									
	1P	32	10 x 85	1.3		3NW7613-4		1	5 units	1DN

5

Technical specifications

	Fuse links						Fuse bases						
	3NE1...-4 / -4D / -4E / -5E						3NH7...-4						
Size	1	1L	2L	3L	1XL	2XL	1	1L	2L	3L	1XL	2XL	
Standards	IEC 60269-6						IEC 60269, IEC 60269-2, IEC 60947						
Operational class	gPV												
Rated voltage U_n	V DC	1000 at time constant (L/R) 3 ms 1500 at time constant (L/R) 3 ms					1000			1500			
Rated current I_n	A DC	63 ... 160	200/250	315/400	500/630	63 ... 200	250/315	160	250	400	630	250	400
Rated short-circuit strength	kA	--					30						
Rated breaking capacity	kA DC	30					--						
Breaking capacity		--						AC-20B, DC-20B (switching without load)					
• Utilization category		--						AC-20B, DC-20B (switching without load)					
Max. power dissipation of the fuse link	W	--					40	90	110	130	90	110	
No-voltage changing of fuse links		--						Yes					
Sealable when installed		--						Yes					
Mounting position		Any, preferably vertical											
Current direction		--						Any					
Ambient temperature	°C	-25 ... +55 °C, humidity 90% at +20 °C											
Tightening torque	Nm	--						20					
Microswitch for tripped signaling 5 A/250 V AC, 0.2 A/250 V DC		In the "fuse not blown" state, contacts 1 and 3 are closed.											



Selection and ordering data

	Size	I_n	U_n	P_v at U_n	SD	Article No. www.siemens.com/ product?Article.No.	Price per PU	PU (UNIT, SET, M)	PS	PG		
		A DC	V DC	W	d							
 3NE1330-4D	Fuse links operational class gPV											
	1	63	1000	19	3NE1218-4				1	2 units	1DN	
		80		20								3NE1220-4
		100		24								3NE1221-4
		125		26								3NE1222-4
		160		32								3NE1224-4
		200		51								3NE1225-4D
	1L	250	54	3NE1227-4D								
		315	73	3NE1330-4D								
	2L	400	82	3NE1332-4D								
		500	100	3NE1434-4E								
	3L	630	110	3NE1436-4E								
		63	1500	20	3NE1218-5E				1	2 units	1DN	
	1XL	80		25	3NE1220-5E							
		100		30	3NE1221-5E							
		125		29	3NE1222-5E							
		160		34	3NE1224-5E							
		200		41	3NE1225-5E							
2XL		250	53	3NE1327-5E								
	315	63	3NE1330-5E									

Fuse Systems

Photovoltaic Fuses

PV cumulative fuses

	For fuse links of size	I_n	U_n	SD	Article No. www.siemens.com/ product?Article No.	Price per PU	PU (UNIT, SET, M)	PS	PG
	A DC			d					
Fuse bases with flat terminal									
Standard ceramic fuse base									
	1	250	1000		3NH3230		1	3 units	1BM
Fuse bases with swiveling mechanism									
	1L	250	1000		3NH7260-4		1	1 unit	1DN
	2L	400	1000		3NH7360-4		1	1 unit	1DN
	3L	630	1000/1500		3NH7460-4		1	1 unit	1DN
	1XL	250	1500		3NH7261-4		1	1 unit	1DN
	2XL	400	1500		3NH7361-4		1	1 unit	1DN
Fuse bases with swiveling mechanism and microswitch for tripped signaling of the fuse¹⁾									
	1	250	1000		3NH7262-4KK01		1	1 unit	1DN
	2L	400	1000		3NH7360-4KK01		1	1 unit	1DN
Accessories									
Terminal covers for PV fuse bases with swiveling mechanism									
	1, 1L, 1XL				3NX3121		1	1 unit	1DN
	2L, 2XL				3NX3122		1	1 unit	1DN
	3L				3NX3123		1	1 unit	1DN

¹⁾ Fuse must be inserted upside down.

1. General standards

By using this catalog you can acquire hardware and software products described therein from Siemens AG subject to these conditions of sale and delivery (hereinafter: CSD). Please note: the scope, the quality and the conditions for supplies and services, including software products, by any Siemens group or Regional Company having a registered office outside of Germany, shall be subject exclusively to the General Terms and Conditions of the respective Siemens entity. These CSD apply exclusively for orders placed with Siemens AG, Germany.

1.1 For customers with a seat or registered office in Germany

For customers with a seat or registered office in Germany, the following shall be subordinate to these CSD

- for installation, the "Standard Terms and Conditions for Installation –Germany" and
- for Plant Analytics Services the "Standard Terms and Conditions for Plant Analytics Services – for Customers in Germany"¹⁾ and
- for standalone software products and software products that are part of another product or project, the "General License Conditions for Software Products for Automation and Drives for Customers with a Seat or Registered Office in Germany"¹⁾ and
- for other supplies and services, the "General Conditions for the Supply of Products and Services of the Electrical and Electronics Industry"¹⁾.
In the event that such other supplies and services include open-source software, the conditions of which override the "General Conditions for the Supply of Products and Services of the Electrical and Electronics Industry"¹⁾, the product will be supplied with a notice detailing the special conditions that apply for the relevant open-source software. This applies accordingly in the case of a reference to other third-party software components.

1.2 For customers with a seat or registered office outside of Germany

For customers with a seat or registered office outside of Germany, the following shall be subordinate to these CSD

- for Plant Analytics Services the "Standard Terms and Conditions for Plant Analytics Services"¹⁾ (only available in English) and
- for services, the "International Terms & Conditions for Services"¹⁾ supplemented by the "Software Licensing Conditions"¹⁾ and
- for the supply of other hardware and software the "International Terms & Conditions for Products"¹⁾ supplemented by the "Software Licensing Conditions"¹⁾.

1.3 For customers with framework agreements

To the extent that our products and services are covered by an existing framework agreement, the conditions there apply instead of this CSD.

2. Prices

The prices are in € (euros) ex works, excluding packaging.

The sales tax (value added tax) is not included in the prices. It shall be debited separately at the respective rate according to the applicable legal regulations.

Prices are subject to change without prior notice. We will debit the prices valid at the time of delivery.

To compensate fluctuating prices of raw materials (for example silver, copper, aluminum, lead, gold, dysprosium and neodymium), surcharges are calculated on a daily basis for products containing these raw materials using the metal factor. A surcharge for the particular raw material is added to the price of a product if the basic quotations for this raw material are exceeded.

Each product's metal factor dictates for which raw materials the metal surcharges are calculated, from which quotation and with which calculation method (weight or percentage method).

An exact explanation of the metal factor can be found at: www.siemens.com/automation/salesmaterial-as/catalog/en/terms_of_trade_en.pdf

The surcharge will be calculated (except in the case of dysprosium and neodymium) on the basis of the official price on the day prior to receipt of the order or prior to the release order for calculation of the surcharge.

In the event of placement of an order, the relevant three-month average price from the quarter prior to order receipt or the release order shall be used with a one-month buffer to calculate the dysprosium and neodymium surcharge ("rare earths") (you will find details in the aforementioned explanation of the metal factor).

3. Additional terms and conditions

All dimensions are in mm. In Germany, according to the German law on units in metrology, data in inches only apply to devices for export.

Illustrations are not binding.

Insofar as there are no remarks on the corresponding pages of this catalog - especially with regard to data, dimensions and weights given - these are subject to change without prior notice.

¹⁾ You can download the text of the Siemens AG terms and conditions of trade at www.siemens.com/automation/salesmaterial-as/catalog/en/terms_of_trade_en.pdf

Appendix

Conditions of sale and delivery

4. Export regulations

We shall not be obligated to fulfill this agreement if such fulfillment is prevented by any impediments arising out of national or international foreign trade or customs requirements or any embargoes or other sanctions.

Exporting may be subject to authorization. In delivery information, we label authorization obligations according to German, European and US export lists.

Our products are controlled by the U.S. authorities (goods labeled with "ECCN" not equal to "N") and may only be supplied to the stated country of the end user for sole use by the end user. Without U.S. government approval or other approval under U.S. law, the products may not be sold, transferred or otherwise forwarded to other countries or to other persons other than the specified end user, either in their original form or after further processing into other goods. Goods labeled with an "AL" not equal to "N" are subject European/national export authorization requirements.

Please note that you can also preview the export designations in the respective product description via our "Industry Mall" online catalog system. The deciding factors, however, are the AL or ECCN export designations indicated on order confirmations, delivery notes and invoices.

Unmarked items or items marked "AL:N" / "ECCN:N" or "AL:9X9999" / "ECCN: 9X9999" may require authorization based on their intended use or ultimate destination.

If you transfer goods (hardware and/or software and/or technology as well as corresponding documentation, regardless of the mode of provision) delivered by us or works and services (including all kinds of technical support) performed by us to a third party worldwide, you shall comply with all applicable national and international (re-) export control regulations.

If required to conduct export control checks, you, at our request, shall promptly provide us with all information pertaining to particular end customers, destination and intended use of goods, works and services provided by us, as well as any relevant export control restrictions.

The products listed in this catalog may be subject to European/German and/or US export regulations. Therefore, any export requiring a license is subject to approval by the competent authorities.

Errors excepted and subject to change without prior notice.

Further information can be obtained from our branch offices listed at www.siemens.com/lowvoltage/contact

Interactive Catalog	<i>Catalog</i>	Process Instrumentation and Analytics	<i>Catalog</i>
Products for Automation and Drives	CA 01	<i>Digital: Field Instruments for Process Automation</i>	FI 01
Building Control		<i>Digital: Display Recorders SIREC D</i>	MP 20
GAMMA Building Control	ET G1	<i>Digital: SIPART Controllers and Software</i>	MP 31
Drive Systems		Products for Weighing Technology	WT 10
SINAMICS G130 Drive Converter Chassis Units	D 11	<i>Digital: Process Analytical Instruments</i>	AP 01
SINAMICS G150 Drive Converter Cabinet Units		<i>Digital: Process Analytics, Components for Continuous Emission Monitoring</i>	AP 11
<i>Digital: SINAMICS PERFECT HARMONY GH180 Medium-Voltage Air-Cooled Drives (Germany Edition)</i>	D 15.1	Low-Voltage Power Distribution and Electrical Installation Technology	
SINAMICS G180 Converters – Compact Units, Cabinet Systems, Cabinet Units Air-Cooled and Liquid-Cooled	D 18.1	SENTRON · SIVACON · ALPHA	LV 10
SINAMICS S120 Chassis Format Converter Units	D 21.3	Protection, Switching, Measuring and Monitoring Devices, Switchboards and Distribution Systems	
SINAMICS S120 Cabinet Modules		Electrical Components for the Railway Industry	LV 12
SINAMICS S150 Converter Cabinet Units		Power Monitoring Made Simple	LV 14
SINAMICS S120 and SIMOTICS	D 21.4	Components for Industrial Control Panels according to UL Standards	LV 16
SINAMICS DCM DC Converter, Control Module	D 23.1	<i>Digital: Air circuit breakers and molded case circuit breakers with UL certification</i>	LV 18
SINAMICS Inverters for Single-Axis Drives · Built-In Units	D 31.1	3WT Air Circuit Breakers up to 4000 A	LV 35
SINAMICS Inverters for Single-Axis Drives · Distributed Inverters	D 31.2	3VT Molded Case Circuit Breakers up to 1600 A	LV 36
<i>Digital: SINAMICS Converters for Single-Axis Drives · SINAMICS G120X</i>	D 31.5	<i>Digital: SIVACON System Cubicles, System Lighting and System Air-Conditioning</i>	LV 50
<i>Digital: SINAMICS S210 Servo Drive System</i>	D 32	<i>Digital: ALPHA Distribution Systems</i>	LV 51
<i>Digital: SINAMICS V90 Basic Servo Drive System</i>	D 33	ALPHA FIX Terminal Blocks	LV 52
<i>Digital: SINAMICS G120P and SINAMICS G120P Cabinet pump, fan, compressor converters</i>	D 35	SIVACON S4 Power Distribution Boards	LV 56
LOHER VARIO High Voltage Motors	D 83.2	SIVACON 8PS Busbar Trunking Systems	LV 70
Flameproof, Type Series 1PS4, 1PS5, 1MV4 and 1MV5 Frame Size 355 to 1000, Power Range 80 to 7100 kW		<i>Digital: DELTA Switches and Socket Outlets</i>	ET D1
<i>Digital: Three-Phase Induction Motors SIMOTICS HV, SIMOTICS TN</i>	D 84.1	Vacuum Switching Technology and Components for Medium Voltage	HG 11.01
<i>Digital: Three-Phase Induction Motors SIMOTICS HV</i>	D 84.3	Power Supply	
High Voltage Three-phase Induction Motors	D 84.9	SITOP Power supply	KT 10.1
SIMOTICS HV Series A-compact PLUS		Safety Integrated	
<i>Digital: Modular Industrial Generators SIGENTICS M</i>	D 85.1	Safety Technology for Factory Automation	SI 10
Synchronous Motors with Permanent-Magnet Technology, HT-direct	D 86.2	SIMATIC HMI / PC-based Automation	
DC Motors	DA 12	Human Machine Interface Systems/ PC-based Automation	ST 80/ ST PC
SIMOVERT PM Modular Converter Systems	DA 45	SIMATIC Ident	
MICROMASTER 420/430/440 Inverters	DA 51.2	Industrial Identification Systems	ID 10
MICROMASTER 411/COMBIMASTER 411	DA 51.3	SIMATIC Industrial Automation Systems	
<u>Low-Voltage Three-Phase-Motors</u>		Products for Totally Integrated Automation	ST 70
SIMOTOCS S-1FG1 Servo geared motors	D 41	SIMATIC PCS 7 Process Control System	ST PCS 7
SIMOTICS Low-Voltage Motors	D 81.1	System components	
SIMOTICS FD Low-Voltage Motors	D 81.8	SIMATIC PCS 7 Process Control System	ST PCS 7 T
LOHER Low-Voltage Motors	D 83.1	Technology components	
<i>Digital: MOTOX Geared Motors</i>	D 87.1	Add-ons for the SIMATIC PCS 7 Process Control System	ST PCS 7 AO
SIMOGEAR Geared Motors	MD 50.1	SIMATIC S7-400 advanced controller	ST 400
SIMOGEAR Electric-monorail geared motors	MD 50.8	SIMATIC NET	
Light-load and heavy-load applications		Industrial Communication	IK PI
SIMOGEAR Gearboxes with adapter	MD 50.11	SIRIUS Industrial Controls	
<u>Mechanical Driving Machines</u>		<i>Digital: SIRIUS Industrial Controls</i>	IC 10
FLENDER Standard Couplings	MD 10.1		
FLENDER High Performance Couplings	MD 10.2		
FLENDER Backlash-free Couplings	MD 10.3		
FLENDER SIP Standard industrial planetary gear units	MD 31.1		
Motion Control			
SINUMERIK 840 Equipment for Machine Tools	NC 62		
SINUMERIK 808 Equipment for Machine Tools	NC 81.1		
SINUMERIK 828 Equipment for Machine Tools	NC 82		
SIMOTION Equipment for Production Machines	PM 21		
<i>Digital: Drive and Control Components for Cranes</i>	CR 1		

*Digital: These catalogs are only available as a PDF.***Siemens Industry Online Support**Digital versions of the catalogs are available on the Internet at:
www.siemens.com/lowvoltage/catalogs

Get more information

www.siemens.com/lowvoltage

Siemens AG
Energy Management
Low Voltage & Products
Postfach 10 09 53
93009 Regensburg
Germany

© Siemens AG 2019
Subject to change without prior notice
PDF (E86060-K8280-A101-A8-7600)
KG 0119 1756 En
Produced in Germany

The information provided in this catalog contains merely general descriptions or characteristics of performance which in case of actual use do not always apply as described or which may change as a result of further development of the products. An obligation to provide the respective characteristics shall only exist if expressly agreed in the terms of contract. Availability and technical specifications are subject to change without notice.

All product designations may be trademarks or product names of Siemens AG or supplier companies whose use by third parties for their own purposes could violate the rights of the owners.

Security information

Siemens provides products and solutions with industrial security functions that support the secure operation of plants, systems, machines and networks.

In order to protect plants, systems, machines and networks against cyber threats, it is necessary to implement – and continuously maintain – a holistic, state-of-the-art industrial security concept. Siemens' products and solutions constitute one element of such a concept.

Customers are responsible for preventing unauthorized access to their plants, systems, machines and networks. Such systems, machines and components should only be connected to an enterprise network or the internet if and to the extent such a connection is necessary and only when appropriate security measures (e.g. firewalls and/or network segmentation) are in place.

For additional information on industrial security measures that may be implemented, please visit

<http://www.siemens.com/industrialsecurity>.

Siemens' products and solutions undergo continuous development to make them more secure. Siemens strongly recommends that product updates are applied as soon as they are available and that the latest product versions are used. Use of product versions that are no longer supported, and failure to apply the latest updates may increase customer's exposure to cyber threats.

To stay informed about product updates, subscribe to the Siemens Industrial Security RSS Feed under **<http://www.siemens.com/industrialsecurity>**.