

Beam Clamps and Hanger Rod Supports

M-775L Clamp with Lock Nut

CAT. NO.	ROD SIZE			DESIGN LOAD LBS.	STD CTN.
	A (IN.)	B (IN.)	C (IN.)		
M-775L-1/2	1/2	3/4	2	440	50
M-775L-5/8	5/8	3/4	2	440	50
M-775L-3/4	3/4	3/4	2	500	50

Standard Finishes - GoldGalv® brand or Black (B) Malleable Iron.

EG=Electro-Galv

B=Black

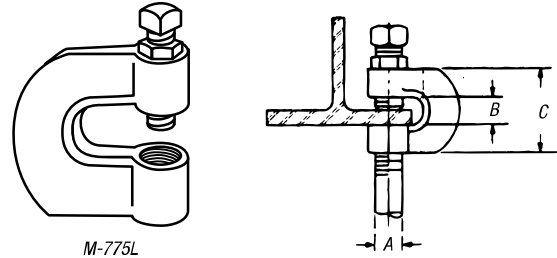

M-775L

U-579 Beam Clamp for Hanging Rod

CAT. NO.	A (IN.)	STD. CTN.
U579-3/8	3 1/2	25
U-579-1/2	4 1/4	25

Nuts and wood screws not included.

Mounting holes 1/8".

Finishes - GoldGalv® brand Malleable Iron.

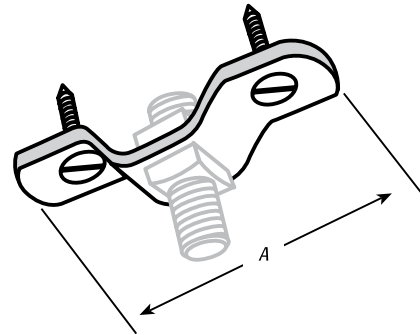

U-579 Ceiling Flange

540 Beam Clamp for Hanging Rod

CAT. NO.	DIMENSIONS (IN.)				STD. CTN.
	A	B	C	D	
540 3/8	1/8	1 1/8	1/4	7/8	25
540-5/8	1 1/16	2 1/2	3/8	2	25

Finishes - GoldGalv® brand or Black (B).

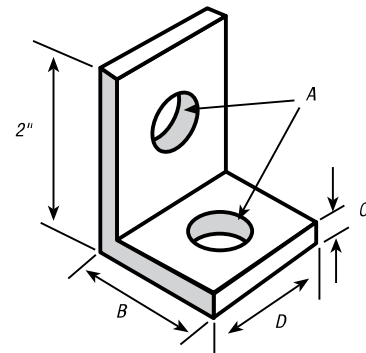

540 Side Beam Hanger Clip