



Plastic Underground Electrical Junction Boxes

Large Round • H2O Load

Cat #	Item	Top Dimensions	Bottom Dimensions	Height	Weight
		in (mm)	in (mm)	in (mm)	lbs (kg)
25010	Box	20.87 (530)	28.7 (730)	15.11 (384)	17 (7.7)
25300	Lid - Plastic*	19.69 (500)			6 (2.7)
25310	Lid - Steel	19.69 (500)			34.25 (15.6)
25800	Drain Plate	19.69 (500)			4.75 (2.16)

Notes:

- i) Tested for H2O loading with steel lid.
- ii) BC Ministry of Highways approved.
- iii) Washington State D.O.T. approved.

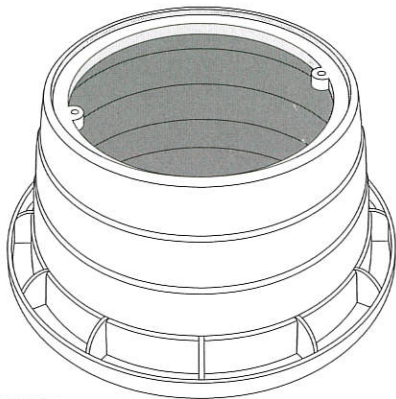

25010

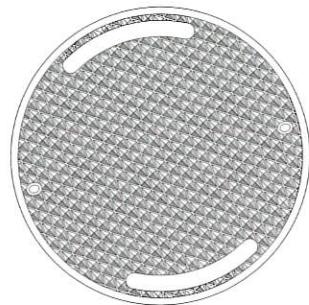

25300



25310



25800

Small Round • H2O Load

Cat #	Item	Top Dimensions	Bottom Dimensions	Height	Weight
		in (mm)	in (mm)	in (mm)	lbs (kg)
25020	Box	14.65 (372)	20 (508)	15.16 (385)	10 (4.55)
25400	Lid - Plastic*	13.66 (347)			2.5 (1.14)
25410	Lid - Steel	13.66 (347)			15.75 (7.2)
25810	Drain Plate	13.66 (347)			2 (0.91)

Notes:

- i) Tested for H2O loading with steel lid.
- ii) BC Ministry of Highways approved.
- iii) Washington State D.O.T. approved.

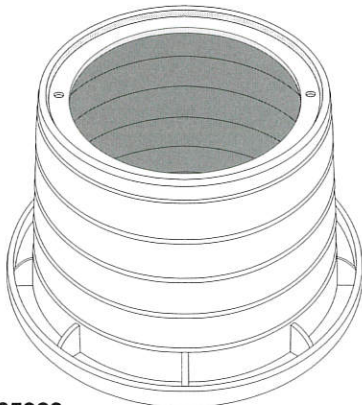

25020



25400

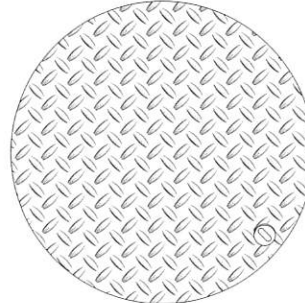

25410

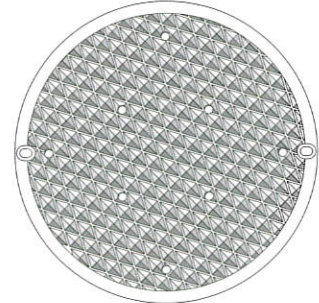

25810

Large Rectangular

Cat #	Item	Top Dimensions	Bottom Dimensions	Height	Weight
		in (mm)	in (mm)	in (mm)	lbs (kg)
25100	Large Rect.	31.6 x 18.5 (802 x 470)	37 x 24 (940 x 610)	15 (381)	20.74 (9.4)
25500	Lid - Plastic*	29.5 x 17.7 (750 x 450)			11.5 (5.2)
25510	Lid - Steel	30.3 x 17.3 (770 x 440)			40.5 (18.4)

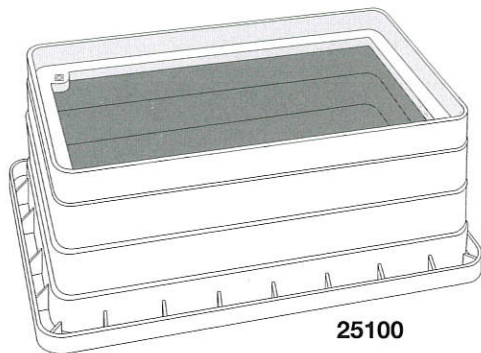

25100

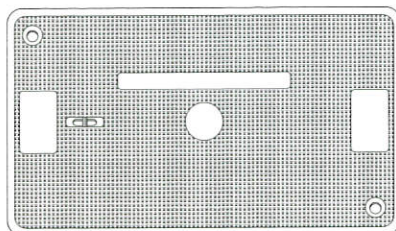

25500

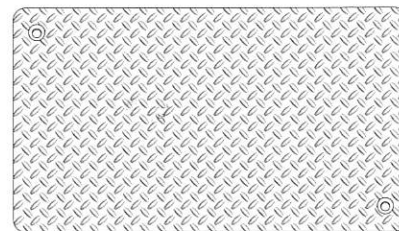

25510

Medium Rectangular

Cat #	Item	Top Dimensions	Bottom Dimensions	Height	Weight
		in (mm)	in (mm)	in (mm)	lbs (kg)
25110	Medium Rect.	26.6 x 14.6 (675 x 372)	34.45 x 22.6 (875 x 575)	15.16 (385)	21.5 (9.8)
25600	Lid - Plastic*	26.6 x 13.6 (675 x 345)			8 (2.7)
25610	Lid - Steel	26.3 x 13.8 (667 x 350)			23.25 (10.6)
25820	Drain Plate	26.6 x 13.6 (675 x 345)			3.25 (1.42)

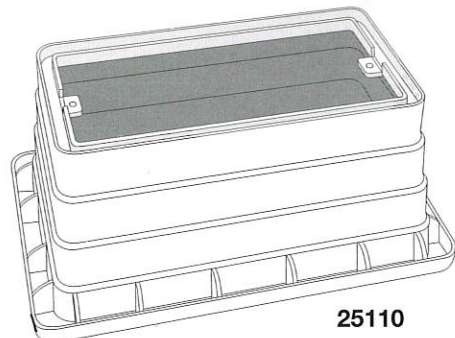

25110

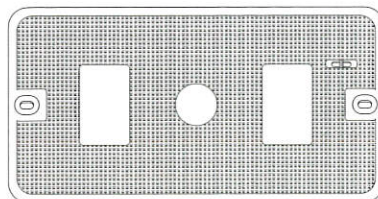

25600

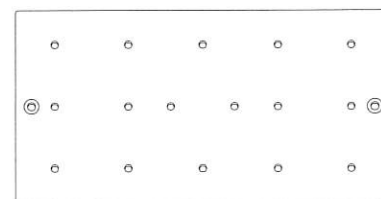

25820

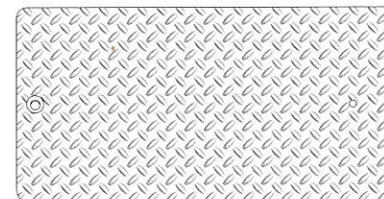

25610

Small Rectangular

Cat #	Item	Top Dimensions	Bottom Dimensions	Height	Weight
		in (mm)	in (mm)	in (mm)	lbs (kg)
25120	Small Rect.	17 x 11.75 (432 x 298)	21.2 x 15.75 (538 x 400)	12 (305)	7.5 (3.4)
25700	Lid - Plastic*	15.3 x 10.1 (389 x 257)			2.5 (1.14)
25710	Lid - Steel	15.2 x 9.9 (387 x 252)			10.75 (4.9)

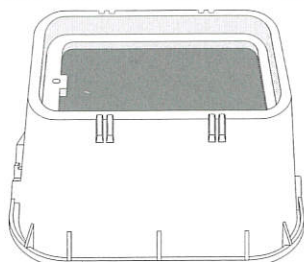

25120

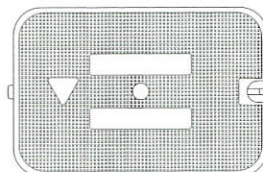

25700

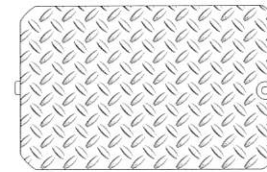

25710

Splice Pits

Cat #	Item	Top	Bottom	Height	Weight
		Dimensions	Dimensions		
		in (mm)	in (mm)	in (mm)	lbs (kg)
25200	Large	10.3 (262)	13.4 (340)	10 (254)	3.5 (1.6)
25210	Small	6.06 (154)	9.5 (240)	8.9 (226)	1.25 (0.6)

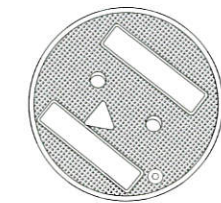
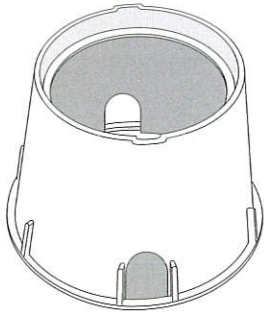

25210

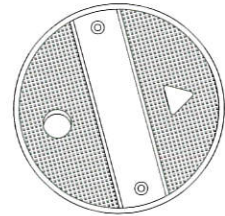
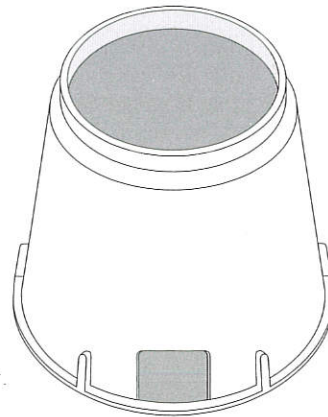

25200

Adapter Plate

Cat #	Item	Top	Weight
		Dimensions	
		in (mm)	lbs (kg)
25900	Plastic	34.25 x 21.3 (870 x 540)	7.5 (3.4)

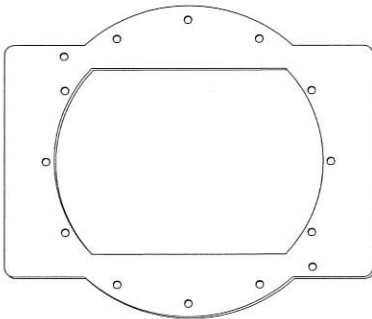

25900

Riser Ring

Cat#	Item	Height	Outside	Inside
			Diameter	Diameter
			In (mm)	In (mm)
25300-RING	Plastic Riser Ring	2 (51)	21 (533)	17 3/4 (451)

The riser ring is for use on our large round junction box. It is used for those applications where the top of the junction box needs to be raised to be level with the grade. They are stackable and are simple to install by drilling screws through the lip of the ring into the existing box.

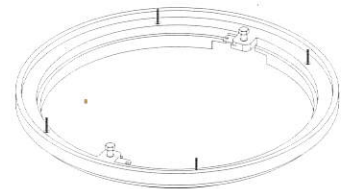

Notes

*Custom Marking

Customized marking on all plastic lids can be arranged. Please call for more information.

Warranty

Our warranty is restricted solely to the replacement and/or repair of the products under the following condition; All defects must be reported in writing within one year of purchase date (labour not included).

Western Sales

Valmont WCE
7984 River Road
Delta, BC V4G 1E3
Tel: 604-946-1256
Fax: 604-946-1203
www.valmontwce.com

Eastern Sales

Valmont WCE
100 Ellis Drive
Barrie, ON L4N 9B2
Tel: 800-645-1664
Fax: 800-367-1449
www.valmontwce.com