



## NE12-LIST

NET Price List Schedule

Effective Date: 08/01/10

Replaces: NE11

Roughing-in Products

EMT, Rigid, Aluminum Conduit & Fittings

Grounding Accessories

Conduit Bodies

Explosion-Proof Fittings

Signaling & Switches

Weatherproof Products

Flexible Conduits

PVC, DBII, ENT Conduit and Fittings





NESCO is a Canadian Corporation that manufactures and distributes electrical conduits and fittings to Electrical Wholesalers across Canada. Our manufacturing, warehouse and distribution facility in Brampton, Ontario is close to major transportation routes eastbound, westbound and all points within Ontario.

Products we manufacture include:

- Flexible Aluminum Conduit
- Steel Set Screw Couplings
- EMT Elbows
- Rigid Conduit Nipples
- Steel Cover Plates

In addition to the products we manufacture, NESCO is also a master distributor of the following product lines:

- Die Cast Fittings For EMT, both set screw and compression
- Steel Fittings for EMT, both set-screw and compression
- Aluminum Conduit Bodies
- Aluminum Flex and Liquid Tight Connectors
- Non-Metallic Liquid Tight Conduit and Fittings
- Rigid Conduit Fittings
- Grounding Accessories
- A/C Disconnects

Our product line continues to grow as our customers realize the need for a competitive source on fittings they have difficulty obtaining. The large inventory held at the Brampton location ensures that most orders are shipped complete the same day the order is placed.

Quality products and exceptional customer service differentiate Nesco from competing suppliers. Please call us at **1 (866) 446-3726** (toll free) if you have any questions regarding our product line, require any product samples, or would like to place an order!

**Represented by:**

**Atlantic Provinces:**      **S&D Marketing Limited**  
48 Trider Crescent, Unit 6 Dartmouth, NS B3B 1R6  
Tel: (902) 835-1532

**Quebec:**                      **MGB Agent Manufacturier Inc.**  
1310 blvd. des Chutes #410 Quebec, QC G6K 1S3  
Tel: (418) 614-1908

**Alberta,  
Saskatchewan**              **Roblan Cook Agencies Ltd**  
5030 13<sup>th</sup> Street, Unit 19 Calgary, AB T2G 5N9  
Tel: (403) 214-2077

**British Columbia**        **C.R. Browne & Associates**  
#8-16325 82<sup>nd</sup> Ave. Surrey, BC V3S 8K3  
Tel: (604) 591-3340

**NW Ontario  
Manitoba**                      **GB Agencies Ltd.**  
43 Red Moon Road Winnipeg, MB R3X 0C2  
Tel: (204) 219-3160



www.nescocanada.com

Table of Contents

<u>Section</u>	<u>Product Description</u>	<u>Page Number</u>
①	Roughing-in Products	13 to 64
②	Conduit Bodies	65 to 71
③	Explosion Proof Fittings	73 to 76
④	Weatherproof Products	77 to 85
⑤	Signaling & Switches	87 to 91
⑥	PVC Conduit & Fittings	93 to 102
⑥	DBII Conduit & Fittings	103 to 106
⑥	ENT Conduit & Fittings	107 to 109
⑥	Poly Pipe	110
⑦	INDEX Alpha Numeric Listing by Catalogue Number	111 to 119

When Ordering...Please use the Catalogue Number! Prices are subject to change without notice. GST / HST / QST not included.

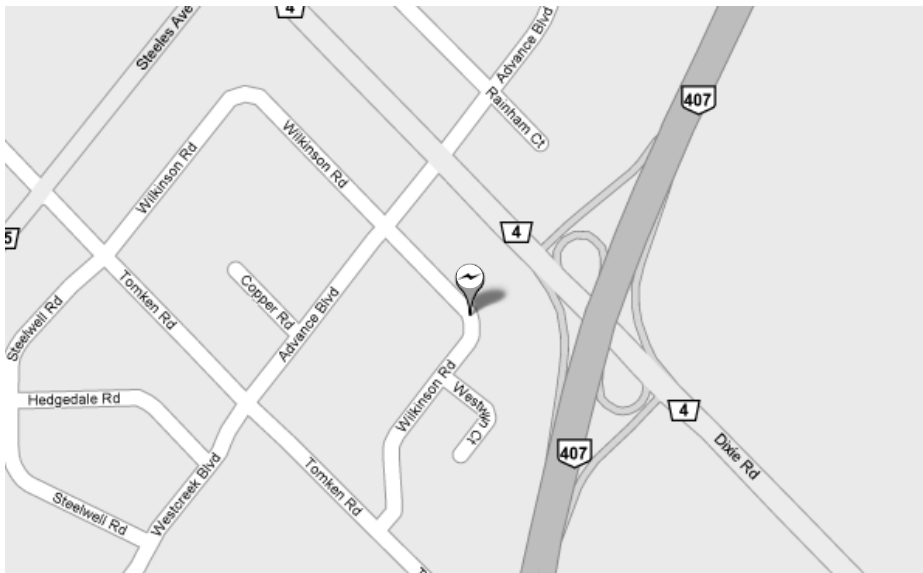

216 Wilkinson Road,  
Brampton, ON L6T 4M4

Tel: (905) 793-2218  
TF: 1 (866) 446-3726  
Fax: (905) 793-2268

**Inside Sales Contacts:**

Joe Maric  
joe@nescocanda.com

Jamie Lepp  
jamie@nescocanada.com

Rosanne Everitt  
rosanne@nescocanada.com

**NEW PRODUCTS FEATURED IN THE NE 1 1 CATALOGUE:**

**PUSH-IN CONNECTOR FOR EMT - PAGE 15**



- \* **QUICKLY JOIN EMT CONDUIT TO A BOX OR ENCLOSURE**
- \* **ZINC DIE CAST MATERIAL**
- \* **TRI-COMBO SCREW**

**COLOUR CODE EMT FITTINGS - PAGE 19 - 21**



- \* **COLORED FITTINGS MATCH COLORED EMT RACEWAYS FOR CLEAN LOOKING INSTALLATIONS**
- \* **STEEL FITTING WITH TRI-COMBO SCREW**
- \* **COLOURS AVAILABLE: RED, WHITE, BLUE, GREEN, YELLOW, BLACK, ORANGE**



**RED FIRE ALARM BOXES - PAGE 21**

- \* **NEW RED STEEL FIRE ALARM BOXES TO MEET VISUAL IDENTIFICATION**



**BONDING LOCKNUTS - PAGE 24**

- \* **USED IN HARSH VIBRATION ENVIRONMENTS TO FASTEN THREADED CONDUIT TO AN UNTHREADED OPENING IN A BOX OR ENCLOSURE**



**SEALING LOCKNUTS - STEEL- PAGE 24**

- \* **Steel locknut with PVC seal used to provide liquid tight seal when fastening threaded conduit to unthreaded opening in a box or enclosure**



**SPLIT THREADED RIGID CONDUIT COUPLING - PAGE 29**

- \* **1/2" thru 6" Split Threaded Rigid Conduit Couplings used to join two lengths of threaded rigid and IMC conduit**

## NEW PRODUCTS FEATURED IN THE NE 1 1 CATALOGUE:

### RAINTIGHT 3-PIECE COUPLING - PAGE 29



- \* Used to join two lengths of threaded rigid or IMC conduit. cULus Listed.
- \* Self-Aligning
- \* **MALLEABLE IRON**

### COMBINATION LIQUID TIGHT TO RRAINTIGHT EMT CONNECTOR - PAGE 43



- \* Used to join either metallic or non-metallic ( Type B" ) liquid tight conduit to EMT

### MULTI-ANGLE NONMETALLIC LIQUID TIGHT CONNECTOR (0-90°) - PAGE 46



- \* Eliminate inventory - the swivel design can be substituted for a Straight or 90° connector. Ships assembled with steel lock-nut and rubber O-ring.

### COMBINATION EMT TO AC/MC COUPLING PAGE 51



- \* Used to securely join EMT to two armored or metal clad cables. A labour savings, compared to the traditional junction box installation.

### STAINLESS STEEL JACK CHAIN - #10 - PAGE 54



- \* For use in corrosive environments
- \* Available in 100' boxes

### COLD WEATHER TAPE - PAGE 55



- \* **Premium quality COLD and Weather Resistant Electrical Tape**
- \* **WORKING TEMPERATURE RANGE OF -18°C TO 80°C. POLAR250 WITH ITS MEMORY (ELASTICITY), 8.5MIL THICKNESS AND ADHESION CHARACTERISTICS PROVIDES MOISTURE-TIGHT ELECTRICAL PROTECTION.**
- \* **EACH ROLL IS PACKAGED IN A PROTECTIVE PLASTIC CASE.**

## NEW PRODUCTS FEATURED IN THE NE 11 CATALOGUE:



### ELECTRICAL BOX EXTENDER / INSULATOR - PAGE 57

- \* Easier to install design. Eliminates the need to align device screws with extender holes.
- \* Continuous, smooth, nonmetallic side walls insulate device such as GFCI from metallic box.
- \* Extender does not interfere with wiring. No trimming required.



### LOW VOLTAGE DEVICE HOLDERS - NEW WORK

- \* Available as a single gang or double gang low voltage device holder
- \* To be used for new work on 2x4 or steel stud with 1/2" or 3/4" EMT.



### STEEL DATA PLATE MOUNTING BRACKET - PAGE 57

- \* Eliminates need for outlet box. Provides mounting base for securing com-















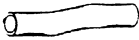













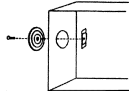

### TAYMAC WEATHERPROOF PRODUCTS































### TOPAZ WEATHERPROOF LIGHTING - PAGE 78-85

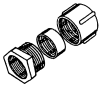

- \* High Quality weatherproof covers, outlet boxes and accessories
- \* In-Use Covers—Plastic and Metal design in a variety of depths
- \* **CAST BOXES AND COVERS AVAILABLE IN GREY, WHITE AND BRONZE**













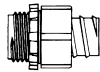





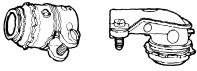

























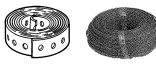

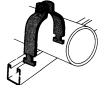









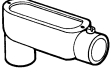
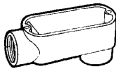
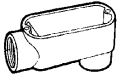

	Product	Page #		Product	Page #
	EMT Conduit	14		EMT Elbows 90°, 45°, 30°, 22½° Special Radius	14 15
	EMT Long Offset	14		Die Cast Set Screw Fittings for EMT	15
	<b>Die Cast</b> Compression Fittings for EMT	16		<b>Steel Set Screw</b> Fittings for EMT	16, 17
	<b>Steel Set Screw</b> Fittings for EMT COLOUR CODED	19, 21		<b>RED Fire Alarm</b> Boxes & Fittings	21
	<b>Steel Fittings for EMT</b> <b>Raintight</b> <b>Raintight - Gasket</b>	17 18		EMT Offset Connectors Set Screw & Compression	23
	<b>1-Hole, 2 Hole</b> EMT Rigid Aluminum	21, 22 32 39		<b>Combination EMT</b> <b>Pull Elbows</b> EMT to EMT EMT to Box	22 22 22
	<b>EMT-Rigid</b> Adapter Couplings	22		EMT to Flex Connectors	22
	Expansion Couplings for EMT	22		Bonding Jumper Assembly	22
	Steel Knockouts	23		Steel Knockout Seal	23
	Plastic Knock-out Closures	23		<b>Steel Locknuts</b> Bonding Locknuts Sealing Locknuts <b>Black or Gray Nylon</b>	24 24 24 46
	<b>Sealing</b> Locknuts <b>Sealing</b> Rings	24		Plastic Bushings Lock A Liners	25 25
	Rigid Die Cast Bushings	25		Rigid Insulated Grounding Bushings	25
	Rigid Galvanized Conduit	26		Rigid Elbows 90°, 45°, 30° Special Radius Bends	26 27
	Rigid Couplings	27		<b>Steel Set Screw</b> Fittings for <b>Rigid</b>	27
	<b>Rigid</b> Compression Fittings	28		Malleable Iron 3-Piece Coupling	28

	Product	Page #		Product	Page #
	Rigid Conduit Threaded End Cap & Plug	28		Rigid Conduit Nipples	30, 31
	Malleable Iron Split Rigid Coupling	29		Raintight 3-Piece Coupling	29
	Chase nipples	32		Offset Conduit Nipples	32
	Rigid Watertight Hub	33		<b>Rigid Pull Elbows</b> Rigid to Rigid Rigid to Box Combination	33 33 33
	Rigid Malleable Pipe Straps	33		EMT/Rigid Clamp Back	33
	Rigid Reducing Bushings	34		Threaded Male Enlargers - ZDC	34
	Rigid Floor Flanges	34		Steel Reducing Washers	35
	<b>Threaded &amp; Clamp-on Type Service Entrance Cap</b>	36		<b>Malleable Iron (CAST) FS Boxes &amp; Covers</b>	37
	Roof Flange – Galvanized with Neoprene Seal	36		Service Entrance Kits	36
	Rigid <b>Aluminum</b> Conduit	38		Rigid <b>Aluminum</b> 45°, 90°	38
	Rigid <b>Aluminum</b> Couplings	38		<b>Aluminum Locknut</b>	39
	<b>3-Piece Aluminum Coupling</b>	39		Rigid Aluminum Pipe Straps	39
	Rigid <b>Aluminum</b> Conduit Nipples	39, 40		<b>Metallic Liquid Tight</b> CSA Black Extra Flex Computer Blue	41, 42
	<b>Die Cast Fittings for Liquid Tight</b> Straight, 90°	42		Malleable Iron Liquid Tight Connectors – Straight, 90°, 45	43
	<b>Combination Liquid Tight to Raintight EMT</b>	43		60A rated A/C disconnect – non-fused Pull-out 15A GFCI receptacle	44 44









	Product	Page #		Product	Page #	
		A/C Whips, Pre-wired, and without Wires	44		<b>Extra Flex Non-Metallic Liquid Tight</b>	45
		<b>Non-metallic Liquid Tight Regular</b>	45		Non-metallic <b>One-piece Liquid Tight Fittings</b>	45
		<b>Non-metallic Liquid Tight Fittings</b>	45		Flex Hubs NPT PG	46
		Cord Grips NPT PG	46 46		Portable Cord Grips Steel Aluminum	47 48
		Aluminum Flex	49		Anti Short Bushings	49
		Die Cast & Malleable <b>Iron Flex Connectors Straight &amp; 90</b>	50, 51		Single Screw Strap Type Connectors	50
		Zinc Die Cast Snap-in Connectors	52		<b>L-Series Connectors</b> L-16, 17, 18, 19	52
		Non-Metallic "Snap-in" Connector	52		<b>Duplex Connectors</b> Straight & 90	52, 53
		Squeeze Strap Type Connector	53		Flex Connector Screw in Type	53
		Combination EMT to AC/MC Coupling	51		Clamp Connectors	53
		<b>Jack Chain</b> T10, T12, Lion Chain (#2, 3, 4) Stainless Steel (#10)	54		S-Hooks	54
		Poly Twine Polypropylene Rope	54		Cold Weather Tape	55
		Caution Tape Detectable & Non-Detectable	55		PVC Electrical Tape Rubber Splicing Tape Duct Tape	55
		EZ Wire Pulling Compound	55		Antiox Contact Compound	55
		Duct Seal Compound	55		Fire Stop Compound	55

Product	Page #	Product	Page #
 Nail Plate with Prongs	55	 Swivel Fixture Aligners	56
 Rubber Pigtail Socket	56	 Tie Wire Perforated Strapping	56
 Cable Stacker and Supports	56	 Pipe Clamps For EMT	58
 Electrical Box Extender / Insulator	57	 <b>Low Voltage</b> Device Holder for New Work <b>Steel Data Plate</b> Mounting Bracket	57
 Steel Conduit Hangers (with bolt & nut attached)	58	 Spring	58 49
 Beam Clamps	58	 Knock-out bushing – 6/6 Nylon	59
 Insulator Bushings for EMT Conduit	59	 Universal Stud Bushing	59
 Ground Clamps	60	 Ground Rod Clamps	60
 <b>Ground Rods</b> Copper Galvanized	60	 Ground Plate with Electrode and Ground Connector	60
 Round Cover - White	61	 Steel Cover Plates (52C1, 54C1...)	61 – 64
 Combination Conduit Bodies (1/2" – 2") Threaded/Set Screw	66 – 68	 <b>Cast Aluminum</b> Rigid Conduit Bodies Threaded - (2½" - 4")	66 – 68
 <b>Malleable Iron</b> Rigid Conduit Bodies (1/2" - 4")	69 – 71	 Mogul LB's	71
 Covers & Gaskets Steel, Aluminum	68, 71	 <b>Explosion-Proof Fittings</b>	74 – 76
 <b>TAYMAC</b> Weatherproof Products	78 – 85	 <b>Topaz</b> Vapourproof Fixture	84
 <b>TAYMAC</b> Weatherproof Plastic Products	85	 Signaling & Switches	88 – 91



Product			Product		
	Product	Page #		Product	Page #
<b>PVC</b>	Conduit & Fittings	94 94 - 102		PVC Cement & Primer	103
<b>DBII</b>	Duct (underground) Conduit & Fittings	103 103 - 106		Monobloc Spacers	106
<b>ENT</b>	ENT Conduit & Fittings	107 107 - 108		Slab boxes for ENT	108
	Non-metallic Light Fixtures	108, 109	<b>POLY PIPE</b>	Poly Pipe Utility, CSA SDR Conduit	110

**EMT**

**Hot Dip Galvanized Rigid**

**Rigid Aluminum**

**EMT  
Conduit**

Catalogue Number	Size / Diameter	Weight (lbs)/100 ft.	Sling	Bundle
<b>ELECTRICAL METALLIC TUBING - 10' LENGTHS</b>				
EMT-05	1/2"	28.5	7,000	100
EMT-07	3/4"	43.5	5,000	100
EMT-10	1"	64.0	3,000	100
EMT-12	1-1/4"	95.0	2,000	50
EMT-15	1-1/2"	110.0	1,500	50
EMT-20	2"	140.0	1,200	30
EMT-25	2-1/2"	205.0	610	10
EMT-30	3"	325.0	510	10
EMT-35	3-1/2"	350.0	370	10
EMT-40	4"	370.0	300	10

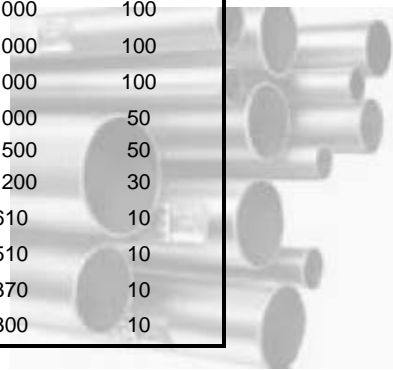

**RIGID**

- HDG

**EACH 10' LENGTH HAS A COUPLING ATTACHED TO ONE END AND A THREAD PROTECTOR ON THE OTHER.**

RIG-05	1/2"	79.0	2,500	100
RIG-07	3/4"	105.0	2,000	50
RIG-10	1"	153.0	1,250	50
RIG-12	1-1/4"	201.0	900	10
RIG-15	1-1/2"	249.0	800	10
RIG-20	2"	322.0	600	10
RIG-25	2-1/2"	527.0	370	10
RIG-30	3"	682.0	300	10
RIG-35	3-1/2"	831.0	250	10
RIG-40	4"	972.3	200	10
RIG-50	5"	1,313.6	150	10
RIG-60	6"	1,745.3	100	10

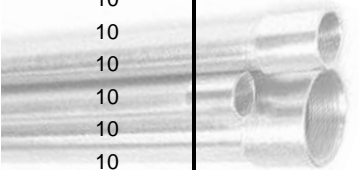

**RIGID**

ALUMINUM

**EACH 10' LENGTH HAS A COUPLING ATTACHED TO ONE END AND A THREAD PROTECTOR ON THE OTHER.**

CA-05	1/2"	28.0	1,000	100
CA-07	3/4"	38.0	1,000	50
CA-10	1"	56.0	500	50
CA-12	1-1/4"	76.0	250	10
CA-15	1-1/2"	92.0	250	10
CA-20	2"	125.0	200	10
CA-25	2-1/2"	195.0	100	10
CA-30	3"	265.0	100	10
CA-35	3-1/2"	315.0	100	10
CA-40	4"	375.0	100	10
CA-50	5"	509.0	100	10
CA-60	6"	680.0	100	10

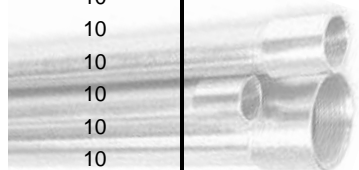

\* Prices are in Canadian Dollars and F.O.B. Nesco Inc. warehouse.

\* Prices are subject to change without notice.

EMT.RGD.AL





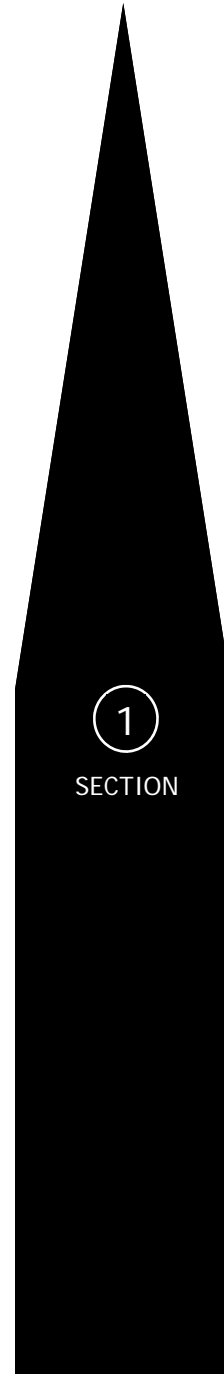

Roughing-in  
Products



1

SECTION

August 1, 2010

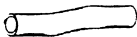
	Catalogue Number	Alternate Cat. No.	US Packaging			CDN Packaging		List Price
			Size	Sling	Bundle	Sling	Bundle	
<b>EMT Conduit</b>			Weight (lbs.) / 100'					per 100'
	EMT-05	28.5	1/2"	7000	100	2500	100	\$ 91.69
	EMT-07	43.5	3/4"	5000	100	2000	100	\$ 150.39
	EMT-10	64.0	1"	3000	50	1000	100	\$ 221.07
	EMT-12	95.0	1-1/4"	2000	50	500	50	\$ 332.02
	EMT-15	110.0	1-1/2"	1500	50	500	50	\$ 405.62
	EMT-20	140.0	2"	1200	-	510	30	\$ 495.75
	EMT-25	205.0	2-1/2"	610	-	250	-	\$ 1,049.48
	EMT-30	325.0	3"	510	-	200	-	\$ 1,299.48
	EMT-35	350.0	3-1/2"	370	-	200	-	\$ 2,115.00
	EMT-40	370.0	4"	300	-	100	-	\$ 2,130.08
<b>90° EMT Elbow</b>						SKID QTY.		
	9ELBT05	81	1/2"				50	\$ 943.02
	9ELBT07	82	3/4"				25	\$ 1,078.00
	9ELBT10	83	1"				25	\$ 1,680.68
	9ELBT12	84	1-1/4"				20	\$ 2,317.59
	9ELBT15	85	1-1/2"				15	\$ 2,945.00
	9ELBT20	86	2"				10	\$ 4,363.33
	9ELBT25	87	2-1/2"			156	1	\$ 8,023.21
	9ELBT30	88	3"			88	1	\$ 12,829.53
	9ELBT35	89	3-1/2"			54	1	\$ 14,112.48
	9ELBT40	89A	4"			40	1	\$ 20,389.29
<b>45° EMT Elbow</b>								
	4ELBT05	21	1/2"				50	\$ 943.02
	4ELBT07	22	3/4"				25	\$ 1,078.00
	4ELBT10	23	1"				25	\$ 1,680.68
	4ELBT12	24	1-1/4"				20	\$ 2,317.59
	4ELBT15	25	1-1/2"				20	\$ 2,945.00
	4ELBT20	26	2"				15	\$ 4,363.33
	4ELBT25	27	2-1/2"				1	\$ 8,023.21
	4ELBT30	28	3"				1	\$ 12,829.53
	4ELBT35	29	3-1/2"				1	\$ 14,112.48
	4ELBT40	30	4"				1	\$ 20,389.29
<b>30° EMT Elbow</b>								
	3ELBT12		1-1/4"				1	\$ 2,317.59
	3ELBT15		1-1/2"				1	\$ 2,945.00
	3ELBT20		2"				1	\$ 4,363.33
	3ELBT25		2-1/2"				1	\$ 8,023.21
	3ELBT30		3"				1	\$ 12,829.53
	3ELBT35		3-1/2"				1	\$ 14,112.48
	3ELBT40		4"				1	\$ 20,389.29
<b>22½° EMT Elbow</b>								
	225ELBT12		1-1/4"				1	\$ 2,317.59
	225ELBT15		1-1/2"				1	\$ 2,945.00
	225ELBT20		2"				1	\$ 4,363.33
	225ELBT25		2-1/2"				1	\$ 8,023.21
	225ELBT30		3"				1	\$ 12,829.53
	225ELBT35		3-1/2"				1	\$ 14,112.48
	225ELBT40		4"				1	\$ 20,389.29
<b>EMT Long Offset</b>								
	LMO12-EMT		1-1/4"				20	\$ 1,844.00
	LMO15-EMT		1-1/2"				20	\$ 2,345.00
	LMO20-EMT		2"				8	\$ 3,475.00

Catalogue Number	Alternate Cat. No.	Size or Description	Packaging		List Price
			Case	Box	

**Large Radius EMT Elbows - Special Order - Call for Delivery Details**

Size	Radius					Case	Box	List Price
	18"	24"	36"	48"	60"			
1-1/4"						1		\$
1-1/2"						1		\$
2"						1		\$
2-1/2"						1		\$
3"						1		\$
3-1/2"						1		\$
4"						1		\$

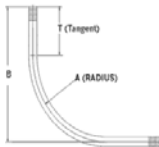

**Dimensions of Large Radius 90° Elbows**

Radius (A)	Tangent (T)	Offset (B)	Unbent Length
18"	10"	28"	48"
24"	11"	35"	59"
36"	11"	47"	78"
48"	12"	60"	100"
60"	12"	72"	118"

**Zinc Die Cast Set Screw PUSH-IN Connector for EMT --- Quickly join EMT conduit to a box or enclosure without the use of a locknut.**



1701-DC		1/2"	500	50	\$	45.84
1702-DC		3/4"	250	25	\$	86.67



**Zinc Die Cast Set Screw Connector for EMT**



230-DC2	631	1/2"	500	50	\$	60.88
231-DC2	632	3/4"	250	25	\$	102.04
232-DC2	633	1"	250	25	\$	178.31
233-DC2	634	1-1/4"	100	10	\$	317.42
234-DC2	635	1-1/2"	100	10	\$	516.31
235-DC2	636	2"	60	10	\$	638.08
236-DC2	637	2-1/2"	-	12	\$	1,520.79
237-DC2	638	3"	-	12	\$	1,892.15
238-DC2	639	3 1/2"	-	6	\$	1,876.77
239-DC2	640	4"	-	6	\$	2,897.27

**Zinc Die Cast Set Screw Connector for EMT - Insulated Throat**







230-DCI2	631i	1/2"	500	50	\$	94.25
231-DCI2	632i	3/4"	250	25	\$	145.81
232-DCI2	633i	1"	250	25	\$	252.42
233-DCI2	634i	1-1/4"	100	10	\$	481.65
234-DCI2	635i	1-1/2"	100	10	\$	720.63
235-DCI2	636i	2"	60	10	\$	893.54
236-DCI2	637i	2-1/2"	-	12	\$	2,750.58
237-DCI2	638i	3"	-	12	\$	3,420.73
238-DCI2	639i	3 1/2"	-	6	\$	3,780.73
239-DCI2	640i	4"	-	6	\$	4,626.04





**Zinc Die Cast Set Screw Coupling for EMT**





240-DC	641	1/2"	500	50	\$	65.44
241-DC	642	3/4"	250	25	\$	107.25
242-DC	643	1"	250	25	\$	187.42
243-DC	644	1-1/4"	100	10	\$	345.79
244-DC	645	1-1/2"	100	10	\$	496.60
245-DC	646	2"	60	10	\$	692.04
246-DC	647	2-1/2"	-	12	\$	1,424.38
247-DC	648	3"	-	12	\$	1,805.48
248-DC	649	3 1/2"	-	6	\$	1,970.75
249-DC	650	4"	-	6	\$	2,411.29

	Catalogue Number	Alternate Cat. No.	Size or Description	Case	Box	Packaging	List Price
<b>Zinc Die Cast Compression Connector for EMT</b>							
	250-DC2	651	1/2"	500	50	\$	99.88
	251-DC2	652	3/4"	250	25	\$	166.19
	252-DC2	653	1"	150	15	\$	282.75
	253-DC2	654	1-1/4"	100	10	\$	503.10
	254-DC2	655	1-1/2"	40	10	\$	709.15
	255-DC2	656	2"	-	10	\$	1,025.27
	256-DC2	657	2-1/2"	-	12	\$	2,197.00
	257-DC2	658	3"	-	12	\$	2,687.54
	258-DC2	659	3-1/2"	-	6	\$	3,351.65
	259-DC2	660	4"	-	6	\$	4,100.85
<b>Zinc Die Cast Compression Connector for EMT - Insulated Throat</b>							
	250-DCI2	651i	1/2"	500	50	\$	162.50
	251-DCI2	652i	3/4"	250	25	\$	212.13
	252-DCI2	653i	1"	150	15	\$	356.42
	253-DCI2	654i	1-1/4"	100	10	\$	729.29
	254-DCI2	655i	1-1/2"	40	10	\$	1,049.10
	255-DCI2	656i	2"	-	10	\$	1,454.92
	256-DCI2	657i	2-1/2"	-	12	\$	6,321.25
	257-DCI2	658i	3"	-	12	\$	7,566.00
	258-DCI2	659i	3-1/2"	-	6	\$	9,784.02
	259-DCI2	660i	4"	-	6	\$	11,971.04
<b>Zinc Die Cast Compression Coupling for EMT</b>							
	260-DC	661	1/2"	500	50	\$	150.15
	261-DC	662	3/4"	250	25	\$	200.21
	262-DC	663	1"	150	15	\$	320.46
	263-DC	664	1-1/4"	100	10	\$	610.13
	264-DC	665	1-1/2"	40	10	\$	911.08
	265-DC	666	2"	-	10	\$	1,172.38
	266-DC	667	2-1/2"	-	12	\$	2,856.10
	267-DC	668	3"	-	12	\$	3,308.71
	268-DC	669	3-1/2"	-	6	\$	4,237.60
	269-DC	670	4"	-	6	\$	5,185.92
<b>Steel Set Screw Connector for EMT</b>							
	SC-05	631S	1/2"	500	50	\$	75.35
	SC-07	632S	3/4"	250	25	\$	141.84
	SC-10	633S	1"	200	20	\$	235.97
	SC-12	634S	1-1/4"	-	25	\$	448.26
	SC-15	635S	1-1/2"	-	25	\$	638.07
	SC-20	636S	2"	-	20	\$	909.44
	SC-25	637S	2-1/2"	-	20	\$	2,958.06
	SC-30	638S	3"	-	12	\$	3,545.06
	SC-35	639S	3-1/2"	-	8	\$	3,772.00
	SC-40	640S	4"	-	15	\$	4,679.71
<b>Steel Set Screw Connector for EMT - Insulated</b>							
	SCI-05	631Si	1/2"	500	50	\$	116.61
	SCI-07	632Si	3/4"	250	25	\$	183.34
	SCI-10	633Si	1"	200	20	\$	295.30
	SCI-12	634Si	1-1/4"	-	25	\$	555.30
	SCI-15	635Si	1-1/2"	-	25	\$	762.45
	SCI-20	636Si	2"	-	20	\$	1,077.71
	SCI-25	637Si	2-1/2"	-	20	\$	3,974.66
	SCI-30	638Si	3"	-	12	\$	4,734.48
	SCI-35	639Si	3-1/2"	-	8	\$	4,985.00
	SCI-40	640Si	4"	-	15	\$	6,903.07



	Catalogue Number	Alternate Cat. No.	Size or Description	Packaging		List Price
				Case	Box	
<b>Steel Set Screw Coupling for EMT</b>						
	SCP-05	641S	1/2"	500	50	\$ 106.56
	SCP-07	642S	3/4"	250	25	\$ 167.68
	SCP-10	643S	1"	100	10	\$ 265.63
	SCP-12	644S	1-1/4"	-	25	\$ 529.35
	SCP-15	645S	1-1/2"	-	25	\$ 772.73
	SCP-20	646S	2"	-	20	\$ 1,036.33
	SCP-25	647S	2-1/2"	-	12	\$ 2,070.99
	SCP-30	648S	3"	-	10	\$ 2,453.35
	SCP-35	649S	3-1/2"	-	6	\$ 2,314.52
	SCP-40	650S	4"	-	10	\$ 3,276.09
<b>Steel Compression Connector for EMT - concrete tight</b>						
	RTSC-05	651S	1/2"	250	25	\$ 199.13
	RTSC-07	652S	3/4"	250	25	\$ 275.44
	RTSC-10	653S	1"	100	10	\$ 431.64
	RTSC-12	654S	1-1/4"	-	25	\$ 840.08
	RTSC-15	655S	1-1/2"	-	25	\$ 1,225.54
	RTSC-20	656S	2"	-	20	\$ 1,772.96
	RTSC-25	657S	2-1/2"	-	12	\$ 5,774.29
	RTSC-30	658S	3"	-	10	\$ 7,948.73
	RTSC-35	659S	3-1/2"	-	8	\$ 8,725.16
	RTSC-40	660S	4"	-	8	\$ 12,276.83
<b>Steel Compression Connector for EMT - Insulated Throat - concrete tight</b>						
	RTSCI-05	651Si	1/2"	250	50	\$ 239.80
	RTSCI-07	652Si	3/4"	250	25	\$ 333.68
	RTSCI-10	653Si	1"	100	20	\$ 531.51
	RTSCI-12	654Si	1-1/4"	-	25	\$ 1,067.32
	RTSCI-15	655Si	1-1/2"	-	25	\$ 1,560.90
	RTSCI-20	656Si	2"	-	20	\$ 2,332.68
	RTSCI-25	657Si	2-1/2"	-	12	\$ 9,556.52
	RTSCI-30	658Si	3"	-	12	\$ 12,410.65
	RTSCI-35	659Si	3-1/2"	-	8	\$ 13,195.82
	RTSCI-40	660Si	4"	-	8	\$ 18,567.30
<b>Steel Compression Coupling for EMT - concrete tight</b>						
	RTSCP-05	661S	1/2"	250	25	\$ 228.32
	RTSCP-07	662S	3/4"	250	25	\$ 317.78
	RTSCP-10	663S	1"	100	10	\$ 480.55
	RTSCP-12	664S	1-1/4"	-	25	\$ 869.14
	RTSCP-15	665S	1-1/2"	-	25	\$ 1,266.45
	RTSCP-20	666S	2"	-	20	\$ 1,723.32
	RTSCP-25	667S	2-1/2"	-	16	\$ 7,091.80
	RTSCP-30	668S	3"	-	12	\$ 8,579.99
	RTSCP-35	669S	3-1/2"	-	8	\$ 9,748.48
	RTSCP-40	670S	4"	-	8	\$ 13,716.68

Catalogue Number	Alternate Cat. No.	Size or Description	Packaging		List Price
			Case	Box	
<b>Rain Tight - Steel Compression Connector for EMT</b>					
	651SRT	1/2"	250	25	\$ 278.78
	652SRT	3/4"	250	25	\$ 385.62
	653SRT	1"	100	10	\$ 604.30
	654SRT	1-1/4"	-	25	\$ 1,176.11
	655SRT	1-1/2"	-	20	\$ 1,715.76
	656SRT	2"	-	15	\$ 2,482.14
	657SRT	2-1/2"	-	12	\$ 8,084.01
	658SRT	3"	-	6	\$ 11,128.22
	659SRT	3-1/2"	-	5	\$ 12,215.22
	660SRT	4"	-	6	\$ 17,187.56

<b>Rain Tight - Steel Compression Connector for EMT - Insulated Throat</b>					
	651SIRT	1/2"	250	50	\$ 335.72
	652SIRT	3/4"	250	25	\$ 467.15
	653SIRT	1"	100	20	\$ 744.11
	654SIRT	1-1/4"	-	25	\$ 1,494.25
	655SIRT	1-1/2"	-	20	\$ 2,185.26
	656SIRT	2"	-	15	\$ 3,265.75
	657SIRT	2-1/2"	-	12	\$ 13,379.13
	658SIRT	3"	-	6	\$ 17,374.91
	659SIRT	3-1/2"	-	5	\$ 18,474.15
	660SIRT	4"	-	6	\$ 25,994.22

<b>Rain Tight - Steel Compression Coupling for EMT</b>					
	661SRT	1/2"	250	25	\$ 319.65
	662SRT	3/4"	250	25	\$ 444.89
	663SRT	1"	100	10	\$ 672.77
	664SRT	1-1/4"	-	25	\$ 1,216.80
	665SRT	1-1/2"	-	20	\$ 1,773.03
	666SRT	2"	-	15	\$ 2,412.65
	667SRT	2-1/2"	-	6	\$ 9,928.52
	668SRT	3"	-	6	\$ 12,011.99
	669SRT	3-1/2"	-	5	\$ 13,647.87
	670SRT	4"	-	3	\$ 19,203.35





**The Raintight Difference:**









Listing agencies recently implemented a specification revision that caused industry standard split ring compression connectors to be incapable of passing raintight testing. Bridgeport solved this issue by developing a patented EMT raintight design and became the industry's first manufacturer to meet the more stringent raintight listing requirements, ensuring their products consistently and effectively excluded water. This allowed Bridgeport to mark their fittings "RAINTIGHT". Some manufacturers have elected to colour code their raintight gland nuts for identification purposes. Exclusive to Bridgeport is the use of the colour blue on their zinc EMT raintight fittings.

Nesco inventories raintight fittings in both steel and zinc die cast material from 1/2" - 4" trade size.

**BRIDGEPORT - Colour Code Fittings for Application Specific Installations**

<u>Colour</u>	<u>Suggested Application</u>
Black	Colour coded BLACK to match EMT for easy identification. Use with black EMT in dark coloured areas or in open architecture applications. Concrete-tight. Furnished with Tri-Drive Screw
Blue	Colour coded BLUE to match EMT for easy identification. Use with blue EMT for low voltage wiring, data comm/video and network security applications. Concrete-tight. Furnished with Tri-Drive Screw
Green	Colour coded GREEN to match EMT for easy identification. Use with green EMT for grounding/bonding, hospital and healthcare such as nurse call station applications. Concrete-tight. Furnished with Tri-Drive
Orange	Colour coded ORANGE to match EMT for easy identification. Use with orange EMT in construction/research, fiber optic isolated circuits and auto repair/maintenance applications. Concrete-tight. Furnished with Tri-Drive
RED™ FIRE ALARM	Colour coded RED to match EMT for easy identification. Use with red EMT for emergency circuits, fire alarm and security system applications. Concrete-tight. Furnished with Tri-Drive Screw
White	Colour coded WHITE to match EMT for easy identification. Use with white EMT in light coloured areas and open architecture applications. Concrete-tight. Furnished with Tri-Drive Screw
Yellow	Colour coded YELLOW to match EMT for easy identification. Use with yellow EMT in special equipment, caution areas and high voltage applications. Concrete-tight. Furnished with Tri-Drive Screw

	Catalogue Number	Alternate Cat. No.	Size or Description	Case	Packaging Box		List Price
<b>BLACK - Steel Set Screw Connector for EMT</b>							
	231-SBLK		3/4"	250	25	\$	181.33
<b>BLUE - Steel Set Screw Connector for EMT</b>							
	230-SBLU		1/2"	500	50	\$	105.35
	231-SBLU		3/4"	250	25	\$	181.33
	232-SBLU		1"	250	25	\$	300.48
	233-SBLU		1-1/4"	120	20	\$	563.64
<b>GREEN - Steel Set Screw Connector for EMT</b>							
	231-SG		3/4"	250	25	\$	181.33
<b>ORANGE - Steel Set Screw Connector for EMT</b>							
	231-SO		3/4"	250	25	\$	181.33

	Catalogue Number	Alternate Cat. No.	Size or Description	Packaging		List Price
				Case	Box	
<b>RED™ Fire Alarm - Steel Set Screw Connector for EMT</b>						
	230-SR		1/2"	500	50	\$ 105.35
	231-SR		3/4"	250	25	\$ 181.33
	232-SR		1"	250	25	\$ 300.48
	233-SR		1-1/4"	120	20	\$ 563.64
	234-SR		1-1/2"	60	10	\$ 744.46
	235-SR		2"	30	5	\$ 1,120.41
	236-SR		2-1/2"	10	2	\$ 3,195.72
	237-SR		3"	10	2	\$ 4,361.02
<b>WHITE - Steel Set Screw Connector for EMT</b>						
	231-SW		3/4"	250	25	\$ 181.33
<b>YELLOW - Steel Set Screw Connector for EMT</b>						
	231-SY		3/4"	250	25	\$ 181.33
<b>BLACK - Steel Set Screw Coupling for EMT</b>						
	241-BLK		3/4"	250	25	\$ 214.36
<b>BLUE - Steel Set Screw Coupling for EMT</b>						
	240-SBLU		1/2"	500	50	\$ 135.36
	241-SBLU		3/4"	250	25	\$ 214.36
	242-SBLU		1"	250	25	\$ 319.71
	243-SBLU		1-1/4"	120	20	\$ 631.58
<b>GREEN - Steel Set Screw Coupling for EMT</b>						
	241-SG		3/4"	250	25	\$ 214.36
<b>ORANGE - Steel Set Screw Coupling for EMT</b>						
	241-SO		3/4"	250	25	\$ 214.36
<b>RED™ Fire Alarm - Steel Set Screw Coupling for EMT</b>						
	240-SR		1/2"	500	50	\$ 135.36
	241-SR		3/4"	250	25	\$ 214.36
	242-SR		1"	250	25	\$ 319.71
	243-SR		1-1/4"	120	20	\$ 631.58
	244-SR		1-1/2"	60	10	\$ 969.99
	245-SR		2"	30	5	\$ 1,270.78
	246-SR		2-1/2"	10	2	\$ 2,624.29
	247-SR		3"	10	2	\$ 2,970.05

Catalogue Number	Alternate Cat. No.	Size or Description	Packaging		List Price
			Case	Box	

**WHITE - Steel Set Screw Coupling for EMT**



241-SW



3/4"

250

25

\$

214.36

**YELLOW - Steel Set Screw Coupling for EMT**



241-SY

3/4"

250

25

\$

214.36

**RED Fire Alarm Boxes**



NEW red steel fire alarm boxes to meet visual identification requirements for fire alarm installation. Available in a variety of sizes to accommodate both old and new work requirements. Provides positive visual identification and can withstand the harshest environmental conditions.











Please consult  
**2009**  
**Bridgeport**  
**Catalogue** -  
Page 24 for  
knock-out  
configuration





			Cu In. Capacity			
FA-400	1-1/2" Deep Drawn Box 4" Square		21.0	50	\$	868.00
FA-401	2 1/8" Deep Welded Box 4" Square		30.3	50	\$	1,470.00
FA-402	2 1/8" Deep Welded Box 4" Square with Mounting Bracket		30.3	50	\$	1,284.00
FA-403	Flat 4" Square Cover		n/a	50	\$	305.20
FA-404	2 1/8" Deep Welded Box 4" Square extension ring		30.3	50	\$	1,114.40
FA-411	2 1/8" Deep Welded Box 4-11/16" Square		42.0	50	\$	1,778.00





**1-hole Strap for EMT - Snap on Type**

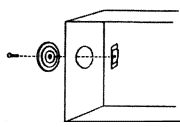
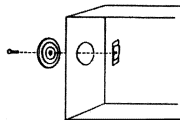

510BX	3/8" One hole BX Strap	14/2 - 10/3	1000	100	\$	9.10
511		1/2"	1000	100	\$	9.83
512		3/4"	1000	100	\$	12.93
513		1"	500	50	\$	27.57
514		1-1/4"	250	25	\$	47.71
515		1-1/2"	100	10	\$	73.22
516		2"	100	10	\$	90.49
517		2-1/2"	50	-	\$	191.90
518		3"	25	-	\$	267.30
519		3-1/2"	25	-	\$	402.30
520		4"	25	-	\$	410.30

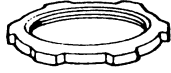
	Catalogue Number	Alternate Cat. No.	Size or Description	Case	Box	Packaging	List Price
<b>2-hole Strap for EMT</b>							
	521		1/2"	500	50	\$	9.26
	522		3/4"	500	50	\$	11.10
	523		1"	500	50	\$	16.59
	524		1-1/4"	200	20	\$	24.71
	525		1-1/2"	200	20	\$	33.64
	526		2"	50	-	\$	44.28
	527		2-1/2"	25	-	\$	132.94
	528		3"	25	-	\$	164.27
	529		3-1/2"	25	-	\$	220.11
	530		4"	25	-	\$	300.87
<b>EMT to EMT Pull Elbow - Zinc Die Cast</b>							
	61-DC	381	1/2"	100	10	\$	782.00
	62-DC	382	3/4"	50	5	\$	1,229.58
	63-DC	383	1"	25	-	\$	2,802.00
	64-DC	384	1-1/4"	20	-	\$	3,519.54
<b>EMT to Box Pull Elbow - Zinc Die Cast</b>							
	51-DC	371	1/2"	100	10	\$	783.75
	52-DC	372	3/4"	50	5	\$	1,284.40
	373		1"	10	-	\$	2,550.00
<b>COMBINATION TYPE - Rigid OR EMT to Box (Threaded for Rigid - Set-Screw for EMT)</b>							
	71-DCA		1/2"	100	10	\$	825.00
	72-DCA		3/4"	50	5	\$	1,352.00
<b>COMBINATION TYPE - Rigid to Rigid OR EMT to EMT Threaded for Rigid - Set-Screw for EMT)</b>							
	81-DCA		1/2"	100	10	\$	861.08
	82-DCA		3/4"	50	5	\$	1,458.00
	83-DCA		1"	-	25	\$	3,083.00
	84-DCA		1-1/4"	-	20	\$	3,654.00
<b>EMT to Rigid Set Screw Coupling - Steel</b>							
	391S		1/2" x 1/2"	250	25	\$	177.11
	392S		3/4" x 3/4"	100	10	\$	266.66
	393S		1" x 1"	100	10	\$	390.73
<b>EMT to Flexible Conduit Coupling - Zinc Die Cast</b>							
	280-DC2	180	1/2" x 3/8"	100	25	\$	324.35
	281-DC2	181	1/2" x 1/2"	250	25	\$	459.13
	282-DCX	282-DCX	3/4" x 1/2"	100	25	\$	779.00
	282-DCX	182	3/4" x 3/4"	100	25	\$	640.83
	283-DC	182A	1" x 1"	100	10	\$	805.21
<b>EMT Expansion Joints for EMT Conduit - 2-1/2" thru 4" Suitable for use on EMT or Rigid Conduit</b>							
	EC-075		3/4"	60	15	\$	338.98
	EC-100		1"	40	10	\$	402.06
	EC-125		1-1/4"	40	8	\$	598.30
	EC-150		1-1/2"	30	6	\$	753.87
	EC-200		2"	-	4	\$	996.14
	EC-250		2-1/2"	-	1	\$	5,844.70
	EC-300		3"	-	1	\$	6,039.60
	EC-350		3 1/2"	-	1	\$	6,655.95
	EC-400		4"	-	1	\$	7,207.99
	<b>Bonding Jumper Assembly - Bronze ground clamps and copper bonding strip.</b>						
	BJ-100		1/2" thru 1"	10	1	\$	5,214.58
	BJ-200		1-1/2" thru 2"	10	1	\$	6,923.92
	BJ-400		2-1/2" thru 4"	10	1	\$	15,421.21

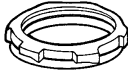
	Catalogue Number	Alternate Cat. No.	Size or Description	Case	Packaging Box	List Price
<b>EMT Offset Connectors, EMT to BOX</b>						
	<b>Set Screw Type</b>					
	1620-DC2	771	1/2"	100	10	\$ 625.52
	1621-DC2	772	3/4"	100	10	\$ 780.21
	1622-DC2	773	1"	100	10	\$ 1,014.44
	<b>Compression Type</b>					
	781		1/2"	200	20	\$ 765.48
	782		3/4"	100	10	\$ 988.06
<b>EMT to Liquid Tight - Compression Type</b>						
	271		1/2" X 1/2"	250	25	\$ 963.90
	272		3/4" X 3/4"	200	20	\$ 1,178.10
	273		1" X 1"	100	10	\$ 1,480.50
<b>Knockout Closures - Steel</b>						
	KO50		1/2"	1000	100	\$ 27.23
	KO51		3/4"	1000	100	\$ 33.75
	KO52		1"	500	50	\$ 46.79
	KO53		1-1/4"	500	50	\$ 65.44
	KO54		1-1/2"	500	50	\$ 91.29
	KO55		2"	100	10	\$ 122.30
<b>Knockout Closures - Plastic</b> Snap-in / Snap-out KO filler that fits all metallic and non-metallic materials from 1/32" to 1.8"						
	ETD50		1/2"	minimum order bag quantity	50	\$ 36.00
	ETD75		3/4"		50	\$ 48.00
	ETD100		1"		25	\$ 60.00
	ETD125		1-1/4"		25	\$ 84.00
	ETD150		1-1/2"		25	\$ 120.50
	ETD200		2"		25	\$ 168.00
	ETD1000	1/2" - 2" Assorted Package includes: 8 x 1/2", 6 x 3/4", 4 x 1", 2 x 1 1/4", 2 x 1 1/2" 3 x 2"			25	\$ 25.20/bag
<b>Knockout Seals</b>						
	KOS-50		1/2"	500	50	\$ 123.25
	KOS-75		3/4"	500	50	\$ 140.25
	KOS-100		1"	250	25	\$ 208.25
	KOS-125		1-1/4"	10	-	\$ 250.75
	KOS-150		1-1/2"	10	-	\$ 318.76
	KOS-200		2"	10	-	\$ 531.26
	KOS-250		2-1/2"	10	-	\$ 956.27
	KOS-300		3"	1	-	\$ 1,126.27
	KOS-350		3-1/2"	1	-	\$ 1,168.77
	KOS-400		4"	1	-	\$ 1,695.78
	KOS-500		5"	1	-	\$ 5,525.09
	KOS-600		6"	1	-	\$ 6,157.03
<b>Knockout Seals - Vapour Tight (neoprene backing)</b>						
	KOS-50-VT		1/2"	500	50	\$ 701.26
	KOS-75-VT		3/4"	500	50	\$ 956.27
	KOS-100-VT		1"	250	25	\$ 1,253.77
	KOS-125-VT		1-1/4"	10	-	\$ 1,445.02
	KOS-150-VT		1-1/2"	10	-	\$ 1,678.78
	KOS-200-VT		2"	10	-	\$ 1,806.28
	KOS-250-VT		2-1/2"	10	-	\$ 2,273.79
	KOS-300-VT		3"	1	-	\$ 3,081.30
	KOS-350-VT		3-1/2"	1	-	\$ 3,931.31
	KOS-400-VT		4"	1	-	\$ 5,100.08
	KOS-500-VT		5"	1	-	\$ 5,950.10
	KOS-600-VT		6"	1	-	\$ 6,375.11

	Catalogue Number	Alternate Cat. No.	Size or Description	Packaging		List Price
				Case	Box	
<b>Steel Locknuts - cULus Listed</b>						
	LK-38	280	3/8"	2000	200	\$ 18.75
	LK-05	281	1/2"	2000	100	\$ 16.25
	LK-07	282	3/4"	1000	100	\$ 19.68
	LK-10	283	1"	1000	100	\$ 28.14
	LK-12	284	1-1/4"	500	50	\$ 48.39
	LK-15	285	1-1/2"	500	50	\$ 57.20
	LK-20	286	2"	250	25	\$ 78.94
	LK-25	287	2-1/2"	50	-	\$ 156.84
	LK-30	288	3"	50	-	\$ 186.13
	LK-35	289	3-1/2"	25	-	\$ 280.05
	LK-40	290	4"	25	-	\$ 292.06
	LK-50	290A	5"	10	-	\$ 4,255.91
	LK-60	290B	6"	10	-	\$ 7,207.09
<b>Bonding Lock-nuts</b> - Used in harsh vibration environments to fasten threaded conduit to an unthreaded opening in a box or enclosure.						
	121-S	551	1/2"	200	50	\$ 446.58
	122-S	552	3/4"	100	25	\$ 559.35
	123-S	553	1"	100	25	\$ 773.33
	124-S	554	1-1/4"	50	10	\$ 1,017.88
	125-S	555	1-1/2"	50	10	\$ 1,312.18
	126-S	556	2"	50	10	\$ 1,376.56
	127-S	557	2-1/2"	25	5	\$ 2,432.12
	128-S	558	3"	25	5	\$ 3,081.07
	129-S	559	3-1/2"	5	-	\$ 4,985.61
	130-S	560	4"	5	-	\$ 6,481.31
	131-S	-	5"	5	-	\$ 12,626.53
	132-S	-	6"	5	-	\$ 20,453.66
<b>Sealing Locknuts - Steel</b>						
	711		1/2"	500	50	\$ 134.19
	712		3/4"	500	50	\$ 156.84
	713		1"	250	25	\$ 232.23
	714		1-1/4"	100	10	\$ 363.68
	715		1-1/2"	100	10	\$ 475.79
	716		2"	100	10	\$ 640.64
	717		2-1/2"	25	-	\$ 831.90
	718		3"	25	-	\$ 2,372.32
	719		3-1/2"	25	-	\$ 2,880.59
	720		4"	25	-	\$ 3,278.81
<b>Sealing Rings</b>						
	SR-05	SR-050	1/2"	400	100	\$ 101.40
	SR-07	SR-075	3/4"	400	100	\$ 127.40
	SR-10	SR-100	1"	400	100	\$ 169.00
	SR-12	SR-125	1-1/4"	200	50	\$ 338.00
	SR-15	SR-150	1-1/2"	200	50	\$ 379.60
	SR-20	SR-200	2"	200	50	\$ 444.60
	SR-25	SR-250	2-1/2"	-	5	\$ 868.40
	SR-30	SR-300	3"	-	5	\$ 1,289.40
	SR-35	SR-350	3-1/2"	-	5	\$ 1,800.00
	SR-40	SR-400	4"	-	5	\$ 1,926.60



	Catalogue Number	Alternate Cat. No.	Size or Description	Packaging		List Price
				Case	Box	
<b>Plastic Insulator Bushings</b>						
	BUS-05	831	1/2"	2000	200	\$ 9.46
	BUS-07	832	3/4"	1000	100	\$ 12.27
	BUS-10	833	1"	500	50	\$ 24.96
	BUS-12	834	1-1/4"	250	25	\$ 29.33
	BUS-15	835	1-1/2"	250	25	\$ 34.42
	BUS-20	836	2"	500	50	\$ 59.70
	BUS-25	837	2-1/2"	-	20	\$ 83.82
	BUS-30	838	3"	-	10	\$ 123.55
	BUS-35	839	3-1/2"	-	10	\$ 175.45
	BUS-40	840	4"	-	10	\$ 210.70
	BUS-50	840A	5"	-	5	\$ 1,440.30
	BUS-60	840B	6"	-	5	\$ 2,725.32

**Lock-A-Liners**

- Used for converting ordinary bushing and connectors to code approved insulating bushings and connectors without disturber



191		1/2"	100	25	\$ 83.16
192		3/4"	100	25	\$ 90.09
193		1"	100	25	\$ 99.33
194		1-1/4"	40	10	\$ 159.39
195		1-1/2"	40	10	\$ 198.66
196		2"	40	10	\$ 228.69

**Rigid Bushing - Insulated - Zinc Die Cast**



311		1/2"	1000	100	\$ 204.10
312		3/4"	500	50	\$ 288.81
313		1"	500	50	\$ 429.00
314		1-1/4"	250	25	\$ 457.60
315		1-1/2"	250	25	\$ 550.33
316		2"	100	10	\$ 666.69
317		2-1/2"	50	-	\$ 1,545.92
318		3"	25	-	\$ 1,809.38
319		3-1/2"	25	-	\$ 2,543.46
320		4"	10	-	\$ 3,147.73

**Rigid Insulated Grounding Bushing - Zinc Die Cast**



321		1/2"	500	50	\$ 586.52
322		3/4"	500	50	\$ 612.73
323		1"	250	25	\$ 734.50
324		1-1/4"	200	20	\$ 820.52
325		1-1/2"	100	10	\$ 877.71
326		2"	100	10	\$ 1,119.52
327		2-1/2"	50	-	\$ 1,729.44
328		3"	10	-	\$ 3,142.31
329		3-1/2"	10	-	\$ 3,836.08
330		4"	10	-	\$ 3,960.23
330AM	Malleable Iron	5"	10	-	\$ 19,603.17
330BM	Malleable Iron	6"	10	-	\$ 25,730.88

Catalogue Number	Alternate Cat. No.	US Packaging			CDN Packaging		List Price	
		Size	Sling	Bundle	Sling	Bundle		
<b>Rigid Steel Conduit</b>		<b>Weight (lbs.) / 100'</b>						<b>per 100'</b>
RIG-05	79.0	1/2"	2500	100	1000	100	\$ 375.60	
RIG-07	105.0	3/4"	2000	50	1000	100	\$ 408.35	
RIG-10	153.0	1"	1250	50	500	100	\$ 609.50	
RIG-12	201.0	1-1/4"	900	-	250	50	\$ 887.64	
RIG-15	249.0	1-1/2"	800	-	250	50	\$ 1,008.84	
RIG-20	322.0	2"	600	-	200	50	\$ 1,351.26	
RIG-25	527.0	2-1/2"	370	-	100	-	\$ 2,389.26	
RIG-30	682.0	3"	300	-	100	-	\$ 3,218.16	
RIG-35	831.0	3-1/2"	250	-	100	-	\$ 4,638.75	
RIG-40	973.0	4"	200	-	100	-	\$ 4,780.19	
RIG-50	1,315.0	5"	150	-	10	-	\$ 11,109.06	
RIG-60	1,746.0	6"	100	-	10	-	\$ 16,096.45	



**Rigid 90° Elbow**



			Size - Radius				
9ELBR05	61	1/2"	radius = 4.000"	-	50	\$	1,465.85
9ELBR07	62	3/4"	radius = 4.500"	-	50	\$	1,825.20
9ELBR10	63	1"	radius = 5.750"	-	20	\$	2,743.48
9ELBR12	64	1-1/4"	radius = 7.250"	-	20	\$	4,454.60
9ELBR15	65	1-1/2"	radius = 8.250"	-	10	\$	5,369.09
9ELBR20	66	2"	radius = 9.500"	-	10	\$	8,618.29
9ELBR25	67	2-1/2"	radius = 10.500"	-	1	\$	18,014.21
9ELBR30	68	3"	radius = 13.000"	-	1	\$	25,600.14
9ELBR35	69	3-1/2"	radius = 15.000"	-	1	\$	34,654.02
9ELBR40	70	4"	radius = 16.000"	-	1	\$	40,299.08
9ELBR50		5"	radius = 24"	-	1	\$	102,903.69
9ELBR60		6"	radius = 30"	-	1	\$	154,828.89

**Rigid 45° Elbow**



			Size - Radius				
4ELBR05	11	1/2"	radius = 4.000"	-	50	\$	1,759.02
4ELBR07	12	3/4"	radius = 4.500"	-	50	\$	2,190.24
4ELBR10	13	1"	radius = 5.750"	-	35	\$	3,292.18
4ELBR12	14	1-1/4"	radius = 7.250"	-	30	\$	5,345.52
4ELBR15	15	1-1/2"	radius = 8.250"	-	15	\$	6,442.91
4ELBR20	16	2"	radius = 9.500"	-	15	\$	10,341.95
4ELBR25	17	2-1/2"	radius = 10.500"	-	1	\$	21,617.05
4ELBR30	18	3"	radius = 13.000"	-	1	\$	30,720.17
4ELBR35	19	3-1/2"	radius = 15.000"	-	1	\$	41,584.82
4ELBR40	20	4"	radius = 16.000"	-	1	\$	48,358.90
4ELBR50	19	5"	radius = 24"	-	1	\$	123,484.43
4ELBR60	20	6"	radius = 30"	-	1	\$	185,794.67

**Rigid 30° Elbow**



			Size - Radius				
3ELBR20		2"	radius = 9.500"	-	1	\$	10,341.95
3ELBR25		2-1/2"	radius = 10.500"	-	1	\$	21,617.05
3ELBR30		3"	radius = 13.000"	-	1	\$	30,720.17
3ELBR35		3-1/2"	radius = 15.000"	-	1	\$	41,584.82
3ELBR40		4"	radius = 16.000"	-	1	\$	48,358.90

Catalogue Number	Alternate Cat. No.	Size or Description	Case	Box	Packaging	List Price
------------------	--------------------	---------------------	------	-----	-----------	------------

**Large Radius Galvanized Elbows - Special Order - Call for Delivery Details**

Size	Radius (A)					Case	Box	List Price
	18"	24"	36"	48"	60"			
1"	9ELBR10-RADIUS					-	1	\$ P.O.R.
1-1/4"	9ELBR12-RADIUS					-	1	\$ P.O.R.
1-1/2"	9ELBR15-RADIUS					-	1	\$ P.O.R.
2"	9ELBR20-RADIUS					-	1	\$ P.O.R.
2-1/2"	9ELBR25-RADIUS					-	1	\$ P.O.R.
3"	9ELBR30-RADIUS					-	1	\$ P.O.R.
3-1/2"	9ELBR35-RADIUS					-	1	\$ P.O.R.
4"	9ELBR40-RADIUS					-	1	\$ P.O.R.
5"	9ELBR50-RADIUS					-	1	\$ P.O.R.
6"	9ELBR60-RADIUS					-	1	\$ P.O.R.

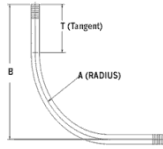

**Dimensions of Large Radius 90° Elbows**

Radius (A)	Tangent (T)	Offset (B)	Unbent Length
18"	10"	28"	48"
24"	11"	35"	59"
36"	11"	47"	78"
48"	12"	60"	100"
60"	12"	72"	118"

**Rigid Conduit Coupling**



RCP05		1/2"	-	100	\$	891.68
RCP07		3/4"	-	50	\$	1,093.20
RCP10		1"	-	30	\$	1,479.17
RCP12		1-1/4"	-	25	\$	1,821.37
RCP15		1-1/2"	-	25	\$	2,228.25
RCP20		2"	-	20	\$	3,106.61
RCP25		2-1/2"	-	12	\$	7,983.29
RCP30		3"	-	8	\$	11,848.50
RCP35		3-1/2"	-	4	\$	17,981.78
RCP40		4"	-	4	\$	18,193.24
RCP50		5"	-	2	\$	38,539.99
RCP60		6"	-	1	\$	44,145.97

**Steel Set Screw Coupling for Rigid Conduit**







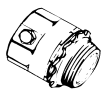



681S		1/2"	250	25	\$	754.00
682S		3/4"	250	25	\$	813.00
683S		1"	100	25	\$	1,107.00
684S		1-1/4"	50	5	\$	2,145.00
685S		1-1/2"	50	5	\$	2,317.00
686S		2"	20	-	\$	4,888.00
SCP-25	647S	2-1/2"	-	12	\$	2,070.99
SCP-30	648S	3"	-	10	\$	2,453.35
SCP-35	649S	3-1/2"	-	6	\$	2,314.52
SCP-40	650S	4"	-	10	\$	3,276.09
3610		5"	5	1	\$	86,538.38
3611		6"	-	1	\$	112,247.44

**Steel Set Screw Connector for Rigid Conduit**



671S		1/2"	250	25	\$	543.00
672S		3/4"	250	25	\$	696.00
673S		1"	100	25	\$	989.00
674S		1-1/4"	50	5	\$	1,706.00
675S		1-1/2"	50	5	\$	1,979.00
676S		2"	20	-	\$	3,239.00
SC-25	637S	2-1/2"	-	20	\$	2,958.06
SC-30	638S	3"	-	12	\$	3,545.06
SC-35	639S	3-1/2"	-	8	\$	3,772.00
SC-40	640S	4"	-	15	\$	4,679.71
3510		5"	5	1	\$	87,423.19
3511		6"	-	1	\$	110,508.75

	Catalogue Number	Alternate Cat. No.	Size or Description	Packaging		List Price
				Case	Box	
<b>Steel Compression Connectors for RIGID CONDUIT</b>						
	261		1/2"	200	20	\$ 484.63
	262		3/4"	100	10	\$ 805.90
	263		1	50	5	\$ 1,123.09
	264		1-1/4"	50	5	\$ 1,960.14
	265		1-1/2"	-	12	\$ 2,755.54
	266		2"	-	12	\$ 5,401.96
	RTSC-25	657S	2-1/2"	-	12	\$ 5,774.29
	RTSC-30	658S	3"	-	10	\$ 7,948.73
	RTSC-35	659S	3-1/2"	-	8	\$ 8,725.16
	RTSC-40	660S	4"	-	8	\$ 12,276.83
<b>Steel Compression Couplings for RIGID CONDUIT</b>						
	251		1/2"	100	10	\$ 774.63
	252		3/4"	100	10	\$ 1,475.33
	253		1	50	5	\$ 1,908.07
	254		1-1/4"	50	5	\$ 2,823.17
	255		1-1/2"	-	12	\$ 3,561.44
	256		2"	-	5	\$ 7,991.15
	RTSCP-25	667S	2-1/2"	-	16	\$ 7,091.80
	RTSCP-30	668S	3"	-	12	\$ 8,579.99
	RTSCP-35	669S	3-1/2"	-	8	\$ 9,748.48
	RTSCP-40	670S	4"	-	8	\$ 13,716.68
<b>3-Piece Coupling - Malleable Iron</b>						
	851		1/2"	200	20	\$ 479.68
	852		3/4"	100	10	\$ 600.37
	853		1"	50	5	\$ 1,146.63
	854		1-1/4"	50	5	\$ 1,645.41
	855		1-1/2"	30	3	\$ 2,162.16
	856		2"	-	20	\$ 3,440.47
	857		2-1/2"	-	10	\$ 11,739.84
	858		3"	-	5	\$ 15,160.40
	859		3-1/2"	-	5	\$ 23,301.80
	860		4"	-	2	\$ 27,791.87
	860A		5"	-	1	\$ 70,826.42
	860B		6"	-	1	\$ 92,242.55
<b>Rigid Conduit End Cap - Malleable Iron - Galvanised</b>						
	TRC-05		1/2"	-	50	\$ 287.000
	TRC-07		3/4"	-	40	\$ 381.000
	TRC-10		1"	-	25	\$ 430.000
	TRC-12		1-1/4"	-	20	\$ 492.000
	TRC-15		1-1/2"	-	18	\$ 574.000
	TRC-20		2"	-	12	\$ 820.000
	TRC-25		2-1/2"	-	28	\$ 1802.000
	TRC-30		3"	-	18	\$ 2523.000
	TRC-35		3-1/2"	-	7	\$ 4600.000
	TRC-40		4"	-	7	\$ 4507.000
	TRC-50		5"	-	8	\$ 9912.000
	TRC-60		6"	-	4	\$ 16654.000
<b>Rigid Threaded Plug - Square Head - Malleable Iron - Galvanised</b>						
	TRP-05		1/2"	-	50	\$ 376.00
	TRP-07		3/4"	-	40	\$ 456.00
	TRP-10		1"	-	25	\$ 644.00
	TRP-12		1-1/4"	-	20	\$ 940.00
	TRP-15		1-1/2"	-	18	\$ 1,234.00
	TRP-20		2"	-	12	\$ 1,718.00
	TRP-25		2-1/2"	-	28	\$ 3,840.00
	TRP-30		3"	-	18	\$ 5,316.00
	TRP-40		4"	-	7	\$ 8,858.00
	TRP-50		5"	-	8	\$ 25,300.00
	TRP-60		6"	-	4	\$ 35,200.00

	Catalogue Number	Alternate Cat. No.	Size or Description	Packaging		List Price
				Case	Box	
<b>Malleable Iron Split Rigid Coupling</b>						
	SRC-050		1/2"	200	20	\$ 2,574.00
	SRC-075		3/4"	100	10	\$ 2,986.50
	SRC-100		1	50	5	\$ 4,009.50
	SRC-125		1-1/4"	50	5	\$ 5,667.75
	SRC-150		1-1/2"	-	12	\$ 6,905.25
	SRC-200		2"	-	12	\$ 13,125.75
	SRC-250		2-1/2"	-	12	\$ 31,236.15
	SRC-300		3"	-	10	\$ 46,999.43
	SRC-350		3-1/2"	-	8	\$ 75,612.90
	SRC-400		4"	-	8	\$ 88,989.45
	SRC-500		5"	-	2	123,107.82
SRC-600	6"		-	1	150,440.40	
<b>Raintight 3-Piece Coupling</b>						
	1121-RT		1/2"	100	10	\$ 1,571.35
	1122-RT		3/4"	100	10	\$ 1,753.13
	1123-RT		1	50	5	\$ 3,093.75
	1124-RT		1-1/4"	50	5	\$ 4,125.00
	1125-RT		1-1/2"	-	12	\$ 5,981.25
	1126-RT		2"	-	5	\$ 9,548.00
	1127-RT		2-1/2"	-	16	\$ 21,617.75
	1128-RT		3"	-	12	\$ 29,337.00
	1129-RT		3-1/2"	-	8	\$ 46,299.00
	1130-RT		4"	-	8	\$ 53,996.25

**Malleable Iron:**

**Material Properties**

Malleable Iron product with exceptional elongation and deformation properties corrosion resistance, and shock absorption.  
Malleable Iron is also extremely impact resistant and durable.

**Product Categories**

Product for Rigid, EMT, Flexible Metal Conduit and Liquid

**Finish**

Zinc electroplated for enhanced corrosion resistance and extended life in areas that may be exposed to salt water and a variety of chemicals.

**Applications**

Used in applications requiring exceptional strength such as warehouses, outdoor buildings, bridges and airports.  
Also used in power distribution applications.

Catalogue Number	Alternate Cat. No.	Size or Description	Packaging		List Price
			Case	Box	
<b>Rigid Conduit Nipple - Zinc Plated</b>					
NP05000	6451	1/2" x Close	-	50	\$ 325.11
NP05015	6451112	1/2" x 1-1/2"	-	25	\$ 357.43
NP05020	64512	1/2" x 2"	-	25	\$ 376.44
NP05025	6451212	1/2" x 2-1/2"	-	25	\$ 425.89
NP05030	64513	1/2" x 3"	-	25	\$ 456.30
NP05035	6451312	1/2" x 3-1/2"	-	25	\$ 492.43
NP05040	64514	1/2" x 4"	-	25	\$ 543.76
NP05045		1/2" x 4-1/2"	-	25	\$ 478.95
NP05050	64515	1/2" x 5"	-	25	\$ 623.56
NP05060	64516	1/2" x 6"	-	25	\$ 724.33
NP05080	64518	1/2" x 8"	-	25	\$ 1,224.32
NP05100	645110	1/2" x 10"	-	25	\$ 1,439.15
NP05120	645112	1/2" x 12"	-	25	\$ 1,619.76
NP07000	6452	3/4" x Close	-	25	\$ 420.18
NP07015		3/4" x 1-1/2"	-	25	\$ 454.54
NP07020	64522	3/4" x 2"	-	25	\$ 471.52
NP07025	6452212	3/4" x 2-1/2"	-	25	\$ 515.24
NP07030	64523	3/4" x 3"	-	25	\$ 553.26
NP07035	6452312	3/4" x 3-1/2"	-	25	\$ 602.68
NP07040	64524	3/4" x 4"	-	25	\$ 657.83
NP07045		3/4" x 4-1/2"	-	25	\$ 516.03
NP07050	64525	3/4" x 5"	-	25	\$ 768.10
NP07060	64526	3/4" x 6"	-	25	\$ 895.48
NP07080	64528	3/4" x 8"	-	25	\$ 1,517.10
NP07100	645210	3/4" x 10"	-	25	\$ 1,781.45
NP07120	645212	3/4" x 12"	-	25	\$ 2,009.49
NP10000	6453	1" x Close	-	25	\$ 610.13
NP10020	64532	1" x 2"	-	25	\$ 652.14
NP10025	6453212	1" x 2-1/2"	-	25	\$ 768.10
NP10030	64533	1" x 3"	-	25	\$ 834.64
NP10035	6453312	1" x 3-1/2"	-	25	\$ 895.48
NP10040	64534	1" x 4"	-	25	\$ 969.63
NP10045		1" x 4-1/2"	-	25	\$ 1,081.81
NP10050	64535	1" x 5"	-	25	\$ 1,121.73
NP10060	64536	1" x 6"	-	25	\$ 1,254.81
NP10080	64538	1" x 8"	-	25	\$ 2,127.36
NP10100	645310	1" x 10"	-	25	\$ 2,382.11
NP10120	645312	1" x 12"	-	25	\$ 2,815.56
NP12000	6454	1-1/4" x Close	-	25	\$ 798.52
NP12020	64542	1-1/4" x 2"	-	25	\$ 912.58
NP12025	6454212	1-1/4" x 2-1/2"	-	25	\$ 969.63
NP12030	64543	1-1/4" x 3"	-	25	\$ 1,036.17
NP12035	6454312	1-1/4" x 3-1/2"	-	25	\$ 1,136.95
NP12040	64544	1-1/4" x 4"	-	25	\$ 1,230.10
NP12050	64545	1-1/4" x 5"	-	25	\$ 1,410.72
NP12060	64546	1-1/4" x 6"	-	25	\$ 1,598.95
NP12080	64548	1-1/4" x 8"	-	25	\$ 2,714.80
NP12100	645410	1-1/4" x 10"	-	25	\$ 3,193.89
NP12120	645412	1-1/4" x 12"	-	25	\$ 2,920.05



**Custom lengths, longer threads, various paint options and a fast turn around time are all available on made to order conduit nipples**

NOTE: Custom conduit nipples are non-returnable.

**Call or fax your requirements for quote.**

**Custom lengths, longer threads, various paint options and a fast turn around time are all available on made to order conduit nipples**  
 NOTE: Custom conduit nipples are non-returnable.  
**Call or fax your requirements for quote.**

	Catalogue Number	Alternate Cat. No.	Size or Description		Packaging			List Price
					Case	Box		
<b>Rigid Conduit Nipple - Zinc Plated</b>								
	NP15000	6455	1-1/2"	x	Close	-	25	\$ 958.22
	NP15020	64552	1-1/2"	x	2"	-	25	\$ 1,173.06
	NP15025	6455212	1-1/2"	x	2-1/2"	-	25	\$ 1,228.19
	NP15030	64553	1-1/2"	x	3"	-	25	\$ 1,264.32
	NP15035	6455312	1-1/2"	x	3-1/2"	-	25	\$ 1,351.78
	NP15040	64554	1-1/2"	x	4"	-	25	\$ 1,488.66
	NP15050	64555	1-1/2"	x	5"	-	25	\$ 1,718.72
	NP15060	64556	1-1/2"	x	6"	-	25	\$ 1,920.25
	NP15080	64558	1-1/2"	x	8"	-	25	\$ 3,133.04
	NP15100	645510	1-1/2"	x	10"	-	25	\$ 3,690.42
	NP15120	645512	1-1/2"	x	12"	-	25	\$ 4,148.25
	NP20000	6456	2"	x	Close	-	25	\$ 1,197.78
	NP20025	6456212	2"	x	2-1/2"	-	25	\$ 1,452.55
	NP20030	64563	2"	x	3"	-	25	\$ 1,574.22
	NP20035	6456312	2"	x	3-1/2"	-	25	\$ 1,754.83
	NP20040	64564	2"	x	4"	-	25	\$ 1,905.04
	NP20050	64565	2"	x	5"	-	25	\$ 2,190.22
	NP20060	64566	2"	x	6"	-	25	\$ 2,494.42
	NP20080	64568	2"	x	8"	-	25	\$ 4,403.00
	NP20100	645610	2"	x	10"	-	25	\$ 5,180.55
	NP20120	645612	2"	x	12"	-	25	\$ 5,825.04
	NP25000	6457	2-1/2"	x	Close	-	25	\$ 2,829.04
	NP25030	64573	2-1/2"	x	3"	-	10	\$ 3,041.97
	NP25035	6457312	2-1/2"	x	3-1/2"	-	10	\$ 3,464.05
	NP25040	64574	2-1/2"	x	4"	-	10	\$ 3,958.37
	NP25050	64575	2-1/2"	x	5"	-	10	\$ 4,519.23
	NP25060	64576	2-1/2"	x	6"	-	10	\$ 4,985.04
	NP25080	64578	2-1/2"	x	8"	-	10	\$ 7,248.99
	NP25100	645710	2-1/2"	x	10"	-	10	\$ 8,283.19
	NP25120	645712	2-1/2"	x	12"	-	10	\$ 8,710.94
	NP30000	6458	3"	x	Close	-	10	\$ 3,695.11
	NP30030	64583	3"	x	3"	-	10	\$ 3,952.67
	NP30035	6458312	3"	x	3-1/2"	-	10	\$ 4,260.66
	NP30040	64584	3"	x	4"	-	10	\$ 4,557.27
	NP30050	64585	3"	x	5"	-	10	\$ 5,156.15
	NP30060	64586	3"	x	6"	-	10	\$ 5,791.16
	NP30080	64588	3"	x	8"	-	5	\$ 7,992.32
	NP30100	645810	3"	x	10"	-	5	\$ 9,627.28
	NP30120	645812	3"	x	12"	-	5	\$ 10,530.32
	NP35000	6459	3-1/2"	x	Close	-	10	\$ 4,859.70
	NP35040	64594	3-1/2"	x	4"	-	6	\$ 5,840.53
	NP35050	64595	3-1/2"	x	5"	-	6	\$ 6,680.98
	NP35060	64596	3-1/2"	x	6"	-	6	\$ 7,697.34
	NP35080	64598	3-1/2"	x	8"	-	3	\$ 11,978.97
	NP35100	645910	3-1/2"	x	10"	-	3	\$ 13,691.88
	NP35120	645912	3-1/2"	x	12"	-	3	\$ 14,977.04
	NP40000	6410	4"	x	Close	-	10	\$ 5,080.04
	NP40040	64104	4"	x	4"	-	6	\$ 6,661.42
	NP40050	64105	4"	x	5"	-	4	\$ 7,633.36
	NP40060	64106	4"	x	6"	-	4	\$ 8,820.32
	NP40080	64108	4"	x	8"	-	4	\$ 13,729.91
	NP40100	641010	4"	x	10"	-	4	\$ 15,689.97
	NP40120	641012	4"	x	12"	-	4	\$ 17,161.43
	NP50000		5"	x	Close	-	1	\$ 15,122.81
	NP50050		5"	x	5"	-	1	\$ 19,945.20
	NP50060		5"	x	6"	-	1	\$ 22,416.80
	NP50100		5"	x	10"	-	1	\$ 33,977.64
	NP50120		5"	x	12"	-	1	\$ 37,165.02
	NP60000		6"	x	Close	-	1	\$ 20,197.51
	NP60050		6"	x	5"	-	1	\$ 26,617.29
	NP60060		6"	x	6"	-	1	\$ 29,815.63
	NP60100		6"	x	10"	-	1	\$ 45,192.80
	NP60120		6"	x	12"	-	1	\$ 49,432.28



**Custom lengths, longer threads, various paint options and a fast turn around time are all available on made to order conduit nipples**





NOTE: Custom conduit nipples are non-returnable.

**Call or fax your requirements for quote.**







**NE12-LIST**

Effective Date: August 1, 2010



	Catalogue Number	Alternate Cat. No.	Size or Description	Packaging		List Price
				Case	Box	
<b>Chase Nipples - Zinc Die Cast</b>						
	751	1102-DC	1/2"	1000	100	\$ 98.58
	751A	1791-DC	1/2" x 1" Long	-	100	\$ 229.40
	752	1103-DC	3/4"	500	50	\$ 220.35
	752A	1792-DC	3/4" x 1" Long	-	50	\$ 295.83
	753	1104-DC	1"	250	25	\$ 282.96
	754	1105-DC	1-1/4"	250	25	\$ 555.96
	755	1106-DC	1-1/2"	100	25	\$ 653.69
	756	1107-DC	2"	40	10	\$ 1,051.27
	757	1108-DC	2-1/2"	40	10	\$ 1,360.02
	758	1109-DC	3"	40	10	\$ 1,772.54
	759	1110-DC	3-1/2"	40	40	\$ 2,202.21
	760	1111-DC	4"	20	5	\$ 2,942.54
<b>Malleable Iron -</b>	1112		5"	5	-	\$ 9,298.08
<b>Malleable Iron -</b>	1113		6"	5	-	\$ 12,455.52
<b>Chase Nipples - Zinc Die Cast - Insulated Throat</b>						
	751i	1102-DCI	1/2"	1000	100	\$ 151.88
	752i	1103-DCI	3/4"	500	50	\$ 266.71
	753i	1104-DCI	1"	250	25	\$ 426.63
	754i	1105-DCI	1-1/4"	250	25	\$ 744.69
	755i	1106-DCI	1-1/2"	100	25	\$ 943.79
	756i	1107-DCI	2"	40	10	\$ 1,432.17
	757i	1108-DCI	2-1/2"	40	10	\$ 4,292.81
	758i	1109-DCI	3"	40	10	\$ 6,249.75
	759i	1110-DCI	3-1/2"	40	10	\$ 12,830.13
	760i	1111-DCI	4"	20	5	\$ 21,117.85
<b>1-hole Rigid Conduit Strap - Steel - Snap on Type</b>						
	531		1/2"	500	50	\$ 19.22
	532		3/4"	500	50	\$ 22.20
	533		1"	250	25	\$ 44.15
	534		1-1/4"	200	20	\$ 59.03
	535		1-1/2"	200	20	\$ 76.54
	536		2"	100	10	\$ 123.66
	517		2-1/2"	25	-	\$ 191.90
	518		3"	25	-	\$ 267.30
	519		3-1/2"	25	-	\$ 402.30
	520		4"	25	-	\$ 410.30
<b>2-hole Rigid Conduit Strap - Steel - Snap on 1/2" - 2"</b>						
	541		1/2"	500	50	\$ 14.07
	542		3/4"	500	50	\$ 17.50
	543		1"	250	25	\$ 25.40
	544		1-1/4"	200	20	\$ 33.75
	545		1-1/2"	100	10	\$ 45.08
	546		2"	50	-	\$ 61.78
	527		2-1/2"	25	-	\$ 132.94
	528		3"	25	-	\$ 164.27
	529		3-1/2"	25	-	\$ 220.11
	530		4"	25	-	\$ 300.87
	530A		5"	10	-	\$ 3,066.00
	530B		6"	10	-	\$ 3,809.40
<b>Offset Conduit Nipple - Zinc Die Cast</b>						
	111	1520-DC	1/2"	200	20	\$ 348.63
	112	1521-DC	3/4"	100	10	\$ 449.58
	113	1522-DC	1"	50	5	\$ 637.44
	114	1523-DC	1-1/4"	40	10	\$ 1,128.83
	115	1524-DC	1-1/2"	40	10	\$ 1,345.50
	116	1525-DC	2"	30	5	\$ 2,125.29
	117	1526-DC	2-1/2"	2	-	\$ 15,765.42
	118	1527-DC	3"	2	-	\$ 18,768.33

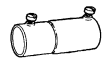

	Catalogue Number	Alternate Cat. No.	Size or Description	Packaging		List Price
				Case	Box	
<b>Rigid Watertight Hub - Zinc Die Cast</b>						
	201	151-DC	1/2"	250	25	\$ 1,953.85
	202	152-DC	3/4"	100	10	\$ 2,287.50
	203	153-DC	1"	100	10	\$ 2,739.58
	204	154-DC	1-1/4"	20	2	\$ 3,516.98
	205	155-DC	1-1/2"	20	2	\$ 3,906.46
	206	156-DC	2"	20	2	\$ 5,070.58
	207	157-DC	2-1/2"	2	-	\$ 10,055.35
	208	158-DC	3"	2	-	\$ 13,672.63
	209	159-DC	3-1/2"	1	-	\$ 17,909.21
	210	160-DC	4"	1	-	\$ 23,894.79
<b>Rigid to Box Pull Elbow - Zinc Die Cast</b>						
	361	71-DC2	1/2"	100	10	\$ 783.75
	362	72-DC2	3/4"	50	5	\$ 1,284.40
	363		1"	-	25	\$ 2,695.15
	364		1-1/4"	-	20	\$ 3,194.02
<b>Rigid to Rigid Pull Elbow - Zinc Die Cast</b>						
	351	81-DC	1/2"	100	10	\$ 818.03
	352	82-DC	3/4"	50	5	\$ 1,385.10
	353	83-DC	1"	-	25	\$ 2,928.85
	354	84-DC	1-1/4"	-	20	\$ 3,471.30
<b>COMBINATION TYPE - Rigid OR EMT to Box (Threaded for Rigid - Set-Screw for EMT)</b>						
	71-DCA		1/2"	100	10	\$ 825.00
	72-DCA		3/4"	50	5	\$ 1,352.00
<b>COMBINATION TYPE - Rigid to Rigid OR EMT to EMT Threaded for Rigid - Set-Screw for EMT)</b>						
	81-DCA		1/2"	100	10	\$ 861.08
	82-DCA		3/4"	50	5	\$ 1,458.00
	83-DCA		1"	-	25	\$ 3,083.00
	84-DCA		1-1/4"	-	20	\$ 3,654.00
<b>Rigid to EMT Set Screw Coupling - Steel</b>						
	391S		1/2" x 1/2"	250	25	\$ 177.11
	392S		3/4" x 3/4"	100	10	\$ 266.66
	393S		1" x 1"	100	10	\$ 390.73
<b>Clamps - Malleable Iron</b>						
	561		1/2"	1000	100	\$ 46.00
	562		3/4"	500	50	\$ 58.00
	563		1"	250	25	\$ 70.00
	564		1-1/4"	200	20	\$ 162.00
	565		1-1/2"	100	10	\$ 215.00
	566		2"	25	-	\$ 473.00
	567		2-1/2"	25	-	\$ 693.00
	568		3"	25	-	\$ 993.00
	569		3-1/2"	10	-	\$ 1,629.00
	570		4"	10	-	\$ 3,051.00
<b>EMT / Rigid Clamp Backs</b>						
	481		1/2"	250	25	\$ 95.00
	482		3/4"	250	25	\$ 120.00
	483		1"	250	25	\$ 162.00
	484		1-1/4"	100	10	\$ 192.00
	485		1-1/2"	100	10	\$ 230.00
	486		2"	50	5	\$ 483.00
	487		2-1/2"	25	-	\$ 1,003.00
	488		3"	10	-	\$ 1,374.00
	489		3-1/2"	10	-	\$ 1,810.00
	489A		4"	10	-	\$ 2,524.00

Catalogue Number	Alternate Cat. No.	Size or Description	Packaging		List Price
			Case	Box	
<b>Rigid Reducer Bushings</b>					
RB0538	RB1	1/2" x 3/8"	1000	100	\$ 96.00
RB0705	RB2	3/4" x 1/2"	1000	100	\$ 82.60
RB1005	RB3	1" x 1/2"	250	50	\$ 126.75
RB1007	RB4	1" x 3/4"	250	50	\$ 126.75
RB1205	RB5	1-1/4" x 1/2"	250	25	\$ 267.81
RB1207	RB6	1-1/4" x 3/4"	250	25	\$ 267.81
RB1210	RB7	1-1/4" x 1"	250	25	\$ 267.81
	RB1505	1-1/2" x 1/2"	250	25	\$ 416.53
	RB1507	1-1/2" x 3/4"	250	25	\$ 416.53
	RB1510	1-1/2" x 1"	250	25	\$ 416.53
	RB1512	1-1/2" x 1-1/4"	250	25	\$ 416.53
	RB2005	2" x 1/2"	-	10	\$ 587.33
	RB2007	2" x 3/4"	-	10	\$ 587.33
	RB2010	2" x 1"	-	10	\$ 587.33
	RB2012	2" x 1-1/4"	-	10	\$ 587.33
	RB2015	2" x 1-1/2"	-	10	\$ 587.33
	RB2510	2-1/2" x 1"	-	10	\$ 2,180.80
	RB2512	2-1/2" x 1-1/4"	-	10	\$ 2,180.80
	RB2515	2-1/2" x 1-1/2"	-	10	\$ 2,180.80
	RB2520	2-1/2" x 2"	-	10	\$ 1,677.60
	RB3012	3" x 1-1/4"	-	10	\$ 3,548.00
	RB3015	3" x 1-1/2"	-	10	\$ 3,548.00
	RB3020	3" x 2"	-	10	\$ 2,710.70
	RB3025	3" x 2-1/2"	-	10	\$ 2,170.70
	RB3515	3-1/2" x 1-1/2"	-	10	\$ 6,571.20
	RB3520	3-1/2" x 2"	-	10	\$ 6,571.20
	RB3525	3-1/2" x 2-1/2"	-	10	\$ 6,571.20
	RB3530	3-1/2" x 3"	-	10	\$ 6,571.20
	RB4020	4" x 2"	-	10	\$ 7,620.70
	RB4025	4" x 2-1/2"	-	10	\$ 7,620.70
	RB4030	4" x 3"	-	10	\$ 7,620.70
	RB4035	4" x 3-1/2"	-	10	\$ 7,620.70

**Rigid Male Enlargers - Zinc Die Cast**



981	1/2"M x 3/4"F	250	25	\$ 761.52
982	3/4"M x 1"F	100	10	\$ 945.75
983	1"M x 1-1/4"F	100	10	\$ 1,188.33

**Rigid Floor Flange - Malleable Iron - Galvanized**



291	1/2"	-	50	\$ 560.67
292	3/4"	-	50	\$ 629.09
293	1"	-	50	\$ 876.07
294	1-1/4"	-	25	\$ 1,062.44
295	1-1/2"	-	25	\$ 1,405.75
296	2"	-	25	\$ 1,826.63

Catalogue Number	Alternate Cat. No.	Size or Description	Packaging		List Price
			Case	Box	
<b>Reducing Washers - Steel</b>					
RW0705	900	3/4" x 1/2"	1000	100	\$ 9.38
RW1005	901	1" x 1/2"	1000	100	\$ 11.10
RW1007	902	1" x 3/4"	1000	100	\$ 11.10
RW1205	903	1-1/4" x 1/2"	500	50	\$ 20.48
RW1207	904	1-1/4" x 3/4"	500	50	\$ 20.48
RW1210	905	1-1/4" x 1"	500	50	\$ 20.48
	RW1505	1-1/2" x 1/2"	500	50	\$ 38.79
	RW1507	1-1/2" x 3/4"	500	50	\$ 38.79
	RW1510	1-1/2" x 1"	500	50	\$ 38.79
	RW1512	1-1/2" x 1-1/4"	500	50	\$ 38.79
RW2005	910	2" x 1/2"	250	25	\$ 45.99
RW2007	911	2" x 3/4"	250	25	\$ 45.99
RW2010	912	2" x 1"	250	25	\$ 45.99
RW2012	913	2" x 1-1/4"	250	25	\$ 45.99
RW2015	914	2" x 1-1/2"	250	25	\$ 45.99
RW2505	915	2-1/2" x 1/2"	250	25	\$ 109.48
RW2507	916	2-1/2" x 3/4"	250	25	\$ 109.48
RW2510	917	2-1/2" x 1"	250	25	\$ 109.48
RW2512	918	2-1/2" x 1-1/4"	250	25	\$ 109.48
RW2515	919	2-1/2" x 1-1/2"	250	25	\$ 109.48
RW2520	920	2-1/2" x 2"	250	25	\$ 109.48
RW3005	921	3" x 1/2"	25	-	\$ 253.74
RW3007	922	3" x 3/4"	25	-	\$ 253.74
RW3010	923	3" x 1"	25	-	\$ 253.74
RW3012	924	3" x 1-1/4"	25	-	\$ 253.74
RW3015	925	3" x 1-1/2"	25	-	\$ 253.74
RW3020	926	3" x 2"	25	-	\$ 253.74
RW3025	927	3" x 2-1/2"	25	-	\$ 253.74
RW3505	928	3-1/2" x 1/2"	10	-	\$ 638.60
RW3507	929	3-1/2" x 3/4"	10	-	\$ 638.60
RW3510	930	3-1/2" x 1"	10	-	\$ 638.60
RW3512	931	3-1/2" x 1-1/4"	10	-	\$ 638.60
RW3515	932	3-1/2" x 1-1/2"	10	-	\$ 638.60
RW3520	933	3-1/2" x 2"	10	-	\$ 638.60
RW3525	934	3-1/2" x 2-1/2"	10	-	\$ 638.60
RW3530	935	3-1/2" x 3"	10	-	\$ 638.60
RW4005	936	4" x 1/2"	10	-	\$ 1,450.00
RW4007	937	4" x 3/4"	10	-	\$ 1,450.00
RW4010	938	4" x 1"	10	-	\$ 1,450.00
RW4012	939	4" x 1-1/4"	10	-	\$ 1,450.00
RW4015	940	4" x 1-1/2"	10	-	\$ 1,450.00
RW4020	941	4" x 2"	10	-	\$ 1,450.00
RW4025	942	4" x 2-1/2"	10	-	\$ 1,450.00
RW4030	943	4" x 3"	10	-	\$ 1,450.00
RW4035	944	4" x 3-1/2"	10	-	\$ 1,450.00

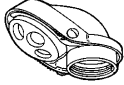

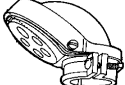

Catalogue Number	Alternate Cat. No.	Size or Description	Packaging		List Price
			Case	Box	
<b>Service Entrance Caps - Threaded Type - Aluminum</b>					
	741	1/2"	50	5	\$ 1,203.54
	742	3/4"	50	5	\$ 1,342.50
	743	1"	-	50	\$ 2,031.46
	744	1-1/4"	-	20	\$ 2,440.42
	745	1-1/2"	-	10	\$ 3,965.42
	746	2"	-	5	\$ 8,069.38
	747	2-1/2"	-	2	\$ 20,685.00
	748	3"	-	1	\$ 33,413.96
	749	3-1/2"	-	1	\$ 34,252.29
	750	4"	-	1	\$ 58,470.42
	750A	5"	-	1	\$ 118,181.54
	750B	6"	-	1	\$ 156,611.52





<b>Service Entrance Caps - Clamp On - Aluminum</b>					
	731	1/2"	50	10	\$ 1,203.54
	732	3/4"	50	10	\$ 1,342.50
	733	1"	25	5	\$ 2,031.46
	734	1-1/4"	25	5	\$ 2,440.42
	735	1-1/2"	15	3	\$ 3,965.42
	736	2"	-	5	\$ 8,069.38
	737	2-1/2"	-	1	\$ 20,685.00
	738	3"	-	1	\$ 33,413.96
	739	3-1/2"	-	1	\$ 34,252.29
	740	4"	-	1	\$ 58,470.42

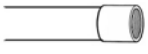

<b>Roof Flange - Galvanized with Neoprene Seal</b>					
	984	1-1/4"	10		\$ 19.20
	985	1-1/2"	10		\$ 12.80
	986	2"	10		\$ 13.20
	987	2-1/2" - 3"	10		\$ 28.76

**Mast Kits**

	MK-10020	100 Amp or Less Service - For Rigid/IMC Conduit - Clamp Type Entrance Cap Cat. #1256 - Roof Flashing RF-200 - Porcelain Wire Holder MWH-1 - 2" Pipe Strap 1906 (Two)	\$	5,260.01
	MK-20025	For 125,150, or 200 Amp Service - For Rigid/IMC Conduit - Slip-Fit Screw Type Entrance Cap Cat. # 1257-MT - Roof Flashing RF-250 - Porcelain Wire Holder MWH-1 - Conduit Support	\$	7,304.21
	MK-20025R	For 125,150, or 200 Amp Service - For Rigid/IMC Conduit - Slip-Fit Screw Type Entrance Cap # 1257-MT - Roof Flashing RF-250 - Porcelain Wire Holder MWH-1 - Conduit Support (Two) - Bottom Reducer	\$	10,467.65

	Catalogue Number	Alternate Cat. No.	Size or Description	Case	Packaging Box	List Price
<b>Device boxes - Malleable Iron - Zinc Plated</b>						
<b>Single Gang FS Box</b>						
	FS50		1/2"	-	8	2,574.00
	FS75		3/4"	-	8	2,745.00
	FS100		1"	-	8	3,042.00
<b>Single Gang FS Box - Deep</b>						
	FD50		1/2"	-	8	2,939.00
	FD75		3/4"	-	8	3,205.00
	FD100		1"	-	8	3,566.00
<b>Single Gang FSC Box</b>						
	FSC50		1/2"	-	8	2,932.00
	FSC75		3/4"	-	8	3,216.00
	FSC100		1"	-	8	3,937.00
<b>Single Gang FSC Box - Deep</b>						
	FDC50		1/2"	-	8	3,342.00
	FDC75		3/4"	-	8	3,763.00
	FDC100		1"	-	8	4,606.00
<b>Cast Device Box Cover - Blank</b>						
	FSFDCM1			-	8	1,166.00
<b>Cast Device Box Cover - Dual Outlet</b>						
	FSFDCM3			-	8	1,166.00
<b>Cast Device Box Cover - Switch Plate</b>						
	FSFDCM2			-	8	1,408.00
<b>GASKET for FS &amp; FD Cast Box</b>						
	FSFDCG			-	8	242.00

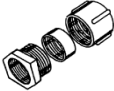
Catalogue Number	Alternate Cat. No.	Size or Description	Packaging		List Price	
			Case	Box		
<b>Rigid Aluminum Conduit - coupling one end</b>						
per 100'						
Weight (lbs.) / 100'						
	CA-05	28.0	1/2"	1000	100	\$ 298.95
	CA-07	38.0	3/4"	1000	50	\$ 382.00
	CA-10	56.0	1"	500	50	\$ 566.20
	CA-12	76.0	1-1/4"	250	50	\$ 756.45
	CA-15	92.0	1-1/2"	250	50	\$ 913.47
	CA-20	125.0	2"	200	50	\$ 1,223.00
	CA-25	195.0	2-1/2"	100	-	\$ 2,154.59
	CA-30	265.0	3"	100	-	\$ 2,818.94
	CA-35	315.0	3-1/2"	100	-	\$ 3,617.67
	CA-40	375.0	4"	100	-	\$ 4,297.12
	CA-50	509.0	5"	80	-	\$ 5,839.17
	CA-60	680.0	6"	60	-	\$ 7,784.80
<b>Rigid Aluminum 90° Elbow</b>						
	9ELBA05		1/2"	-	50	\$ 850.84
	9ELBA07		3/4"	-	40	\$ 993.76
	9ELBA10		1"	-	25	\$ 1,607.51
	9ELBA12		1-1/4"	-	20	\$ 2,570.99
	9ELBA15		1-1/2"	-	15	\$ 3,231.82
	9ELBA20		2"	-	10	\$ 5,801.14
	9ELBA25		2-1/2"	-	1	\$ 11,666.17
	9ELBA30		3"	-	1	\$ 14,943.38
	9ELBA35		3-1/2"	-	1	\$ 20,724.36
	9ELBA40		4"	-	1	\$ 26,525.49
	9ELBA50		5"	-	1	\$ 78,430.67
	9ELBA60		6"	-	1	\$ 108,515.28
<b>Rigid Aluminum 45° Elbow</b>						
	4ELBA05		1/2"	-	50	\$ 1,021.01
	4ELBA07		3/4"	-	40	\$ 1,192.51
	4ELBA10		1"	-	25	\$ 1,929.01
	4ELBA12		1-1/4"	-	20	\$ 3,085.19
	4ELBA15		1-1/2"	-	15	\$ 3,878.18
	4ELBA20		2"	-	10	\$ 6,961.37
	4ELBA25		2-1/2"	-	1	\$ 13,999.40
	4ELBA30		3"	-	1	\$ 17,932.06
	4ELBA35		3-1/2"	-	1	\$ 24,869.23
	4ELBA40		4"	-	1	\$ 31,830.59
	9ELBA50		5"	-	1	\$ 94,116.80
	9ELBA60		6"	-	1	\$ 130,218.34
<b>Rigid Aluminum Coupling</b>						
	ACP05		1/2"	-	100	\$ 511.18
	ACP07		3/4"	-	50	\$ 633.92
	ACP10		1"	-	25	\$ 803.76
	ACP12		1-1/4"	-	25	\$ 983.67
	ACP15		1-1/2"	-	25	\$ 1,341.84
	ACP20		2"	-	15	\$ 1,664.67
	ACP25		2-1/2"	-	8	\$ 3,608.48
	ACP30		3"	-	6	\$ 5,649.81
	ACP35		3-1/2"	-	6	\$ 6,312.31
	ACP40		4"	-	5	\$ 9,145.62
	ACP50		5"	-	1	\$ 30,882.02
	ACP60		6"	-	1	\$ 48,200.66

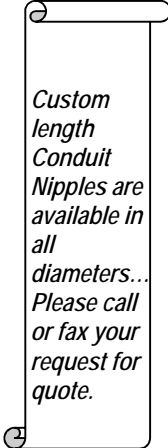
	Catalogue Number	Alternate Cat. No.	Size or Description	Packaging		List Price
				Case	Box	
<b>Aluminum Lock Nuts</b>						
	ALK-05		1/2"	2000	100	\$ 52.67
	ALK-07		3/4"	1000	100	\$ 80.31
	ALK-10		1"	1000	100	\$ 136.94
	ALK-12		1-1/4"	500	50	\$ 186.97
	ALK-15		1-1/2"	500	50	\$ 289.68
	ALK-20		2"	250	25	\$ 402.91
	ALK-25		2-1/2"	50	-	\$ 922.90
	ALK-30		3"	50	-	\$ 1,156.42
	ALK-35		3-1/2"	25	-	\$ 2,197.57
	ALK-40		4"	25	-	\$ 2,750.58
	ALK-50		5"	10	-	\$
ALK-60		6"	10	-	\$	
<b>3-Piece Coupling - Aluminum</b>						
	851AL	1121-AL	1/2"	200	20	\$ 1,368.74
	852AL	1122-AL	3/4"	100	10	\$ 1,605.38
	853AL	1123-AL	1"	50	5	\$ 5,739.20
	854AL	1124-AL	1-1/4"	50	5	\$ 8,983.48
	855AL	1125-AL	1-1/2"	30	3	\$ 12,747.96
	856AL	1126-AL	2"	-	20	\$ 16,628.04
	857AL	1127-AL	2-1/2"	-	10	\$ 30,640.46
	858AL	1128-AL	3"	-	5	\$ 48,859.70
	859AL	1129-AL	3-1/2"	-	5	\$ 84,101.38
	860AL	1130-AL	4"	-	2	\$ 92,488.50
<b>1-hole Rigid Conduit Strap - Aluminum</b>						
	531AL		1/2"	1000	100	\$ 119.00
	532AL		3/4"	-	100	\$ 149.00
	533AL		1"	-	100	\$ 236.00
	534AL		1-1/4"	-	50	\$ 411.00
	535AL		1-1/2"	-	50	\$ 486.00
	536AL		2"	-	25	\$ 882.00
<b>Rigid Aluminum Conduit Nipple</b>						
   <i>Custom length Conduit Nipples are available in all diameters... Please call or fax your request for quote.</i>	ANP05000		1/2" x Close	-	25	\$ 179.93
	ANP05015		1/2" x 1-1/2"	-	25	\$ 198.42
	ANP05020		1/2" x 2"	-	25	\$ 235.40
	ANP05025		1/2" x 2-1/2"	-	25	\$ 264.00
	ANP05030		1/2" x 3"	-	25	\$ 292.58
	ANP05040		1/2" x 4"	-	25	\$ 359.83
	ANP05050		1/2" x 5"	-	25	\$ 425.43
	ANP05060		1/2" x 6"	-	25	\$ 491.00
	ANP07000		3/4" x Close	-	25	\$ 235.40
	ANP07020		3/4" x 2"	-	25	\$ 292.58
	ANP07025		3/4" x 2-1/2"	-	25	\$ 339.65
	ANP07030		3/4" x 3"	-	25	\$ 378.34
	ANP07040		3/4" x 4"	-	25	\$ 472.51
	ANP07050		3/4" x 5"	-	25	\$ 558.25
	ANP07060		3/4" x 6"	-	25	\$ 642.32
	ANP10000		1" x Close	-	25	\$ 359.83
	ANP10020		1" x 2"	-	25	\$ 482.58
	ANP10025		1" x 2-1/2"	-	25	\$ 491.00
	ANP10030		1" x 3"	-	25	\$ 558.25
	ANP10040		1" x 4"	-	25	\$ 672.60
	ANP10050		1" x 5"	-	25	\$ 822.25
ANP10060		1" x 6"	-	25	\$ 953.39	

Catalogue Number	Alternate Cat. No.	Size or Description	Packaging		List Price
			Case	Box	
<b>Rigid Aluminum Conduit Nipple</b>					
	ANP12000	1-1/4" x Close	-	25	\$ 491.00
	ANP12020	1-1/4" x 2"	-	25	\$ 548.17
	ANP12025	1-1/4" x 2-1/2"	-	25	\$ 642.32
	ANP12030	1-1/4" x 3"	-	25	\$ 717.99
	ANP12040	1-1/4" x 4"	-	25	\$ 906.32
	ANP12050	1-1/4" x 5"	-	25	\$ 1,086.24
	ANP12060	1-1/4" x 6"	-	25	\$ 1,247.66
	ANP15000	1-1/2" x Close	-	25	\$ 642.32
	ANP15020	1-1/2" x 2"	-	25	\$ 699.52
	ANP15025	1-1/2" x 2-1/2"	-	25	\$ 813.83
ANP15030	1-1/2" x 3"	-	25	\$ 916.41	
ANP15040	1-1/2" x 4"	-	25	\$ 1,153.51	
ANP15050	1-1/2" x 5"	-	25	\$ 1,380.51	
ANP15060	1-1/2" x 6"	-	25	\$ 1,587.32	
ANP20000	2" x Close	-	25	\$ 850.84	
ANP20025	2" x 2-1/2"	-	25	\$ 992.07	
ANP20030	2" x 3"	-	25	\$ 1,141.72	
ANP20040	2" x 4"	-	25	\$ 1,435.99	
ANP20050	2" x 5"	-	25	\$ 1,889.99	
ANP20060	2" x 6"	-	25	\$ 1,984.16	
ANP25000	2-1/2" x Close	-	1	\$ 2,644.98	
ANP25030	2-1/2" x 3"	-	1	\$ 2,890.48	
ANP25040	2-1/2" x 4"	-	1	\$ 3,391.56	
ANP25050	2-1/2" x 5"	-	1	\$ 3,778.30	
ANP25060	2-1/2" x 6"	-	1	\$ 4,269.30	
ANP30000	3" x Close	-	1	\$ 3,647.15	
ANP30030	3" x 3"	-	1	\$ 3,901.05	
ANP30040	3" x 4"	-	1	\$ 4,553.47	
ANP30050	3" x 5"	-	1	\$ 5,062.97	
ANP30060	3" x 6"	-	1	\$ 5,725.47	
ANP40000	4" x Close	-	1	\$ 5,289.96	
ANP40040	4" x 4"	-	1	\$ 6,744.46	
ANP40050	4" x 5"	-	1	\$ 7,462.45	
ANP40060	4" x 6"	-	1	\$ 8,370.46	

**Custom lengths, longer threads, various paint options and a fast turn around time are all available on made to order conduit nipples**  
 NOTE: Custom conduit nipples are non-returnable.  
**Call or fax your requirements for quote.**



Catalogue Number	Alternate Cat. No.	Size or Description	Packaging		List Price	
			Reel	Coil		
<b>Metallic Liquid Tight Conduit - CSA - Black</b>						
	38LT30	3/8"	-	30	\$ 13,557.00	
	38LT150	3/8"	150	-	\$ 13,557.00	
	38LT300	3/8"	300	-	\$ 13,557.00	
	05LT30	1/2"	-	30	\$ 16,185.00	
	05LT150	1/2"	150	-	\$ 16,185.00	
	05LT300	1/2"	300	-	\$ 16,185.00	
	07LT30	3/4"	-	30	\$ 22,371.00	
	07LT150	3/4"	150	-	\$ 22,371.00	
	07LT300	3/4"	300	-	\$ 22,371.00	
	10LT30	1"	-	30	\$ 29,897.00	
	10LT150	1"	150	-	\$ 29,897.00	
	12LT15	1-1/4"	-	15	\$ 38,711.00	
	12LT75	1-1/4"	75	-	\$ 38,711.00	
	15LT15	1-1/2"	-	15	\$ 49,691.00	
	15LT75	1-1/2"	75	-	\$ 49,691.00	
	20LT15	2"	-	15	\$ 68,557.00	
	20LT30	2"	30	-	\$ 68,557.00	
	25LT08	*	2-1/2"	-	8	\$ 116,804.00
	30LT08	*	3"	-	8	\$ 172,629.00
	40LT08	*	4"	-	8	\$ 340,000.00

\*\*\* Please note: for 2-1/2" to 4" conduit, a charge of (+) 25% applies to orders less than standard coil length. \*\*\*

**Metallic LT Conduit - Computer Blue - Integral Copper Ground**

Catalogue Number	Alternate Cat. No.	Size or Description	Packaging		List Price
			Reel	Coil	
	38CBLT30	3/8"	-	30	\$ 23,600.00
	38CBLT150	3/8"	150	-	\$ 23,600.00
	38CBLT300	3/8"	300	-	\$ 23,600.00
	05CBLT30	1/2"	-	30	\$ 28,151.00
	05CLBT150	1/2"	150	-	\$ 28,151.00
	05CBLT300	1/2"	300	-	\$ 28,151.00
	07CBLT30	3/4"	-	30	\$ 39,250.00
	07CBLT150	3/4"	150	-	\$ 39,250.00
	10CBLT30	1"	-	30	\$ 53,950.00
	10CBLT150	1"	150	-	\$ 53,950.00

**Metallic LT Conduit - Dual Listed - UL/CSA - Integral Copper Ground**

Catalogue Number	Alternate Cat. No.	Size or Description	Packaging		List Price
			Reel	Coil	
	38ULLT30	3/8"	-	30	\$ 14,527.12
	05ULLT30	1/2"	-	30	\$ 18,377.84
	07ULLT30	3/4"	-	30	\$ 24,580.32
	10ULLT30	1"	-	30	\$ 36,322.72
	12ULLT15	1 1/4"	-	15	\$ 47,851.92
	15ULLT15	1 1/2"	-	15	\$ 60,617.68
	20ULLT15	2"	-	15	\$ 74,977.52

Catalogue Number	Alternate Cat. No.	Size or Description	Packaging			
			Reel	Coil		
<b>Metallic LT Conduit -Extra Flex -Grey</b>						
38EFLT30		3/8"	-	30	\$	12,460.72
05EFLT30		1/2"	-	30	\$	13,900.64
	05EFLT300	1/2"	300 -	(reel)	\$	13,900.64
07EFLT30		3/4"	-	30	\$	18,722.24
07EFLT150		3/4"	150 -	(reel)	\$	18,722.24
10EFLT30		1"	-	30	\$	29,365.84
12EFLT15		1-1/4"	-	15	\$	38,825.36
15EFLT15		1-1/2"	-	15	\$	55,792.80
20EFLT15		2"	-	15	\$	67,817.28



Catalogue Number	Alternate Cat. No.	Size or Description	Packaging			List Price
			Case	Box		
<b>Liquid Tight Connector - Zinc Die Cast</b>						
470	429-LT2	3/8"	200	20	\$	478.19
471	430-LT2	1/2"	200	20	\$	438.96
472	431-LT2	3/4"	100	10	\$	585.88
473	432-LT2	1"	50	5	\$	1,222.00
474	433-LT2	1-1/4"	50	5	\$	1,979.46
475	434-LT2	1-1/2"	20	2	\$	2,934.96
476	435-LT2	2"	20	2	\$	4,676.96
477	436-LT2	2-1/2"	-	1	\$	19,336.21
478	437-LT2	3"	-	1	\$	20,995.44
479	438-LT2	3-1/2"	-	1	\$	24,662.50
480	439-LT2	4"	-	1	\$	26,799.50



<b>90° Liquid Tight Connector - Zinc Die Cast</b>						
490	469-LT2	3/8"	100	10	\$	940.84
491	470-LT2	1/2"	100	10	\$	940.84
492	471-LT2	3/4"	100	10	\$	1,379.96
493	472-LT2	1"	50	5	\$	2,216.30
494	473-LT2	1-1/4"	20	2	\$	3,485.38
495	474-LT2	1-1/2"	20	2	\$	5,134.36
496	475-LT2	2"	10	1	\$	7,415.67
497	476-LT2	2-1/2"	-	1	\$	34,183.42
498	477-LT2	3"	-	1	\$	39,853.02
499	478-LT2	3-1/2"	-	1	\$	49,879.21
500	479-LT2	4"	-	1	\$	53,241.07







<b>Liquid Tight Connector, Insulated Throat - Zinc Die Cast</b>						
470i	429-LTI2	3/8"	200	20	\$	666.04
471i	430-LTI2	1/2"	200	20	\$	627.90
472i	431-LTI2	3/4"	100	10	\$	958.31
473i	432-LTI2	1"	50	5	\$	1,408.13
474i	433-LTI2	1-1/4"	50	5	\$	2,358.42
475i	434-LTI2	1-1/2"	20	2	\$	3,421.60
476i	435-LTI2	2"	20	2	\$	5,237.27

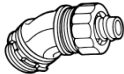

<b>90° Liquid Tight Connector Insulated Throat - Zinc Die Cast</b>						
490i	469-LTI2	3/8"	100	10	\$	1,064.73
491i	470-LTI2	1/2"	100	10	\$	1,064.73
492i	471-LTI2	3/4"	100	10	\$	1,481.64
493i	472-LTI2	1"	50	5	\$	2,305.56
494i	473-LTI2	1-1/4"	20	2	\$	4,064.09
495i	474-LTI2	1-1/2"	20	2	\$	5,429.49
496i	475-LTI2	2"	10	1	\$	8,206.53



Catalogue Number	Alternate Cat. No.	Size or Description	Packaging		List Price
			Case	Box	
<b>Liquid Tight Connector, Insulated Throat - Malleable Iron</b>					
	470S	3/8"	250	25	\$ 602.52
	471S	1/2"	200	20	\$ 553.09
	472S	3/4"	100	10	\$ 738.20
	473S	1"	50	5	\$ 1,539.72
	474S	1-1/4"	50	5	\$ 2,494.12
	475S	1-1/2"	20	2	\$ 3,698.05
	476S	2"	20	2	\$ 5,892.97
	477S	2-1/2"	-	1	\$ 24,363.62
	478S	3"	-	1	\$ 26,454.25
	479S	3-1/2"	-	1	\$ 31,074.75
	480S	4"	-	1	\$ 33,767.37
<b>45° Liquid Tight Connector, Insulated Throat - Malleable Iron</b>					
	230S	3/8"	100	10	\$ 962.10
	231S	1/2"	100	10	\$ 913.90
	232S	3/4"	100	10	\$ 1,087.20
	233S	1"	50	5	\$ 1,702.40
	234S	1-1/4"	20	2	\$ 4,261.50
	235S	1-1/2"	20	2	\$ 5,461.50
	236S	2"	20	2	\$ 7,210.64
	237S	2-1/2"	-	1	\$ 17,330.72
	238S	3"	-	1	\$ 26,645.88
	240S	4"	-	1	\$ 30,739.54
<b>90° Liquid Tight Connector, Insulated Throat - Malleable Iron</b>					
	490S	3/8"	100	10	\$ 1,034.93
	491S	1/2"	100	10	\$ 1,034.93
	492S	3/4"	100	10	\$ 1,517.95
	493S	1"	50	5	\$ 2,437.75
	494S	1-1/4"	20	2	\$ 3,833.92
	495S	1-1/2"	20	2	\$ 5,647.79
	496S	2"	20	1	\$ 8,157.23
	497S	2-1/2"	-	1	\$ 37,601.76
	498S	3"	-	1	\$ 43,838.32
	500S	4"	-	1	\$ 54,867.13
<b>Liquid Tight Connector - STEEL - PLATED</b>					
	429-SLT	3/8"	100	25	\$ 632.74
	430-SLT	1/2"	100	25	\$ 596.50
	431-SLT	3/4"	50	10	\$ 910.40
	432-SLT	1"	25	5	\$ 1,337.72
	433-SLT	1-1/4"	20	5	\$ 2,240.50
	434-SLT	1-1/2"	10	2	\$ 3,250.52
	435-SLT	2"	20	2	\$ 4,975.41
<b>90° Liquid Tight Connector -STEEL - PLATED</b>					
	469-SLT	3/8"	100	25	\$ 1,011.50
	470-SLT	1/2"	100	25	\$ 1,011.50
	471-SLT	3/4"	50	10	\$ 1,407.56
	472-SLT	1"	25	5	\$ 2,190.28
	473-SLT	1-1/4"	25	5	\$ 3,860.88
	474-SLT	1-1/2"	10	2	\$ 5,158.01
	475-SLT	2"	5	-	\$ 7,796.21
<b>Combination Liquid Tight to Raintight EMT Connector -ZDC</b>					
	4360-DC	1/2" Liquid Tight to 1/2" EMT	100	25	\$ 853.44
	4361-DC	3/4" Liquid Tight to 3/4" EMT	50	50	\$ 1,221.30



Catalogue Number	Alternate Cat. No.	Size or Description	Packaging Case	Box	List Price
------------------	--------------------	---------------------	----------------	-----	------------

**ACD-1**



60 AMP RATED A/C DISCONNECT PULL-OUT TYPE NON-FUSED	6	\$	24.00
---	---	----	-------

**ACD52**



60 AMP RATED A/C DISCONNECT PULL-OUT TYPE NON-FUSED With 15 AMP GFCI Recp.	6	\$	87.20
---	---	----	-------









**PRE-WIRED AIR CONDITIONER WHIPS**



ACW-6	6 FT. PRE-WIRED* A/C KIT 2 x 1/2" STRAIGHT, 1 x 1/2" 90°	\$	21.00
ACW-8	8 FT. PRE-WIRED* A/C KIT 1 x 1/2" STRAIGHT, 1 x 1/2" 90°	\$	23.90
ACW-6C	6 FT. A/C KIT - <i>NO WIRES</i> 2 x 1/2" STRAIGHT, 1 x 1/2" 90°	\$	16.00

\* Prewired: 1 x #10 Str. Black Wire  
1 x #10 Str. Red Wire  
1 x #12 Str. Green Wire

\*\*\*Custom Sizes also available Call for Quote\*\*\*

	Catalogue Number	Alternate Cat. No.	Size or Description	Packaging		List Price
				Reel	Coil	
<b>Non-metallic Liquid Tight Conduit - Grey</b>						
	15004	HF138	3/8"	-	100'	\$ 95.60
	15005	HF112	1/2"	-	100'	\$ 103.10
	15007	HF134	3/4"	-	100'	\$ 145.10
	15008	HF11	1"	-	100'	\$ 206.20
	15009	HF1114	1-1/4"	-	100'	\$ 341.60
	15010	HF1112	1-1/2"	-	50'	\$ 515.60
	15011	HF12	2"	-	50'	\$ 631.90
<b>Non-metallic Liquid Tight Conduit -ExtraFlex -Black</b>						
	15104	HF238	3/8"	-	100'	\$ 168.00
	15105	HF212	1/2"	-	100'	\$ 183.30
	15107	HF234	3/4"	-	100'	\$ 252.00
	15108	HF21	1"	-	100'	\$ 368.60
	15109		1-1/4"	-	100'	\$ 481.10
	15110		1-1/2"	-	50'	\$ 943.10
	15111		2"	-	50'	\$ 1,302.00
<b>Plastic Liquid Tight Connector - Screw in type</b>						
	SLT-05		1/2"		100	\$ 114.95
	SLT-07		3/4"		50	\$ 163.35
<b>90° Plastic Liquid Tight Connector - Screw in type</b>						
	SLT9-05		1/2"		100	\$ 151.00
	SLT9-07		3/4"		50	\$ 205.70
<b>Plastic Liquid Tight Connector - Component Type</b>						
	P470		3/8"	100	25	\$ 210.19
	P471		1/2"	100	25	\$ 192.94
	P472		3/4"	100	10	\$ 257.46
	P473		1"	50	5	\$ 537.13
	P474		1-1/4"	50	5	\$ 870.02
	P475		1-1/2"	20	5	\$ 1,290.04
	P476		2"	20	2	\$ 2,055.80
<b>90° Plastic Liquid Tight Connector - Component type</b>						
	P490		3/8"	100	25	\$ 292.76
	P491		1/2"	100	25	\$ 276.00
	P492		3/4"	100	10	\$ 421.22
	P493		1"	50	5	\$ 618.95
	P494		1-1/4"	20	5	\$ 1,036.59
	P495		1-1/2"	20	5	\$ 1,503.95
	P496		2"	10	2	\$ 2,302.06
<b>BLACK - Plastic Liquid Tight Connector - Component Type</b>						
	P470B	BLACK	3/8"	100	25	\$ 252.23
	P471B	BLACK	1/2"	100	25	\$ 231.53
	P472B	BLACK	3/4"	100	10	\$ 308.95
	P473B	BLACK	1"	50	5	\$ 644.56
	P474B	BLACK	1-1/4"	50	5	\$ 1,000.52
	P475B	BLACK	1-1/2"	50	5	\$ 1,483.55
	P476B	BLACK	2"	20	2	\$ 2,364.17
<b>BLACK - 90° Plastic Liquid Tight Connector - Component type</b>						
	P490B	BLACK	3/8"	100	10	\$ 351.31
	P491B	BLACK	1/2"	100	10	\$ 331.20
	P492B	BLACK	3/4"	100	10	\$ 505.46
	P493B	BLACK	1"	50	5	\$ 742.74
	P494B	BLACK	1-1/4"	20	2	\$ 1192.08
	P495B	BLACK	1-1/2"	20	2	\$ 1729.54
	P496B	BLACK	2"	10	1	\$ 2647.37

Catalogue Number	Size or Description	Packaging		List Price
		Case	Box	

**Multi-Angle Nonmetallic Liquid Tight Connector (Straight - 90°)**

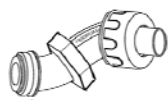

8618	Gray	1/2"	100	10	\$	412.00
8620	Gray	3/4"	100	10	\$	470.00



**BLACK - Nylon (6/6) - NPT Locknuts**



NLN38B	BLACK	3/8"	1000	100	\$	72.50
NLN12B	BLACK	1/2"	1000	100	\$	#REF!
NLN34B	BLACK	3/4"	500	50	\$	#REF!
NLN1B	BLACK	1"	200	50	\$	#REF!

**GRAY - Nylon (6/6) - NPT Locknuts**



NLN38G	GRAY	3/8"	1000	100	\$	#REF!
NLN12G	GRAY	1/2"	1000	100	\$	#REF!
NLN34G	GRAY	3/4"	500	50	\$	#REF!
NLN1G	GRAY	1"	200	50	\$	#REF!



**Liquid Tight Cord Grips**

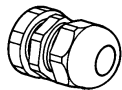

	Size	Cable Dia.				
LTF38	3/8"	.19" to .31"	100	25	\$	265.51
RLTF38	3/8"	.08" to .23"	100	25	\$	265.51
LTF12	1/2"	.27" to .48"	100	25	\$	315.64
LTF34	3/4"	.55" to .70"	100	10	\$	509.08
RLTF34	3/4"	.36" to .63"	100	10	\$	509.08
LTF1	1"	.71" to 1.0"	100	10	\$	831.07

**Liquid Tight Cord Grips - Flex NPT Hubs**



	Size	Cable Dia.				
FLEXLTF38	3/8"	.19" to .31"	100	25	\$	335.09
FLEXRLTF38	3/8"	.08" to .23"	100	25	\$	335.09
FLEXLTF12	1/2"	.27" to .48"	100	25	\$	406.33
FLEXRLTF12	1/2"	.20" to .35"	100	25	\$	406.33
FLEXLTF34	3/4"	.55" to .70"	100	10	\$	563.47
FLEXRLTF34	3/4"	.36" to .63"	100	10	\$	563.47

**Liquid Tight Cord Grips - PG Hubs**

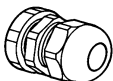

	Size	Cable Dia.				
LTF7	PG7	.09" to .26"	100	25	\$	292.06
LTF9	PG9	.20" to .30"	100	25	\$	298.69
LTF11	PG11	.23" to .39"	100	25	\$	318.66
LTF13	PG13	.27" to .48"	100	25	\$	509.08
LTF16	PG16	.43" to .55"	100	10	\$	509.08
LTF21	PG21	.55" to .70"	100	10	\$	558.25
LTF29	PG29	.70" to 1.0"	100	10	\$	844.27

**Liquid Tight Cord Grips - Flex PG Hubs**



	Size	Cable Dia.				
FLEXLTF7	PG7	.09" to .26"	100	25	\$	375.20
FLEXLTF9	PG9	.20" to .30"	100	25	\$	360.20
FLEXLTF11	PG11	.23" to .39"	100	25	\$	416.33
FLEXLTF13	PG13	.27" to .48"	100	25	\$	416.33
FLEXLTF16	PG16	.43" to .55"	100	10	\$	563.47
FLEXLTF21	PG21	.55" to .70"	100	10	\$	1,185.62

**NE12-LIST**

Effective Date: August 1, 2010



Product Specification Chart for Steel and Aluminum Portable Cord Grips. Pricing & Packaging on next page.

Steel Part #	Alum. Part #	Size	Min	Max	For Types S,SO,ST,STO	For Types SJ,SJIT,SJTO,SVO, Bus Drop	Color
CG770-250	CGA770250	½"	.150	.250		18-2,3,SVO	RED
CG770-350	CGA770350	½"	.250	.350		18-2,3 SJT 18-2,3,4 SJO 16-2,3, SJO	WHITE
CG770-450	CGA770450	½"	.350	.450	18-2,3,4 16-2,3,4	16-4 SJO 14-2,3,4 SJO 16-2,3,SJO	BLUE
CG770-560	CGA770560	½"	.450	.560	18-5,6,7 16-5,6 14-2,3	12-3 SJO 12-3 & 10-3 BUS DROP	GREEN
CG770-650	CGA770650	½"	.550	.650	18-8,10 16-7,8 14-4 12-2,3 10-2		BEIGE
CG771-250	CGA771250	¾"	.150	.250		18-2 & SVO	RED
CG-771-350	CGA771350	¾"	.250	.350		18-2,3 SJT 18-2,3,4 SJO 16-2,3 SJO	WHITE
CG771-450	CGA771450	¾"	.350	.450	18-2,3,4 16-2,3,4	16-4 SJO 14-2,3,4 SJO 12-2 SJO 14-3 BUS DROP	BLUE
CG771-560	CGA771560	¾"	.450	.560	18-5,6,7 16-5,6 14-2,3	12-3 SJO 12-3 & 10-3 BUS DROP	GREEN
CG771-650	CGA771650	¾"	.560	.650	18-8,10 16-7,8 14-4 12-2,3 10-2		BEIGE
CG771-750	CGA771750	¾"	.650	.750	18-12,14 16-10,12 14-5,6,7 12-4,5 10-3,4 8-2	8-3 BUS DROP	YELLOW
CG771-850	CGA771850	¾"	.750	.850	18-16,18,20 16-14,16,18 14-8 12-6,7,8 10-5 8-3,4 6-2	6-3 BUS DROP	PURPLE
CG772-560	CA772560	1"	.450	.560	18-5,6,7 16-5,6 14-2,3	12-3 SJO 12-3 & 10-3 BUS DROP	GREEN
CG772-650	CGA772650	1"	.550	.650	18-8,10 16-7,8 14-4 12-2,3 10-2		BEIGE
CG772-750	CGA772750	1"	.650	.750	18-2,14 16-10,12 14-5,6,7 12-4,5 10-3,4 8-2	8-3 BUS DROP	YELLOW
CG772-850	CGA772850	1"	.750	.850	18-16,18,20 16-14,16,18 14-8 12- 6,7,8 10-5 8-3,4 6-2	6-3 BUS DROP	PURPLE
CG772-950	CGA772950	1"	.850	.950	18-22,24,26 16-20,22,24 14-10,12 10-6,7,8 6-3,4	4-3 BUS DROP	GRAY
CG772-1050	CGA7721050	1"	.950	1.050	15-30 16-26 14-14.16 12-10 4-3		BLACK

Catalogue Number	Grommet Colour	Size - Min - Max	Packaging		List Price
			Case	Box	
<b>Portable Cord Grips - STEEL</b>					
CG770-250	RED	½" 0.15 0.25	250	25	\$ 511.21
CG770-350	WHITE	½" 0.25 0.35	250	25	\$ 511.21
CG770-450	BLUE	½" 0.35 0.45	250	25	\$ 511.21
CG770-560	GREEN	½" 0.45 0.56	250	25	\$ 511.21
CG770-650	BEIGE	½" 0.55 0.65	250	25	\$ 511.21
CG771-250	RED	¾" 0.15 0.25	100	10	\$ 630.73
CG771-350	WHITE	¾" 0.25 0.35	1000	10	\$ 630.73
CG771-450	BLUE	¾" 0.35 0.45	100	10	\$ 630.73
CG771-560	GREEN	¾" 0.45 0.56	100	10	\$ 630.73
CG771-650	BEIGE	¾" 0.56 0.65	100	10	\$ 630.73
CG771-750	YELLOW	¾" 0.65 0.75	100	10	\$ 827.14
CG771-850	PURPLE	¾" 0.75 0.85	50	5	\$ 827.14
CG772-560	GREEN	1" 0.45 0.56	50	5	\$ 1,072.08
CG772-650	BEIGE	1" 0.55 0.65	50	5	\$ 1,072.08
CG772-750	YELLOW	1" 0.65 0.75	50	5	\$ 1,072.08
CG772-850	PURPLE	1" 0.75 0.85	50	5	\$ 1,072.08
CG772-950	GRAY	1" 0.85 0.95	50	5	\$ 1,220.64
CG772-1050	BLACK	1" 0.95 1.05	50	5	\$ 1,220.64



**Portable Cord Grips - ALUMINUM**

CGA770-250	RED	½" 0.15 0.25	250	25	\$ 637.99
CGA770-350	WHITE	½" 0.25 0.35	250	25	\$ 637.99
CGA770-450	BLUE	½" 0.35 0.45	250	25	\$ 637.99
CGA770-560	GREEN	½" 0.45 0.56	250	25	\$ 637.99
CGA770-650	BEIGE	½" 0.55 0.65	250	25	\$ 637.99
CGA771-250	RED	¾" 0.15 0.25	100	10	\$ 782.01
CGA771-350	WHITE	¾" 0.25 0.35	1000	10	\$ 782.01
CGA771-450	BLUE	¾" 0.35 0.45	100	10	\$ 782.01
CGA771-560	GREEN	¾" 0.45 0.56	100	10	\$ 782.01
CGA771-650	BEIGE	¾" 0.56 0.65	100	10	\$ 782.01
CGA771-750	YELLOW	¾" 0.65 0.75	100	10	\$ 1,015.38
CGA771-850	PURPLE	¾" 0.75 0.85	50	5	\$ 1,015.38
CGA772-560	GREEN	1" 0.45 0.56	50	5	\$ 1,339.25
CGA772-650	BEIGE	1" 0.55 0.65	50	5	\$ 1,339.25
CGA772-750	YELLOW	1" 0.65 0.75	50	5	\$ 1,339.25
CGA772-850	PURPLE	1" 0.75 0.85	50	5	\$ 1,339.25
CGA772-950	GRAY	1" 0.85 0.95	50	5	\$ 1,543.60
CGA772-1050	BLACK	1" 0.95 1.05	50	5	\$ 1,543.60



Each cord grip fitting is identified by a color coded grommet that clearly indicates the minimum-maximum cable diameter range for which the connector can be used. Our cord grips 105°C rated neoprene sealing grommet grip the cable jacket firmly and safely.

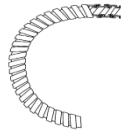

	Catalogue Number	Alternate Cat. No.	Size or Description	Packaging		List Price
				Reel	Coil	
<b>Flexible Aluminum Conduit</b>						
	516ALF75		5/16"	-	75	\$ 7,442.00
	38ALF75		3/8"	-	75	\$ 7,825.00
	38ALF150		3/8"	150	-	\$ 7,825.00
	38ALF300		3/8"	300	-	\$ 7,825.00
	716ALF75		7/16"	-	75	\$ 8,198.00
	716ALF150		7/16"	150	-	\$ 8,198.00
	716ALF300		7/16"	300	-	\$ 8,198.00
	05ALF30		1/2"	-	30	\$ 17,269.00
	05ALF150		1/2"	150	-	\$ 17,269.00
	05ALF300		1/2"	300	-	\$ 17,269.00
	07ALF30		3/4"	-	30	\$ 20,155.00
	07ALF150		3/4"	150	-	\$ 20,155.00
	07ALF300		3/4"	300	-	\$ 20,155.00
	10ALF30		1"	-	30	\$ 35,156.00
	10ALF150		1"	150	-	\$ 35,156.00
	10ALF300		1"	300	-	\$ 35,156.00
	12ALF15		1-1/4"	-	15	\$ 41,649.00
	12ALF75		1-1/4"	75	-	\$ 41,649.00
	15ALF15		1-1/2"	-	15	\$ 50,051.00
	15ALF75		1-1/2"	75	-	\$ 50,051.00
	20ALF15		2"	-	15	\$ 67,216.00
	20ALF75		2"	75	-	\$ 67,216.00
	25ALF08	*	2-1/2"	-	8	\$ 85,155.00
	25ALF15	*	2-1/2"	-	15	\$ 85,155.00
	30ALF08	*	3"	-	8	\$ 109,279.00
	30ALF15	*	3"	-	15	\$ 109,279.00
	35ALF	*	3-1/2"	-	15	\$ 187,113.00
	40ALF08	*	4"	-	8	\$ 249,484.00
	40ALF15	*	4"	-	15	\$ 249,484.00

\*\*\* Please note: for 2-1/2" to 4" conduit, a charge of (+) 25% applies to orders less than standard coil length. \*\*\*

**Anti-Short Bushings**

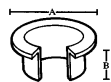







	Trade Size		Cable Size				
	<i>Packed in Poly Bags</i>						
	ASB-0	0	14/2, 14/3, 12/2	500 bags	35 / bag	\$	9.20/bag
	ASB-1	1	14/4, 12/3, 6/1, 4/1	400 bags	35 / bag	\$	13.02/bag
	ASB-2	2	12/4, 10/2, 10/3, 2/1	300 bags	35 / bag	\$	12.70/bag
	ASB-3	3	10/4, 8/2, 8/3, 1/1	200 bags	20 / bag	\$	12.06/bag
	ASB-4	4	8/4, 6/2, 6/3, 4/2, 4/3, 6/4	150 bags	16 / bag	\$	43.00/bag
	ASB-5 (1005)	5	1" MC/AC	100/case	25 / box	\$	48.00/box
	ASB-6 (1006)	6	1 1/4" MC/AC	40/case	10 / box	\$	17.80/box
	ASB-7 (1007)	7	1 1/2" MC/AC	40/case	10 / box	\$	18.00/box
	ASB-8 (1008)	8	2"-2 1/2" MC/AC	40/case	10 / box	\$	21.80/box





Cat. #	A	B
ASB-0	.550	.595
ASB-1	.675	.480
ASB-2	.845	.610
ASB-3	1.015	.680
ASB-4	1.340	.775

**NE12-LIST**

Effective Date: August 1, 2010



Catalogue Number	Alternate Cat. No.	Size or Description	Packaging		List Price	
			Case	Box		
<b>Flex Connector - Zinc Die Cast</b>						
	Range					
	545-DC2	A/C - M/C min: .410" max: .610"	3/8"	1000	100	\$ 139.75
<b>Flex Connector - Zinc Die Cast</b>						
	150	403-DC2	3/8"	500	50	\$ 139.75
	151	407-DC2	1/2"	250	25	\$ 276.25
	152	408-DC2	3/4"	250	25	\$ 360.54
	153	410-DC2	1"	100	10	\$ 607.31
	154	412-DC2	1-1/4"	100	10	\$ 1,162.85
	155	414-DC2	1-1/2"	50	5	\$ 1,669.85
	156	416-DC2	2"	40	10	\$ 2,058.33
	157	417-DC2	2-1/2"	-	10	\$ 5,621.42
	158	418-DC2	3"	-	10	\$ 7,846.58
	159	419-DC2	3-1/2"	-	1	\$ 13,041.67
	160	420-DC2	4"	-	1	\$ 14,778.40
	<b>Flex Connector - Insulated Throat - Zinc Die Cast</b>					
	151i		1/2"	250	25	\$ 209.63
	152i		3/4"	250	25	\$ 414.38
	153i		1"	100	10	\$ 540.81
	154i		1-1/4"	100	10	\$ 910.97
	155i		1-1/2"	50	5	\$ 1,744.28
	156i		2"	40	10	\$ 2,504.78
	157i		2-1/2"	-	1	\$ 3,087.50
	158i		3"	-	1	\$ 8,432.13
	159i		3-1/2"	-	1	\$ 11,769.88
	160i		4"	-	1	\$ 19,562.50
<b>Flex Connector - Zinc Die Cast</b>						
	Range					
	802-DC2	A/C - M/C min: .480" max: .580"	3/8" single screw	250	25	\$ 185.00
<b>90° Flex Connector - Zinc Die Cast</b>						
	100	801-DC2	3/8"	500	50	\$ 180.04
	101	804-DC2	1/2"	250	25	\$ 324.56
	102	806-DC2	3/4"	100	10	\$ 526.29
	103	807-DC2	1"	50	5	\$ 1,293.06
	104	808-DC2	1-1/4"	40	10	\$ 1,536.38
	105	809-DC2	1-1/2"	-	5	\$ 3,805.96
	106	810-DC2	2"	-	5	\$ 4,064.88
	107	811-DC2	2-1/2"	-	5	\$ 21,210.15
	108	812-DC2	3"	-	2	\$ 28,093.88
	109	813-DC2	3-1/2"	-	1	\$ 52,533.33
	110	814-DC2	4"	-	1	\$ 59,711.88
	<b>90° Flex Connector - Insulated Throat - Zinc Die Cast</b>					
	101i		1/2"	250	25	\$ 589.79
	102i		3/4"	100	10	\$ 881.25
	103i		1"	50	5	\$ 1,536.25
	104i		1-1/4"	40	10	\$ 3,074.17
	105i		1-1/2"	-	5	\$ 5,924.38
	106i		2"	-	5	\$ 7,811.67
	107i		2-1/2"	-	5	\$ 25,240.83
	108i		3"	-	2	\$ 46,938.75
	109i		3-1/2"	-	1	\$ 100,537.08
	110i		4"	-	1	\$ 116,654.38

	Catalogue Number	Alternate Cat. No.	Size or Description	Packaging		List Price
				Case	Box	
<b>Flex Connector - Malleable Iron</b>						
	151M		1/2"	250	25	\$ 134.16
	152M		3/4"	250	25	\$ 265.20
	153M		1"	100	10	\$ 346.12
	154M		1-1/4"	100	10	\$ 583.02
	155M		1-1/2"	50	5	\$ 1,116.34
	156M		2"	-	20	\$ 1,603.06
	157M		2-1/2"	-	10	\$ 4,182.33
	158M		3"	-	2	\$ 5,837.86
	159M		3-1/2"	-	1	\$ 9,703.00
	160M		4"	-	1	\$ 10,995.13
<b>Flex Connector - Insulated Throat - Malleable Iron</b>						
	151Mi		1/2"	250	25	\$ 160.99
	152Mi		3/4"	250	25	\$ 318.24
	153Mi		1"	100	10	\$ 415.34
	154Mi		1-1/4"	100	10	\$ 699.62
	155Mi		1-1/2"	50	5	\$ 1,339.61
	156Mi		2"	40	10	\$ 1,923.67
	157Mi		2-1/2"	-	1	\$ 5,018.80
	158Mi		3"	-	1	\$ 7,005.43
	159Mi		3-1/2"	-	1	\$ 11,643.60
	160Mi		4"	-	1	\$ 13,194.15
<b>90° Flex Connector - Malleable Iron</b>						
	101M		1/2"	250	25	\$ 172.84
	102M		3/4"	100	10	\$ 311.58
	103M		1"	50	5	\$ 505.24
	104M		1-1/4"	-	50	\$ 1,241.34
	105M		1-1/2"	-	5	\$ 1,474.92
	106M		2"	-	5	\$ 3,653.72
	107M		2-1/2"	-	5	\$ 3,902.28
	108M		3"	-	2	\$ 20,361.74
	109M		3-1/2"	-	1	\$ 26,970.12
	110M		4"	-	1	\$ 50,432.00
<b>90° Flex Connector - Insulated Throat - Malleable Iron</b>						
	101Mi		1/2"	250	25	\$ 259.26
	102Mi		3/4"	100	10	\$ 566.20
	103Mi		1"	50	5	\$ 846.00
	104Mi		1-1/4"	-	50	\$ 1,474.80
	105Mi		1-1/2"	-	5	\$ 2,951.20
	106Mi		2"	-	5	\$ 5,687.40
	107Mi		2-1/2"	-	5	\$ 7,499.20
	108Mi		3"	-	2	\$ 24,231.20
	109Mi		3-1/2"	-	1	\$ 45,061.20
	110Mi		4"	-	1	\$ 96,515.60

**Combination Coupling**



4157-DC



Coupling used to join duplex 14/2 to 10/3 armored or MC cable to 3/4" EMT

1/2" with 3/4" KO

100

25

\$

372.08

	Catalogue Number	Alternate Cat. No.	Size or Description	Packaging		List Price
				Case	Box	

**WHIPPER SNAP' Connectors - Snap-in type connectors**

	380SP		3/8" Snap-In/Snap-In AC/MC/FMC Connector	500	50	\$	136.00
	38ASP		3/8" Insulated Snap-In/Snap-In AC/MC/FMC Connect	500	50	\$	138.00
	3838SP		3/8" Duplex Snap-In/Snap-In AC/MC/FMC Connector	250	25	\$	292.00
	3838ASP		3/8" Insulated Duplex Snap-In/Snap-In AC/MC/FMC Conn.	250	25	\$	298.00
	SG38SP		3/8" Saddle Type Snap-In AC/MC Connector	500	50	\$	135.00
	SG38ASP		3/8" Insulated Saddle Type Snap-In AC/MC Connector	500	50	\$	137.00
	802SP		3/8" 90° 1-Screw Snap-In FMC/MC Connector	250	25	\$	164.00
	850SP		3/8" 90° 2-Screw Snap-In FMC/MC Connector	250	25	\$	167.00
	846SP		3/8" Duplex Snap-In AC/MC/FMC Connector	200	20	\$	214.00
	841SP		3/8" 2-Screw Strap Type Romex Snap-In Connector	1000	100	\$	63.00
	651SP		3/8" 1-Screw Strap Type Romex Snap-In Connector	1000	100	\$	63.00
	8400SP		3/8" 2-Screw Strap Type AC/MC Snap-In Connector	1000	100	\$	107.00
	GF38SP		3/8" Snap-In 'Jake' Style FMC Connector	1000	100	\$	95.00

**One Screw Connectors (L-series) for BX, Flex, NM - Zinc**









				Skid Qty.				
	L-16	-	3/8" (1/2" KO)	28,000	500	50	\$	95.54
	L-17	BL-17	1/2"	11,200	250	25	\$	338.65
	L-18	BL-18	3/4"	9,600	200	20	\$	407.30
	L-19	BL-19	1"	4,800	100	10	\$	796.90



**PVC "Snap in" Connector**

	618-NM		14/2 to 10/3 (1/2"KO)	1000	100	\$	27.30/c
	618-NMB		14/2 to 10/3 (1/2"KO)	300 pcs in Bucket		\$	81.90/bucket
	RC75		8/3 to 6/3 (3/4"KO)	500	50	\$	72.50/c
	RC75J		8/3 to 6/3 (3/4"KO)	165 in a Jar		\$	117.80/jar

**1-Screw Duplex Connector - Zinc Die Cast**

	350	601-DC2	3/8" With 1/2" Knock out	200	20	\$	225.54
---	-----	---------	--------------------------	-----	----	----	--------

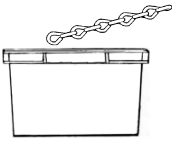
	Catalogue Number	Alternate Cat. No.	Size or Description	Packaging		List Price
				Case	Box	
<b>Squeeze Strap Type Connector</b>						
	653-DC2		.620 - .780 MC (1/2"KO)	250	25	\$ 393.80
<b>2-Screw Duplex Connector - Zinc Die Cast</b>						
	360	602-DC2	3/8" With 1/2" Knock out	250	25	\$ 237.50
<b>90° Duplex Connector - Zinc Die Cast</b>						
	561A	830-DC2	3/8" With 1/2" Knock out	250	25	\$ 1,203.13
<b>EMT to Flex Coupling - Zinc Die Cast</b>						
	180	280-DC2	1/2" x 3/8"	100	25	\$ 324.35
	181	281-DC2	1/2" x 1/2"	250	25	\$ 459.13
	282-DCX	282-DCX	3/4" x 1/2"	100	25	\$ 779.00
	182	282-DCX	3/4" x 3/4"	100	25	\$ 640.83
	182A	283-DC	1" x 1"	100	10	\$ 805.21
<b>NM Clamp Type Connectors - Two screw - Zinc Die Cast</b>						
	120	566-DC2	1/2" (3/8" NM Cable)	1000	100	79.08
<b>Flex Connectors - Screw in - Zinc Die Cast</b>						
	450	519-DC2	3/8"	500	50	\$ 109.42
	451	520-DC2	1/2"	500	50	\$ 121.54
	452	521-DC2	3/4"	250	25	\$ 268.46
	453	522-DC2	1"	250	25	\$ 709.79
	454	523-DC2	1-1/4"	100	10	\$ 1,591.63
	455	524-DC2	1-1/2"	40	10	\$ 2,933.02
	456	525-DC2	2"	40	10	\$ 4,501.04
<b>Flex Couplings -Screw in - Zinc Die Cast</b>						
	461	530-DC	1/2"	500	50	\$ 227.29
	462	531-DC	3/4"	250	25	\$ 372.88
	463	532-DC	1"	250	25	\$ 650.21
	464	533-DC	1-1/4"	100	10	\$ 1,397.50
	465	534-DC	1-1/2"	40	10	\$ 1,804.83
	466	535-DC	2"	40	10	\$ 3,556.58
<b>Clamp Connector - for Oval NM cable</b>						
	952	670-DC2	3/4"	250	25	\$ 176.15
	953	672-DC2	1"	250	25	\$ 317.42
	954	674-DC2	1-1/4"	100	10	\$ 481.21
	955	675-DC2	1-1/2"	100	10	\$ 863.42
	956	676-DC2	2"	50	5	\$ 1,037.40
<b>Clamp Connector - for NM &amp; SE cable</b>						
	143R	662-DC2	1"	250	25	\$ 305.21
	144R	664-DC2	1-1/4"	100	10	\$ 462.71
	145R	665-DC2	1-1/2"	100	10	\$ 830.21
	146R	666-DC2	2"	50	5	\$ 997.50

Catalogue Number	Alternate Cat. No.	Size or Description	Packaging		List Price	
			Case	Box		
<b>Jack Chain - Steel - Bright Zinc Plated</b>						
JC10-50		T10 43lbs.	300	50	\$ 40.95 / c'	
JC10-100		T10 43lbs.	600	100	\$ 40.95 / c'	
JC10-250R		T10 43lbs.	250' <i>reel</i>		\$ 105.00/reel	
JC10-250B		T10 43lbs.	250' <i>bucket</i>		\$ 105.00/bucket	
		JC12-50	T12 29lbs	300	50	\$ 38.43 / c'
		JC12-300R	T12 29lbs	300' <i>reel</i>		\$ 116.00/reel
		JC12-300B	T12 29lbs	300' <i>bucket</i>		\$ 116.00/bucket
<b>B = Bucket R = Reel</b>		JC14-100	T14 16lbs.	1000	100	\$ 36.00 / c'
		LC2-100	#2 115lbs.	600	100	\$ 46.53 / c'
		LC3-100	#3 90lbs.	600	100	\$ 32.84 / c'
		LC3-300R	#3 90lbs.	300' <i>reel</i>		\$ 99.00/reel
		LC3-300B	#3 90lbs.	300' <i>bucket</i>		\$ 99.00/bucket
		LC4-100	#4 70lbs.	600	100	\$ 57.61 / c'
		LC4-250B	#4 70lbs.	250' <i>bucket</i>		\$ 144.00/bucket
<b>STAINLESS STEEL - #10 Jack Chain</b>		JC10-100-SS	#10 43lbs.		100	\$ 362.00 / c'



\*\*\* Please note: 60 Buckets of Jack Chain on a skid. Custom labeling available on orders of 20 Buckets or More. \*\*\*

**S-Hooks**



S10		T10	1000	100	\$ 7.50
-----	--	-----	------	-----	---------

**Poly Twine & Yellow Polypro Rope**











	max pull strength		Reel Length		
PTW-1/4	1120 lbs.	1/4"	1,300'	\$	40.000
PTW-5/16	1450 lbs.	5/16"	975'	\$	40.000
PTW-3/8	2250 lbs.	3/8"	630'	\$	40.000
PTW-1/2	4200 lbs.	1/2"	335'	\$	40.000
PL-210	210 lbs	Poly-Tying Twine	6,500' / Pail	\$	38.000

**Caution Tape**



<i>Non-Detectable</i>					
1591	Yellow "CAUTION" 4 mil	3" X 300'	-	16	\$ 900.00
1592		3" X 1000'	-	8	\$ 2,550.00
1593	Red "CAUTION BURIED ELECTRIC LINE BELOW" 4 mil	3" X 200'	-	16	\$ 810.00
1594		3" X 1000'	-	8	\$ 2,550.00
1595		6" X 1000'	-	4	\$ 5,340.00
<i>Detectable</i>					
1596	Red "CAUTION BURIED ELECTRIC LINE BELOW" 5 mil	2" x 1000'	-	8	\$ 7,906.00
1597		3" X 1000'	-	8	\$ 8,556.00
1598		6" X 1000'	-	4	\$ 15,600.00

	Catalogue Number	Alternate Cat. No.	Size or Description	Packaging			List Price
				Case	Box		
<b>PVC Electrical Tape</b>							
	866T	Black	3/4" X 66'	200	10	\$	60.00
	866BLU	Blue	3/4" X 66'	200	10	\$	90.00
	866BRN	Brown	3/4" X 66'	200	10	\$	90.00
	866GRN	Green	3/4" X 66'	200	10	\$	90.00
	866GRY	Grey	3/4" X 66'	200	10	\$	90.00
	866ORN	Orange	3/4" X 66'	200	10	\$	90.00
	866PUR	Purple	3/4" X 66'	200	10	\$	90.00
	866RED	Red	3/4" X 66'	200	10	\$	90.00
	866WHT	White	3/4" X 66'	200	10	\$	90.00
	866YEL	Yellow	3/4" X 66'	200	10	\$	90.00
<b>COLD WEATHER - PVC Electrical Tape</b>							
	POLAR250	Premium Quality Cold and Weather Resistant Tape	3/4" X 66'	100	1	\$	505.00
<b>Rubber Splicing Tape</b>							
	870	Black	3/4" X 22YD	-	100	\$	6.10
	870C	Black	2" X 22YD	-	50	\$	16.20
<b>Duct Tape - Gray</b>							
	868		2" X 60YD	-	24	\$	8.24
<b>EZ Pull Wire Pulling Compound</b>							
	1200		1 quart	10	-	\$	1,182.00
	1201		1 gallon	4	-	\$	3,058.00
	1202		5 gallon pail	1	-	\$	11,220.00
<b>Antiox Contact Compound</b>							
	1209		4 ounce bottle	12	-	\$	1,134.00
	1210		8 ounce bottle	12	-	\$	2,057.00
<b>Duct Seal Compound (Gray, Asbestos Free)</b>							
	961		1 Lb. block	50	-	\$	298.38
	965		5 Lb. block	10	-	\$	1,436.86
<b>Firestop Compound - Gun Type</b>							
	FS-1000		10.50 Fluid ounces (310mL)	12	1	\$	1,420.00
<b>Nail Plates - With Prongs</b>							
	187		1-1/2" x 6"	199	-	\$	34.43
	188		1-1/2" x 5"	100	-	\$	31.30
	189		1-1/2" x 2-1/2"	200	-	\$	13.15
	189B		1-1/2" x 2-1/2" x 1/16"	200	50	\$	13.46
	189-100		1-1/2" x 2-1/2" x 1/16"	100	-	\$	13.15

Catalogue Number	Alternate Cat. No.	Size or Description	Packaging		List Price
			Case	Box	

**Swivel Fixture Aligner**



BA-07R	4" Round 50 lbs Load Rating Allows 20° Swing from Vertical	3/4" cw RB0705	-	10	\$	1,354.00
--------	--	----------------	---	----	----	----------

BA-07	4" SQUARE 50 lbs Load Rating Allows 20° Swing from Vertical	3/4" cw RB0705	-	10	\$	1,354.00
-------	---	----------------	---	----	----	----------



<b>"KWICK-HANG"</b>						
SC-5075HF	4" Square	1/2" or 3/4"	-	25	\$	1,699.70
SC-5075HFR	4" Round	1/2" or 3/4"	-	25	\$	1,557.10
50 lbs Load Rating Allows 20° Swing from Vertical						

**Rubber Pigtail Lightbulb Socket**



PT-123	cULus Listed	-	100	\$	300.00
PT-123B		-	250	\$	300.00

**Tie Wire (Steel - 16 Guage)**



TW16		300' / coil	16	1	\$	1,067.58
------	--	-------------	----	---	----	----------

**Perforated Strapping**



962		3/4" x 10'	50	-	\$	1,070.00
-----	--	------------	----	---	----	----------

**Cable Stacker & Supports**



NMWH-43	Cable Stacker			25	\$	114.00
---------	---------------	--	--	----	----	--------



NMCB-1	AC/NM Cable Support			25	\$	88.00
--------	---------------------	--	--	----	----	-------











NMCB-2	NM Cable Bracket			25	\$	88.00
--------	------------------	--	--	----	----	-------



NMCB-3	AC Cable Support			25	\$	88.00
--------	------------------	--	--	----	----	-------

Please see the new 2009 Bridgeport Catalogue (pg. 91, 92) for product specifications including wire ranges and combinations.



Catalogue Number	Alternate Cat. No.	Size or Description	Packaging		List Price
			Case	Box	
<b>Electrical Box Extender / Insulator</b>					
	BXE-100	<p>BXE-100 is for use with single device box. Corrects up to 1" setback.</p> <p>BXE-200 is for use with two device 4" square box. Corrects up to 1" setback.</p> <p>BXE-300 is for use with a 4" octagonal or round box. Corrects up to 5/8" setback.</p>	100	25	#REF!
	BXE-200		25	-	#REF!
	BXE-300		25	-	#REF!
<b>Low Voltage Device Holders for New Work</b>					
	NMLV-100F	<p>The NMLV-100B &amp; NMLV-200B are single and double gang low voltage device holders used for new work on 2"x4" wood or steel studs with 1/2" or 3/4" EMT. Provided with 2 nails for use on 2"x4" wood studs. Use #6 flat head screws for steel stud. Steel bracket will accommodate 1/2" or 3/4" EMT connector.</p>	100	10	#REF!
	NMLV-200F		50	5	#REF!
	NMLV-100B	<p>The NMLV-100F &amp; NMLV-200F are single and double gang low voltage device holders used for new work on 3/4" thick furring strips, 2"x4" wood or steel studs. Provided with 2 nails for use on 2"x4" wood studs. Use #6 flat head screws for steel stud of 3/4" thick furring strip</p>	50	5	#REF!
	NMLV-200B		50	5	#REF!
<b>Steel Data Plate Mounting Bracket</b>					
	LVB-1	<p>Eliminates need for outlet box. Provides mounting base for securing communication or data line face plates.</p> <p>Mounts standard low voltage outlets and plates (Class 2 only).</p> <p>Hardware included.</p>	100	10	#REF!

Catalogue Number	Alternate Cat. No.	Size or Description	Packaging		List Price
			Case	Box	

**Strut Pipe Clamps - zinc plated**

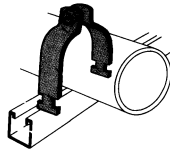

1/2" - 2" for EMT  
2-1/2" - 4" EMT or Rigid

GPC-05	1/2"	100 pair	10 pair	\$	72.00
GPC-07	3/4"	100 pair	10 pair	\$	76.00
GPC-10	1"	50 pair	10 pair	\$	79.00
GPC-12	1-1/4"	50 pair	10 pair	\$	94.00
GPC-15	1-1/2"	50 pair	5 pair	\$	105.00
GPC-20	2"	50 pair	5 pair	\$	115.00
GPC-25	2-1/2"	25 pair	5 pair	\$	146.00
GPC-30	3"	25 pair	5 pair	\$	158.00
GPC-35	3-1/2"	25 pair	5 pair	\$	205.00
GPC-40	4"	25 pair	5 pair	\$	220.00

**Steel Conduit Hangers - With Bolts & Nuts Attached - zinc plated**



	Trade Size	for Rigid		for EMT				
601	0	3/8" - 1/2"	1/2"	100	\$	62.11		
602	1	3/4"	3/4"	100	\$	71.22		
603	2	1"	1"	100	\$	84.80		
604A	2½	---	1-1/4"	100	\$	100.30		
604	3	1-1/4"	1-1/2"	100	\$	106.60		
605	4	1-1/2"	---	100	\$	151.30		
606	5	2"	2"	50	\$	203.75		
607	6	2-1/2"	2-1/2"	50	\$	275.85		
608	7	3"	3"	25	\$	324.94		
609	8	3-1/2"	3-1/2"	25	\$	323.90		
610	9	4"	4"	25	\$	408.95		

**STAINLESS STEEL Conduit Hangers - With Bolts & Nuts Attached (Type 304 Stainless)**



	Trade Size	for Rigid		for EMT				
2100-S	0	3/8" - 1/2"	1/2"	100	\$	453.75		
2110-S	1	3/4"	3/4"	100	\$	467.50		
2120-S	2	1"	1"	100	\$	536.25		
2125-S	2½	---	1-1/4"	50	\$	618.75		
2130-S	3	1-1/4"	1-1/2"	50	\$	618.75		
2140-S	4	1-1/2"	---	50	\$	797.50		
2150-S	5	2"	2"	50	\$	893.75		
2160-S	6	2-1/2"	2-1/2"	25	\$	1,237.50		
2170-S	7	3"	3"	25	\$	2,062.50		
2180-S	8	3-1/2"	3-1/2"	10	\$	2,200.00		
2190-S	9	4"	4"	10	\$	2,337.50		

**Threaded Rod**

Zinc Plated UNC All Threaded Steel Rod



Part No.	Size	Length	Pieces per bundle				
TR-025	1/4"	x 10'	(25)	250' / bundle	\$	45.00	
TR-038	3/8"	x 10'	(20)	200' / bundle	\$	65.00	
TR-050	1/2"	x 10'	(12)	120' / bundle	\$	105.00	

Please note: Threaded rod is sold in FULL BUNDLES ONLY

**Beam Clamps**

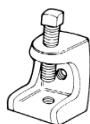

Part No.	Material	Size	Tapping				
122	Malleable Iron	1"	1/4 - 20	50	\$	253.10	
123		2"	3/8 - 16	50	\$	638.20	
124		2-1/2"	1/2 - 13	25	\$	1,030.30	
122S	Steel	1"	1/4 - 20	100	\$	81.90	
123S		2"	3/8 - 16	50	\$	254.26	

Catalogue Number	Alternate Cat. No.	Size or Description	Packaging		List Price	
			Case	Box		
<b>Knock-Out Bushings - 6/6 Nylon</b>						
		Inside Diameter	K.O. Size			
	SB8756	3/8"	1/2"	1000	100	\$ 12.39
	SB8757	7/16"	1/2"	1000	100	\$ 12.39
	SB8758	1/2"	1/2"	1000	100	\$ 16.52
	SB8759	9/16"	1/2"	1000	100	\$ 16.52
	SB87510	5/8"	1/2"	1000	100	\$ 14.46
	SB87511	11/16"	1/2"	1000	100	\$ 14.46
	SB109313	13/16"	3/4"	1000	100	\$ 14.46
	SB109314	7/8"	3/4"	1000	100	\$ 16.52
	SB109315	15/16"	3/4"	1000	100	\$ 16.52
	SB137514	7/8"	1"	1000	100	\$ 22.72
	SB137516	1"	1"	1000	100	\$ 22.72
	SB175022	1-3/8"	1-1/4"	500	50	\$ 24.78
	SB200026	1-5/8"	1-1/2"	500	50	\$ 30.98
	SB2.531	1-31/32"	2"	100	10	\$ 82.60
	SB3.039	1-15/32"	2-1/2"	100	10	\$ 99.12
	SB3.547	2-15/16"	3"	100	10	\$ 247.80
	SB4.055	3-7/16"	3-1/2"	100	10	\$ 206.50

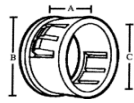

CAT #	A	B	C
SB8756	.375	.953	.453
SB8757	.438	.953	.453
SB8758	.500	.953	.453
SB8759	.563	.953	.453
SB87510	.625	.953	.453
SB87511	.688	.953	.453
SB109313	.813	1.219	.453
SB109314	.875	1.219	.453
SB109315	.938	1.219	.453
SB137514	.875	1.469	.453
SB137516	1.000	1.469	.453
SB175022	1.375	1.875	.453
SB200026	1.625	2.125	.453
SB2.531	1.969	2.656	.719
SB3.039	2.469	3.156	.719
SB3.547	2.938	3.656	.719
SB4.055	3.438	4.156	.719

**Stud Bushings**



9882	Universal Steel Stud Bushing	-	50	\$	50.50
------	------------------------------	---	----	----	-------



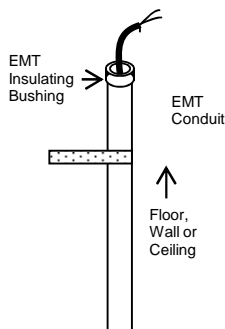

**Insulating Bushings for EMT Conduit**



1661		1/2"	1000	100	\$	7.36
1662		3/4"	1000	100	\$	11.27
1663		1"	500	50	\$	43.70
1664		1-1/4"	250	25	\$	66.70
1665		1-1/2"	250	25	\$	92.00
1666		2"	200	20	\$	124.20
1667	*	2-1/2"	25	-	\$	402.50
1668	*	3"	25	-	\$	494.50
1669	*	3-1/2"	25	-	\$	903.90
1670	*	4"	25	-	\$	1,081.00



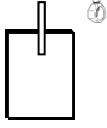
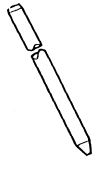















\* 2-1/2" - 4" Also will fit Rigid Steel Conduit

Insulating Bushings for EMT Conduit protect cables from abrasion by the conduit. Press fit...bushing holds firmly in place while pulling cables.

	Catalogue Number	Alternate Cat. No.	Size or Description	Packaging		List Price
				Case	Box	
<b>Ground Clamps</b>						
	G3	4/0 Connector	1/2" - 1"	-	50	\$ 1,300.00
	G4	4/0 Connector	1-1/4" - 2"	-	25	\$ 2,150.00
	G15	4/0 Connector	2-1/2" - 4"	-	4	\$ 4,900.00
	G16	4/0 Connector	4-1/2" - 6"	-	4	\$ 6,750.00
	620DB	Direct Burial	1/2" - 1"	250	25	\$ 400.00
	620Z	Zinc Die Cast	1/2" - 1"	250	25	\$ 239.21
	620BP	Brass Pltd. ZDC	1/2" - 1"	250	25	\$ 321.10
	626BS	Brass Screws	1/2" - 1"	100	10	\$ 506.00
	626B	Brass, Stl Screws	1-1/4" - 2"	50	5	\$ 990.00
	626C	Brass, Stl Screws	2-1/2" - 4"	10	-	\$ 3,339.60
	630B	Brass	1/2" - 1"	250	25	\$ 397.59
	630	Brass	1-1/4" - 2"	250	25	\$ 799.55
	630DB	Direct Burial	1-1/4" - 2"	100	20	\$ 966.42
<b>Ground Electrode Plate - Galvanised Steel</b>						
	GPC1016	10"x16"x1/4" Plate 5/8" Stud, c/w Bronze Grnd. Connector			2	\$ 3,739.44
	GP1016	10"x16"x1/4" Plate 5/8" Welded Stud, no connector			2	\$ 2,741.39
<b>Ground Rods - Galvanised &amp; Copper</b>						
				<u>Pieces per bundle</u>		
	GR6256	Galvanised	5/8" x 6'		10 (60' total)	\$ 12.35
	6256-C	Copper	5/8" x 6'		10 (60' total)	\$ 15.14
	GR6258	Galvanised	5/8" x 8'		10 (80' total)	\$ 16.10
	6258-C	Copper	5/8" x 8'		10 (80' total)	\$ 32.84
	GR7508	Galvanised	3/4" x 8'		5 (40' total)	\$ 20.50
	7508-C	Copper	3/4" x 8'		5 (40' total)	\$ 36.78
	GR6260	Galvanized	5/8" x 10'		5 (50' total)	\$ 20.60
	6260-C	Copper	5/8" x 10'		5 (50' total)	\$ 41.20
	GR7510	Galvanised	3/4" x 10'		3 (30' total)	\$ 23.83
	7510-C	Copper	3/4" x 10'		3 (30' total)	\$ 43.78
<b>Ground Rod Clamps - Bronze</b>						
	411		1/2" (10 sol. - 1/0 str.)		100	\$ 354.33
	412		5/8" (8 sol. - 1/0 str.)		100	\$ 416.94
	413		3/4" (8 sol. - 1/0 str.)		50	\$ 506.58
	413H		3/4" (8sol. - 3/0 str.)		50	\$ 292.98

	Catalogue Number	Alternate Cat. No.	Size or Description	Case	Packaging Box	List Price
<b>Steel Cover Plates</b>						
	175		One Gang Cover - Round - White		50	\$ 393.10
	11C1		Duplex Receptacle		50	\$ 137.60
	11C2		1-19/32" Diameter Hole - 20 Amp		50	\$ 197.15
	11C3		1-13/32" Diameter Hole - 15 Amp		50	\$ 186.76
	11C4		Blank cover		50	\$ 148.68
	11C5		Toggle Switch		50	\$ 148.68
	11C10	89401	Single GFI - Decora Style		50	\$ 139.50
	52C0	11221	Single Device - Flat		100	\$ 305.34
	52C00	11235	Two Device - Flat		100	\$ 425.41
	52C1	11201	4" Square - Blank		50	\$ 124.56
	52C3	11214	4" Square 5/8" Raised, 3" KO		100	\$ 418.01
	52C3-1/2	11215	4" Square 1/2" Raised, 3" KO		100	\$ 418.01
	52C6	11203	4" Square - 1/2" Knock-out		50	\$ 168.02
	52C10	11222	Single Device - 1/8" Raised		100	\$ 353.81
	52C13	11226	Single Device - 1/2" Raised		100	\$ 258.66
	52C14	11228	Single Device - 3/4" Raised		50	\$ 368.60
	52C14-5/8	11227	4" SQ. 1 Device Cover Raised 5/8"		50	\$ 380.16
	52C15	11230	Single Device - 7/8" Raised		50	\$ 391.73
	52C16	11231	Single Device - 1 1/4" Raised		50	\$ 415.15

	Catalogue Number	Alternate Cat. No.	Size or Description	Case	Packaging Box	List Price
<b>Steel Cover Plates</b>						
	52C17	11240	2 Device - 1/2" Raised		50	\$ 422.00
	52C18	11242	2 Device, Raised 3/4"		25	\$ 523.58
	52C18-5/8"	11241	4" SQ. 2 Device, Raised 5/8"		50	\$ 651.50
	52C49-1/2	11261	Single Device, 1/2" Raised		50	\$ 780.57
	52C49-3/4	11262	Single Device, 3/4" Raised		50	\$ 912.29
	52C49-1	11263	Single Device, 1" Raised		50	\$ 927.49
	52C49-1 1/4	11264	Single Device, 1 1/4" Raised		50	\$ 956.93
	52C49-1 1/2	11265	Single Device, 1 1/2" Raised		50	\$ 1,133.52
	52C49-2	11266	Single Device, 2" Raised		50	\$ 1,183.15
	52C52-1/2	11271	4" Two Device, 1/2" Raised, Tile		50	\$ 1,744.66
	52C52-3/4	11272	4" Two Device, 3/4" Raised, Tile		50	\$ 1,978.75
	52C52-1	11273	4" Two Device, 1" Raised, Tile		50	\$ 2,018.75
	52C52-1 1/4	11274	4" Two Device, 1-1/4" Raised, Tile		50	\$ 2,080.00
	52C52-1 1/2	11275	4" Two Device, 1-1/2" Raised, Tile		50	\$ 2,283.00
	52C52-2	11276	4" Two Device, 2" Raised, Tile		50	\$ 2,408.00
	52C62	11223	4" Single Gang Switch, 1/4" Raised		50	\$ 250.00
	54C1	11101	4" Round Blank		50	\$ 107.43
	54C6	11103	4" Round - 1/2" Knock-out		50	\$ 115.97

	Catalogue Number	Alternate Cat. No.	Size or Description	Case	Packaging Box	List Price
<b>Steel Cover Plates</b>						
	54C64		4" Round - 15 Amp 1-1/32" Opening		50	\$ 220.00
	11109		4" Round - 20 Amp 1.5937 Opening		100	\$ 220.00
	54C65	11105	4" Round - Single Receptacle		100	\$ 225.22
	54C94	11108	4" Round - Single Switch		100	\$ 236.06
	54C3-1/2	11215	4" Round, 3" Opening, Raised 1/2"		100	\$ 2,150.00
	54C3	11124	4" Round, 3" Opening, Raised 5/8"		100	\$ 2,400.00
	72C0	11321	4-11/16" Sq. - Single Device Flat		50	\$ 450.00
	72C00	11335	4-11/16" Sq. - Two Device Flat		50	\$ 487.00
	72C1	11301	4-11/16" Sq. - Single Device		50	\$ 299.30
	72C6	11303	4-11/16" Sq. 1/2" Knock-out		50	\$ 418.56
	72C10		4-11/16" Sq. 3/16" Single Device		50	\$ 600.50
	72C13	11326	4-11/16" Sq. - Single Device - 1/2" R		50	\$ 641.17
	72C14	11328	4-11/16" Sq. - Single Device - 3/4" R		50	\$ 678.84
	72C15	11330	4-11/16" Sq. - Single Device - 1" R		50	\$ 712.52
	72C16	11331	4-11/16" Sq. - Single Device - 1-1/4" R		50	\$ 649.00
	72C17	11340	4-11/16" Sq. - 2 Device - 1/2" Raised		50	\$ 712.52
	72C18	11342	4-11/16" Sq. - 2 Device - 3/4" Raised		50	\$ 799.10
	72C19	11344	4-11/16" Sq. - 2 Device - 1" Raised		50	\$ 772.00
	72C21	11345	4-11/16" Sq. - 2 Device - 1 1/4" Raised		50	\$ 811.00

**NE12-LIST**

Effective Date: August 1, 2010



	Catalogue Number	Alternate Cat. No.	Size or Description	Case	Packaging Box		List Price
	72C62	11323	4-11/16" Sq. - Single Device - 1/4" R		50	\$	531.00
	72R2D	11511	4-11/16" Sq. - Double Duplex Cover		25	\$	987.00
	72R23R	11529	4-11/16" Sq. - 2 x 1.620" Dia. Twist Lock Receptacle		25	\$	1,075.00
	RS9	8361 / 11401	4" Sq. - 1/2" Raised - 1 Toggle		50	\$	442.38
	RS12	8365 / 11402	4" Sq. - 1/2" Raised - 1 Duplex		50	\$	384.33
	RS2	8375 / 11413	4" Sq. - 1/2" Raised Toggle / Duplex		50	\$	476.49
	RS5	8367 / 11410	4" Sq. - 1/2" Raised - 2 Toggle		50	\$	476.49
	RS8	8371 / 11411	4" Sq. - 1/2" Raised - 2 Duplex		50	\$	410.64
	RS11	8363 / 11403	4" Sq. - 1/2" Raised - 1 Receptacle		50	\$	459.38
	820D		Rework F-Bracket <b>Sold in Pairs</b>		300	\$	72.58
	11424	8366	4" Sq. - 1/2" Raised - 2.165" Diameter		50	\$	854.37
	11426	8362	4" Sq. - 1/2" Raised - 2.625" Diameter		50	\$	684.34
	11421	8364	4" Sq. - 1/2" Raised - 1.620 Diameter		50	\$	476.49
	11432		4" Sq. - GFCI Cover		50	\$	547.00
	11433		4" Sq. - 1/2" Raised, Double GFI		50	\$	637.00





Conduit  
Bodies

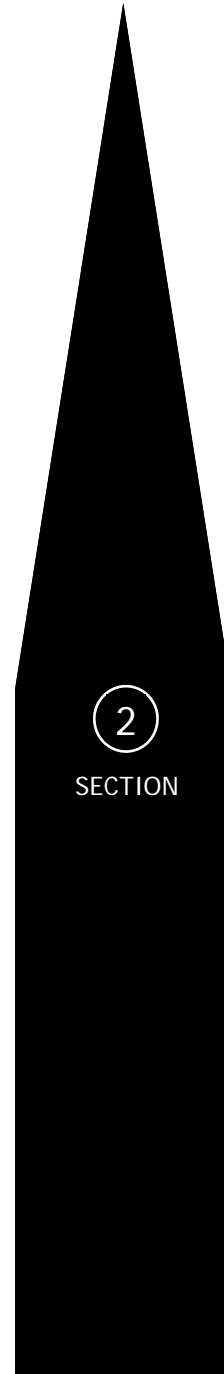

August 1, 2010

Catalogue Number	Topaz Cat. No.	Size	Packaging		LIST PRICE PER 100
			Case	Box	

**Conduit Bodies - Copper Free Aluminum - complete with cover & gasket**

**'C' - Combination Conduit Body EMT (Set Screw) / Rigid (Threaded)**



CC-05		½	-	10	\$	964.46
CC-07		¾	-	10	\$	1,083.01
CC-10		1	-	5	\$	1,455.90
CC-12		1¼"	-	10	\$	2,298.43
CC-15		1½"	-	10	\$	3,844.22
CC-20		2	-	5	\$	5,831.81

**'C' Rigid Conduit Body - Threaded only (Requires connectors for EMT)**

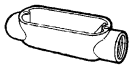

C7GC		2½	-	1	\$	19,793.61
C8GC		3	-	1	\$	25,578.55
C9GC		3½	-	1	\$	40,946.51
C10GC		4	-	1	\$	45,497.11

**'C' Rigid Conduit Body - SET SCREW ONLY - FOR EMT**



EC7GC		2½	-	1	\$	19,793.61
EC8GC		3	-	1	\$	25,578.55
EC9GC		3½	-	1	\$	40,946.51
EC10GC		4	-	1	\$	45,497.11

**'LB' - Combination Conduit Body EMT (Set Screw) / Rigid (Threaded)**

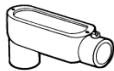

CLB-05		½	-	10	\$	762.29
CLB-07		¾	-	10	\$	919.40
CLB-10		1	-	5	\$	1,300.48
CLB-12		1¼"	-	10	\$	1,999.04
CLB-15		1½"	-	10	\$	2,488.19
CLB-20		2	-	5	\$	4,220.48

**'LB' Rigid Conduit Body - Threaded only (Requires connectors for EMT)**



LB7GC		2½	-	1	\$	13,863.61
LB8GC		3	-	1	\$	16,670.72
LB9GC		3½	-	1	\$	28,427.35
LB10GC		4	-	1	\$	31,761.08

**'LB' Rigid Conduit Body - SET SCREW ONLY - FOR EMT**





ELB7GC		2½	-	1	\$	13,863.61
ELB8GC		3	-	1	\$	16,670.72
ELB9GC		3½	-	1	\$	28,427.35
ELB10GC		4	-	1	\$	31,761.08

**LL / LR' Combination Type Conduit Body EMT (Set Screw) / Rigid (Threaded)**

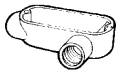
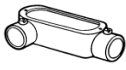
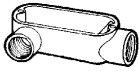

LLR-41		½	60	10	\$	910.00
LLR-42		¾	60	10	\$	1,072.00
LLR-43		1	30	5	\$	1,334.00
LLR-44		1¼"	10	2	\$	2,364.00
LLR-45		1½"	10	2	\$	2,470.00
LLR-46		2	5	2	\$	4,284.00

Complete with cover and gasket

					LIST
Catalogue		Topaz	Packaging		PRICE
Number	Cat. No.	Case	Box		PER 100
<b>Conduit Bodies - Copper Free Aluminum - complete with cover &amp; gasket</b>					
<b>'LL' - Combination Conduit Body EMT (Set Screw) / Rigid (Threaded)</b>					
	CLL-05	1/2	-	10	\$ 960.72
	CLL-07	3/4	-	10	\$ 1,130.24
	CLL-10	1	-	5	\$ 1,405.42
	CLL-12	1 1/4"	-	10	\$ 2,400.24
	CLL-15	1 1/2"	-	10	\$ 2,595.54
	CLL-20	2	-	5	\$ 4,407.11
<b>'LL' Rigid Conduit Body - Threaded only (Requires connectors for EMT)</b>					
	LL7GC	2 1/2	-	1	\$ 20,388.55
	LL8GC	3	-	1	\$ 25,593.37
	LL9GC	3 1/2	-	1	\$ 40,949.40
	LL10GC	4	-	1	\$ 47,772.41
<b>'LR' - Combination Conduit Body EMT (Set Screw) / Rigid (Threaded)</b>					
	CLR-05	1/2	-	10	\$ 960.72
	CLR-07	3/4	-	10	\$ 1,130.24
	CLR-10	1	-	5	\$ 1,405.42
	CLR-12	1 1/4"	-	10	\$ 2,400.24
	CLR-15	1 1/2"	-	10	\$ 2,595.54
	CLR-20	2	-	5	\$ 4,407.11
<b>'LR' Rigid Conduit Body - Threaded only (Requires connectors for EMT)</b>					
	LR7GC	2 1/2	-	1	\$ 20,388.55
	LR8GC	3	-	1	\$ 25,593.37
	LR9GC	3 1/2	-	1	\$ 40,949.40
	LR10GC	4	-	1	\$ 47,772.41
<b>'T' - Combination Conduit Body EMT (Set Screw) / Rigid (Threaded)</b>					
	CT-05	1/2	-	10	\$ 1,074.46
	CT-07	3/4	-	10	\$ 1,169.64
	CT-10	1	-	5	\$ 1,484.94
	CT-12	1 1/4"	-	10	\$ 2,473.37
	CT-15	1 1/2"	-	10	\$ 4,190.72
	CT-20	2	-	5	\$ 5,674.94
<b>'T' Rigid Conduit Body - Threaded only (Requires connectors for EMT)</b>					
	T7GC	2 1/2	-	1	\$ 23,963.49
	T8GC	3	-	1	\$ 30,533.37
	T9GC	3 1/2	-	1	\$ 44,571.57
	T10GC	4	-	1	\$ 56,153.25

Complete with cover and gasket

Catalogue Number	Topaz Cat. No.	Packaging			LIST
		Case	Box		PRICE PER 100

**Blank Cover - Aluminum**



571		½	250	25	\$	92.60
572		¾	250	25	\$	119.20
573		1	100	10	\$	209.90
574		1¼"-1½"	-	25	\$	280.90
576		2"	-	25	\$	501.20
577		2¼"-2½"	-	10	\$	1,875.00
579		3½"-4"	-	5	\$	2,213.00

**Solid Gasket - Neoprene**



581	SGN-61	1/2"	1000	100	\$	420.00
582	SGN-62	3/4"	1000	100	\$	420.00
583	SGN-63	1"	500	50	\$	611.00
584	SGN-64	1-1/4"	100	10	\$	775.00
584	SGN-65	1-1/2"	100	10	\$	943.00
586	SGN-66	2"	100	5	\$	1,382.00
587	SGN-67	2-1/2"	100	1	\$	2,267.00
587	SGN-67	3"	100	1	\$	2,267.00
589	SGN-69	3-1/2"	25	1	\$	3,632.00
589	SGN-69	4"	25	1	\$	3,632.00

All covers and Gaskets fit LB, LL, LR, C and T's,  
 Aluminum and Malleable, Set Screw and Rigid Bodies.

Catalogue Number	Alternat Cat. No.	Packaging		LIST PRICE PER 100
		Case	Box	

### Malleable Iron Conduit Bodies "FORM 35 Type"

#### 'C' Rigid Conduit Body - Threaded only - Malleable Iron

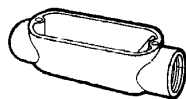

C1M	C-61	1/2"	50	5	\$	1,595.00
C2M	C-62	3/4"	50	5	\$	1,836.00
C3M	C-63	1"	20	2	\$	2,610.00
C4M	C-64	1-1/4"	10	2	\$	4,643.00
C5M	C-65	1-1/2"	10	2	\$	5,891.00
C6M	C-66	2"	6	1	\$	9,708.00
C7M	C-67	2-1/2"	-	1	\$	20,600.00
C8M		3"	-	1	\$	27,465.00
C9M		3-1/2"	-	1	\$	40,696.00
C10M		4"	-	1	\$	45,924.00

#### WITH ROLLERS - 'C' Rigid Conduit Body - Threaded only - Malleable Iron

C4M-R		1-1/4"	10	2	\$	5,618.03
C5M-R		1-1/2"	10	2	\$	7,128.11
C6M-R		2"	6	1	\$	11,746.68
C7M-R		2-1/2"	-	1	\$	24,926.00
C8M-R		3"	-	1	\$	33,232.65
C9M-R		3-1/2"	-	1	\$	49,242.16
C10M-R		4"	-	1	\$	55,568.04

#### 'LB' Rigid Conduit Body - Threaded only - Malleable Iron

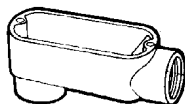

LB1M	LB-61	1/2"	50	5	\$	1,595.00
LB2M	LB-62	3/4"	50	5	\$	1,836.00
LB3M	LB-63	1"	20	2	\$	2,610.00
LB4M	LB-64	1-1/4"	10	2	\$	4,643.00
LB5M	LB-65	1-1/2"	10	2	\$	5,891.00
LB6M	LB-66	2"	6	1	\$	9,709.00
LB7M	LB-67	2-1/2"	-	1	\$	20,600.00
LB8M	LB-68	3"	-	1	\$	27,465.00
LB9M	LB-69	3-1/2"	-	1	\$	40,696.00
LB10M	LB-70	4"	-	1	\$	45,923.00

#### WITH ROLLERS - 'LB' Rigid Conduit Body - Threaded only - Malleable Iron

LB4M-R		1-1/4"	10	2	\$	5,618.03
LB5M-R		1-1/2"	10	2	\$	7,128.11
LB6M-R		2"	6	1	\$	11,746.68
LB7M-R		2-1/2"	-	1	\$	24,926.00
LB8M-R		3"	-	1	\$	33,232.65
LB9M-R		3-1/2"	-	1	\$	49,242.16
LB10M-R		4"	-	1	\$	55,568.04

Catalogue Number	Alternat Cat. No.		Packaging			LIST
			Case	Box		PRICE PER 100

**Malleable Iron Conduit Bodies "FORM 35 Type"**

**'LL' Rigid Conduit Body - Threaded only - Malleable Iron**

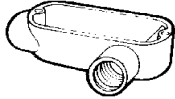

LL1M	LL-61	1/2"	50	5	\$	1,595.00
LL2M	LL-62	3/4"	50	5	\$	1,836.00
LL3M	LL-63	1"	20	2	\$	2,610.00
LL4M	LL-64	1-1/4"	10	2	\$	4,643.00
LL5M	LL-65	1-1/2"	10	2	\$	5,891.00
LL6M	LL-66	2"	6	1	\$	9,709.00
LL7M	LL-67	2-1/2"	-	1	\$	20,600.00
LL8M	LL-68	3"	-	1	\$	27,465.00
LL9M		3-1/2"	-	1	\$	40,696.00
LL10M		4"	-	1	\$	45,923.00

**'LR' Rigid Conduit Body - Threaded only - Malleable Iron**

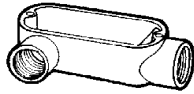

LR1M	LR-61	1/2"	50	5	\$	1,595.00
LR2M	LR-62	3/4"	50	5	\$	1,836.00
LR3M	LR-63	1"	20	2	\$	2,610.00
LR4M	LR-64	1-1/4"	10	2	\$	4,643.00
LR5M	LR-65	1-1/2"	10	2	\$	5,891.00
LR6M	LR-66	2"	6	1	\$	9,709.00
LR7M	LR-67	2-1/2"	-	1	\$	20,600.00
LR8M	LR-68	3"	-	1	\$	27,465.00
LR9M		3-1/2"	-	1	\$	40,696.00
LR10M		4"	-	1	\$	45,923.00

**'T' Rigid Conduit Body - Threaded only - Malleable Iron**

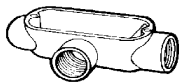





T1M	T-61	1/2"	50	5	\$	1,813.00
T2M	T-62	3/4"	50	5	\$	2,394.00
T3M	T-63	1"	20	2	\$	3,261.00
T4M	T-64	1-1/4"	10	2	\$	4,792.00
T5M	T-65	1-1/2"	10	2	\$	6,378.00
T6M	T-66	2"	6	1	\$	9,861.00
T7M	T-67	2-1/2"	-	1	\$	19,608.00
T8M	T-68	3"	-	1	\$	28,484.00
T9M		3-1/2"	-	1	\$	44,336.00
T10M		4"	-	1	\$	49,690.00

**'TB' Rigid Conduit Body - Threaded only - Malleable Iron**



TB1M		1/2"	50	5	\$	1,813.00
TB2M		3/4"	50	5	\$	2,394.00
TB3M		1"	20	2	\$	3,261.00
TB4M		1-1/4"	10	2	\$	4,792.00
TB5M		1-1/2"	10	2	\$	6,378.00
TB6M		2"	6	1	\$	9,861.00

	Catalogue Number	Alternat Cat. No.		Packaging			LIST
				Case	Box		PRICE PER 100
<b>Stamped Steel Covers</b>							
	571S	SC-61	1/2"	100	25	\$	302.00
	572S	SC-62	3/4"	100	25	\$	436.00
	573S	SC-63	1"	100	25	\$	530.00
	574S	SC-64	1-1/4"	100	10	\$	864.00
	574S	SC-64	1-1/2"	100	10	\$	864.00
	576S	SC-66	2"	-	25	\$	1,155.00
	577S	SC-67	2-1/2"	-	20	\$	2,453.00
	577S	SC-67	3"	-	20	\$	2,453.00
	579S	SC-69	3-1/2"	-	5	\$	2,895.00
	579S	SC-69	4"	-	5	\$	2,895.00
<b>Solid Gasket - Neoprene</b>							
	581	SGN-61	1/2"	1000	100	\$	420.00
	582	SGN-62	3/4"	1000	100	\$	420.00
	583	SGN-63	1"	500	50	\$	611.00
	584	SGN-64	1-1/4"	100	10	\$	775.00
	584	SGN-65	1-1/2"	100	10	\$	943.00
	586	SGN-66	2"	100	5	\$	1,382.00
	587	SGN-67	2-1/2"	100	1	\$	2,267.00
	587	SGN-67	3"	100	1	\$	2,267.00
	589	SGN-69	3-1/2"	25	1	\$	3,632.00
	589	SGN-69	4"	25	1	\$	3,632.00
<b>Stamped Steel Cover and Neoprene gasket (assembled)</b>							
	CG1		1/2"	1000	100	\$	435.00
	CG2		3/4"	1000	100	\$	435.00
	CG3		1"	500	50	\$	533.00
	CG4		1-1/4"	100	10	\$	613.00
	CG4		1-1/2"	100	10	\$	613.00
	CG5		2"	100	5	\$	815.00
	CG6		2-1/2"	100	1	\$	1,440.00
	CG6		3"	100	1	\$	1,440.00
CG7		3-1/2"	25	1	\$	1,807.00	
CG7		4"	25	1	\$	1,807.00	
<b>Mogul Conduit Bodies - Cast Aluminum</b>							
	MLB-47		2-1/2"	-	1	\$	302.42
	MLB-48		3"	-	1	\$	408.51
	MLB-49		3-1/2"	-	1	\$	428.50
	MLB-50		4"	-	1	\$	428.50

**IN STOCK...**

**AT NESCO**



## LOW PROFILE IN-USE WEATHERPROOF COVER

### ML400G

UPC: 092326-110594

- \* Revolutionary patented design expands from 1" all the way to 3½" to meet your while in use needs.
- \* Ultra Rugged Material - Heavy duty Polycarbonate and Synthetic neoprene rubber so it will not dry rot, crack or deteriorate in the sunlight.
- \* 100% paintable surface.
- \* Pre-attached gasket for ease of installation.
- \* Patented Quick fit Keyhole Technology for easy installation.

Part Number	Box Qty	List Price Per Each
<b>ML400G</b>	<b>10</b>	<b>\$ 19.80</b>

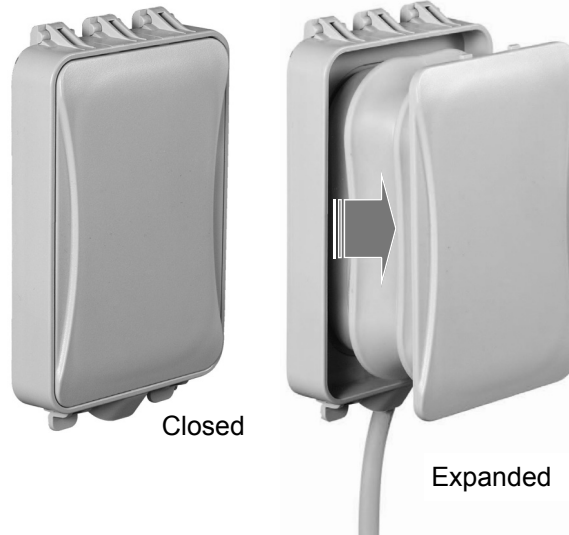

8<sup>in</sup>1

CONFIGURATIONS

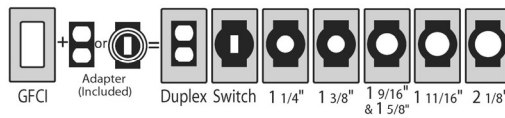

EXPANDS  
1" → 3½"

#### CUT-AWAY VIEW



ML400G.06.01.08

#### DIMENSIONS (INCHES)

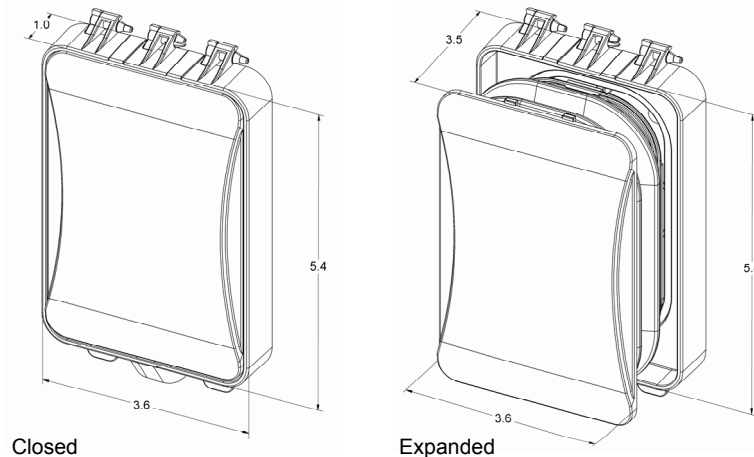

- \* Prices are in Canadian Dollars, F.O.B. Nesco Inc. warehouse.
- \* Prices are subject to change without notice.







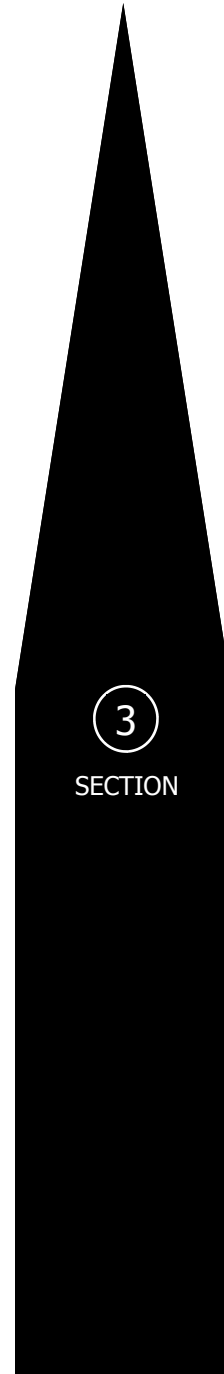



Explosion-Proof  
Fittings



August 1, 2010

	Catalogue Number	Size Description	Packaging		LIST PRICE PER EACH
			Case	Box	
<b>Explosion Proof - Pressure Cast Aluminum - Epoxy Coated</b>					
	GRB-0445	1/2" 2-Hub 'LB' Hazardous Location Round Outlet Box	4	1	\$ 111.18
	GRB-0446	3/4" 2-Hub 'LB' Hazardous Location Round Outlet Box	4	1	\$ 118.45
	GRB-0584	1" 2-Hub 'LB' Hazardous Location Round Outlet Box	4	1	\$ 123.54
	GRB-0597	1¼" 2-Hub 'LB' Hazardous Location Round Outlet Box	2	1	\$ 208.61
	GRB-0600	1½" 2-Hub 'LB' Hazardous Location Round Outlet Box	2	1	\$ 428.35
	GRB-0605	2" 2-Hub 'LB' Hazardous Location Round Outlet Box	2	1	\$ 443.86
	GRC-0443	1/2" 2-Hub 'C' Hazardous Location Round Outlet Box	4	1	\$ 111.16
	GRC-0444	3/4" 2-Hub 'C' Hazardous Location Round Outlet Box	4	1	\$ 118.47
	GRC-0556	1" 2-Hub 'C' Hazardous Location Round Outlet Box	4	1	\$ 123.52
	GRC-0589	1¼" 2-Hub 'C' Hazardous Location Round Outlet Box	2	1	\$ 208.61
	GRC-0561	1½" 2-Hub 'C' Hazardous Location Round Outlet Box	2	1	\$ 428.36
	GRC-0580	2" 2-Hub 'C' Hazardous Location Round Outlet Box	2	1	\$ 443.86
	GRE-0447	1/2" 1-Hub 'E' Hazardous Location Round Outlet Box	4	1	\$ 106.04
	GRE-0448	3/4" 1-Hub 'E' Hazardous Location Round Outlet Box	4	1	\$ 108.73
	GRE-0582	1" 1-Hub 'E' Hazardous Location Round Outlet Box	4	1	\$ 111.24
	GRE-0587	1¼" 1-Hub 'E' Hazardous Location Round Outlet Box	2	1	\$ 195.09
	GRE-0598	1½" 1-Hub 'E' Hazardous Location Round Outlet Box	2	1	\$ 416.58
	GRE-0603	2" 1-Hub 'E' Hazardous Location Round Outlet Box	2	1	\$ 443.86
	GRL-0439	1/2" 2-Hub 'LR/LL' Hazardous Location Round Outlet Box	4	1	\$ 111.18
	GRL-0440	3/4" 2-Hub 'LR/LL' Hazardous Location Round Outlet Box	4	1	\$ 118.45
	GRL-0546	1" 2-Hub 'LR/LL' Hazardous Location Round Outlet Box	4	1	\$ 123.54
	GRL-0591	1¼" 2-Hub 'LR/LL' Hazardous Location Round Outlet Box	2	1	\$ 208.61
	GRL-0558	1½" 2-Hub 'LR/LL' Hazardous Location Round Outlet Box	2	1	\$ 428.36
	GRL-0576	2" 2-Hub 'LR/LL' Hazardous Location Round Outlet Box	2	1	\$ 443.86
	GRT-0441	1/2" 3-Hub 'T' Hazardous Location Round Outlet Box	4	1	\$ 118.72
	GRT-0442	3/4" 3-Hub 'T' Hazardous Location Round Outlet Box	4	1	\$ 125.67
	GRT-0547	1" 3-Hub 'T' Hazardous Location Round Outlet Box	4	1	\$ 131.02
	GRT-0593	1¼" 3-Hub 'T' Hazardous Location Round Outlet Box	2	1	\$ 221.93
	GRT-0559	1½" 3-Hub 'T' Hazardous Location Round Outlet Box	2	1	\$ 455.88
	GRT-0578	2" 3-Hub 'T' Hazardous Location Round Outlet Box	2	1	\$ 471.93
	GRX-0449	1/2" 4-Hub 'X' Hazardous Location Round Outlet Box	4	1	\$ 123.54
	GRX-0450	3/4" 4-Hub 'X' Hazardous Location Round Outlet Box	4	1	\$ 132.95
	GRX-0585	1" 4-Hub 'X' Hazardous Location Round Outlet Box	4	1	\$ 145.37
	GRX-0595	1¼" 4-Hub 'X' Hazardous Location Round Outlet Box	2	1	\$ 237.03
	GRX-0601	1½" 4-Hub 'X' Hazardous Location Round Outlet Box	2	1	\$ 471.34
	GRX-0606	2" 4-Hub 'X' Hazardous Location Round Outlet Box	2	1	\$ 499.39
	GRXZ-0468	1/2" 5-Hub 'X+B' Hazardous Location Round Outlet Box	20	5	\$ 129.72
	GRXZ-0469	3/4" 5-Hub 'X+B' Hazardous Location Round Outlet Box	20	5	\$ 139.60
	GRXZ-0586	1" 5-Hub 'X+B' Hazardous Location Round Outlet Box	20	5	\$ 152.64
	GRXZ-0596	1¼" 5-Hub 'X+B' Hazardous Location Round Outlet Box	2	1	\$ 248.88
	GRXZ-0602	1½" 5-Hub 'X+B' Hazardous Location Round Outlet Box	2	1	\$ 494.91
	GRXZ-0607	2" 5-Hub 'X+B' Hazardous Location Round Outlet Box	2	1	\$ 524.36

Catalogue Number	Size Description	Packaging		LIST PRICE PER EACH
		Case	Box	

**Explosion Proof - Pressure Cast Aluminum - Epoxy Coated**

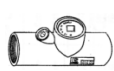

EYS-0452	1/2" Horiz/Vert Hazardous Location Sealing Fitting	20	5	\$	42.60
EYS-0453	3/4" Horiz/Vert Hazardous Location Sealing Fitting	20	5	\$	51.66
EYS-0550	1" Horiz/Vert Hazardous Location Sealing Fitting	20	5	\$	68.01
EYS-2633	1 1/4" Horiz/Vert Hazardous Location Sealing Fitting	10	2	\$	105.73
EYS-2634	1 1/2" Horiz/Vert Hazardous Location Sealing Fitting	5	1	\$	125.41
EYS-2635	2" Horiz/Vert Hazardous Location Sealing Fitting	5	1	\$	197.59

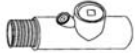

EYS-0452N	1/2" Horiz/Vert Hazardous Location Sealing Fitting W/Nipple	20	5	\$	42.60
EYS-0453N	3/4" Horiz/Vert Hazardous Location Sealing Fitting W/Nipple	20	5	\$	51.66
EYS-0550N	1" Horiz/Vert Hazardous Location Sealing Fitting W/Nipple	20	5	\$	68.01
EYS-2633N	1 1/4" Horiz/Vert Hazardous Location Sealing Fitting W/Nipple	10	2	\$	111.73
EYS-2634N	1 1/2" Horiz/Vert Hazardous Location Sealing Fitting W/Nipple	5	1	\$	125.41
EYS-2635N	2" Horiz/Vert Hazardous Location Sealing Fitting W/Nipple	5	1	\$	197.59



TA-2943	1/2" EYS Sealing Fitting Close Up Plug	100	25	\$	5.46
TA-2938	3/4" EYS Sealing Fitting Close Up Plug	100	25	\$	6.81
TA-2937	1" EYS Sealing Fitting Close Up Plug	80	20	\$	8.40
TA-2636	1 1/4" EYS Sealing Fitting Close Up Plug	80	2	\$	9.48
TA-2637	1 1/2" EYS Sealing Fitting Close Up Plug	40	2	\$	13.04
TA-2997	2" EYS Sealing Fitting Close Up Plug	40	1	\$	21.17







TU-2992	1/2" Hazardous Location Conduit Union	20	5	\$	29.05
TU-2993	3/4" Hazardous Location Conduit Union	20	5	\$	42.12
TU-2994	1" Hazardous Location Conduit Union	20	5	\$	71.30
TU-2995	1 1/4" Hazardous Location Conduit Union	10	2	\$	113.29
TU-2996	1 1/2" Hazardous Location Conduit Union	10	2	\$	146.84
TU-2997	2" Hazardous Location Conduit Union	5	1	\$	188.91

**STEEL - EXPLOSION-PROOF REDUCER BUSHINGS**



1161-HZ	3/4" X 1/2" Hazardous Location Reducing Bushing	100	25	\$	3.14
1162-HZ	1" X 1/2" Hazardous Location Reducing Bushing	100	25	\$	4.11
1163-HZ	1" X 3/4" Hazardous Location Reducing Bushing	80	20	\$	3.97
1164-HZ	1 1/4" X 1/2" Hazardous Location Reducing Bushing	80	20	\$	10.97
1165-HZ	1 1/4" X 3/4" Hazardous Location Reducing Bushing	80	20	\$	12.79
1166-HZ	1 1/4" X 1" Hazardous Location Reducing Bushing	50	10	\$	13.09
1167-HZ	1 1/2" X 1/2" Hazardous Location Reducing Bushing	50	10	\$	18.06
1168-HZ	1 1/2" X 3/4" Hazardous Location Reducing Bushing	50	10	\$	17.41
1169-HZ	1 1/2" X 1" Hazardous Location Reducing Bushing	50	10	\$	17.09
1170-HZ	1 1/2" X 1 1/4" Hazardous Location Reducing Bushing	50	10	\$	16.65
1171-HZ	2" X 1/2" Hazardous Location Reducing Bushing	50	10	\$	30.00
1172-HZ	2" X 3/4" Hazardous Location Reducing Bushing	50	10	\$	30.00
1173-HZ	2" X 1" Hazardous Location Reducing Bushing	50	10	\$	30.00
1174-HZ	2" X 1 1/4" Hazardous Location Reducing Bushing	50	10	\$	30.00
1175-HZ	2" X 1 1/2" Hazardous Location Reducing Bushing	50	10	\$	30.00

Catalogue Number	Size Description	Packaging		LIST PRICE PER EACH
		Case	Box	
<b>STEEL - EXPLOSION-PROOF UNIONS</b>				
	UNF-1S 1/2" Steel Hazardous Location Conduit Union F/F	20	5	\$ 19.13
	UNF-2S 3/4" Steel Hazardous Location Conduit Union F/F	20	5	\$ 25.95
	UNF-3S 1" Steel Hazardous Location Conduit Union F/F	20	5	\$ 47.17
				
	UNY-1S 1/2" Steel Hazardous Location Conduit Union M/F	10	2	\$ 20.57
	UNY-2S 3/4" Steel Hazardous Location Conduit Union M/F	5	1	\$ 29.45
	UNY-3S 1" Steel Hazardous Location Conduit Union M/F	5	1	\$ 50.16
	CE-2571 1 kg (2.2 Lb) Sealing Compound with 60g (2 oz) Fiber Kit	4	1	\$ 9,090.00
	FB-10 100g (3.52 Oz) Fiber	4	1	\$ 3,600.00



Weatherproof  
Products

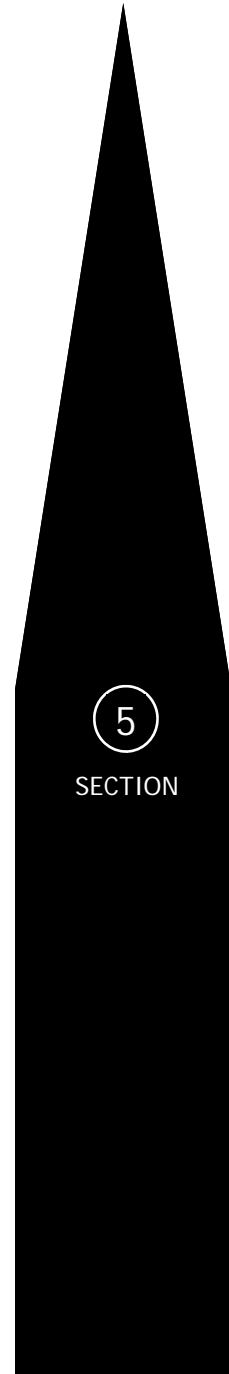

5

SECTION





August 1, 2010

Net Price Schedule:

**NE12-LIST**



Effective Date: August 1, 2010



Catalogue Number	Size / Description	Packaging		List Price
		Case	Box	
<b>Cast Aluminum Outlet Boxes</b>				
<b>1/2" Hub Regular 1-Gang Outlet Boxes</b>				
Colour: GRAY				
SB350S	1/2" 3-hole One Gang Outlet Box	-	16	\$ 965.00
SB450S	1/2" 4-hole One Gang Outlet Box	-	16	\$ 1,164.60
SB550S	1/2" 5-hole One Gang Outlet Box	-	16	\$ 1,190.00
Colour: WHITE				
 SB350WH	1/2" 3-hole One Gang Outlet Box	-	16	\$ 965.00
SB450WH	1/2" 4-hole One Gang Outlet Box	-	16	\$ 1,164.60
SB550WH	1/2" 5-hole One Gang Outlet Box	-	16	\$ 1,190.00
Colour: BRONZE				
SB350Z	1/2" 3-hole One Gang Outlet Box	-	16	\$ 965.00
SB450Z	1/2" 4-hole One Gang Outlet Box	-	16	\$ 1,164.60
SB550Z	1/2" 5-hole One Gang Outlet Box	-	16	\$ 1,190.00
Colour: GRAY				
SB100S	1" 3-hole One Gang Outlet Box	-	10	\$ 1,650.00
<b>3/4" Hub Regular 1-Gang Outlet Boxes</b>				
Colour: GRAY				
SB375S	3/4" 3-hole One Gang Outlet Box	-	10	\$ 1,046.00
SB475S	3/4" 4-hole One Gang Outlet Box	-	10	\$ 1,227.20
SB575S	3/4" 5-hole One Gang Outlet Box	-	10	\$ 1,252.00
Colour: WHITE				
 SB375WH	3/4" 3-hole One Gang Outlet Box	-	10	\$ 1,046.00
SB475WH	3/4" 4-hole One Gang Outlet Box	-	10	\$ 1,227.20
SB575WH	3/4" 5-hole One Gang Outlet Box	-	10	\$ 1,252.00
Colour: BRONZE				
SB375Z	3/4" 3-hole One Gang Outlet Box	-	10	\$ 1,046.00
SB475Z	3/4" 4-hole One Gang Outlet Box	-	10	\$ 1,227.20
SB575Z	3/4" 5-hole One Gang Outlet Box	-	10	\$ 1,252.00
Colour: GRAY - X-CONFIGURATION				
 SB550XS	1/2" 5-hole One Gang Outlet Box - X config.	-	10	\$ 1,252.00
SB575XS	3/4" 5-hole One Gang Outlet Box - X config.	-	10	\$ 1,252.00
<b>1" Hub Regular 1-Gang Outlet Boxes</b>				
Colour: GRAY				
 SB100S	1" 3-hole One Gang Outlet Box	-	10	\$ 2,063.60
<b>DEEP- Cast Aluminum Outlet Boxes</b>				
Colour: GRAY				
SD350S	1/2" 3-hole One Gang Outlet Box - DEEP	-	10	\$ 1,440.00
SD375S	3/4" 3-hole One Gang Outlet Box - DEEP	-	10	\$ 1,521.67
Colour: WHITE				
 SD350WH	1/2" 3-hole One Gang Outlet Box - DEEP	-	10	\$ 1,440.00
SD375WH	3/4" 3-hole One Gang Outlet Box - DEEP	-	10	\$ 1,521.67
Colour: BRONZE				
SD350Z	1/2" 3-hole One Gang Outlet Box - DEEP	-	10	\$ 1,440.00
SD375Z	3/4" 3-hole One Gang Outlet Box - DEEP	-	10	\$ 1,521.67
Colour: GRAY				
SD450S	1/2" 4-hole One Gang Outlet Box - DEEP	-	10	\$ 1,720.40
SD475S	3/4" 4-hole One Gang Outlet Box - DEEP	-	10	\$ 1,705.00

Prices are subject to change without notice.  
Minimum order = \$50.00

Tel: (905) 793-2218 Fax: (905) 793-2268  
www.nescocanada.com

	Catalogue Number	Size / Description	Packaging		List Price
			Case	Box	
<b>DOUBLE GANG - Cast Aluminum Outlet Boxes</b>					
	Colour: GRAY				
	DB350S	1/2" 3-hole Double Gang Outlet Box	-	9	\$ 1,820.00
	DB550S	1/2" 5-hole Double Gang Outlet Box	-	9	\$ 2,117.00
	Colour: WHITE				
	DB350WH	1/2" 3-hole Double Gang Outlet Box	-	9	\$ 1,820.00
	DB550WH	1/2" 5-hole Double Gang Outlet Box	-	9	\$ 2,117.00
	Colour: BRONZE				
	DB350Z	1/2" 3-hole Double Gang Outlet Box	-	9	\$ 1,820.00
	DB550Z	1/2" 5-hole Double Gang Outlet Box	-	9	\$ 2,117.00
	Colour: GRAY				
	DB375S	3/4" 3-hole Double Gang Outlet Box	-	9	\$ 2,160.00
	DB575S	3/4" 5-hole Double Gang Outlet Box	-	9	\$ 2,370.00
	Colour: WHITE				
	DB375WH	3/4" 3-hole Double Gang Outlet Box	-	9	\$ 2,160.00
	DB575WH	3/4" 5-hole Double Gang Outlet Box	-	9	\$ 2,370.00
	Colour: BRONZE				
	DB375Z	3/4" 3-hole Double Gang Outlet Box	-	9	\$ 2,160.00
	DB575Z	3/4" 5-hole Double Gang Outlet Box	-	9	\$ 2,370.00

Other configurations are available - Please check Taymac catalogue - Page 19, 20

**Metal Flat Single Gang Blank Cover**



BC100S	Gray	Single Gang Flat Cover	-	20	\$ 227.33
BC100WH	White	Single Gang Flat Cover	-	20	\$ 227.33
BC100Z	Bronze	Single Gang Flat Cover	-	20	\$ 227.33

**Metal Flat 2-Gang Blank Cover**



BC200S	Gray	Double Gang Flat Cover	-	20	\$ 443.67
BC200WH	White	Double Gang Flat Cover	-	20	\$ 443.67
BC200Z	Bronze	Double Gang Flat Cover	-	20	\$ 443.67

**Metal Flat 2-Gang Single Device Cover**



MX2150S		Flat 2-Gang 1-Device Cover	-	4	\$ 1,584.00
---------	--	----------------------------	---	---	-------------



**Toggle Switch Cover - Epoxy Coated**



TC100S		Single Gang Weatherproof Toggle Cover Includes Gasket and Mounting Hardware	-	10	\$ 982.00
--------	--	--	---	----	-----------



TC200S		2-Gang Toggle Cover Includes Gasket and Mounting Hardware	-	5	\$ 1,663.00
--------	--	--	---	---	-------------

Catalogue Number	Size / Description	Packaging		List Price
		Case	Box	

Cast Aluminum Weatherproof Covers - Epoxy Coated

Horizontal Double Door Weatherproof Duplex Receptacle



CH100S	Gray	Horizontal Duplex Receptacle Cover	-	20	\$	524.00
CH100WH	White	Horizontal Duplex Receptacle Cover	-	20	\$	524.00
CH100Z	Bronze	Horizontal Duplex Receptacle Cover	-	20	\$	524.00

Horizontal or Vertical Single Door Weatherproof 6-in-1 configuration



MX1250S	Horizontal or Vertical Cover	-	6	\$	640.00
---------	------------------------------	---	---	----	--------

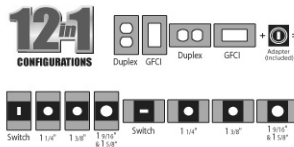

Vertical Weatherproof 6-in-1 Configuration



MX1050S	Vertical GFI Cover	-	6	\$	640.00
---------	--------------------	---	---	----	--------

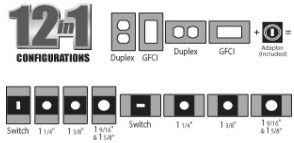

Double Gang Vertical Weatherproof 25-in-1 Configuration



MX2050S	Vertical Double Gang Weatherproof	-	8	\$	1,610.00
---------	-----------------------------------	---	---	----	----------

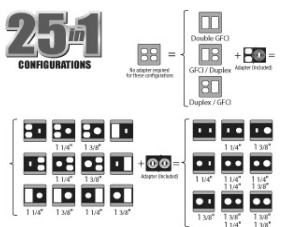

**Universal Fit™ Technology**

**ADAPTER**

Comes ready for duplex. For other configurations use needle-nose pliers to knock-out along grooves.

**(1) METAL BASE**

Base comes pre-configured for duplex installation, or knock-out for GFCI

**(2) KNOCK-OUT FOR ADAPTER**

Remove all knock-outs with needle nose pliers

**(3) ADAPTER**

Adapter is pre-configured for switch. Knock-out for rounds.

**(4) ADAPTER INSERTED**

Align adapter with the slots on the base, and snap into position.



Catalogue Number	Size / Description	Packaging		List Price
		Case	Box	

**METAL IN-USE COVERS**

→ Superior Commercial Quality Die Cast Metal → Construction Premium Powdercoat Finish  
 → Mounting Hardware, Gasket and Installation → Instructions Included Patented Universal-Fit™  
 → Technology Patented Quick-Fit™ Key Hole Mount for Easy Installation

**Double Gang 2-Device Cover - Commercial Quality Die-Cast Metal**



MX3200S	-	4	\$	33.37
Vertical 8-in-1 3.5" Depth				

**Double Gang 2-Device Cover - Commercial Quality Die-Cast Metal**







MX3300S	-	4	\$	33.37
Horizontal 8-in-1 3.5" Depth				

**Double Gang 2-Device Cover - Commercial Quality Die-Cast Metal**



MX6200S	-	4	\$	51.33
1 or 2 Device 55-in-1 3.5" Depth				

Catalogue Number	Size / Description	Packaging		List Price
		Case	Box	
<b>Plastic IN-USE Weatherproof Covers</b>				
	MM410C Single Gang- Clear Plastic Cover Horizontal / Vertical 2.75" Deep 16-in-1 Configurations with included snap-out template Complete with Gasket and Mounting Hardware	-	8	\$ 1,700.00
	MM2410C Double Gang - Clear Plastic Cover Horizontal / Vertical 2.75" Deep 16-in-1 Configurations with included snap-out template Complete with Gasket and Mounting Hardware	-	6	\$ 2,400.00
	ML400G Vertical Profile in-use cover Expands from 1" - 3½" Key Hole Mount for Easy Installation 100% Paintable surface Attached Gasket 8-in-1 Configuration with included snap out template	-	10	\$ 1,980.00
	ML450G Horizontal/Vertical Profile in-use cover Expands from 1" - 3½" Key Hole Mount for Easy Installation 100% Paintable surface Attached Gasket 16-in-1 Configuration with included snap out template	-	10	\$ 2,110.00

**ML400G**  
Cut-Away View



Closed











Expanded

Net Price Schedule:

**NE12-LIST**

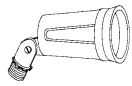











Effective Date: August 1, 2010



	Catalogue Number	Size / Description	Packaging		List Price	
			Case	Box		
<b>Round Cast Aluminum Outlet Boxes</b>						
	Colour: GRAY					
	RB550S	1/2"	4" Round Outlet Box c/w cover & gasket	-	13	\$ 1,077.00
	RB575S	3/4"	4" Round Outlet Box c/w cover & gasket	-	13	\$ 1,140.00
	Colour: WHITE					
	RB550WH	1/2"	4" Round Outlet Box c/w cover & gasket	-	13	\$ 1,077.00
	RB575WH	3/4"	4" Round Outlet Box c/w cover & gasket	-	13	\$ 1,140.00
	Colour: BRONZE					
	RB550Z	1/2"	4" Round Outlet Box c/w cover & gasket	-	13	\$ 1,077.00
	RB575Z	3/4"	4" Round Outlet Box c/w cover & gasket	-	13	\$ 1,140.00
<b>Round Cast Aluminum Lampholder Cover</b>						
	LV310S	1/2"	GRAY - 1-Hole Round Lampholder Cvr	-	20	\$ 481.94
	LV330Z	1/2"	BRONZE - 1-Hole Round Lampholder Cvr	-	10	\$ 481.94
	LV310Z	1/2"	WHITE - 1-Hole Round Lampholder Cvr	-	10	\$ 481.94
	LV330S	1/2"	GRAY - 3-Hole Round Lampholder Cvr	-	15	\$ 820.46
	LV330Z	1/2"	BRONZE - 3-Hole Round Lampholder Cvr	-	9	\$ 820.46
	LV330WH	1/2"	WHITE - 3-Hole Round Lampholder Cvr	-	9	\$ 820.46
<b>Round Blank Cover - Metal - Epoxy Coated</b>						
	BC300S		Round Blank Cover	-	20	\$ 313.00
<b>Closure Plugs for Cast Boxes</b>						
	CP5050S	1/2"	Threaded Closure Plugs	-	50	\$ 107.00
	CP5075S	3/4"	Threaded Closure Plugs	-	50	\$ 144.00
<b>Weatherproof Lampholder - Incandescent Lamp - Economy</b>						
	WPH-1G		Weatherproof Lampholder	-	25	\$ 592.90
<b>CAST ALUMINUM - Weatherproof Lampholder - Incandescent - Swivel Type</b>						
	LTS100S	Gray	Swivel Type - HALOGEN BULB	-	6	\$ 1,873.00
	LTS100WH	White	Swivel Type - HALOGEN BULB	-	6	\$ 1,873.00
	LTS100Z	Bronze	Swivel Type - HALOGEN BULB	-	6	\$ 1,873.00
<b>PLASTIC - Weatherproof Lampholder - Incandescent - Swivel Type</b>						
	PLTS100GY	Gray	Swive Type - Incandescent	-	6	\$ 688.82
	PLTS100WH	White	Swive Type - Incandescent	-	6	\$ 752.00
<b>CAST ALUMINUM - Weatherproof Lampholder - Halogen Lamp - Swivel Type</b>						
	LH100S	Gray	Swivel Type - HALOGEN BULB	-	6	\$ 1,873.00
	LHS100W	White	Swivel Type - HALOGEN BULB	-	6	\$ 1,873.00
	LHS100Z	Bronze	Swivel Type - HALOGEN BULB	-	6	\$ 1,873.00

Prices are subject to change without notice.  
Minimum order = \$50.00

Tel: (905) 793-2218 Fax: (905) 793-2268  
www.nescocanada.com

	Catalogue Number	Size / Description	Packaging		List Price	
			Case	Box		
<b>Vapourproof Fixtures</b>						
All fixtures are constructed in rugged Die Cast Aluminum, with medium base socket. Fixtures are available iwth 1/2" or 3/4" NPS perndant thread. All assembled fixtures include a clear heat resistant globe.						
		Thread Size				
*		VF1100W50	1/2" 100W Ceiling Mount Vapourproof Fixture	-	6	\$ 4,386.00
*		VF1100W50CG	1/2" 100W Ceiling Mount Vapourproof Fixture with cage	-	6	\$ 5,913.00
*		VF1100W75	3/4" 100W Ceiling Mount Vapourproof Fixture	-	6	\$ 4,484.00
*		VF1100W75CG	3/4" 100W Ceiling Mount Vapourproof Fixture with cage	-	6	\$ 5,913.00
*		VF1100W50CG	1/2" 100W Pendant Mount Vapourproof Fixture with cage	-	6	\$ 6,200.00
*		VFP100W75CG	3/4" 100W Pendant Mount Vapourproof Fixture with cage	-	6	\$ 7,400.00
		VFW100W50CG	1/2" 100W Wall Mount Vapourproof Fixture with cage	-	6	\$ 7,400.00
		VFW100W75CG	3/4" 100W Wall Mount Vapourproof Fixture with cage	-	6	\$ 2,350.00
		VFIBOX50	1/2" 4" 100W Vapourproof Fixture Mount	-	12	\$ 2,350.00
		VFIBOX75	3/4" 4" 100W Vapourproof Fixture Mount	-	12	\$ 2,350.00
		VFIGGC	- 7" Clear Plastic Globe	-	6	\$ 2,340.00
		VFIGLS	- 7" Vapourproof Clear Glass Globe	-	6	\$ 2,340.00
		VFICC	- 7" Vaporproof Cast Cage - Die Cast Aluminum	-	16	\$ 1,527.00

→ All assembled fixtures are equipped with 5 holes & available with 1/2" or 3/4" threaded holes

→ Socket with leads

→ Heat-resistant glass globe

→ Industrial grade, fully gasketed

→ For non-hazardous locations where the lamp, socket and wiring require protection from the rain, corrosive fumes, non-explosive vapors and gases

→ Approved for maximum 100W incandescent bulb













→ For lamp base up installation only when outdoors (\*)

Net Price Schedule:

**NE12-LIST**

Effective Date: August 1, 2010



	Catalogue Number	Size / Description	Packaging		List Price
			Case	Box	
<b>Taymac - Plastic Weatherproof Products</b>					
<b>Platic Rectangular Outlet Boxes - THREADED HUB - 3/4" Hub - 1/2" Reducers Included</b>					
	PSB37550GY	3/4", 1/2" Gray, 3-Hole Single Gang PVC Box 3 x 3/4"-1/2" reducer bushings included 2 x closure plugs	-	8	\$ 934.34
	PDB77550GY	3/4", 1/2" Gray, 7-hole Double Gang PVC Box 7 x 3/4"-1/2" reducer bushings included 6 x closure plugs	-	6	\$ 1,609.52
<b>1-Gang Rectangular Cover</b>					
	PBC100GY	Blank single gang cover	-	12	\$ 375.10
<b>2-Gang Rectangular Cover</b>					
	PBC200GY	Blank double gang cover	-	10	\$ 545.60
<b>Round Outlet Box - THREADED HUB - 3/4" Hub with 5 x 1/2" Threaded Reducers Included</b>					
	PRB57550GY	3/4", 1/2" Threaded Outlet Box 5 x 3/4"-1/2" reducer bushings included 4 x closure plugs included	-	8	\$ 934.34
<b>Round Blank Cover</b>					
	PBC300GY	Round Blank PVC Cover	-	10	\$ 426.25
<b>Round Lampholder Cover</b>					
	PLV330GY	1/2" Round 3-hole PVC lampholder cover 2 x closure plugs included	-	8	\$ 664.95
<b>Plastic Closure Plugs</b>					
	PCP47550GY	1/2" Threaded PVC Closure Plug	-	30	\$ 66.67
<b>Plastic Swivel Lampholder</b>					
	PLTS100GY	1/2" Multi-Directional Swivel Joing PVC Lampholder	-	12	\$ 688.82
<b>Weatherproof Switch Cover</b>					
	PTC100GY	Single gang toggle switch	-	8	\$ 678.59
	PTC200GY	Double gang, 2 x toggle switch	-	4	\$ 985.49
<b>Receptacle Cover &amp; Switch</b>					
	PTC521GY	Multi Configuration Receptacle Cover	-	4	\$ 1,346.95
					

Prices are subject to change without notice.  
Minimum order = \$50.00

Tel: (905) 793-2218 Fax: (905) 793-2268  
www.nescocanada.com

**IN STOCK...**

  
**AT NESCO**<sup>®</sup> INC.



### **Bridgeport # 1701-DC & 1702-DC Locknut-Less EMT Connectors**

Locknut-less zinc die cast EMT connectors from **Bridgeport Fittings** saves installation time while providing safe and secure attachment of 1/2" or 3/4" EMT. Designed to ease assembly of raceway where space is limited inside the box or locknut is difficult to tighten.

Simply tilt and snap the connector into the outlet box and insert the EMT conduit. Tightening the set screw causes the front of the connector to create wedging action against the knockout hole for a tight fit.

**It's faster and more profitable in every way.**

Free sample  
available through:

  
**NESCO**<sup>®</sup> INC.

Call 1 (866) 446-3726

Or email your request to:  
[info@nescocanada.com](mailto:info@nescocanada.com)





Bport.1701.1702-connectors

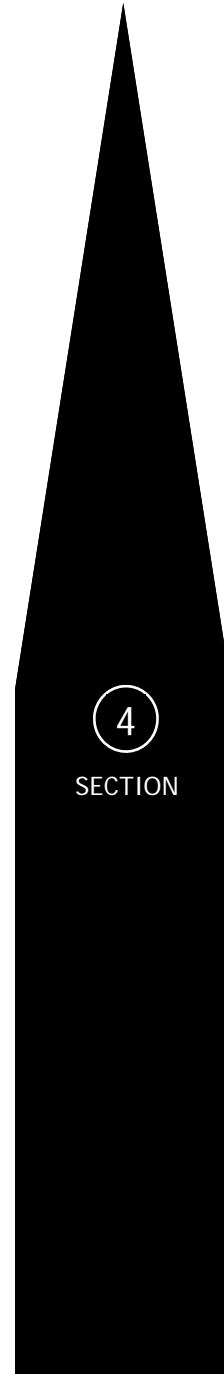



Signaling &  
Switches

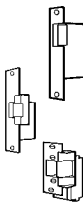

August 1, 2010

	Catalogue Number	Dimensions & Description	Box Qty.		LIST Price PER EACH	
<b>Bells &amp; Buzzers</b>						
	437-4-6	Alarm Bell, 4" Gray Gong, 6 VDC	1	\$	93.95	
	437-4R-6	Alarm Bell, 4" Red Gong, 6 VDC	1	\$	93.95	
	437-4-12	Alarm Bell, 4" Gray Gong, 12 VDC	1	\$	93.95	
	437-4R-12	Alarm Bell, 4" Red Gong, 12 VDC	1	\$	93.95	
	437-4-24	Alarm Bell, 4" Gray Gong, 24 VDC	1	\$	93.95	
	437-4R-24	Alarm Bell, 4" Red Gong, 24 VDC	1	\$	93.95	
	437-4-120	Alarm Bell, 4" Gray Gong, 120 VAC	1	\$	93.95	
	437-4R-120	Alarm Bell, 4" Red Gong, 120 VAC	1	\$	93.95	
	437-6-6	Alarm Bell, 6" Gray Gong, 6 VDC	1	\$	112.36	
	437-6R-6	Alarm Bell, 6" Red Gong, 6 VDC	1	\$	112.36	
437-6-12	Alarm Bell, 6" Gray Gong, 12 VDC	1	\$	112.36		
437-6R-12	Alarm Bell, 6" Red Gong, 12 VDC	1	\$	112.36		
437-6-24	Alarm Bell, 6" Gray Gong, 24 VDC	1	\$	112.36		
437-6R-24	Alarm Bell, 6" Red Gong, 24 VDC	1	\$	112.36		
437-6-120	Alarm Bell, 6" Gray Gong, 120 VAC	1	\$	112.36		
437-6R-120	Alarm Bell, 6" Red Gong, 120 VAC	1	\$	112.36		
437-8-6	Alarm Bell, 8" Gray Gong, 6 VDC	1	\$	124.34		
437-8R-6	Alarm Bell, 8" Red Gong, 6 VDC	1	\$	124.34		
437-8-12	Alarm Bell, 8" Gray Gong, 12 VDC	1	\$	124.34		
437-8R-12	Alarm Bell, 8" Red Gong, 12 VDC	1	\$	124.34		
437-8-24	Alarm Bell, 8" Gray Gong, 24 VDC	1	\$	124.34		
437-8R-24	Alarm Bell, 8" Red Gong, 24 VDC	1	\$	124.34		
437-8-120	Alarm Bell, 8" Gray Gong, 120 VAC	1	\$	124.34		
437-8R-120	Alarm Bell, 8" Red Gong, 120 VAC	1	\$	124.34		
437-10-6	Alarm Bell, 10" Gray Gong, 6 VDC	1	\$	132.63		
437-10R-6	Alarm Bell, 10" Red Gong, 6 VDC	1	\$	132.63		
437-10-12	Alarm Bell, 10" Gray Gong, 12 VDC	1	\$	132.63		
437-10R-12	Alarm Bell, 10" Red Gong, 12 VDC	1	\$	132.63		
437-10-24	Alarm Bell, 10" Gray Gong, 24 VDC	1	\$	132.63		
437-10R-24	Alarm Bell, 10" Red Gong, 24 VDC	1	\$	132.63		
437-10-120	Alarm Bell, 10" Gray Gong, 120 VAC	1	\$	132.63		
437-10R120	Alarm Bell, 10" Red Gong, 120 VAC	1	\$	132.63		
	GP-501	General Purpose Fully Enclosed Bell, 3 - 6VDC; 8-16VAC	1	\$	16.58	
	GP-502	General Purpose Fully Enclosed Buzzer, 3 - 6VDC; 8-16VAC	1	\$	11.51	
	GP-503	General Purpose Fully Enclosed Bell & Buzzer, 3 - 6VDC; 8-16VAC	1	\$	17.68	
		GP-504	General Purpose Bell, 2 1/2" Gong, 3 - 6VDC; 8-16VAC 60 Hz	1	\$	14.27
		GP-505	General Purpose Bell, 4" Gong, 3 - 6VDC; 8-16VAC 60 Hz	1	\$	17.87
<b>Chimes and Chime Kits</b>						
	C-202W	White Chime w/ 16V XFRM and 2 Unlighted Buttons - <b>24 Pack</b>	24	\$	14.74	
	C-202WL	White Chime w/ 16V XFRM and 2 Lighted Buttons - <b>24 Pack</b>	24	\$	23.03	
	C-201WS	White Chime w/ 16V XFRM and 1 Unlighted Stucco Button - <b>24 Pack</b>	24	\$	16.58	
	C-201WSL	White Chime w/ 16V XFRM and 1 Lighted Stucco Button - <b>24 Pack</b>	24	\$	20.72	
	C-200W	White Chime Only - <b>24 Pack</b>	24	\$	11.05	
<b>Electric Door Openers</b>						
	DS-101B	Mortise Type, Adjustable Latch, For Wood & Metal Jambs, Brass Face	1	\$	55.27	
	DS-101C	Mortise Type, Adjustable Latch, For Wood & Metal Jambs, Chrome Face	1	\$	55.27	
	DS-102S	Mortise Type, Adjustable Latch, For Wood & Alum Jambs, Silver Face	1	\$	82.90	
	DS-103B	Mortise Type, Adjustable Latch, For Hollow Metal Jambs, Brass Face	1	\$	119.74	
	DS-103C	Mortise Type, Adjustable Latch, For Hollow Metal Jambs, Chrome Face	1	\$	119.74	

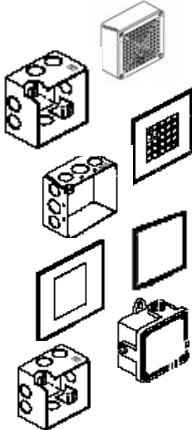
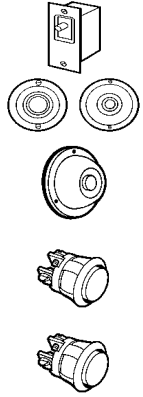
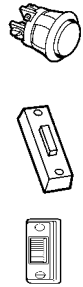

	Catalogue Number	Dimensions & Description	Box Qty.	List Price
<b>Horns and Accessories</b>				
	B-874-120	120V Vibrating Horn 120VAC	1	\$ 127.10
	B-876-120	120V Vibrating Horn Weatherproof 120VAC	1	\$ 190.66
	B-FMBX	Deep Flush Mount Masonary Box	1	\$ 95.33
	B-FGPL	Flush Grill Plate	1	\$ 19.34
	B-INTBX	Interior Gray Box	1	\$ 12.71
	B-MGSK	Mounting Gasket Kit	1	\$ 8.47
	B-SFPL	Semi-flush Gray Plate	1	\$ 19.34
	B-WPBX	Weatherproof Box	1	\$ 44.67
	B-WMBX	Wall Mount Box	1	\$ 63.56
	<b>Push Buttons and Switches</b>			
	PB-301	Door Light Switch, Gold Plate, 120VAC, N/O & N/C	1	\$ 15.65
	PB-301N	Narrow Frame Door Light Switch, Gold Plate, 120VAC, N/O & N/C	1	\$ 18.43
	PB-302	Solid Brass Unlighted Push Button, 2-1/4" Dia, Black Ctr	10	\$ 5.07
	PB-303	Solid Brass Unlighted Push Button, 1-3/4" Dia, Black Ctr	10	\$ 4.60
	PB-304	Solid Brass Unlighted Weatherproof Push Button	1	\$ 49.73
	PB-305B	Flush Low Voltage 5/8". Brass Finish. Unlighted.	10	\$ 4.14
	PB-305C	Flush Low Voltage 5/8". Chrome Finish. Unlighted.	10	\$ 4.14
	PB-305BL	Flush Low Voltage 5/8". Brass Finish. Lighted	10	\$ 8.11
	PB-305CL	Flush Low Voltage 5/8". Chrome Finish. Lighted	10	\$ 8.11
	<b>Push Buttons and Switches</b>			
	PB-306C	Same as PB-305C but Bulk Packed - 500 Pieces	1	\$ <u>500 piece box</u> 1381.54
	PB-306B	Same as PB-305B but Bulk Packed - 500 Pieces	1	\$ <u>1381.54</u>
	PB-307GL	Gold Plastic, White Center Push Button, Lighted	10	\$ 8.11
	PB-307WL	White Plastic, White Center Push Button, Lighted	10	\$ 8.11
	PB-307W	White Plastic, White Center Push Button, Unlighted	10	\$ 4.42
	PB-308BL	Aluminum Brass Anodized, White Center Push Button, Lightec	10	\$ 9.49
	PB-308CL	Aluminum Chrome Anodized, White Center Push Button, Lightec	10	\$ 9.49
	<b>Transformers</b>			
	T-601	120VAC Pri, 16VAC 10VA Sec, Locknut	20	\$ 14.36
	T-602	120VAC Pri, 8/16VAC 10VA; 24VAC 20VA Sec, Clamp-on	20	\$ 18.05
	T-603	120VAC Pri, 8/16VAC 20VA; 24VAC 30VA Sec, Clamp-on	20	\$ 20.81
	T-604	120VAC Pri, 24VAC 40VA Secondary, Clamp-on	20	\$ 21.74

Catalogue Number	Dimensions & Description	Box Qty.	List Price
------------------	--------------------------	----------	------------

**Visual Signals - Flashing Beacons**

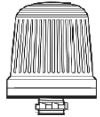

Two mounting options:  
 -Surface and 1/2"  
 conduit

802-IFA24	Amber Flashing Incandescent, 24VDC	1	\$ 58.94
802-IFB24	Blue Flashing Incandescent, 24VDC	1	\$ 58.94
802-IFC24	Clear Flashing Incandescent, 24VDC	1	\$ 58.94
802-IFG24	Green Flashing Incandescent, 24VDC	1	\$ 58.94
802-IFR24	Red Flashing Incandescent, 24VDC	1	\$ 58.94
802-IFA120	Amber Flashing Incandescent, 120VAC	1	\$ 58.94
802-IFB120	Blue Flashing Incandescent, 120VAC	1	\$ 58.94
802-IFC120	Clear Flashing Incandescent, 120VAC	1	\$ 58.94
802-IFG120	Green Flashing Incandescent, 120VAC	1	\$ 58.94
802-IFR120	Red Flashing Incandescent, 120VAC	1	\$ 58.94

**Visual Signals - Rotating Beacons**

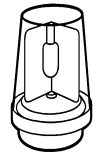

B-52A-120	Amber Rotating Beacon, Weatherproof, Type 4X, 120VAC	1	\$ 211.84
B-52B-120	Blue Rotating Beacon, Weatherproof, Type 4X, 120VAC	1	\$ 211.84
B-52C-120	Clear Rotating Beacon, Weatherproof, Type 4X, 120VAC	1	\$ 211.84
B-52G-120	Green Rotating Beacon, Weatherproof, Type 4X, 120VAC	1	\$ 211.84
B-52R-120	Red Rotating Beacon, Weatherproof, Type 4X, 120VAC	1	\$ 211.84
700-RA24	Amber Rotating Beacon, Indoor Use, 24VAC	1	\$ 182.37
700-RB24	Blue Rotating Beacon, Indoor Use, 24VAC	1	\$ 182.37
700-RC24	Clear Rotating Beacon, Indoor Use, 24VAC	1	\$ 182.37
700-RG24	Green Rotating Beacon, Indoor Use, 24VAC	1	\$ 182.37
700-RR24	Red Rotating Beacon, Indoor Use, 24VAC	1	\$ 182.37
700-RA120	Amber Rotating Beacon, Indoor Use, 120VAC	1	\$ 182.37
700-RB120	Blue Rotating Beacon, Indoor Use, 120VAC	1	\$ 182.37
700-RC120	Clear Rotating Beacon, Indoor Use, 120VAC	1	\$ 182.37
700-RG120	Green Rotating Beacon, Indoor Use, 120VAC	1	\$ 182.37
700-RR120	Red Rotating Beacon, Indoor Use, 120VAC	1	\$ 182.37

**Visual Signals - Steady Beacons**



Two mounting options:  
 -Surface and 1/2"  
 conduit

801-ISA24	Amber Steady Incandescent, 24VDC	1	\$ 55.27
801-ISB24	Blue Steady Incandescent, 24VDC	1	\$ 55.27
801-ISC24	Clear Steady Incandescent, 24VDC	1	\$ 55.27
801-ISG24	Green Steady Incandescent, 24VDC	1	\$ 55.27
801-ISR24	Red Steady Incandescent, 24VDC	1	\$ 55.27
801-ISA120	Amber Steady Incandescent, 120VAC	1	\$ 55.27
801-ISB120	Blue Steady Incandescent, 120VAC	1	\$ 55.27
801-ISC120	Clear Steady Incandescent, 120VAC	1	\$ 55.27
801-ISG120	Green Steady Incandescent, 120VAC	1	\$ 55.27
801-ISR120	Red Steady Incandescent, 120VAC	1	\$ 55.27

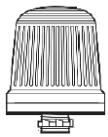
Catalogue Number	Dimensions & Description	Box Qty.	List Price
<b>Visual Signals - Strobe Lights</b>			
800-STA24	Amber Strobe, Low Profile, 24VDC	1	\$ 62.63
800-STB24	Blue Strobe, Low Profile, 24VDC	1	\$ 62.63
800-STC24	Clear Strobe, Low Profile, 24VDC	1	\$ 62.63
800-STG24	Green Strobe, Low Profile, 24VDC	1	\$ 62.63
800-STR24	Red Strobe, Low Profile, 24VDC	1	\$ 62.63
800-STA120	Amber Strobe, Low Profile, 120VAC	1	\$ 62.63
800-STB120	Blue Strobe, Low Profile, 120VAC	1	\$ 62.63
800-STC120	Clear Strobe, Low Profile, 120VAC	1	\$ 62.63
800-STG120	Green Strobe, Low Profile, 120VAC	1	\$ 62.63
800-STR120	Red Strobe, Low Profile, 120VAC	1	\$ 62.63
			
Two mounting options: -Surface and 1/2" conduit			
840P-SA18	Amber Strobe, Low Profile, Pipe Mount, 12-48VDC	1	\$ 113.47
840P-SB18	Blue Strobe, Low Profile, Pipe Mount, 12-48VDC	1	\$ 113.47
840P-SC18	Clear Strobe, Low Profile, Pipe Mount, 12-48VDC	1	\$ 113.47
840P-SG18	Green Strobe, Low Profile, Pipe Mount, 12-48VDC	1	\$ 113.47
840P-SR18	Red Strobe, Low Profile, Pipe Mount, 12-48VDC	1	\$ 113.47
840P-SA120	Amber Strobe, Low Profile, Pipe Mount, 120VAC	1	\$ 113.47
840P-SB120	Blue Strobe, Low Profile, Pipe Mount, 120VAC	1	\$ 113.47
840P-SC120	Clear Strobe, Low Profile, Pipe Mount, 120VAC	1	\$ 113.47
840P-SG120	Green Strobe, Low Profile, Pipe Mount, 120VAC	1	\$ 113.47
840P-SR120	Red Strobe, Low Profile, Pipe Mount, 120VAC	1	\$ 113.47
840T-SA18	Amber Strobe, Low Profile, "T" Mount, 12-48VDC	1	\$ 113.47
840T-SB18	Blue Strobe, Low Profile, "T" Mount, 12-48VDC	1	\$ 113.47
840T-SC18	Clear Strobe, Low Profile, "T" Mount, 12-48VDC	1	\$ 113.47
840T-SG18	Green Strobe, Low Profile, "T" Mount, 12-48VDC	1	\$ 113.47
840T-SR18	Red Strobe, Low Profile, "T" Mount, 12-48VDC	1	\$ 113.47
840T-SA120	Amber Strobe, Low Profile, "T" Mount, 120VAC	1	\$ 113.47
840T-SB120	Blue Strobe, Low Profile, "T" Mount, 120VAC	1	\$ 113.47
840T-SC120	Clear Strobe, Low Profile, "T" Mount, 120VAC	1	\$ 113.47
840T-SG120	Green Strobe, Low Profile, "T" Mount, 120VAC	1	\$ 113.47
840T-SR120	Red Strobe, Low Profile, "T" Mount, 120VAC	1	\$ 113.47

**Replacement Parts**

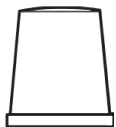

700-RLA	Replacement Amber Dome 700 Series	1	\$ 38.44
700-RLB	Replacement Blue Dome 700 Series	1	\$ 38.44
700-RLC	Replacement Clear Dome 700 Series	1	\$ 38.44
700-RLG	Replacement Green Dome 700 Series	1	\$ 38.44
700-RLR	Replacement Red Dome 700 Series	1	\$ 38.44



800-LA	Replacement Amber Lens 800 Series	1	\$ 24.99
800-LB	Replacement Blue Lens 800 Series	1	\$ 24.99
800-LC	Replacement Clear Lens 800 Series	1	\$ 24.99
800-LG	Replacement Green Lens 800 Series	1	\$ 24.99
800-LR	Replacement Red Lens 800 Series	1	\$ 24.99



800-ST	Replacement Strobe Tube 800 Series	1	\$ 21.14
--------	------------------------------------	---	----------



B-52-LA	Replacement Amber Dome B-52 Series	1	\$ 34.59
B-52-LB	Replacement Blue Dome B-52 Series	1	\$ 34.59
B-52-LC	Replacement Clear Dome B-52 Series	1	\$ 34.59
B-52-LG	Replacement Green Dome B-52 Series	1	\$ 34.59
B-52-LR	Replacement Red Dome B-52 Series	1	\$ 34.59



K149123A	Replacement Bulb B-52 Series	1	\$ 11.53
----------	------------------------------	---	----------

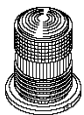

840-LA	Replacement Amber Lens 840 Series	1	\$ 19.23
840-LB	Replacement Blue Lens 840 Series	1	\$ 19.23
840-LC	Replacement Clear Lens 840 Series	1	\$ 19.23
840-LG	Replacement Green Lens 840 Series	1	\$ 19.23
840-LR	Replacement Red Lens 840 Series	1	\$ 19.23



K149130A	Replacement Strobe Tube 840 Series	1	\$ 36.52
----------	------------------------------------	---	----------

**IN STOCK...**

  
**AT NESCO**



COMBINATION  
 EMT/RIGID TO EMT/RIGID  
 AND  
 EMT/RIGID TO BOX  
 PULL ELBOW



Catalogue Number	Trade Size	Packaging		List Price per 100
		Box	Case	
<b>EMT / RIGID to BOX - ALUMINUM</b>				
71-DCA	1/2"	10	60	\$ 825.00
72-DCA	3/4"	10	60	\$ 1,352.00
<b>EMT / RIGID to EMT / RIGID - ALUMINUM</b>				
81-DCA	1/2"	10	60	\$ 861.08
82-DCA	3/4"	10	60	\$ 1,458.00
83-DCA	1"	5	25	\$ 3,083.00
84-DCA	1 1/4"	5	20	\$ 3,654.00

- \* COMBINATION TYPE PULL ELBOWS COMPLETE WITH ALUMINUM COVER AND NEOPRENE GASKET
- \* THREADED FOR USE WITH RIGID OR IMC , SET-SCREWS FOR USE WITH EMT
- \* TRI-COMBO SCREWS USED ON CODUIT BODY AND COVER
- \* PREASSEMBLED WITH COVER AND GASKET
- \* REDUCES INVENTORY - REPLACES INDIVIDUAL SKU'S FOR RIGID AND EMT

COMBINATION.PULLELBOWS.D 10809

\* Prices are in Canadian Dollars, F.O.B. Nesco Inc. warehouse.  
 \* Prices are subject to change without notice.



PVC, DBII & ENT  
Conduit & Fittings

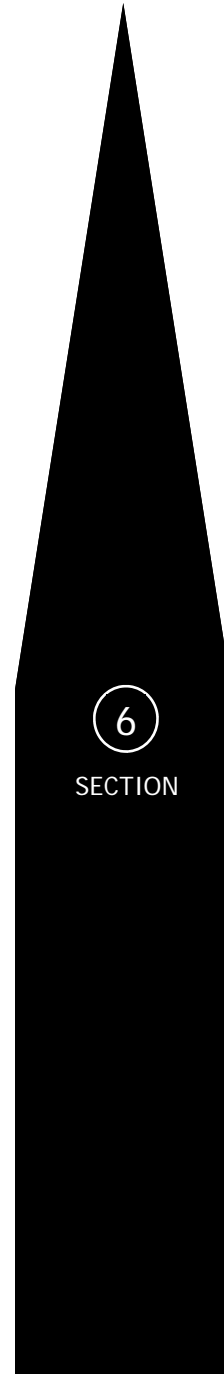

August 1, 2010

Catalogue Number	Alternate Number	Trade Size	Packaging		List Price
			Case	Box	
<b>Rigid PVC Conduit</b>			<u>CRATE</u>	<u>BUNDLE</u>	
CON10005		1/2"	6000'	100'	\$ 136.00
CON10007		3/4"	4400'	100'	\$ 171.00
CON10010		1"	3600'	100'	\$ 255.00
CON10012		1-1/4"	3300'	50'	\$ 322.00
CON10015		1-1/2"	2250'	50'	\$ 431.00
CON10020		2"	1400'	50'	\$ 540.00
CON10025		2½"	780'	10'	\$ 935.00
CON10030		3"	780'	10'	\$ 1,228.00
CON10035		3½"	630'	10'	\$ 1,543.00
CON10040		4"	600'	10'	\$ 1,738.00
CON10050		5"	230'	10'	\$ 2,475.00
CON10060		6"	260'	10'	\$ 3,289.00

**Coupling**



EC10	CP05	½ "	-	150	\$ 118.00
EC15	CP07	¾ "	-	100	\$ 156.00
EC20	CP10	1 "	-	50	\$ 211.00
EC25	CP12	1¼ "	-	50	\$ 276.00
EC30	CP15	1½ "	-	25	\$ 376.00
EC35	CP20	2 "	-	40	\$ 522.00
EC40	CP25	2½ "	-	20	\$ 1,071.00
EC45	CP30	3 "	-	30	\$ 1,379.00
EC50	CP35	3½ "	-	20	\$ 1,810.00
EC55	CP40	4 "	-	20	\$ 1,936.00
EC60	CP50	5 "	-	10	\$ 5,279.00
EC65	CP60	6 "	-	5	\$ 6,060.00

**Terminal Adapter**

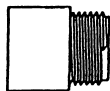



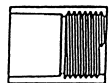

TA10	TA05	½ "	-	200	\$ 137.00
TA15	TA07	¾ "	-	150	\$ 235.00
TA20	TA10	1 "	-	100	\$ 258.00
TA25	TA12	1¼ "	-	50	\$ 276.00
TA30	TA15	1½ "	-	30	\$ 499.00
TA35	TA20	2 "	-	50	\$ 483.00
TA40	TA25	2½ "	-	25	\$ 1,305.00
TA45	TA30	3 "	-	50	\$ 1,553.00
TA50	TA35	3½ "	-	30	\$ 3,025.00
TA55	TA40	4 "	-	30	\$ 2,946.00
TA60	TA50	5 "	-	12	\$ 6,495.00
TA65	TA60	6 "	-	10	\$ 7,444.00

**Female Adapter**



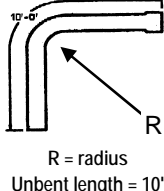





FA10	FA05	½ "	-	150	\$ 162.00
FA15	FA07	¾ "	-	100	\$ 264.00
FA20	FA10	1 "	-	50	\$ 338.00
FA25	FA12	1¼ "	-	30	\$ 399.00
FA30	FA15	1½ "	-	25	\$ 520.00
FA35	FA20	2 "	-	30	\$ 735.00
FA40	FA25	2½ "	-	20	\$ 1,305.00
FA45	FA30	3 "	-	25	\$ 1,876.00
FA50	FA35	3½ "	-	20	\$ 3,025.00
FA55	FA40	4 "	-	15	\$ 2,946.00
FA60	FA50	5 "	-	10	\$ 6,495.00
FA65	FA60	6 "	-	6	\$ 7,444.00

	Catalogue Number	Alternate Number	Trade Size	Packaging Case	Box	List Price
<b>90° Elbow</b>						
	EE1090	40STD0590	½ "	-	40	\$ 360.00
	EE1590	40STD0790	¾ "	-	40	\$ 416.00
	EE2090	40STD1090	1 "	-	40	\$ 640.00
	EE2590	40STD1290	1¼ "	-	20	\$ 903.00
	EE3090	40STD1590	1½ "	-	20	\$ 1,277.00
	EE3590	40STD2090	2 "	-	15	\$ 1,897.00
	EE4090	40STD2590	2½ "	-	1	\$ 4,156.00
	EE4590	40STD3090	3 "	-	1	\$ 6,822.00
	EE5090	40STD3590	3½ "	-	1	\$ 9,348.00
	EE5590	40STD4090	4 "	-	1	\$ 11,112.00
	EE6090	40STD5090	5 "	-	1	\$ 41,220.00
	EE6590	40STD6090	6 "	-	1	\$ 66,550.00
<b>45° Elbow</b>						
	EE1045	40STD0545	½ "	-	75	\$ 388.00
	EE1545	40STD0745	¾ "	-	25	\$ 445.00
	EE2045	40STD1045	1 "	-	20	\$ 693.00
	EE2545	40STD1245	1¼ "	-	30	\$ 977.00
	EE3045	40STD1545	1½ "	-	15	\$ 1,310.00
	EE3545	40STD2045	2 "	-	10	\$ 2,052.00
	EE4045	40STD2545	2½ "	-	1	\$ 4,156.00
	EE4545	40STD3045	3 "	-	1	\$ 7,004.00
	EE5045	40STD3545	3½ "	-	1	\$ 9,348.00
	EE5545	40STD4045	4 "	-	1	\$ 11,405.00
	EE6045	40STD5045	5 "	-	1	\$ 41,220.00
	EE6545	40STD6045	6 "	-	1	\$ 66,550.00
<b>30° Elbow</b>						
	EE1030	40STD0530	½ "	-	1	\$ 388.00
	EE1530	40STD0730	¾ "	-	1	\$ 445.00
	EE2030	40STD1030	1 "	-	1	\$ 693.00
	EE2530	40STD1230	1¼ "	-	1	\$ 977.00
	EE3030	40STD1530	1½ "	-	1	\$ 1,310.00
	EE3530	40STD2030	2 "	-	1	\$ 2,052.00
	EE4030	40STD2530	2½ "	-	1	\$ 4,156.00
	EE4530	40STD3030	3 "	-	1	\$ 7,004.00
	EE5030	40STD3530	3½ "	-	1	\$ 9,348.00
	EE5530	40STD4030	4 "	-	1	\$ 11,405.00
	EE6030	40STD5030	5 "	-	1	\$ 41,220.00
	EE6530	40STD6030	6 "	-	1	\$ 66,550.00
<b>90° Utility Bend</b>						
	NSL2-24	UB2-24	2" x 24" R	-	1	\$ 14,123.00
	NSL2-36	UB2-36	2" x 36" R	-	1	\$ 14,240.00
	NSL3-24	UB3-24	3" x 24" R	-	1	\$ 11,235.00
	NSL3-36	UB3-36	3" x 36" R	-	1	\$ 17,924.00
	NSL4-36	UB4-36	4" x 36" R	-	1	\$ 24,740.00
	NSL4-48	UB4-48	4" x 48" R	-	1	\$ 28,346.00
	NSL5-36	UB5-36	5" x 36" R	-	1	\$ 41,220.00
NSL6-36	UB6-36	6" x 36" R	-	1	\$ 66,550.00	
<b>5° Coupling</b>						
	5EC35	5CP20	2 "	-	15	\$ 948.00
	5EC40	5CP25	2½ "	-	12	\$ 1,642.00
	5EC45	5CP30	3 "	-	10	\$ 2,140.00
	5EC50	5CP35	3½ "	-	15	\$ 4,071.00
	5EC55	5CP40	4 "	-	15	\$ 4,079.00
	5EC60	5CP50	5 "	-	4	\$ 6,518.00
	5EC65	5CP60	6 "	-	6	\$ 6,518.00







**NE12-LIST**





Effective Date: August 1, 2010



	Catalogue Number	Alternate Number	Trade Size	Packaging Case	Box	List Price
<b>Pull-elbow</b>						
	PE15/10	PPE-05	½ "	-	75	\$ 604.00
	PE15/10	PPE-07	¾ "	-	50	\$ 604.00
<b>C-Fitting</b>						
	SC10S	C05	½ "	-	30	\$ 1,337.00
	SC20S	C07	¾ "	-	20	\$ 865.00
	SC30S	C10	1 "	-	15	\$ 1,029.00
	SC40S	C12	1¼ "	-	15	\$ 1,853.00
	SC50S	C15	1½ "	-	10	\$ 1,879.00
	SC60S	C20	2 "	-	15	\$ 3,655.00
	SC70S	C25	2½ "	-	4	\$ 11,429.00
	SC80S	C30	3 "	-	4	\$ 11,429.00
	SC90S	C35	3½ "	-	4	\$ 19,808.00
	SC100S	C40	4 "	-	4	\$ 19,808.00
<b>E-Fitting</b>						
	SE10S	E05	½ "	-	30	\$ 704.00
	SE20S	E07	¾ "	-	20	\$ 830.00
	SE30S	E10	1 "	-	15	\$ 1,056.00
	SE40S	E12	1¼ "	-	20	\$ 1,739.00
	SE50S	E15	1½ "	-	10	\$ 2,206.00
	SE60S	E20	2 "	-	15	\$ 3,655.00
	SE70S	E25	2½ "	-	4	\$ 11,426.00
	SE80S	E30	3 "	-	4	\$ 11,426.00
	SE90S	E35	3½ "	-	4	\$ 19,808.00
	SE100S	E40	4 "	-	4	\$ 19,808.00
<b>LB-Fitting</b>						
	SLB10S	LB05	½ "	-	25	\$ 677.00
	SLB20S	LB07	¾ "	-	25	\$ 779.00
	SLB30S	LB10	1 "	-	15	\$ 1,016.00
	SLB40S	LB12	1¼ "	-	20	\$ 1,679.00
	SLB50S	LB15	1½ "	-	10	\$ 2,206.00
	SLB60S	LB20	2 "	-	15	\$ 3,516.00
	SLB70S	LB25	2½ "	-	5	\$ 11,395.00
	SLB80S	LB30	3 "	-	5	\$ 11,395.00
	SLB90S	LB35	3½ "	-	5	\$ 19,808.00
	SLB100S	LB40	4 "	-	5	\$ 19,808.00
<b>LL-Fitting</b>						
	SLL10S	LL05	½ "	-	25	\$ 746.00
	SLL20S	LL07	¾ "	-	20	\$ 811.00
	SLL30S	LL10	1 "	-	15	\$ 1,363.00
	SLL40S	LL12	1¼ "	-	10	\$ 1,853.00
	SLL50S	LL15	1½ "	-	10	\$ 2,658.00
	SLL60S	LL20	2 "	-	10	\$ 4,438.00
	SLL70S	LL25	2½ "	-	4	\$ 11,429.00
	SLL80S	LL30	3 "	-	4	\$ 11,429.00
	SLL90S	LL35	3½ "	-	5	\$ 19,808.00
	SLL100S	LL40	4 "	-	5	\$ 19,808.00
<b>LR-Fitting</b>						
	SLR10S	LR05	½ "	-	25	\$ 746.00
	SLR20S	LR07	¾ "	-	20	\$ 811.00
	SLR30S	LR10	1 "	-	15	\$ 1,363.00
	SLR40S	LR12	1¼ "	-	10	\$ 1,853.00
	SLR50S	LR15	1½ "	-	10	\$ 2,658.00
	SLR60S	LR20	2 "	-	10	\$ 4,438.00
	SLR70S	LR25	2½ "	-	4	\$ 11,429.00
	SLR80S	LR30	3 "	-	4	\$ 11,429.00
	SLR90S	LR35	3½ "	-	5	\$ 19,808.00
	SLR100S	LR40	4 "	-	5	\$ 19,808.00



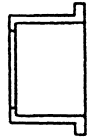

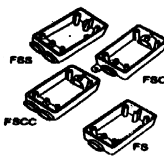
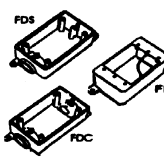
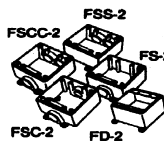
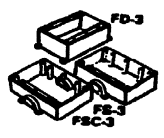
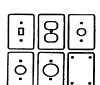

	Catalogue Number	Alternate Number	Trade Size	Packaging Case	Box	List Price
<b>T-Fitting</b>						
	ST10S	T05	½ "	-	30	\$ 1,253.00
	ST20S	T07	¾ "	-	20	\$ 838.00
	ST30S	T10	1 "	-	25	\$ 1,199.00
	ST40S	T12	1¼ "	-	15	\$ 1,852.00
	ST50S	T15	1½ "	-	10	\$ 2,486.00
	ST60S	T20	2 "	-	10	\$ 4,444.00
	ST70S	T25	2½ "	-	4	\$ 11,429.00
	ST80S	T30	3 "	-	4	\$ 11,429.00
	ST90S	T35	3½ "	-	4	\$ 19,808.00
	ST100S	T40	4 "	-	4	\$ 19,808.00
<b>TB-Fitting</b>						
	STB10S	TB05	½ "	-	30	\$ 3,193.00
	STB20S	TB07	¾ "	-	20	\$ 3,322.00
	STB30S	TB10	1 "	-	10	\$ 3,723.00
	STB40S	TB12	1¼ "	-	10	\$ 4,384.00
	STB50S	TB15	1½ "	-	15	\$ 5,315.00
	STB60S	TB20	2 "	-	10	\$ 5,976.00
<b>Service Entrance Cap</b>						
	EF10	MH05	½ "	-	25	\$ 816.00
	EF15	MH07	¾ "	-	25	\$ 773.00
	EF20	MH10	1 "	-	15	\$ 986.00
	EF25	MH12	1¼ "	-	20	\$ 1,517.00
	EF30	MH15	1½ "	-	5	\$ 2,571.00
	EF35	MH20	2 "	-	5	\$ 2,372.00
	EF40	MH25	2½ "	-	2	\$ 15,223.00
	EF45	MH30	3 "	-	2	\$ 14,829.00
	EF50	MH35	3½ "	-	2	\$ 21,659.00
	EF55	MH40	4 "	-	2	\$ 34,036.00
<b>Meter Offset</b>						
	MO25	MO12	1¼ "	-	40	\$ 718.00
	MO35	MO20	2 "	-	25	\$ 830.00
<b>Long Meter Offset</b>						
	LMO25	LMO12	1¼ "	-	25	\$ 2,202.00
	LMO30	LMO15	1½ "	-	25	\$ 2,215.00
	LMO35	LMO20	2 "	-	25	\$ 2,485.00
<b>Offset Meter Hub</b>						
	MHU25	MHU12	1¼ "	-	25	\$ 1,113.00
	MHU30	MHU15	1½ "	-	25	\$ 751.00
	MHU35	MHU20	2 "	-	25	\$ 695.00
	MHU40	MHU25	2½ "	-	8	\$ 4,029.00
	MHU45	MHU30	3 "	-	8	\$ 5,268.00
<b>Pipe Strap</b>						
	PS10	PS05	½ "	-	100	\$ 51.00
	PS15	PS07	¾ "	-	100	\$ 65.00
	PS20	PS10	1 "	-	100	\$ 75.00
	PS25	PS12	1¼ "	-	50	\$ 98.00
	PS30	PS15	1½ "	-	50	\$ 111.00
	PS35	PS20	2 "	-	25	\$ 148.00
	PS40	PS25	2½ "	-	100	\$ 235.00
	PS45	PS30	3 "	-	100	\$ 309.00
	PS55	PS40	4 "	-	50	\$ 640.00

	Catalogue Number	Alternate Number	Trade Size	Packaging Case	Box	List Price
<b>Steel Pipe Strap - PVC Coated - 2 hole</b>						
	CS35		2 "	-	50	\$ 536.00
	CS40		2½ "	-	50	\$ 546.00
	CS45		3 "	-	25	\$ 630.00
	CS50		3½ "	-	25	\$ 829.00
	CS55		4 "	-	15	\$ 1,475.00
	CS60		5 "	-	10	\$ 1,490.00
	CS65		6 "	-	5	\$ 3,380.00
<b>Steel Pipe Strap - PVC Coated - 1 hole</b>						
	CS10-1		½ "	-	50	\$ 324.00
	CS15-1		¾ "	-	50	\$ 340.00
	CS20-1		1 "	-	50	\$ 389.00
	CS25-1		1¼ "	-	50	\$ 492.00
	CS30-1		1½ "	-	50	\$ 592.00
	CS35-1		2 "	-	50	\$ 785.00
	CS40-1		2½ "	-	25	\$ 1,462.00
	CS45-1		3 "	-	25	\$ 1,462.00
	CS50-1		3½ "	-	20	\$ 1,535.00
	CS55-1		4 "	-	20	\$ 1,619.00
<b>Conduit Clamp &amp; Wall Spacer</b>						
	CCS10	CC10	½ "	-	150	\$ 173.00
	CCS15	CC15	¾ "	-	100	\$ 210.00
	CCS20	CC20	1 "	-	75	\$ 239.00
	CCS25	CC25	1¼ "	-	25	\$ 256.00
	CCS30	CC30	1½ "	-	25	\$ 313.00
	CCS35	CC35	2 "	-	25	\$ 266.00
	CCS40	CC40	2½ "	-	20	\$ 504.51
	CCS45	CC45	3 "	-	10	\$ 632.52
<b>PVC Reducer Bushing</b>						
	1805	MR0705	¾ x ½	-	100	\$ 137.00
	1805-1	MR1005	1 x ½	-	100	\$ 271.00
	1806	MR1007	1 x ¾	-	100	\$ 195.00
	1807-1	MR1207	1¼ x ¾	-	50	\$ 285.00
	1807	MR1210	1¼ x 1	-	100	\$ 349.00
	1808-1	MR1510	1½ x 1	-	50	\$ 376.00
	1808	MR1512	1½ x 1¼	-	50	\$ 392.00
	1809-1	MR2010	2 x 1	-	50	\$ 657.00
	1809	MR2012	2 x 1¼	-	25	\$ 735.00
	1810	MR2015	2 x 1½	-	25	\$ 897.00
	1811	MR2520	2½ x 2	-	15	\$ 1,568.00
	1812-1	MR3020	3 x 2	-	25	\$ 1,791.00
	1812	MR3025	3 x 2½	-	15	\$ 2,239.00
	1813-1	MR4020	4 x 2	-	15	\$ 3,620.00
1813	MR4030	4 x 3	-	10	\$ 4,040.00	
1814	MR4035	4 x 3½	-	15	\$ 4,117.00	
<b>Concentric PVC Reducers - Socket Weld - Custom sizes available - fax inquiries</b>						
	CR2012		2" x 1¼"	-	1	\$ 2,400.00
	CR3020		3" x 2"	-	1	\$ 3,375.00
	CR3025		3" x 2-1/2"	-	1	\$ 3,375.00
	CR4020		4" x 2"	-	1	\$ 3,903.00
	CR4025		4" x 2-1/2"	-	1	\$ 3,903.00
CR4030		4" x 3"	-	1	\$ 3,903.00	
<b>Threaded PVC Reducer - Spigot x Female Thread</b>						
	1825		¾" x ½"	-	50	\$ 832.00
	1826		1" x ½"	-	50	\$ 865.00
	1827		1" x ¾"	-	50	\$ 860.00

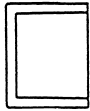
	Catalogue Number	Alternate Number	Trade Size	Packaging Case	Box	List Price
<b>Single Gang PVC Boxes</b>						
	FS10	FSE05-C	1/2"	-	10	\$ 1,371.00
	FS15	FSE07-C	3/4"	-	10	\$ 1,300.00
	FSS10	FSS05-C	1/2"	-	10	\$ 1,463.00
	FSS15	FSS07-C	3/4"	-	10	\$ 1,389.00
	FSC10	FSC05-C	1/2"	-	10	\$ 1,463.00
	FSC15	FSC07-C	3/4"	-	10	\$ 1,389.00
	FSCC10	FSCC05-C	1/2"	-	10	\$ 1,666.00
	FSCC15	FSCC07-C	3/4"	-	10	\$ 1,666.00
<b>Single Gang PVC Boxes - Deep</b>						
	FDS101520		1/2", 3/4", 1"	-	10	\$ 1,738.00
	FDC101520		1/2", 3/4", 1"	-	10	\$ 1,863.00
	FD-C	Blank	-	-	20	\$ 1,886.00
	FD347		-	-	10	\$ 2,515.00
<b>Double Gang PVC Boxes</b>						
	FS2-101520		1/2", 3/4", 1"	-	10	\$ 2,363.00
	FSS2-101520		1/2", 3/4", 1"	-	10	\$ 2,733.00
	FSC2-101520		1/2", 3/4", 1"	-	10	\$ 2,363.00
	FSCC2-101520		1/2", 3/4", 1"	-	10	\$ 2,999.00
	FD-2		-	-	10	\$ 2,935.00
<b>Triple Gang Boxes</b>						
	FS3-101520		1/2", 3/4", 1"	-	10	\$ 2,596.00
	FSC3-101520		1/2", 3/4", 1"	-	10	\$ 2,596.00
	FD-3		-	-	8	\$ 3,423.00
<b>Single Gang Cover Plates</b>						
	TSC15/10	Toggle Switch		-	100	\$ 577.00
	DRC15/10	Duplex Receptacle		-	100	\$ 577.00
	20RC15/10	15A Single Receptacle		-	100	\$ 577.00
	20-3RC15/10	20A Single Receptacle		-	100	\$ 577.00
	30-3RC15/10	30A Single Receptacle		-	100	\$ 577.00
	BRC15/10	Blank c/w Gasket		-	100	\$ 588.00
	GASK15/10	Gaskets for 'F' Boxes		-	1	\$ 92.00

	Catalogue Number	Alternate Number	Trade Size	Packaging Case	Box	List Price
<b>Single Gang Weatherproof Cover Plates</b>						
	VSC15/10			-	20	\$ 2,404.00
	VPT15/10			-	20	\$ 2,782.00
	WDR15/10			-	20	\$ 1,133.00
	RWDR15/10			-	20	\$ 1,133.00
	WGF15/10			-	20	\$ 1,133.00
	RWGF15/10			-	20	\$ 1,133.00
	WDRE15/10			-	30	\$ 620.00
	RWDRE15/10			-	30	\$ 620.00
	WDRE15/10			-	20	\$ 1,133.00
	WTL15		15 Amp - Single Receptacle Device Opening = 1.375"	-	20	\$ 1,690.00
	WTL20		20Amp - Single Receptacle Device Opening = 1.625"	-	20	\$ 1,690.00
	WTL30		30Amp Twist-Lock - Device Opening = 1.722"	-	20	\$ 2,672.00
	WTL50		50 Amp Twist Lock - Device Opening = 2.187"	-	20	\$ 5,815.00
	GASK W		Gask for W Ser. Except WDRE / RWDRE	-	1	\$ 313.00
	GASK DD		Gasket for WDRE / RWDRE covers	-	1	\$ 313.00
<b>Double Gang Cover Plates</b>						
	TSC20-2		Double Switch Cover	-	50	\$ 592.00
	TSDC20-2		Combination Switch - Receptacle Cover	-	50	\$ 592.00
	DRC20-2		Double Duplex Receptacle Cover	-	50	\$ 608.00
	BRC20-2		Blank/Cover/Gasket	-	50	\$ 829.00
<b>Double Gang Weatherproof Cover Plates</b>						
	VSC20-2		Toggle Switch Cover	-	10	\$ 3,792.00
	VSRC20-2		Comb. Switch Cover	-	10	\$ 4,570.00
	VSDR20-2		Comb. Switch Cover	-	10	\$ 4,791.00
	VSR20-2		Comb. Switch Cover	-	10	\$ 4,589.00
	VSGG20-2		Double Door Cover	-	15	\$ 1,445.00
	VSDD20-2		Double Door Duplex	-	15	\$ 1,445.00
	GASK20-2		Gaskets for 2-Gang	-	1	\$ 320.00
	GASKV20-2		Gaskets for VSGG20-2	-	1	\$ 320.00
<b>Triple Gang Cover Plates</b>						
	TSC20-3		Triple Switch Cover	-	50	\$ 1,126.00
	DSDR20-3		Double Switch / Single Receptacle	-	50	\$ 1,126.00
	TSDC20-3		Single Switch / Double Receptacle	-	50	\$ 1,126.00
	DRC20-3		Triple Receptacle	-	50	\$ 1,032.00
	BRC20-3		Triple Blank Cover	-	50	\$ 1,032.00
	GASK20-3		Gasket for 3-Gang	-	1	\$ 328.00
<b>Strain Relief Connectors</b>						
	SRC15		3/4" Strain Relief Connector - 3/4" solvent weld male end	-	50	\$ 804.00
<b>Threaded Strain Relief Connectors</b>						
	TSRC10		1/2" Threaded Strain Relief Connector	-	50	\$ 868.00
	TSRC15		3/4" Threaded Strain Relief Connector	-	50	\$ 1,122.00
<b>PVC Octagon Boxes and Knock out Plugs</b>						
	OB401507	OB15/10	3/4 "	-	15	\$ 1,488.00
	OB20		1 "	-	12	\$ 2,580.00
	KO07	KO15	3/4 "	-	1	\$ 92.00
	KO10	KO20	1 "	-	1	\$ 98.00
<b>Extension Ring</b>						
	XR20		1 "	-	20	\$ 986.00
	XR35		2 "	-	20	\$ 1,085.00

	Catalogue Number	Alternate Number	Trade Size	Packaging Case	Box	List Price	
<b>PVC End Cap</b>							
	CAP10	EC05	½ "	-	200	\$ 139.00	
	CAP15	EC07	¾ "	-	150	\$ 173.00	
	CAP20	EC10	1 "	-	100	\$ 236.00	
	CAP25	EC12	1¼ "	-	40	\$ 353.00	
	CAP30	EC15	1½ "	-	40	\$ 362.00	
	CAP35	EC20	2 "	-	20	\$ 446.00	
	CAP40	EC25	2½ "	-	15	\$ 982.00	
	CAP45	EC30	3 "	-	10	\$ 1,331.00	
	CAP55	EC40	4 "	-	12	\$ 2,937.00	
	CAP60	EC50	5 "	-	4	\$ 5,031.00	
	CAP65	EC60	6 "	-	10	\$ 6,986.00	
	<b>Junction Box Adapter</b>						
		JBA10	JBA05	½ "	-	100	\$ 273.00
JBA15		JBA07	¾ "	-	100	\$ 318.00	
JBA20		JBA10	1 "	-	100	\$ 736.00	
JBA25		JBA12	1¼ "	-	100	\$ 752.00	
JBA30		JBA15	1½ "	-	75	\$ 770.00	
JBA35		JBA20	2 "	-	40	\$ 776.00	
JBA40		JBA25	2½ "	-	20	\$ 923.00	
JBA45		JBA30	3 "	-	10	\$ 1,112.00	
JBA50		JBA35	3½ "	-	20	\$ 1,125.00	
JBA60		JBA40	4 "	-	15	\$ 1,128.00	
<b>O-Ring</b>							
	E943DX	E943DX	½ "	-	1	\$ 78.00	
	E943EX	E943EX	¾ "	-	1	\$ 78.00	
	E943FX	E943FX	1 "	-	1	\$ 100.00	
	E943GX	E943GX	1¼ "	-	1	\$ 125.00	
	E943HX	E943HX	1½ "	-	1	\$ 152.00	
	E943JX	E943JX	2 "	-	1	\$ 176.00	
	E943KX	E943KX	2½ "	-	1	\$ 243.00	
	E943LX	E943LX	3 "	-	1	\$ 388.00	
	E943NX	E943NX	4 "	-	1	\$ 329.00	
	<b>Highway Junction Box</b>						
	H664		6x6x4	-	4	\$ 29,600.00	
	H666		6x6x6	-	3	\$ 32,000.00	
	H884		8x8x4	-	3	\$ 49,700.00	
	H886		8x8x6	-	3	\$	
	H887		8x8x7	-	2	\$ 51,000.00	
	H887-A	Angled Base	8x8x7	-	2	\$ 52,200.00	
<b>PVC Junction Box</b>							
	JB442		4x4x2	-	15	\$ 1,238.00	
	JB444		4x4x4	-	10	\$ 2,477.00	
	JB446		4x4x6	-	8	\$ 4,042.00	
	JB552		5x5x2	-	12	\$ 2,890.00	
	JB664		6x6x4	-	15	\$ 4,024.00	
	JB666		6x6x6	-	4	\$ 6,653.00	
	JB884		8x8x4	-	4	\$ 6,871.00	
	JB887		8x8x7	-	4	\$ 10,290.00	
	JB12124		12x12x4	-	2	\$ 18,351.00	
	JB12126		12x12x6	-	4	\$ 19,948.00	
JB12128		12x12x8	-	3	\$ 32,975.00		

Catalogue Number	Alternate Number	Trade Size	Packaging Case	Box	List Price
<b>Custom PVC Junction Box</b>		<b>Dimensions - inches (L x W x H)</b>			<b>List Price per Each</b>
	JB10124	10 x 12 x 4	-	1	\$ 524.80
	JB121212	12 x 1 2x 12	-	1	\$ 550.47
	JB16166	16 x 16 x 6	-	1	\$ 570.43
	JB16168	16 x 16 x 8	-	1	\$ 588.83
	JB18186	18 x 18 x 6	-	1	\$ 644.04
	JB18188	18 x 18 x 8	-	1	\$ 662.44
	JB181810	18 x 18 x 10	-	1	\$ 772.84
	JB181812	18 x 18 x 12	-	1	\$ 809.65
	JB20208	20 x 20 x 8	-	1	\$ 846.45
	JB202012	20 x 20 x 12	-	1	\$ 883.25
	JB24244	24 x 24 x 4	-	1	\$ 883.25
	JB24246	24 x 24 x 6	-	1	\$ 920.05
	JB24248	24 x 24 x 8	-	1	\$ 920.05
	JB242410	24 x 24 x 10	-	1	\$ 956.85
	JB242412	24 x 24 x 12	-	1	\$ 1,012.06
	JB30188	30 x 18 x 8	-	1	\$ 1,104.06
	JB30308	30 x 30 x 8	-	1	\$ 1,140.86
	JB303010	30 x 30 x 10	-	1	\$ 1,177.67
	JB303012	30 x 30 x 12	-	1	\$ 1,214.47
	JB36248	36 x 24 x 8	-	1	\$ 1,288.07
	JB36368	36 x 36 x 8	-	1	\$ 1,398.48
	JB363610	36 x 36 x 10	-	1	\$ 1,472.08
	JB363612	36 x 36 x 12	-	1	\$ 1,582.49
	JB363614	36 x 36 x 14	-	1	\$ 1,766.50

**Note:**  
Custom PVC Boxes are Non-CSA, and Non-Returnable. Custom boxes are not suitable for direct burial.

**Expansion Joint**

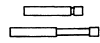

EJ10	EJ05	½ "	-	25	\$ 2,029.00
EJ15	EJ07	¾ "	-	25	\$ 1,973.00
EJ20	EJ10	1 "	-	40	\$ 2,139.00
EJ25	EJ12	1¼ "	-	20	\$ 2,580.00
EJ30	EJ15	1½ "	-	20	\$ 2,737.00
EJ35	EJ20	2 "	-	10	\$ 3,539.00
EJ40	EJ25	2½ "	-	9	\$ 6,939.00
EJ45	EJ30	3 "	-	9	\$ 5,246.00
EJ50	EJ35	3½ "	-	5	\$ 19,835.00
EJ55	EJ40	4 "	-	5	\$ 23,451.00
EJ60	EJ50	5 "	-	1	\$ 38,192.00
EJ65	EJ60	6 "	-	1	\$ 49,012.00

**Expansion & Deflection Assembly**



SE-J-35	ED-20	2 "	-	1	\$ 336.00
SE-J-45	ED-30	3 "	-	1	\$ 562.00
SE-J-55	ED-40	4 "	-	1	\$ 677.00

**Rigid PVC End Bell**

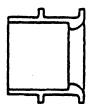

EB10	EB05	½ "	-	200	\$ 1,291.00
EB15	EB07	¾ "	-	200	\$ 1,291.00
EB20	EB10	1 "	-	100	\$ 1,291.00
EB25	EB12	1¼ "	-	100	\$ 1,291.00
EB30	EB15	1½ "	-	50	\$ 1,291.00
EB35	EB20	2 "	-	80	\$ 1,291.00
EB40	EB25	2½ "	-	20	\$ 2,055.00
EB45	EB30	3 "	-	30	\$ 3,224.00
EB50	EB35	3½ "	-	50	\$ 4,135.00
EB55	EB40	4 "	-	40	\$ 4,544.00
EB60	EB50	5 "	-	25	\$ 12,060.00
EB65	EB60	6 "	-	15	\$ 12,060.00

**Heat Gun**



HG751	Heat Gun - 110 Volt, 20		-	1	\$ 1,388.00
HAS-015K	Replacement Element		-	1	\$ 189.00

Catalogue Number	Alternate Number	Trade Size	Packaging Case	Box	List Price
<b>PVC Cement and Primer</b>					
	CEM125	-	125mL	-	24 \$ 6.67
	CEM250	S100PT5	250mL	-	24 \$ 7.78
	CEM500	S100PT	475mL	-	12 \$ 13.33
	CEM1	S100QT	950mL	-	12 \$ 18.89
	CEM4	S100GAL	4L	-	4 \$ 71.11
	PRIM250	S100TPT5	250mL	-	24 \$ 7.78
	PRIM500	S100TPT	475mL	-	12 \$ 13.33

## DBII Conduit and Fittings

DBII Conduit	CRATE	Trade Size	Length	Weight	Price
08220	2 "	I-2460'	R-2460'	-	\$ 364.00
08230	3 "	I-1120'	R-1120'	-	\$ 545.00
08235	3½ "	I-810'	-	-	\$ 723.00
08240	4 "	I-630'	R-630	-	\$ 783.00
08250	5 "	I-430'	R-380'	-	\$ 1,271.00
08260	6 "	I-280'	R-260'	-	\$ 1,771.00

Split Duct: add 30% to cost of DBII Conduit

### PVC Coupling - Solvent Weld

	SWC020	2 "	-	100	\$ 492.00
	SWC030	3 "	-	50	\$ 563.00
	SWC040	4 "	-	40	\$ 785.00
	SWC050	5 "	-	15	\$ 2,133.00
	SWC060	6 "	-	9	\$ 2,824.00

### Polyethylene Coupling - Push Fit

	PFC020	2 "	-	200	\$ 248.00
	PFC030	3 "	-	100	\$ 285.00
	PFC040	4 "	-	90	\$ 338.00
	PFC050	5 "	-	50	\$ 733.00
	PFC060	6 "	-	35	\$ 995.00

### PVC 5° Coupling - Solvent Weld

	5ACS20	2 "	-	75	\$ 1,885.00
	5ACS30	3 "	-	45	\$ 2,125.00
	5ACS40	4 "	-	25	\$ 1,836.00
	5ACS50	5 "	-	15	\$ 6,080.00
	5ACS60	6 "	-	20	\$ 6,692.00

### Polyethylene 5° - Push Fit









	5APF30	3 "	-	100	\$ 995.00
	5APF40	4 "	-	90	\$ 1,190.00
	5APF50	5 "	-	45	\$ 5,535.00

### Expansion Joint





EXPJ20	2 "	-	10	\$ 22,537.00
EXPJ30	3 "	-	10	\$ 26,573.00
EXPJ40	4 "	-	8	\$ 36,925.00

### Reducer Coupling - Solvent Weld

	RC3020	3 x 2	-	30	\$ 2,824.00
	RC3520	3½ x 3	-	35	\$ 2,908.00
	RC3530	3½ x 3	-	30	\$ 2,986.00
	RC4020	4 x 2	-	35	\$ 1,415.00
	RC4030	4 x 3	-	30	\$ 2,352.00
	RC4035	4 x 3½	-	40	\$ 3,258.00
	RC5040	5 x 4	-	25	\$ 5,640.00
	RC6040	6 x 4	-	20	\$ 5,793.00

Catalogue Number	Alternate Number	Trade Size	Packaging Case	Box	List Price
<b>Split Wye - Solvent Weld</b>					
	SPLY20	2"	-	20	\$ P.O.R.
	SPLY30	3"	-	20	\$ P.O.R.
	SPLY40	4"	-	18	\$ P.O.R.
<b>PVC Female Adapter-I.P.S.</b>					
	FEMA20	2"	-	100	\$ 3,170.00
	FEMA30	3"	-	30	\$ 4,512.00
	FEMA40	4"	-	15	\$ 3,822.00
	FEMA50	5"	-	15	\$ 18,577.00
	FEMA60	6"	-	6	\$ 21,443.00
<b>Conduit to Duct Adapter - Rigid I.P.S. Conduit - Socket x Duct Socket</b>					
	ARIG20	2"	-	24	\$ 1,488.00
	ARIG30	3"	-	30	\$ 1,488.00
	ARIG40	4"	-	15	\$ 1,497.00
	ARIG50	5"	-	20	\$ 2,439.00
	ARIG60	6"	-	15	\$ 4,315.00
<b>Terminator with Knock-out Plug</b>					
	TERM40H	with holes	4"	60	\$ 1,657.00
	TERM40W	without holes	4"	60	\$ 1,657.00
<b>Reducing Adapter Coupling - Duct Socket x PVC Conduit Socket</b>					
	ARIG3020	3" x 2"	-	18	\$ 6,372.00
	ARIG4020	4" x 2"	-	40	\$ 7,106.00
	ARIG4030	4" x 3"	-	15	\$ 7,106.00
	ARIG5040	5" x 4"	-	1	\$ 6,393.00
	ARIG6040	6" x 4"	-	1	\$ 7,393.00
<b>Big 'O' Conduit</b>					
	B40	4"		250'	\$ 1,170.00
<b>DBII Bell End</b>					
	BELL20	2"	-	75	\$ 1,138.00
	BELL30	3"	-	75	\$ 1,332.00
	BELL40	4"	-	25	\$ 1,585.00
	BELL50	5"	-	20	\$ 4,473.00
	BELL60	6"	-	15	\$ 4,702.00
<b>Cap - Solvent Weld</b>					
	SWCA20	2"	-	75	\$ 948.00
	SWCA30	3"	-	20	\$ 948.00
	SWCA40	4"	-	50	\$ 948.00
	SWCA50	5"	-	25	\$ 4,673.00
	SWCA60	6"	-	15	\$ 5,169.00
<b>Tapered Plug</b>					
	PLUG20	2"	-	100	\$ 895.00
	PLUG30	3"	-	100	\$ 1,415.00
	PLUG40	4"	-	100	\$ 1,266.00
	PLUG50	5"	-	50	\$ 1,389.00
	PLUG60	6"	-	35	\$ 3,382.00



						Net Price
Catalogue	Alternate		Packaging			List
Number	Number	Trade Size	Case	Box		Price
<b>Universal Pipe Plug</b>						
	UPP35	2 "	-	70	\$	895.00
	UPP45	3 "	-	80	\$	1,415.00
	UPP55	4 "	-	50	\$	1,266.00
	UPP60	5 "	-	60	\$	1,389.00
	UPP65	6 "	-	30	\$	3,382.00
<b>90° Long Sweep Bend</b>						
	902024	2 " 24" R	-	1	\$	4,530.00
	902036	2 " 36" R	-	1	\$	5,399.00
	902060	2 " 60" R	-	1	\$	9,997.00
	903024	3 " 24" R	-	1	\$	10,795.00
	903036	3 " 36" R	-	1	\$	9,358.00
	903060	3 " 60" R	-	1	\$	15,535.00
	904024	4 " 24" R	-	1	\$	8,848.00
	904036	4 " 36" R	-	1	\$	10,211.00
	904060	4 " 60" R	-	1	\$	16,420.00
	905042	5 " 42" R	-	1	\$	20,172.00
	905060	5 " 60" R	-	1	\$	25,773.00
	906060	6 " 60" R	-	1	\$	32,835.00
<b>45° Long Sweep Bend</b>						
	452024	2 " 24" R	-	1	\$	3,477.00
	452036	2 " 36" R	-	1	\$	4,084.00
	453024	3 " 24" R	-	1	\$	6,040.00
	453036	3 " 36" R	-	1	\$	5,817.00
	454024	4 " 24" R	-	1	\$	7,215.00
	454036	4 " 36" R	-	1	\$	7,252.00
	454060	4 " 60" R	-	1	\$	9,395.00
	455042	5 " 42" R	-	1	\$	25,773.00
	456060	6 " 60" R	-	1	\$	32,835.00
<b>22-1/2° Long Sweep Bend</b>						
	223036	3 " 36" R	-	1	\$	6,897.00
	224036	4 " 36" R	-	1	\$	7,256.00
	225042	5 " 42" R	-	1	\$	12,779.00
<b>Intermediate Vertical Spacer</b>						
	29550	IS3530	2 x 1½	-	350	\$ 650.00
	29551	IS3535	2 x 2	-	300	\$ 792.00
	29552	IS3545	2 x 3	-	200	\$ 771.00
	29553	IS4530	3 x 1½	-	225	\$ 722.00
	29554	IS4535	3 x 2	-	200	\$ 831.00
	29555	IS4545	3 x 3	-	125	\$ 898.00
	29556	IS5520	4 x 1	-	200	\$ 764.00
	29340	IS5530	4 x 1½	-	125	\$ 843.00
	29341	IS5535	4 x 2	-	110	\$ 916.00
	29559	IS5545	4 x 3	-	90	\$ 1,056.00
	29350	IS6030	5 x 1½	-	100	\$ 916.00
	29561	IS6035	5 x 2	-	100	\$ 1,072.00
	29562	IS6045	5 x 3	-	80	\$ 1,180.00
	29563	IS6530	6 x 1½	-	100	\$ 1,086.00
	29564	IS6535	6 x 2	-	90	\$ 1,463.00
	29565	IS6545	6 x 3	-	70	\$ 1,695.00

Catalogue Number	Alternate Number	Trade Size	Packaging		List Price
			Case	Box	
<b>Base Vertical Spacer</b>					
29566	BS3530	2 x 1½	-	250	\$ 730.00
29567	BS3535	2 x 2	-	225	\$ 860.00
29568	BS3545	2 x 3	-	225	\$ 823.00
29569	BS4530	3 x 1½	-	175	\$ 839.00
29570	BS4535	3 x 2	-	155	\$ 898.00
29571	BS4545	3 x 3	-	150	\$ 898.00
29572	BS5520	4 x 1	-	175	\$ 796.00
29440	BS5530	4 x 1½	-	100	\$ 932.00
29441	BS5535	4 x 2	-	100	\$ 988.00
29575	BS5545	4 x 3	-	120	\$ 1,116.00
29450	BS6030	5 x 1½	-	100	\$ 1,031.00
29577	BS6035	5 x 2	-	120	\$ 1,089.00
29578	BS6045	5 x 3	-	100	\$ 1,190.00
29579	BS6530	6 x 1½	-	100	\$ 1,199.00
29580	BS6535	6 x 2	-	100	\$ 1,665.00
29581	BS6545	6 x 3	-	95	\$ 1,780.00

**Mono-Bloc Spacers**

29473	2x1-½x1-½x3		2 way	25	\$	227.00
29474	3x1-½x1-½x3		2 way	25	\$	260.00
29860	3-½x1x1x2		2 way	25	\$	143.00
29861	3-½x1x1x2		3 way	25	\$	377.00
29479	3½x1x1x2		4 way	25	\$	439.00
29475	4x1x1x2		1 way	25	\$	123.00
29476	4x1x1x2		2 way	25	\$	162.00
29477	4x1x1x2		3 way	25	\$	233.00
29478	4x1x1x2		4 way	25	\$	263.00
29470	4x1-½x1-½x3		2 way	25	\$	222.00
29471	4x1-½x1-½x3		3 way	25	\$	308.00
29472	4x1-½x1-½x3		4 way	25	\$	367.00
29480	4x2x2x3		1 way	25	\$	186.00
29464	4x2x2x3		2 way	25	\$	283.00
29465	4x2x2x3		3 way	25	\$	344.00
29499	4x2x2x3		4 way	25	\$	389.00
29466	4x3x3x3	BASE	2 way	25	\$	332.00
29488	4x3x3x3	BASE	3 way	25	\$	446.00
29489	4x3x3x3	BASE	4 way	25	\$	490.00
29469	4x3x3x4		2 way	25	\$	332.00
29497	4x3x3x4		3 way	25	\$	446.00
29498	4x3x3x4		4 way	25	\$	490.00
29485	4-½x2x2x3		1 way	25	\$	206.00
29486	4-½x2x2x3		2 way	25	\$	294.00
29487	4-½x2x2x3		3 way	25	\$	355.00
29455	5x1½x2-1/8x3-5/8		1 way	50	\$	249.00
29494	5x1-½x1-½x3		2 way	25	\$	316.00
29495	5x1-½x1-½x3		3 way	25	\$	385.00
29496	5x1-½x1-½x3		4 way	25	\$	452.00

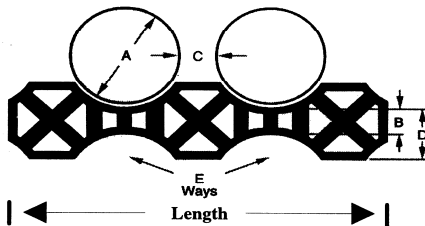

Nominal Pipe Size	Vertical Spacing	Horizontal Spacing	Ground Clearance	Number of Ways
(A)	(B)	(C)	(D)	(E)
2-3	1½	1½	3	2
3½	1	1	2	2-3
4	1	1	2	1-2-3-4
4	1½	1½	3	2-3-4
4	2	2	3	1-2-3-4
4	3	3	3	2
4	3	3	4	2
4½	2	2	3	1-2-3
5	1½	1½	3	1-2-3-4

Catalogue Number	Alternate Number	Trade Size	Packaging Case	Box	List Price
------------------	------------------	------------	----------------	-----	------------

## ENT Conduit and Fittings

### ENT Conduit



05ENTC	coils	½ "	-	370	\$	140.00
07ENTC	coils	¾ "	-	240	\$	198.00
10ENTC	coils	1" "	-	160	\$	288.00
12ENTC	coils	1¼ "	-	500	\$	329.00
15ENTC	coils	1½ "	-	300	\$	459.00
20ENTC	coils	2" "	-	225	\$	536.00



05ENTR	reels	½ "	I-1500'	R-2000'	\$	162.00
07ENTR	reels	¾ "	I-1000'	R-1500'	\$	230.00
10ENTR	reels	1" "	I-750'	R-1000'	\$	325.00
12ENTR	reels	1¼ "	I-1000'	R-1000'	\$	380.00
15ENTR	reels	1½ "	-	R-750'	\$	511.00
20ENTR	reels	2" "	I-500'	R-500'	\$	593.00

### ENT Coupling



KC10		½ "	-	150	\$	236.00
KC15		¾ "	-	100	\$	384.00
KC20		1" "	-	50	\$	618.00
KC25		1¼ "	-	30	\$	686.00
KC30		1½ "	-	30	\$	760.00
KC35		2" "	-	20	\$	842.00

### ENT Snap in Connector



KTS10		½ "	-	150	\$	171.00
KTS15		¾ "	-	100	\$	290.00
KTS20		1" "	-	50	\$	508.00

### ENT-EMT Coupling



KTC10		½ "	-	150	\$	246.00
KTC15		¾ "	-	100	\$	404.00
KTC20		1" "	-	50	\$	650.00

### ENT Connector



KTA10		½ "	-	150	\$	171.00
KTA15		¾ "	-	100	\$	290.00
KTA20		1" "	-	50	\$	508.00
KTA25		1¼ "	-	30	\$	686.00
KTA30		1½ "	-	30	\$	760.00
KTA35		2" "	-	20	\$	842.00

### Floor Box



ECM10		½ "	-	150	\$	165.00
ECM15		¾ "	-	150	\$	165.00
ECM20		1" "	-	150	\$	197.00
ECM25		1¼ "	-	150	\$	340.00



### Tapered Plug







TP10		½ "	-	100	\$	59.00
TP15		¾ "	-	100	\$	62.00
TP20		1" "	-	100	\$	91.00

Catalogue Number	Alternate Number	Trade Size	Packaging Case	Box	List Price
------------------	------------------	------------	----------------	-----	------------

**Slab Boxes without Molded Connectors**

	SMB-10	Knockout Configuration:	8x½"	25	\$ 1,898.00
	SMB-10/20	Knockout Configuration:	4x½", 2x¾"	25	\$ 1,898.00

**Slab Boxes with Molded Connectors**

	SMB-H-10	Knockout Configuration:	8 x ½"	25	\$ 2,710.00
	SMB-H-10/20	Knockout Configuration:	4x½", 2x¾"	25	\$ 2,710.00
	SMB-H-10/15	Knockout Configuration:	4x½", 4x¾"	25	\$ 2,710.00
	SMB-H-15	Knockout Configuration:	8 x ¾"	25	\$ 2,710.00
	SMB-H-15/20	Knockout Configuration:	4x¾", 4x½"	25	\$ 2,710.00

**Square Slab Boxes with Molded Connectors**

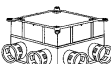
	SSBH-10	Knockout Configuration:	8 x ½"	25	\$ 3,456.00
	SSBH-15		8 x ¾"	25	\$ 3,456.00
	SSBH-10/15		4x½", 4x¾"	25	\$ 3,456.00

**ENT Box Cover - 4" Square**

	KWBC-10	1/2"	50	\$ 445.00
---	---------	------	----	-----------

**45° Angled ENT Form Stubby**

	KASTB10	1/2"	50	\$ 272.00
	KASTB15	3/4"	50	\$ 272.00
	KASTB20	1"	50	\$ 324.00
	KASTB25	1-1/4"	50	\$ 563.00
	KASTB30	1-1/2"	50	\$ 618.00

**Nonmetallic Incandescent Fixtures**

**Ceiling Mount**

					<u>List / EA</u>
	LVPF150C			6	\$ 70.00

	Catalogue Number	Alternate Number	Trade Size	Packaging Case	Box	List Price
<b>Pendant Mount</b>						<u>List / EA</u>
	LPMF150C	Non-metallic Pendant Mount Incandescent Light Fixture			6	\$ 79.00
<b>Wall Mount</b>						
	LWMF150C	Non-metallic Wall Mount Incandescent Light Fixture			6	\$ 94.00
<b>Nonmetallic Replacement Guard</b>						
	LVPUG150	Replacement Guard for Light fixture			30	\$ 9.00
<b>Nonmetallic Utility Light Fixture</b>						
	LVPE150-10/15	Non-metallic Vapour-proof Incandescent Light Fixture			6	\$ 31.00
<b>Heat Resistant Globes</b>						<u>List / EA</u>
	LG150T	Clear Glass Globe				\$ 24.00
<b>Components</b>						
	LVPB 150	Ceiling Mount Box				\$ 30.00
	LPC 150	Pendant Mount Cap				\$ 38.00
	LWB 150	90 Wall Bracket				\$ 32.00
	LVPG 150	Guard				\$ 9.00

Catalogue Number	Alternate Number	Trade Size	Packaging Case	Box	List Price
------------------	------------------	------------	----------------	-----	------------

**Red Series - CSA Series 75 psi**

					per 100'
Black Poly Pipe	15200	1/2"		100'	\$ 37.75
	15203	3/4"		100'	\$ 56.41
	15206	1"		100'	\$ 87.01
	15209	1-1/4"		100'	\$ 151.07
	15213	1-1/2"		100'	\$ 204.11
	15217	2"		100'	\$ 337.64
					per 100'
Black Poly Pipe	15201	1/2"		400'	\$ 37.75
	15204	3/4"		400'	\$ 56.41
	15207	1"		300'	\$ 87.01
	15210	1-1/4"		300'	\$ 151.07
	15214	1-1/2"		250'	\$ 204.11
	15218	2"		500'	\$ 337.64

**White Series - Utility Series 75 psi**

					per 100'
Black Poly Pipe	18200	1/2"		100'	\$ 27.37
	18203	3/4"		100'	\$ 36.63
	18206	1"		100'	\$ 57.75
	18209	1-1/4"		100'	\$ 85.81
	18213	1-1/2"		100'	\$ 112.97
	18217	2"		100'	\$ 168.26
					per 100'
Black Poly Pipe	18201	1/2"		400'	\$ 27.37
	18204	3/4"		400'	\$ 36.63
	18207	1"		300'	\$ 57.75
	18210	1-1/4"		300'	\$ 85.81
	18215	1-1/2"		250'	\$ 112.97
	18218	2"		500'	\$ 167.70

**SDR Series - Poly Pipe with Pull String**

					per 100'
SDR-05	SDR11-HDPE	1/2"		1500	\$ 47.15
SDR-07	Grey with pull rope	3/4"		1200	\$ 55.01
SDR-10		1"		500	\$ 62.87
SDR-12	SDR13.5 HDPE	1-1/4"		500	\$ 74.66
SDR-15	Black	1-1/2"		500	\$ 80.55
SDR-20		2"		500	\$ 102.16
SDR-30		3"		100	\$ 206.29
SDR-40		4"		100	\$ 402.76



## INDEX

ALPHA NUMERIC LISTING BY CATALOGUE NUMBER

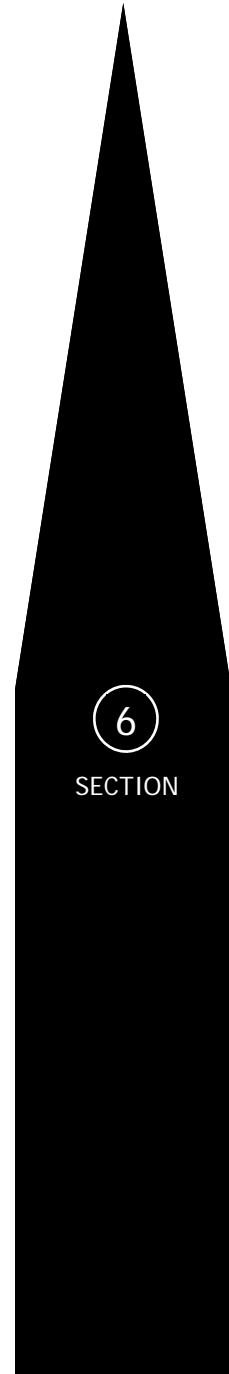

August 1, 2010

**NE12-LIST**

Effective Date: August 1, 2010



Catalogue #	Pg.#	Catalogue #	Pg.#	Catalogue #	Pg.#	Catalogue #	Pg.#	Catalogue #	Pg.#	Catalogue #	Pg.#
100	50	261	28	471	42	536	32	719	24	1200	55
101	50	262	28	472	42	541	32	720	24	1201	55
102	50	263	28	473	42	542	32	731	36	1202	55
103	50	264	28	474	42	543	32	732	36	1209	55
104	50	265	28	475	42	544	32	733	36	1210	55
105	50	266	28	476	42	545	32	734	36	1591	54
106	50	271	23	477	42	546	32	735	36	1592	54
107	50	272	23	478	42	561	33	736	36	1593	54
108	50	273	23	479	42	562	33	737	36	1594	54
109	50	291	34	480	42	563	33	738	36	1595	54
110	50	292	34	481	33	564	33	739	36	1596	54
111	32	293	34	482	33	565	33	740	36	1597	54
112	32	294	34	483	33	566	33	741	36	1598	54
113	32	295	34	484	33	567	33	742	36	1661	59
114	32	296	34	485	33	568	33	743	36	1662	59
115	32	311	25	486	33	569	33	744	36	1663	59
116	32	312	25	487	33	570	33	745	36	1664	59
117	32	313	25	488	33	571	68	746	36	1665	59
118	32	314	25	489	33	572	68	747	36	1666	59
120	53	315	25	490	42	573	68	748	36	1667	59
122	58	316	25	491	42	574	68	749	36	1668	59
123	58	317	25	492	42	576	68	750	36	1669	59
124	58	318	25	493	42	577	68	751	32	1670	59
150	50	319	25	494	42	579	68	752	32	1805	98
151	50	320	25	495	42	581	68	753	32	1806	98
152	50	321	25	496	42	581	71	754	32	1807	98
153	50	322	25	497	42	582	68	755	32	1808	98
154	50	323	25	498	42	582	71	756	32	1809	98
155	50	324	25	499	42	583	68	757	32	1810	98
156	50	325	25	500	42	583	71	758	32	1811	98
157	50	326	25	511	21	584	68	759	32	1812	98
158	50	327	25	512	21	584	68	760	32	1813	98
159	50	328	25	513	21	584	71	781	23	1814	98
160	50	329	25	514	21	584	71	782	23	1825	98
175	61	330	25	515	21	586	68	851	28	1826	98
180	53	350	52	516	21	586	71	852	28	1827	98
181	53	351	33	517	21	587	68	853	28	3510	27
182	53	352	33	517	32	587	68	854	28	3511	27
187	55	353	33	518	21	587	71	855	28	3610	27
188	55	354	33	518	32	587	71	856	28	3611	27
189	55	360	53	519	21	589	68	857	28	8618	46
191	25	361	33	519	32	589	68	858	28	8620	46
192	25	362	33	520	21	589	71	859	28	9882	59
193	25	363	33	520	32	589	71	860	28	11109	63
194	25	364	33	521	22	601	58	868	55	11421	64
195	25	373	22	522	22	602	58	870	55	11424	64
196	25	411	60	523	22	603	58	952	53	11426	64
201	33	412	60	524	22	604	58	953	53	11432	64
202	33	413	60	525	22	605	58	954	53	11433	64
203	33	450	53	526	22	606	58	955	53	15004	45
204	33	451	53	527	22	607	58	956	53	15005	45
205	33	452	53	527	32	608	58	961	55	15007	45
206	33	453	53	528	22	609	58	962	56	15008	45
207	33	454	53	528	32	610	58	965	55	15009	45
208	33	455	53	529	22	630	60	981	34	15010	45
209	33	456	53	529	32	711	24	982	34	15011	45
210	33	461	53	530	22	712	24	983	34	15104	45
251	28	462	53	530	32	713	24	984	36	15105	45
252	28	463	53	531	32	714	24	985	36	15107	45
253	28	464	53	532	32	715	24	986	36	15108	45
254	28	465	53	533	32	716	24	987	36	15109	45
255	28	466	53	534	32	717	24	1112	32	15110	45
256	28	470	42	535	32	718	24	1113	32	15111	45



**NE12-LIST**

Effective Date: August 1, 2010



Catalogue #	Pg.#	Catalogue #	Pg.#	Catalogue #	Pg.#	Catalogue #	Page #	Catalogue #	Pg.#	Catalogue #	Pg.#
15200	110	29556	105	07CBLT150	41	1127-RT	29	155i	50	225ELBT20	14
15201	110	29559	105	07CBLT30	41	1128-RT	29	155M	51	225ELBT25	14
15203	110	29561	105	07EFLT150	42	1129-RT	29	155Mi	51	225ELBT30	14
15204	110	29562	105	07EFLT30	42	1130-RT	29	156i	50	225ELBT35	14
15206	110	29563	105	07ENTC	107	1161-HZ	75	156M	51	225ELBT40	14
15207	110	29564	105	07ENTR	107	1162-HZ	75	156Mi	51	230-DC2	15
15209	110	29565	105	07LT150	41	1163-HZ	75	157i	50	230-DCI2	15
15210	110	29566	106	07LT30	41	1164-HZ	75	157M	51	230S	43
15213	110	29567	106	07LT300	41	1165-HZ	75	157Mi	51	230-SBLU	19
15214	110	29568	106	07ULLT30	41	1166-HZ	75	158i	50	230-SR	20
15217	110	29569	106	08220	103	1167-HZ	75	158M	51	231-DC2	15
15218	110	29570	106	08230	103	1168-HZ	75	158Mi	51	231-DCI2	15
18200	110	29571	106	08235	103	1169-HZ	75	159i	50	231S	43
18201	110	29572	106	08240	103	1170-HZ	75	159M	51	231-SBLK	19
18203	110	29575	106	08250	103	1171-HZ	75	159Mi	51	231-SBLU	19
18204	110	29577	106	08260	103	1172-HZ	75	15ALF15	49	231-SG	19
18206	110	29578	106	101i	50	1173-HZ	75	15ALF75	49	231-SO	19
18207	110	29579	106	101M	51	1174-HZ	75	15EFLT15	42	231-SR	20
18209	110	29580	106	101Mi	51	1175-HZ	75	15ENTC	107	231-SW	20
18210	110	29581	106	102i	50	11C1	61	15ENTR	107	231-SY	20
18213	110	29860	106	102M	51	11C10	61	15LT15	41	232-DC2	15
18215	110	29861	106	102Mi	51	11C2	61	15LT75	41	232-DCI2	15
18217	110	223036	105	103i	50	11C3	61	15ULLT15	41	232S	43
18218	110	224036	105	103M	51	11C4	61	160i	50	232-SBLU	19
29340	105	225042	105	103Mi	51	11C5	61	160M	51	232-SR	20
29341	105	452024	105	104i	50	121-S	24	160Mi	51	233-DC2	15
29350	105	452036	105	104M	51	122S	58	1620-DC2	23	233-DCI2	15
29440	106	453024	105	104Mi	51	122-S	24	1621-DC2	23	233S	43
29441	106	453036	105	105i	50	123S	58	1622-DC2	23	233-SBLU	19
29450	106	454024	105	105M	51	123-S	24	1701-DC	15	233-SR	20
29455	106	454036	105	105Mi	51	124-S	24	1702-DC	15	234-DC2	15
29464	106	454060	105	106i	50	125-S	24	1805-1	98	234-DCI2	15
29465	106	455042	105	106M	51	126-S	24	1807-1	98	234S	43
29466	106	456060	105	106Mi	51	127-S	24	1808-1	98	234-SR	20
29469	106	902024	105	107i	50	128-S	24	1809-1	98	235-DC2	15
29470	106	902036	105	107M	51	129-S	24	1812-1	98	235-DCI2	15
29471	106	902060	105	107Mi	51	12ALF15	49	1813-1	98	235S	43
29472	106	903024	105	108i	50	12ALF75	49	182A	53	235-SR	20
29473	106	903036	105	108M	51	12EFLT15	42	189-100	55	236-DC2	15
29474	106	903060	105	108Mi	51	12ENTC	107	189B	55	236-DCI2	15
29475	106	904024	105	109i	50	12ENTR	107	20-3RC15/10	99	236S	43
29476	106	904036	105	109M	51	12LT15	41	20ALF15	49	236-SR	20
29477	106	904060	105	109Mi	51	12LT75	41	20ALF75	49	237-DC2	15
29478	106	905042	105	10ALF150	49	12ULLT15	41	20EFLT15	42	237-DCI2	15
29479	106	905060	105	10ALF30	49	130-S	24	20ENTC	107	237S	43
29480	106	906060	105	10ALF300	49	131-S	24	20ENTR	107	237-SR	20
29485	106	05ALF150	49	10CBLT150	41	132-S	24	20LT15	41	238-DC2	15
29486	106	05ALF30	49	10CBLT30	41	143R	53	20LT30	41	238-DCI2	15
29487	106	05ALF300	49	10EFLT30	42	144R	53	20RC15/10	99	238S	43
29488	106	05CBLT30	41	10ENTC	107	145R	53	20ULLT15	41	239-DC2	15
29489	106	05CBLT300	41	10ENTR	107	146R	53	2100-S	58	239-DCI2	15
29494	106	05CLBT150	41	10LT150	41	151i	50	2110-S	58	240-DC	15
29495	106	05EFLT30	42	10LT30	41	151M	51	2120-S	58	240S	43
29496	106	05EFLT300	42	10ULLT30	41	151Mi	51	2125-S	58	240-SBLU	20
29497	106	05ENTC	107	110i	50	152i	50	2130-S	58	240-SR	20
29498	106	05ENTR	107	110M	51	152M	51	2140-S	58	241-BLK	20
29499	106	05LT150	41	110Mi	51	152Mi	51	2150-S	58	241-DC	15
29550	105	05LT30	41	1121-RT	29	153i	50	2160-S	58	241-SBLU	20
29551	105	05LT300	41	1122-RT	29	153M	51	2170-S	58	241-SG	20
29552	105	05ULLT30	41	1123-RT	29	153Mi	51	2180-S	58	241-SO	20
29553	105	07ALF150	49	1124-RT	29	154i	50	2190-S	58	241-SR	20
29554	105	07ALF30	49	1125-RT	29	154M	51	225ELBT12	14	241-SW	21
29555	105	07ALF300	49	1126-RT	29	154Mi	51	225ELBT15	14	241-SY	21

**NE12-LIST**

Effective Date: August 1, 2010



Catalogue #	Pg.#	Catalogue #	Pg.#	Catalogue #	Pg.#	Catalogue #	Pg.#	Catalogue #	Pg.#	Catalogue #	Pg.#
242-DC	15	3838ASP	52	437-6-120	88	4ELBA25	38	533AL	39	653SRT	18
242-SBLU	20	3838SP	52	437-6-24	88	4ELBA30	38	534AL	39	654SIRT	18
242-SR	20	38ALF150	49	437-6-6	88	4ELBA35	38	535AL	39	654SRT	18
243-DC	15	38ALF300	49	437-6R-12	88	4ELBA40	38	536AL	39	655SIRT	18
243-SBLU	20	38ALF75	49	437-6R-120	88	4ELBR05	26	545-DC2	50	655SRT	18
243-SR	20	38ASP	52	437-6R-24	88	4ELBR07	26	54C1	62	656SIRT	18
244-DC	15	38CBLT150	41	437-6R-6	88	4ELBR10	26	54C3	63	656SRT	18
244-SR	20	38CBLT30	41	437-8-12	88	4ELBR12	26	54C3-1/2	63	657SIRT	18
245-DC	15	38CBLT300	41	437-8-120	88	4ELBR15	26	54C6	62	657SRT	18
245-SR	20	38EFLT30	42	437-8-24	88	4ELBR20	26	54C64	63	658SIRT	18
246-DC	15	38LT150	41	437-8-6	88	4ELBR25	26	54C65	63	658SRT	18
246-SR	20	38LT30	41	437-8R-12	88	4ELBR30	26	54C94	63	659SIRT	18
247-DC	15	38LT300	41	437-8R-120	88	4ELBR35	26	561A	53	659SRT	18
247-SR	20	38ULLT30	41	437-8R-24	88	4ELBR40	26	571S	71	660SIRT	18
248-DC	15	391S	22	437-8R-6	88	4ELBR50	26	572S	71	660SRT	18
249-DC	15	391S	33	469-SLT	43	4ELBR60	26	573S	71	661SRT	18
250-DC2	16	392S	22	470i	42	4ELBT05	14	574S	71	662SRT	18
250-DCI2	16	392S	33	470S	43	4ELBT07	14	574S	71	663SRT	18
251-DC2	16	393S	22	470-SLT	43	4ELBT10	14	576S	71	664SRT	18
251-DCI2	16	393S	33	471i	42	4ELBT12	14	577S	71	665SRT	18
252-DC2	16	3ELBR20	26	471S	43	4ELBT15	14	577S	71	666SRT	18
252-DCI2	16	3ELBR25	26	471-SLT	43	4ELBT20	14	579S	71	667SRT	18
253-DC2	16	3ELBR30	26	472i	42	4ELBT25	14	579S	71	668SRT	18
253-DCI2	16	3ELBR35	26	472S	43	4ELBT30	14	5ACS20	103	669SRT	18
254-DC2	16	3ELBR40	26	472-SLT	43	4ELBT35	14	5ACS30	103	670SRT	18
254-DCI2	16	3ELBT12	14	473i	42	4ELBT40	14	5ACS40	103	671S	27
255-DC2	16	3ELBT15	14	473S	43	500S	43	5ACS50	103	672S	27
255-DCI2	16	3ELBT20	14	473-SLT	43	510BX	21	5ACS60	103	673S	27
256-DC2	16	3ELBT25	14	474i	42	516ALF75	49	5APF30	103	674S	27
256-DCI2	16	3ELBT30	14	474S	43	51-DC	22	5APF40	103	675S	27
257-DC2	16	3ELBT35	14	474-SLT	43	52C0	61	5APF50	103	676S	27
257-DCI2	16	3ELBT40	14	475i	42	52C00	61	5EC35	95	681S	27
258-DC2	16	40ALF08	49	475S	43	52C1	61	5EC40	95	682S	27
258-DCI2	16	40ALF15	49	475-SLT	43	52C10	61	5EC45	95	683S	27
259-DC2	16	40LT08	41	476i	42	52C13	61	5EC50	95	684S	27
259-DCI2	16	413H	60	476S	43	52C14	61	5EC55	95	685S	27
25ALF08	49	4157-DC	51	477S	43	52C14-5/8	61	5EC60	95	686S	27
25ALF15	49	429-SLT	43	478S	43	52C15	61	5EC65	95	700-RA120	90
25LT08	41	430-SLT	43	479S	43	52C16	61	604A	58	700-RA24	90
260-DC	16	431-SLT	43	480S	43	52C17	62	618-NM	52	700-RB120	90
261-DC	16	432-SLT	43	489A	33	52C18	62	618-NMB	52	700-RB24	90
262-DC	16	433-SLT	43	490i	42	52C18-5/8"	62	61-DC	22	700-RC120	90
263-DC	16	434-SLT	43	490S	43	52C3	61	620BP	60	700-RC24	90
264-DC	16	435-SLT	43	491i	42	52C3-1/2	61	620DB	60	700-RG120	90
265-DC	16	4360-DC	43	491S	43	52C49-1/2	62	620Z	60	700-RG24	90
266-DC	16	4361-DC	43	492i	42	52C49-1	62	6256-C	60	700-RLA	91
267-DC	16	437-10-12	88	492S	43	52C49-1¼	62	6258-C	60	700-RLB	91
268-DC	16	437-10-120	88	493i	42	52C49-1½	62	6260-C	60	700-RLC	91
269-DC	16	437-10-24	88	493S	43	52C49-2	62	626B	60	700-RLG	91
280-DC2	22	437-10-6	88	494i	42	52C49-3/4	62	626BS	60	700-RLR	91
281-DC2	22	437-10R-12	88	494S	43	52C52-1	62	626C	60	700-RR120	90
282-DCX	22	437-10R120	88	495i	42	52C52-1/2	62	62-DC	22	700-RR24	90
282-DCX	22	437-10R-24	88	495S	43	52C52-1¼	62	630B	60	716ALF150	49
282-DCX	53	437-10R-6	88	496i	42	52C52-1½	62	630DB	60	716ALF300	49
283-DC	22	437-4-12	88	496S	43	52C52-2	62	63-DC	22	716ALF75	49
30-3RC15/10	99	437-4-120	88	497S	43	52C52-3/4	62	64-DC	22	71-DCA	22
30ALF08	49	437-4-24	88	498S	43	52C6	61	651SIRT	18	71-DCA	33
30ALF15	49	437-4-6	88	4ELBA05	38	52C62	62	651SP	52	72C0	63
30LT08	41	437-4R-12	88	4ELBA07	38	52-DC	22	651SRT	18	72C00	63
330AM	25	437-4R-120	88	4ELBA10	38	530A	32	652SIRT	18	72C1	63
330BM	25	437-4R-24	88	4ELBA12	38	530B	32	652SRT	18	72C10	63
35ALF	49	437-4R-6	88	4ELBA15	38	531AL	39	653-DC2	53	72C13	63
380SP	52	437-6-12	88	4ELBA20	38	532AL	39	653SIRT	18	72C14	63

**NE12-LIST**

Effective Date: August 1, 2010



Catalogue #	Pg.#	Catalogue #	Pg.#	Catalogue #	Pg.#	Catalogue #	Pg.#	Catalogue #	Page #	Catalogue #	Pg.#
72C15	63	802-IFR120	90	870C	55	ALK-40	39	ARIG4020	104	BUS-50	25
72C16	63	802-IFR24	90	9ELBA05	38	ALK-50	39	ARIG4030	104	BUS-60	25
72C17	63	802SP	52	9ELBA07	38	ALK-60	39	ARIG50	104	B-WMBX	89
72C18	63	81-DCA	22	9ELBA10	38	ANP05000	39	ARIG5040	104	B-WPBX	89
72C19	63	81-DCA	33	9ELBA12	38	ANP05015	39	ARIG60	104	BXE-100	57
72C21	63	820D	64	9ELBA15	38	ANP05020	39	ARIG6040	104	BXE-200	57
72C6	63	82-DCA	22	9ELBA20	38	ANP05025	39	ASB-0	49	BXE-300	57
72C62	64	82-DCA	33	9ELBA25	38	ANP05030	39	ASB-1	49	C10GC	66
72-DCA	22	83-DCA	22	9ELBA30	38	ANP05040	39	ASB-2	49	C10M	69
72-DCA	33	83-DCA	33	9ELBA35	38	ANP05050	39	ASB-3	49	C10M-R	69
72R23R	64	8400SP	52	9ELBA40	38	ANP05060	39	ASB-4	49	C1M	69
72R2D	64	840-LA	91	9ELBA50	38	ANP07000	39	ASB-5	49	C-200W	88
7508-C	60	840-LB	91	9ELBA50	38	ANP07020	39	ASB-6	49	C-201WS	88
750A	36	840-LC	91	9ELBA60	38	ANP07025	39	ASB-7	49	C-201WSL	88
750B	36	840-LG	91	9ELBA60	38	ANP07030	39	ASB-8	49	C-202W	88
7510-C	60	840-LR	91	9ELBR05	26	ANP07040	39	B40	104	C-202WL	88
751A	32	840P-SA120	91	9ELBR07	26	ANP07050	39	B-52A-120	90	C2M	69
751i	32	840P-SA18	91	9ELBR10	26	ANP07060	39	B-52B-120	90	C3M	69
752A	32	840P-SB120	91	9ELBR12	26	ANP10000	39	B-52C-120	90	C4M	69
752i	32	840P-SB18	91	9ELBR15	26	ANP10020	39	B-52G-120	90	C4M-R	69
753i	32	840P-SC120	91	9ELBR20	26	ANP10025	39	B-52-LA	91	C5M	69
754i	32	840P-SC18	91	9ELBR25	26	ANP10030	39	B-52-LB	91	C5M-R	69
755i	32	840P-SG120	91	9ELBR30	26	ANP10040	39	B-52-LC	91	C6M	69
756i	32	840P-SG18	91	9ELBR35	26	ANP10050	39	B-52-LG	91	C6M-R	69
757i	32	840P-SR120	91	9ELBR40	26	ANP10060	39	B-52-LR	91	C7GC	66
758i	32	840P-SR18	91	9ELBR50	26	ANP12000	40	B-52R-120	90	C7M	69
759i	32	840T-SA120	91	9ELBR60	26	ANP12020	40	B-874-120	89	C7M-R	69
760i	32	840T-SA18	91	9ELBT05	14	ANP12025	40	B-876-120	89	C8GC	66
800-LA	91	840T-SB120	91	9ELBT07	14	ANP12030	40	BA-07	56	C8M	69
800-LB	91	840T-SB18	91	9ELBT10	14	ANP12040	40	BA-07R	56	C8M-R	69
800-LC	91	840T-SC120	91	9ELBT12	14	ANP12050	40	BC100S	79	C9GC	66
800-LG	91	840T-SC18	91	9ELBT15	14	ANP12060	40	BC100WH	79	C9M	69
800-LR	91	840T-SG120	91	9ELBT20	14	ANP15000	40	BC100Z	79	C9M-R	69
800-ST	91	840T-SG18	91	9ELBT25	14	ANP15020	40	BC200S	79	CA-05	38
800-STA120	91	840T-SR120	91	9ELBT30	14	ANP15025	40	BC200WH	79	CA-07	38
800-STA24	90	840T-SR18	91	9ELBT35	14	ANP15030	40	BC200Z	79	CA-10	38
800-STB120	91	841SP	52	9ELBT40	14	ANP15040	40	BC300S	83	CA-12	38
800-STB24	90	846SP	52	ACD-1	44	ANP15050	40	BELL20	104	CA-15	38
800-STC120	91	84-DCA	22	ACD52	44	ANP15060	40	BELL30	104	CA-20	38
800-STC24	90	84-DCA	33	ACP05	38	ANP20000	40	BELL40	104	CA-25	38
800-STG120	91	850SP	52	ACP07	38	ANP20025	40	BELL50	104	CA-30	38
800-STG24	90	851AL	39	ACP10	38	ANP20030	40	BELL60	104	CA-35	38
800-STR120	91	852AL	39	ACP12	38	ANP20040	40	B-FGPL	89	CA-40	38
800-STR24	90	853AL	39	ACP15	38	ANP20050	40	B-FMBX	89	CA-50	38
801-ISA120	90	854AL	39	ACP20	38	ANP20060	40	B-INTBX	89	CA-60	38
801-ISA24	90	855AL	39	ACP25	38	ANP25000	40	BJ-100	22	CAP10	101
801-ISB120	90	856AL	39	ACP30	38	ANP25030	40	BJ-200	22	CAP15	101
801-ISB24	90	857AL	39	ACP35	38	ANP25040	40	BJ-400	22	CAP20	101
801-ISC120	90	858AL	39	ACP40	38	ANP25050	40	B-MGSK	89	CAP25	101
801-ISC24	90	859AL	39	ACP50	38	ANP25060	40	BRC15/10	99	CAP30	101
801-ISG120	90	860A	28	ACP60	38	ANP30000	40	BRC20-2	100	CAP35	101
801-ISG24	90	860AL	39	ACW-6	44	ANP30030	40	BRC20-3	100	CAP40	101
801-ISR120	90	860B	28	ACW-6C	44	ANP30040	40	B-SFPL	89	CAP45	101
801-ISR24	90	866BLU	55	ACW-8	44	ANP30050	40	BUS-05	25	CAP55	101
802-DC2	50	866BRN	55	ALK-05	39	ANP30060	40	BUS-07	25	CAP60	101
802-IFA120	90	866GRN	55	ALK-07	39	ANP40000	40	BUS-10	25	CAP65	101
802-IFA24	90	866GRY	55	ALK-10	39	ANP40040	40	BUS-12	25	CC-05	66
802-IFB120	90	866ORN	55	ALK-12	39	ANP40050	40	BUS-15	25	CC-07	66
802-IFB24	90	866PUR	55	ALK-15	39	ANP40060	40	BUS-20	25	CC-10	66
802-IFC120	90	866RED	55	ALK-20	39	ARIG20	104	BUS-25	25	CC-12	66
802-IFC24	90	866T	55	ALK-25	39	ARIG30	104	BUS-30	25	CC-15	66
802-IFG120	90	866WHT	55	ALK-30	39	ARIG3020	104	BUS-35	25	CC-20	66
802-IFG24	90	866YEL	55	ALK-35	39	ARIG40	104	BUS-40	25	CCS10	98

**NE12-LIST**

Effective Date: August 1, 2010



Catalogue #	Pg.#	Catalogue #	Pg.#	Catalogue #	Pg.#	Catalogue #	Pg.#	Catalogue #	Pg.#	Catalogue #	Pg.#
CCS15	98	CLB-07	66	DB375S	79	EC9GC	66	ELB10GC	66	FDC101520	99
CCS20	98	CLB-10	66	DB375WH	79	ECM10	107	ELB7GC	66	FDC50	37
CCS25	98	CLB-12	66	DB375Z	79	ECM15	107	ELB8GC	66	FDC75	37
CCS30	98	CLB-15	66	DB550S	79	ECM20	107	ELB9GC	66	FDS101520	99
CCS35	98	CLB-20	66	DB550WH	79	ECM25	107	EMT-05	14	FEMA20	104
CCS40	98	CLL-05	67	DB550Z	79	EE1030	95	EMT-07	14	FEMA30	104
CCS45	98	CLL-07	67	DB575S	79	EE1045	95	EMT-10	14	FEMA40	104
CE-2571	76	CLL-10	67	DB575WH	79	EE1090	95	EMT-12	14	FEMA50	104
CEM1	103	CLL-12	67	DB575Z	79	EE1530	95	EMT-15	14	FEMA60	104
CEM125	103	CLL-15	67	DRC15/10	99	EE1545	95	EMT-20	14	FLEXLTF11	46
CEM250	103	CLL-20	67	DRC20-2	100	EE1590	95	EMT-25	14	FLEXLTF12	46
CEM4	103	CLR-05	67	DRC20-3	100	EE2030	95	EMT-30	14	FLEXLTF13	46
CEM500	103	CLR-07	67	DS-101B	88	EE2045	95	EMT-35	14	FLEXLTF16	46
CG1	71	CLR-10	67	DS-101C	88	EE2090	95	EMT-40	14	FLEXLTF21	46
CG2	71	CLR-12	67	DS-102S	88	EE2530	95	ETD100	23	FLEXLTF34	46
CG3	71	CLR-15	67	DS-103B	88	EE2545	95	ETD1000	23	FLEXLTF38	46
CG4	71	CLR-20	67	DS-103C	88	EE2590	95	ETD125	23	FLEXLTF7	46
CG4	71	CON10005	94	DSDR20-3	100	EE3030	95	ETD150	23	FLEXLTF9	46
CG5	71	CON10007	94	E943DX	101	EE3045	95	ETD200	23	FLEXLTF12	46
CG6	71	CON10010	94	E943EX	101	EE3090	95	ETD50	23	FLEXLTF34	46
CG6	71	CON10012	94	E943FX	101	EE3530	95	ETD75	23	FLEXLTF38	46
CG7	71	CON10015	94	E943GX	101	EE3545	95	EXPJ20	103	FS10	99
CG7	71	CON10020	94	E943HX	101	EE3590	95	EXPJ30	103	FS100	37
CG770-250	48	CON10025	94	E943JX	101	EE4030	95	EXPJ40	103	FS-1000	55
CG770-350	48	CON10030	94	E943KX	101	EE4045	95	EYS-0452	75	FS15	99
CG770-450	48	CON10035	94	E943LX	101	EE4090	95	EYS-0452N	75	FS2-101520	99
CG770-560	48	CON10040	94	E943NX	101	EE4530	95	EYS-0453	75	FS3-101520	99
CG770-650	48	CON10050	94	EB10	102	EE4545	95	EYS-0453N	75	FS50	37
CG771-250	48	CON10060	94	EB15	102	EE4590	95	EYS-0550	75	FS75	37
CG771-350	48	CP5050S	83	EB20	102	EE5030	95	EYS-0550N	75	FSC10	99
CG771-450	48	CP5075S	83	EB25	102	EE5045	95	EYS-2633	75	FSC100	37
CG771-560	48	CR2012	98	EB30	102	EE5090	95	EYS-2633N	75	FSC15	99
CG771-650	48	CR3020	98	EB35	102	EE5530	95	EYS-2634	75	FSC2-101520	99
CG771-750	48	CR3025	98	EB40	102	EE5545	95	EYS-2634N	75	FSC3-101520	99
CG771-850	48	CR4020	98	EB45	102	EE5590	95	EYS-2635	75	FSC50	37
CG772-1050	48	CR4025	98	EB50	102	EE6030	95	EYS-2635N	75	FSC75	37
CG772-560	48	CR4030	98	EB55	102	EE6045	95	FA10	94	FSCC10	99
CG772-650	48	CS10-1	98	EB60	102	EE6090	95	FA15	94	FSCC15	99
CG772-750	48	CS15-1	98	EB65	102	EE6530	95	FA20	94	FSCC2-101520	99
CG772-850	48	CS20-1	98	EC-075	22	EE6545	95	FA25	94	FSFDCG	37
CG772-950	48	CS25-1	98	EC10	94	EE6590	95	FA30	94	FSFDCM1	37
CGA770-250	48	CS30-1	98	EC-100	22	EF10	97	FA35	94	FSFDCM2	37
CGA770-350	48	CS35	98	EC10GC	66	EF15	97	FA40	94	FSFDCM3	37
CGA770-450	48	CS35-1	98	EC-125	22	EF20	97	FA-400	21	FSS10	99
CGA770-560	48	CS40	98	EC15	94	EF25	97	FA-401	21	FSS15	99
CGA770-650	48	CS40-1	98	EC-150	22	EF30	97	FA-402	21	FSS2-101520	99
CGA771-250	48	CS45	98	EC20	94	EF35	97	FA-403	21	G15	60
CGA771-350	48	CS45-1	98	EC-200	22	EF40	97	FA-404	21	G16	60
CGA771-450	48	CS50	98	EC25	94	EF45	97	FA-411	21	G3	60
CGA771-560	48	CS50-1	98	EC-250	22	EF50	97	FA45	94	G4	60
CGA771-650	48	CS55	98	EC30	94	EF55	97	FA50	94	GASK DD	100
CGA771-750	48	CS55-1	98	EC-300	22	EJ10	102	FA55	94	GASK W	100
CGA771-850	48	CS60	98	EC35	94	EJ15	102	FA60	94	GASK15/10	99
CGA772-1050	48	CS65	98	EC-350	22	EJ20	102	FA65	94	GASK20-2	100
CGA772-560	48	CT-05	67	EC40	94	EJ25	102	FB-10	76	GASK20-3	100
CGA772-650	48	CT-07	67	EC-400	22	EJ30	102	FD100	37	GASKV20-2	100
CGA772-750	48	CT-10	67	EC45	94	EJ35	102	FD-2	99	GF38SP	52
CGA772-850	48	CT-12	67	EC50	94	EJ40	102	FD-3	99	GP1016	60
CGA772-950	48	CT-15	67	EC55	94	EJ45	102	FD347	99	GP-501	88
CH100S	80	CT-20	67	EC60	94	EJ50	102	FD50	37	GP-502	88
CH100WH	80	DB350S	79	EC65	94	EJ55	102	FD75	37	GP-503	88
CH100Z	80	DB350WH	79	EC7GC	66	EJ60	102	FD-C	99	GP-504	88
CLB-05	66	DB350Z	79	EC8GC	66	EJ65	102	FDC100	37	GP-505	88

**NE12-LIST**

Effective Date: August 1, 2010



Catalogue #	Pg.#	Catalogue #	Pg.#	Catalogue #	Pg.#	Catalogue #	Page #	Catalogue #	Pg.#	Catalogue #	Pg.#
GPC-05	58	H887-A	101	KASTB30	108	LB4M-R	69	LPMF150C	109	MX1250S	80
GPC-07	58	HAS-015K	102	KC10	107	LB5M	69	LR10GC	67	MX2050S	80
GPC-10	58	HG751	102	KC15	107	LB5M-R	69	LR10M	70	MX2150S	79
GPC1016	60	JB10124	102	KC20	107	LB6M	69	LR10M	70	MX3200S	81
GPC-12	58	JB121212	102	KC25	107	LB6M-R	69	LR1M	70	MX3300S	81
GPC-15	58	JB12124	101	KC30	107	LB7GC	66	LR2M	70	MX6200S	81
GPC-20	58	JB12126	101	KC35	107	LB7M	69	LR3M	70	NLN12B	46
GPC-25	58	JB12128	101	KO07	100	LB7M-R	69	LR4M	70	NLN12G	46
GPC-30	58	JB16166	102	KO10	100	LB8GC	66	LR5M	70	NLN1B	46
GPC-35	58	JB16168	102	KO50	23	LB8M	69	LR6M	70	NLN1G	46
GPC-40	58	JB181810	102	KO51	23	LB8M-R	69	LR7GC	67	NLN34B	46
GR6256	60	JB181812	102	KO52	23	LB9GC	66	LR7M	70	NLN34G	46
GR6258	60	JB18186	102	KO53	23	LB9M	69	LR8GC	67	NLN38B	46
GR6260	60	JB18188	102	KO54	23	LB9M-R	69	LR8M	70	NLN38G	46
GR7508	60	JB202012	102	KO55	23	LC2-100	54	LR9GC	67	NMCB-1	56
GR7510	60	JB20208	102	KOS-100	23	LC3-100	54	LR9M	70	NMCB-2	56
GRB-0445	74	JB242410	102	KOS-100-VT	23	LC3-300B	54	LTF1	46	NMCB-3	56
GRB-0446	74	JB242412	102	KOS-125	23	LC3-300R	54	LTF11	46	NMLV-100B	57
GRB-0584	74	JB24244	102	KOS-125-VT	23	LC4-100	54	LTF12	46	NMLV-100F	57
GRB-0597	74	JB24246	102	KOS-150	23	LC4-250B	54	LTF13	46	NMLV-200F	57
GRB-0600	74	JB24248	102	KOS-150-VT	23	LG150T	109	LTF16	46	NMV-200B	57
GRB-0605	74	JB30188	102	KOS-200	23	LH100S	83	LTF21	46	NMWH-43	56
GRC-0443	74	JB303010	102	KOS-200-VT	23	LHS100W	83	LTF29	46	NP05000	30
GRC-0444	74	JB303012	102	KOS-250	23	LHS100Z	83	LTF34	46	NP05015	30
GRC-0556	74	JB30308	102	KOS-250-VT	23	LK-05	24	LTF38	46	NP05020	30
GRC-0561	74	JB36248	102	KOS-300	23	LK-07	24	LTF7	46	NP05025	30
GRC-0580	74	JB363610	102	KOS-300-VT	23	LK-10	24	LTF9	46	NP05030	30
GRC-0589	74	JB363612	102	KOS-350	23	LK-12	24	LTS100S	83	NP05035	30
GRE-0447	74	JB363614	102	KOS-350-VT	23	LK-15	24	LTS100WH	83	NP05040	30
GRE-0448	74	JB36368	102	KOS-400	23	LK-20	24	LTS100Z	83	NP05045	30
GRE-0582	74	JB442	101	KOS-400-VT	23	LK-25	24	LV310S	83	NP05050	30
GRE-0587	74	JB444	101	KOS-50	23	LK-30	24	LV310Z	83	NP05060	30
GRE-0598	74	JB446	101	KOS-500	23	LK-35	24	LV330S	83	NP05080	30
GRE-0603	74	JB552	101	KOS-500-VT	23	LK-38	24	LV330WH	83	NP05100	30
GRL-0439	74	JB664	101	KOS-50-VT	23	LK-40	24	LV330Z	83	NP05120	30
GRL-0440	74	JB666	101	KOS-600	23	LK-50	24	LV330Z	83	NP07000	30
GRL-0546	74	JB884	101	KOS-600-VT	23	LK-60	24	LVB-1	57	NP07015	30
GRL-0558	74	JB887	101	KOS-75	23	LL10GC	67	LVPB 150	109	NP07020	30
GRL-0576	74	JBA10	101	KOS-75-VT	23	LL1M	70	LVPE150-10/15	109	NP07025	30
GRL-0591	74	JBA15	101	KTA10	107	LL2M	70	LVPF150C	108	NP07030	30
GRT-0441	74	JBA20	101	KTA15	107	LL3M	70	LVPG 150	109	NP07035	30
GRT-0442	74	JBA25	101	KTA20	107	LL4M	70	LVPUG150	109	NP07040	30
GRT-0547	74	JBA30	101	KTA25	107	LL5M	70	LWB 150	109	NP07045	30
GRT-0559	74	JBA35	101	KTA30	107	LL6M	70	LWMF150C	109	NP07050	30
GRT-0578	74	JBA40	101	KTA35	107	LL7GC	67	MHU25	97	NP07060	30
GRT-0593	74	JBA45	101	KTC10	107	LL7M	70	MHU30	97	NP07080	30
GRX-0449	74	JBA50	101	KTC15	107	LL8GC	67	MHU35	97	NP07100	30
GRX-0450	74	JBA60	101	KTC20	107	LL8M	70	MHU40	97	NP07120	30
GRX-0585	74	JC10-100	54	KTS10	107	LL9GC	67	MHU45	97	NP10000	30
GRX-0595	74	JC10-100-SS	54	KTS15	107	LL9M	70	MK-10020	36	NP10020	30
GRX-0601	74	JC10-250B	54	KTS20	107	LLR-41	66	MK-20025	36	NP10025	30
GRX-0606	74	JC10-250R	54	KWBC-10	108	LLR-42	66	MK-20025R	36	NP10030	30
GRXZ-0468	74	JC10-50	54	L-16	52	LLR-43	66	ML400G	82	NP10035	30
GRXZ-0469	74	JC12-300B	54	L-17	52	LLR-44	66	ML450G	82	NP10040	30
GRXZ-0586	74	JC12-300R	54	L-18	52	LLR-45	66	MLB-47	71	NP10045	30
GRXZ-0596	74	JC12-50	54	L-19	52	LLR-46	66	MLB-48	71	NP10050	30
GRXZ-0602	74	JC14-100	54	LB10GC	66	LMO12-EMT	14	MLB-49	71	NP10060	30
GRXZ-0607	74	K149123A	91	LB10M	69	LMO15-EMT	14	MLB-50	71	NP10080	30
H664	101	K149130A	91	LB10M-R	69	LMO20-EMT	14	MM2410C	82	NP10100	30
H666	101	KASTB10	108	LB1M	69	LMO25	97	MM410C	82	NP10120	30
H884	101	KASTB15	108	LB2M	69	LMO30	97	MO25	97	NP12000	30
H886	101	KASTB20	108	LB3M	69	LMO35	97	MO35	97	NP12020	30
H887	101	KASTB25	108	LB4M	69	LPC 150	109	MX1050S	80	NP12025	30

## NE12-LIST

Effective Date: August 1, 2010



Catalogue #	Pg.#	Catalogue #	Pg.#	Catalogue #	Pg.#	Catalogue #	Pg.#	Catalogue #	Pg.#	Catalogue #	Pg.#
NP12030	30	NP50060	31	PBC200GY	85	RB3012	34	RTSC-12	17	RW4005	35
NP12035	30	NP50100	31	PBC300GY	85	RB3015	34	RTSC-15	17	RW4007	35
NP12040	30	NP50120	31	PCP47550GY	85	RB3020	34	RTSC-20	17	RW4010	35
NP12050	30	NP60000	31	PDB77550GY	85	RB3025	34	RTSC-25	17	RW4012	35
NP12060	30	NP60050	31	PE15/10	96	RB3515	34	RTSC-30	17	RW4015	35
NP12080	30	NP60060	31	PE15/10	96	RB3520	34	RTSC-35	17	RW4020	35
NP12100	30	NP60100	31	PFC020	103	RB3525	34	RTSC-40	17	RW4025	35
NP12120	30	NP60120	31	PFC030	103	RB3530	34	RTSCI-05	17	RW4030	35
NP15000	31	NSL2-24	95	PFC040	103	RB4020	34	RTSCI-07	17	RW4035	35
NP15020	31	NSL2-36	95	PFC050	103	RB4025	34	RTSCI-10	17	RWDR15/10	100
NP15025	31	NSL3-24	95	PFC060	103	RB4030	34	RTSCI-12	17	RWDRE15/10	100
NP15030	31	NSL3-36	95	PL-210	54	RB4035	34	RTSCI-15	17	RWGF15/10	100
NP15035	31	NSL4-36	95	PLTS100GY	83	RB550S	83	RTSCI-20	17	S10	54
NP15040	31	NSL4-48	95	PLTS100GY	85	RB550WH	83	RTSCI-25	17	SB100S	78
NP15050	31	NSL5-36	95	PLTS100WH	83	RB550Z	83	RTSCI-30	17	SB100S	78
NP15060	31	NSL6-36	95	PLUG20	104	RB575S	83	RTSCI-35	17	SB109313	59
NP15080	31	OB20	100	PLUG30	104	RB575WH	83	RTSCI-40	17	SB109314	59
NP15100	31	OB401507	100	PLUG40	104	RB575Z	83	RTSCP-05	17	SB109315	59
NP15120	31	P470	45	PLUG50	104	RC3020	103	RTSCP-07	17	SB137514	59
NP20000	31	P470B	45	PLUG60	104	RC3520	103	RTSCP-10	17	SB137516	59
NP20025	31	P471	45	PLV330GY	85	RC3530	103	RTSCP-12	17	SB175022	59
NP20030	31	P471B	45	POLAR250	55	RC4020	103	RTSCP-15	17	SB2.531	59
NP20035	31	P472	45	PRB57550GY	85	RC4030	103	RTSCP-20	17	SB200026	59
NP20040	31	P472B	45	PRIM250	103	RC4035	103	RTSCP-25	17	SB3.039	59
NP20050	31	P473	45	PRIM500	103	RC5040	103	RTSCP-30	17	SB3.547	59
NP20060	31	P473B	45	PS10	97	RC6040	103	RTSCP-35	17	SB350S	78
NP20080	31	P474	45	PS15	97	RC75	52	RTSCP-40	17	SB350WH	78
NP20100	31	P474B	45	PS20	97	RC75J	52	RW0705	35	SB350Z	78
NP20120	31	P475	45	PS25	97	RCP05	27	RW1005	35	SB375S	78
NP25000	31	P475B	45	PS30	97	RCP07	27	RW1007	35	SB375WH	78
NP25030	31	P476	45	PS35	97	RCP10	27	RW1205	35	SB375Z	78
NP25035	31	P476B	45	PS40	97	RCP12	27	RW1207	35	SB4.055	59
NP25040	31	P490	45	PS45	97	RCP15	27	RW1210	35	SB450S	78
NP25050	31	P490B	45	PS55	97	RCP20	27	RW1505	35	SB450WH	78
NP25060	31	P491	45	PSB37550GY	85	RCP25	27	RW1507	35	SB450Z	78
NP25080	31	P491B	45	PT-123	56	RCP30	27	RW1510	35	SB475S	78
NP25100	31	P492	45	PT-123B	56	RCP35	27	RW1512	35	SB475WH	78
NP25120	31	P492B	45	PTC100GY	85	RCP40	27	RW2005	35	SB475Z	78
NP30000	31	P493	45	PTC200GY	85	RCP50	27	RW2007	35	SB550S	78
NP30030	31	P493B	45	PTC521GY	85	RCP60	27	RW2010	35	SB550WH	78
NP30035	31	P494	45	PTW-1/2	54	RIG-05	26	RW2012	35	SB550XS	78
NP30040	31	P494B	45	PTW-3/8	54	RIG-07	26	RW2015	35	SB550Z	78
NP30050	31	P495	45	PTW-5/16	54	RIG-10	26	RW2505	35	SB575S	78
NP30060	31	P495B	45	RB0538	34	RIG-12	26	RW2507	35	SB575WH	78
NP30080	31	P496	45	RB0705	34	RIG-15	26	RW2510	35	SB575XS	78
NP30100	31	P496B	45	RB1005	34	RIG-20	26	RW2512	35	SB575Z	78
NP30120	31	PB-301	89	RB1007	34	RIG-25	26	RW2515	35	SB87510	59
NP35000	31	PB-301N	89	RB1205	34	RIG-30	26	RW2520	35	SB87511	59
NP35040	31	PB-302	89	RB1207	34	RIG-35	26	RW3005	35	SB8756	59
NP35050	31	PB-303	89	RB1210	34	RIG-40	26	RW3007	35	SB8757	59
NP35060	31	PB-304	89	RB1505	34	RIG-50	26	RW3010	35	SB8758	59
NP35080	31	PB-305B	89	RB1507	34	RIG-60	26	RW3012	35	SB8759	59
NP35100	31	PB-305BL	89	RB1510	34	RLTF34	46	RW3015	35	SC-05	16
NP35120	31	PB-305C	89	RB1512	34	RLTF38	46	RW3020	35	SC-07	16
NP40000	31	PB-305CL	89	RB2005	34	RS11	64	RW3025	35	SC-10	16
NP40040	31	PB-306B	89	RB2007	34	RS12	64	RW3505	35	SC100S	96
NP40050	31	PB-306C	89	RB2010	34	RS2	64	RW3507	35	SC10S	96
NP40060	31	PB-307GL	89	RB2012	34	RS5	64	RW3510	35	SC-12	16
NP40080	31	PB-307W	89	RB2015	34	RS8	64	RW3512	35	SC-15	16
NP40100	31	PB-307WL	89	RB2510	34	RS9	64	RW3515	35	SC-20	16
NP40120	31	PB-308BL	89	RB2512	34	RTSC-05	17	RW3520	35	SC20S	96
NP50000	31	PB-308CL	89	RB2515	34	RTSC-07	17	RW3525	35	SC-25	16
NP50050	31	PBC100GY	85	RB2520	34	RTSC-10	17	RW3530	35	SC-30	16

**NE12-LIST**

Effective Date: August 1, 2010



Catalogue #	Pg.#	Catalogue #	Pg.#	Catalogue #	Pg.#	Catalogue #	Pg.#	Catalogue #	Page #	Catalogue #	Pg.#
SC30S	96	SLB10S	96	SRC-400	29	TA45	94	UNY-3S	76		
SC-35	16	SLB20S	96	SRC-500	29	TA50	94	UPP35	105		
SC-40	16	SLB30S	96	SRC-600	29	TA55	94	UPP45	105		
SC40S	96	SLB40S	96	SSBH-10	108	TA60	94	UPP55	105		
SC-5075HF	56	SLB50S	96	SSBH-10/15	108	TA65	94	UPP60	105		
SC-5075HFR	56	SLB60S	96	SSBH-15	108	TB1M	70	UPP65	105		
SC50S	96	SLB70S	96	ST100S	97	TB2M	70	VFI100W50	84		
SC60S	96	SLB80S	96	ST10S	97	TB3M	70	VFI100W50CG	84		
SC70S	96	SLB90S	96	ST20S	97	TB4M	70	VFI100W50CG	84		
SC80S	96	SLL100S	96	ST30S	97	TB5M	70	VFI100W75	84		
SC90S	96	SLL10S	96	ST40S	97	TB6M	70	VFI100W75CG	84		
SCI-05	16	SLL20S	96	ST50S	97	TC100S	79	VFIBOX50	84		
SCI-07	16	SLL30S	96	ST60S	97	TC200S	79	VFIBOX75	84		
SCI-10	16	SLL40S	96	ST70S	97	TERM40H	104	VFICC	84		
SCI-12	16	SLL50S	96	ST80S	97	TERM40W	104	VFIGGC	84		
SCI-15	16	SLL60S	96	ST90S	97	TP10	107	VFIGLS	84		
SCI-20	16	SLL70S	96	STB10S	97	TP15	107	VFP100W75CG	84		
SCI-25	16	SLL80S	96	STB20S	97	TP20	107	VFW100W50CG	84		
SCI-30	16	SLL90S	96	STB30S	97	TR-025	58	VFW100W75CG	84		
SCI-35	16	SLR100S	96	STB40S	97	TR-038	58	VPT15/10	100		
SCI-40	16	SLR10S	96	STB50S	97	TR-050	58	VSC15/10	100		
SCP-05	17	SLR20S	96	STB60S	97	TRC-05	28	VSC20-2	100		
SCP-07	17	SLR30S	96	SWC020	103	TRC-07	28	VSDD20-2	100		
SCP-10	17	SLR40S	96	SWC030	103	TRC-10	28	VSDR20-2	100		
SCP-12	17	SLR50S	96	SWC040	103	TRC-12	28	VSGG20-2	100		
SCP-15	17	SLR60S	96	SWC050	103	TRC-15	28	VSRC20-2	100		
SCP-20	17	SLR70S	96	SWC060	103	TRC-20	28	VSRR20-2	100		
SCP-25	17	SLR80S	96	SWCA20	104	TRC-25	28	WDR15/10	100		
SCP-30	17	SLR90S	96	SWCA30	104	TRC-30	28	WDRE15/10	100		
SCP-35	17	SLT-05	45	SWCA40	104	TRC-35	28	WGF15/10	100		
SCP-40	17	SLT-07	45	SWCA50	104	TRC-40	28	WPH-1G	83		
SD350S	78	SLT9-05	45	SWCA60	104	TRC-50	28	WTG15/10	100		
SD350WH	78	SLT9-07	45	T10GC	67	TRC-60	28	WTL15	100		
SD350Z	78	SMB-10	108	T10M	70	TRP-05	28	WTL20	100		
SD375S	78	SMB-10/20	108	T1M	70	TRP-07	28	WTL30	100		
SD375WH	78	SMB-H-10	108	T2M	70	TRP-10	28	WTL50	100		
SD375Z	78	SMB-H-10/15	108	T3M	70	TRP-12	28	XR20	100		
SD450S	78	SMB-H-10/20	108	T4M	70	TRP-15	28	XR35	100		
SD475S	78	SMB-H-15	108	T5M	70	TRP-20	28				
SDR-05	110	SMB-H-15/20	108	T-601	89	TRP-25	28				
SDR-07	110	SPLY20	104	T-602	89	TRP-30	28				
SDR-10	110	SPLY30	104	T-603	89	TRP-40	28				
SDR-12	110	SPLY40	104	T-604	89	TRP-50	28				
SDR-15	110	SR-05	24	T6M	70	TRP-60	28				
SDR-20	110	SR-07	24	T7GC	67	TSC15/10	99				
SDR-30	110	SR-10	24	T7M	70	TSC20-2	100				
SDR-40	110	SR-12	24	T8GC	67	TSC20-3	100				
SE100S	96	SR-15	24	T8M	70	TSDC20-2	100				
SE10S	96	SR-20	24	T9GC	67	TSDC20-3	100				
SE20S	96	SR-25	24	T9M	70	TSRC10	100				
SE30S	96	SR-30	24	TA10	94	TSRC15	100				
SE40S	96	SR-35	24	TA15	94	TU-2992	75				
SE50S	96	SR-40	24	TA20	94	TU-2993	75				
SE60S	96	SRC-050	29	TA25	94	TU-2994	75				
SE70S	96	SRC-075	29	TA-2636	75	TU-2995	75				
SE80S	96	SRC-100	29	TA-2637	75	TU-2996	75				
SE90S	96	SRC-125	29	TA-2937	75	TU-2997	75				
SE-J-35	102	SRC15	100	TA-2938	75	TW16	56				
SE-J-45	102	SRC-150	29	TA-2943	75	UNF-1S	76				
SE-J-55	102	SRC-200	29	TA-2997	75	UNF-2S	76				
SG38ASP	52	SRC-250	29	TA30	94	UNF-3S	76				
SG38SP	52	SRC-300	29	TA35	94	UNY-1S	76				
SLB100S	96	SRC-350	29	TA40	94	UNY-2S	76				





## TECHNICAL SPECIFICATIONS

Trade Size (nominal)	I.D.	O.D.	
	(nominal)	Min.	Max.
<b>E.M.T.</b>			
1/2"	0.622	0.701	0.711
3/4"	0.824	0.917	0.927
1"	1.049	1.158	1.168
1-1/4"	1.380	1.505	1.515
1-1/2"	1.610	1.735	1.745
2"	2.067	2.192	2.202
2-1/2"	2.731	2.865	2.885
3"	3.356	3.485	3.515
3-1/2"	3.834	3.900	4.020
4"	4.334	4.480	4.520

Trade Size (nominal)	I.D. (nominal)	O.D. (nominal)	Number of threads per in.
<b>Rigid Metal Conduit</b>			
3/8"	0.492	0.673	18
1/2"	0.622	0.840	14
3/4"	0.824	1.050	14
1"	1.049	1.315	11-1/2
1-1/4"	1.380	1.660	11-1/2
1-1/2"	1.610	1.900	11-1/2
2"	2.067	2.375	11-1/2
2-1/2"	2.469	2.875	8
3"	3.068	3.500	8
3-1/2"	3.548	4.000	8
4"	4.026	4.500	8
5"	5.047	5.563	8
6"	6.065	6.626	8

KO Trade Size (in.)	Metric Designators (mm)
3/8"	12
1/2"	16
3/4"	21
1"	27
1-1/4"	35
1-1/2"	41
2"	53
2-1/2"	63
3"	78
3-1/2"	91
4"	103
5"	129
6"	155

Trade Size (nominal)	I.D. (Min.)	O.D. (Max.)
<b>Liquid-tight Flex. Metal Conduit</b>		
3/8"	0.484	0.710
1/2"	0.622	0.840
3/4"	0.820	1.050
1"	1.041	1.315
1-1/4"	1.380	1.660
1-1/2"	1.575	1.900
2"	2.020	2.375
2-1/2"	2.480	2.875
3"	3.070	3.500
3-1/2"	3.500	4.000
4"	4.000	4.500

Trade Size (nominal)	I.D. (Min.)	O.D. (Max.)
<b>PVC Conduit</b>		
1/2"	0.574	0.848
3/4"	0.778	1.060
1"	1.000	1.325
1-1/4"	1.25	1.672
1-1/2"	1.500	1.912
2"	2.000	2.387
2-1/2"	2.413	2.890
3"	3.000	3.515
3-1/2"	3.480	4.015
4"	3.941	4.515
5"	4.955	5.593
6"	5.896	6.660

Trade Size (nominal)	I.D. (Min.)	O.D. (Max.)
<b>Flexible Metal Conduit</b>		
5/16"	0.312	0.510
3/8"	0.375	0.610
7/16"	0.437	0.675
1/2"	0.625	0.920
3/4"	0.812	1.105
1"	1.000	1.380
1-1/4"	1.250	1.630
1-1/2"	1.500	1.950
2"	2.000	2.540
2-1/2"	2.500	3.060
3"	3.000	3.560
3-1/2"	3.500	4.060
4"	4.000	4.560

### Conversion Factors

#### **Length**

inch x 25.40 = millimeter

millimeter x 0.03937 = inch

#### **Volume**

cubic inch x 16.39 = millimeter or cubic centimeter

millimeter or cubic centimeter x 0.06102 = cubic inch

#### **Mass**

Pound x 0.4536 = Kilogram

Kilogram x 2.205 = Pound

#### **Temperature**

(°F - 32) / 1.8 = °C

(°C x 1.8) + 32 = °F



# NESCO<sup>®</sup> INC.

216 Wilkinson Road, Brampton, Ontario L6T 4M4  
Tel: (905) 793-2218 Fax: (905) 793-2268



Toll Free !!!

**1 (866) 446-3726**

## REPRESENTED BY:

Atlantic

### **S&D Marketing Limited**

48 Trider Cresent, Unit 6  
Dartmouth, Nova Scotia B3B 1R6

Tel: (902) 835-1532  
Fax: (902) 835-1402

Contact: Dave Flemming - dave@sdmarketing.ca  
Derek Johnston - derek@sdmarketing.ca

cell # (902) 499-8599  
cell # (902) 233-5888

Quebec

### **MGB Agent Manufacturier Inc.**

1310 Blvd. des Chutes #410  
Quebec, QC G1E 0B6

Tel: (418) 614-1908  
Fax: (418) 948-9132

Contact: Michel Berthiaume - mgb.inc@videotron.ca cell # (418) 569-8230

NW Ontario  
Manitoba

### **GB Agencies Ltd.**

43 Red Moon Road  
Winnipeg, MB R3X 0C2

Tel: (204) 219-3160  
Fax: (204) 219-3087

Contact: Gary Beer - gary@gbagencies.com  
Geoff Ginn - geoff@gbagencies.com

cell # (204) 330-1601  
cell # (204) 330-0100

Alberta  
Saskatchewan

### **Roblan Cook Agencies Ltd.**

5030 13th Street, Unit 19  
Calgary, Alberta T2G 5M9

Tel: (403) 214-2077  
Fax: (403) 214-2081

Contact: Del Cook - delcook@telus.net

cell # (403) 651-1122

British Columbia

### **C.R. Browne & Associates**

#8-16325 82<sup>nd</sup> Ave,  
Surrey, British Columbia V4N 0P5

Tel: (604) 591-3340  
Fax: (604) 591-2294

Contact: Craig Browne - craig@crbrowne.com  
Brian Vulcano - brian@crbrowne.com

cell # (604) 720-2722  
cell # (604) 308-7741