

PHILIPS ADVANCE



LED Driver

Xitanium

100W 120~277V 4.16A Fixed
LEDINTA0024V41FO



Long-lasting and low maintenance, LED-based light sources are an excellent solution for all lighting applications. For optimal performance, these solutions require reliable drivers matching the long lifetime of the LEDs. The Philips Advance Xitanium LED Outdoor Driver portfolio offers a range of products specially designed to operate LED solutions in outdoor applications. These drivers are designed for hard-wired integration into outdoor luminaires for the most rugged applications. They operate to specification under wide temperature and electrical ranges to ensure reliability.

Specifications

Input Voltage (Vrms)	Output Power (W)	Output Voltage (V)	Output Current (A)	Efficiency@ Max Load and 70°C Case	Max. Case Temp. (°C)	Input Current (Arms)	Max. Input Power (W)	Inrush Current ($A_{in}/10\%-\mu s$)	THD @ Max. Load	Power Factor @ Max. Load	Surge Protection Common/ Diff (KV)	Weight (Lbs/kgs)	Envir. Protection Rating
120	100	24 cv	0.10~4.16A cv 4.16A cc	86	90	0.95	116	36/228	<20%	>0.90	4/4	1.4/ 0.635	UL Dry & Damp
277		6~24 cc		88		0.40		84/216					

Enclosure

	In. (mm)
Case Length	8.34 (212.00)
Case Width	1.70 (43.00)
Case Height	1.18 (30.00)
Mounting Length	9.45 (240.00)
Mounting Width	1.22 (31.00)
Overall Length	9.45 (240.00)

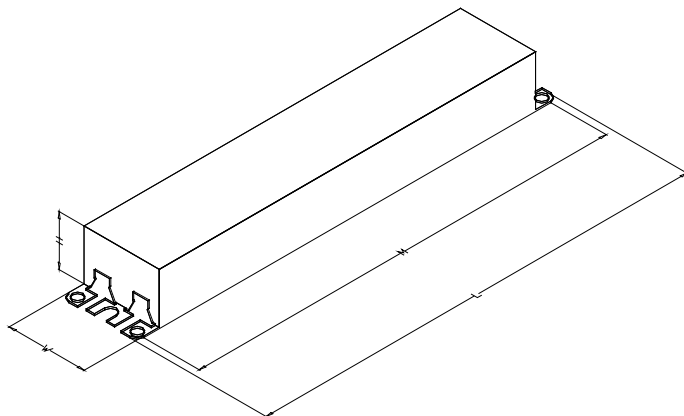

Wiring Diagram

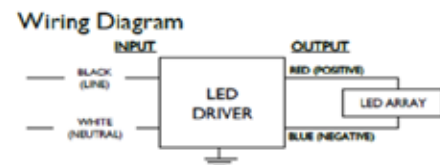

Input and output use lead-wires.

Lead-wires are 18AWG 105C/600V solid copper.

Standard Lead Length

	in.	cm.
Black	9	22
White	9	22
Blue	26	66
Red	26	66

UL Conditions of Acceptability:

Please contact your Philips representative for a copy of the latest UL Conditions of Acceptability (COA).

Xitanium 100W 120-277V 4.16A Fixed Output

Electrical Specifications

All the specifications are typical and at 25°C Tcase unless specified otherwise.

Features

- 50,000+ hour lifetime¹
- Isolated 0-10V dimming
- New housing with high thermal capability

Benefits

- Enables long life luminaire designs
- Helps to maximize energy savings and allows application specific light levels
- Allows luminaire designs for ambient environments

Application

- Area
- Roadway
- Parking garages
- Floodlights

1. Philips Advance Xitanium LED Drivers are designed and manufactured to engineering standards correlating to an average life expectancy of 50,000 hours of operation at maximum rated case temperature. Minimum 90% survivals based on MTBF modeling.

Product Data

Order Information	
Order Code	LEDINTA0024V41FO
Full Product Code	LEDINTA0024V41FOM (Mid-Pack, 20pcs/Box)
Full Product Name	XITANIUM 100W 24V 4.16A 120-277V
Line Voltage	120-277Vac_rms
Line Current	0.95A @ 120V, 0.4A @ 277V
Line Frequency	50/60Hz
Min. Mains Voltage Operational	108V
Max. Mains Voltage Operational	305V
THD (total)	Refer to graph
Power Factor (PF)	Refer to graph
Efficiency	Refer to graph
Inrush Current	Per NEMA 410
Lightning Surge Protection	Refer to table
Output Information	
Output Voltage Range	6Vdc to 24Vdc
Maximum Open Circuit Voltage	25Vdc
Output Current (ripple = peak to average / average)	15% max @ max Iout and max Vout Low frequency (≤ 120 Hz) content $< 5\%$
Protections	Short Circuit and Open Circuit Protection for LED + and LED -
Operating Ambient Temp. Range	-40C to +55°C
Max Case Temperature (Tcase)	90°C
Features	
Interfaces	None
0-10V Dimming Specifications	NA
Environment & Approbation	
Environmental Protection Rating	UL damp and dry, Type HL
Agency Approbations	UL8750, UL1310, UL935, CSA-C22.2 No. 250.13-12, CSA C22.2 No. 223, CE, ENEC
Electromagnetic Compliance	FCC Title 47 Part 15 Class A, EN 55015-Conducted and radiated emission.
Isolation	Refer to table
Audible Noise	< 24 dB Class A

Xitanium 100W 120-277V 4.16A Fixed Output

Performance Characteristics

Based on measurements on a typical sample. The accuracy of the measurements is within the tolerance of the measurement instruments. The graphs are meant to be a guideline and not a specification.

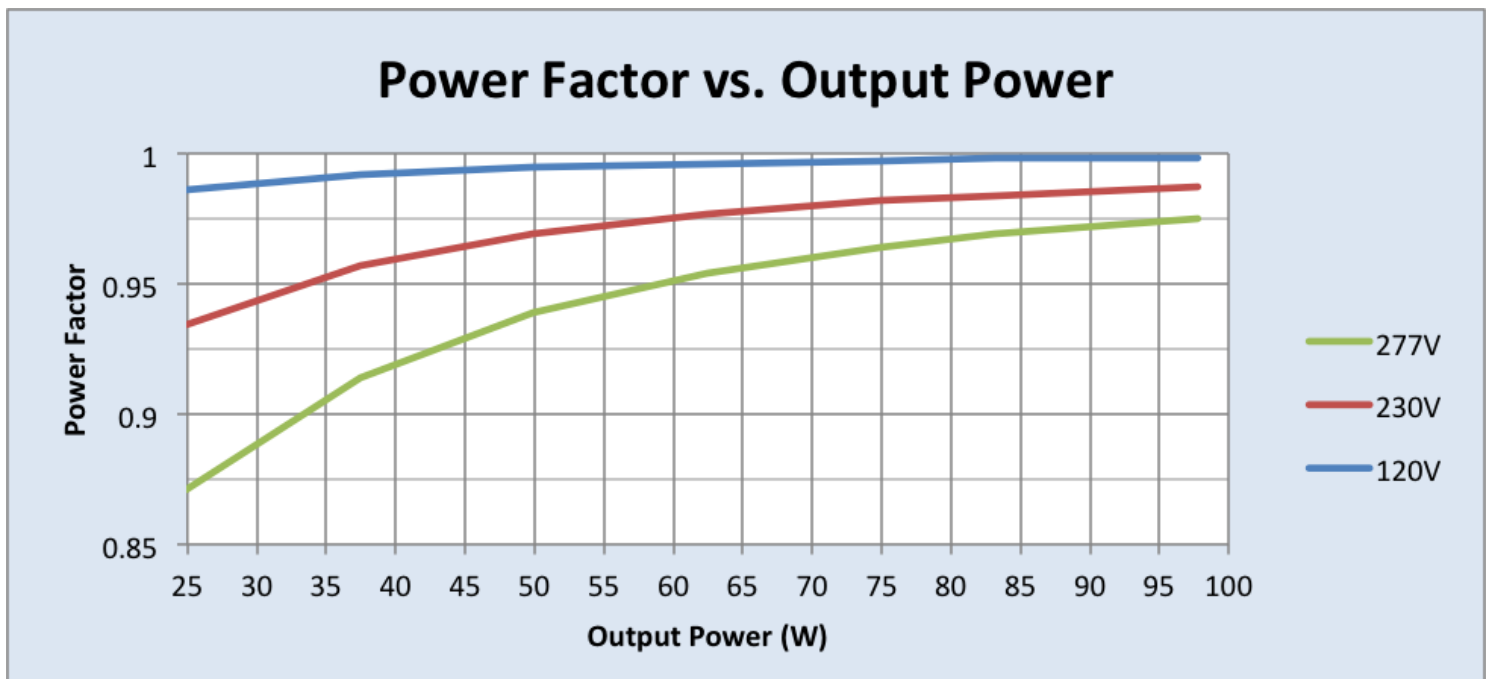
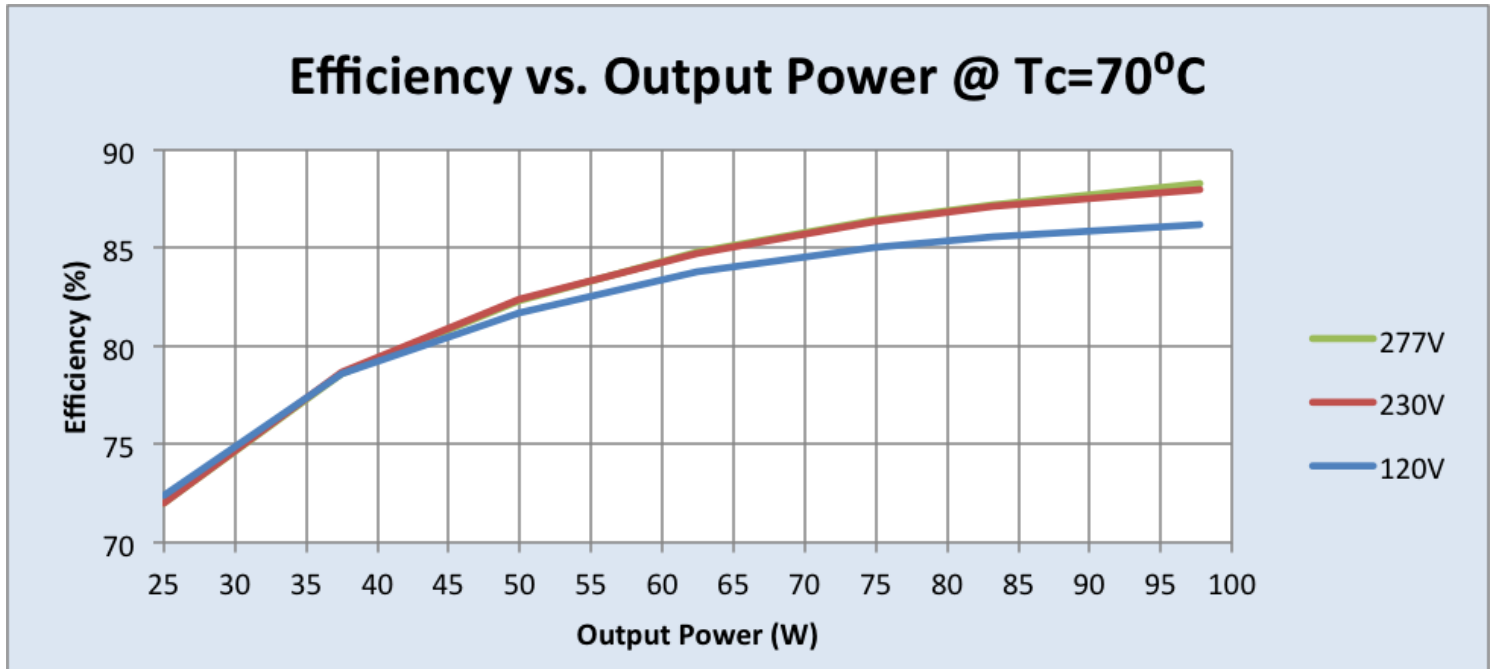

Xitanium 100W 120-277V 4.16A Fixed Output

Performance Characteristics

Based on measurements on a typical sample. The accuracy of the measurements is within the tolerance of the measurement instruments. The graphs are meant to be a guideline and not a specification.

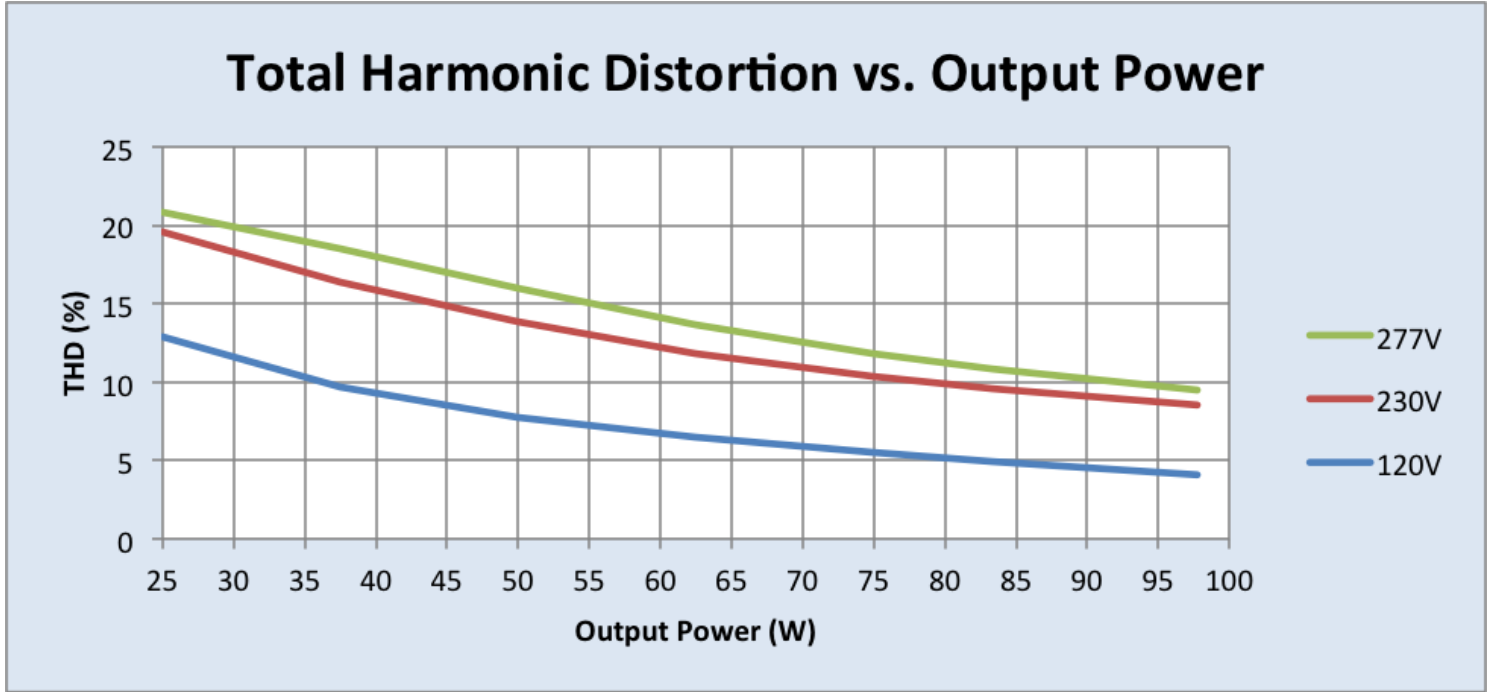

Output Current vs. Driver Case Temperature:

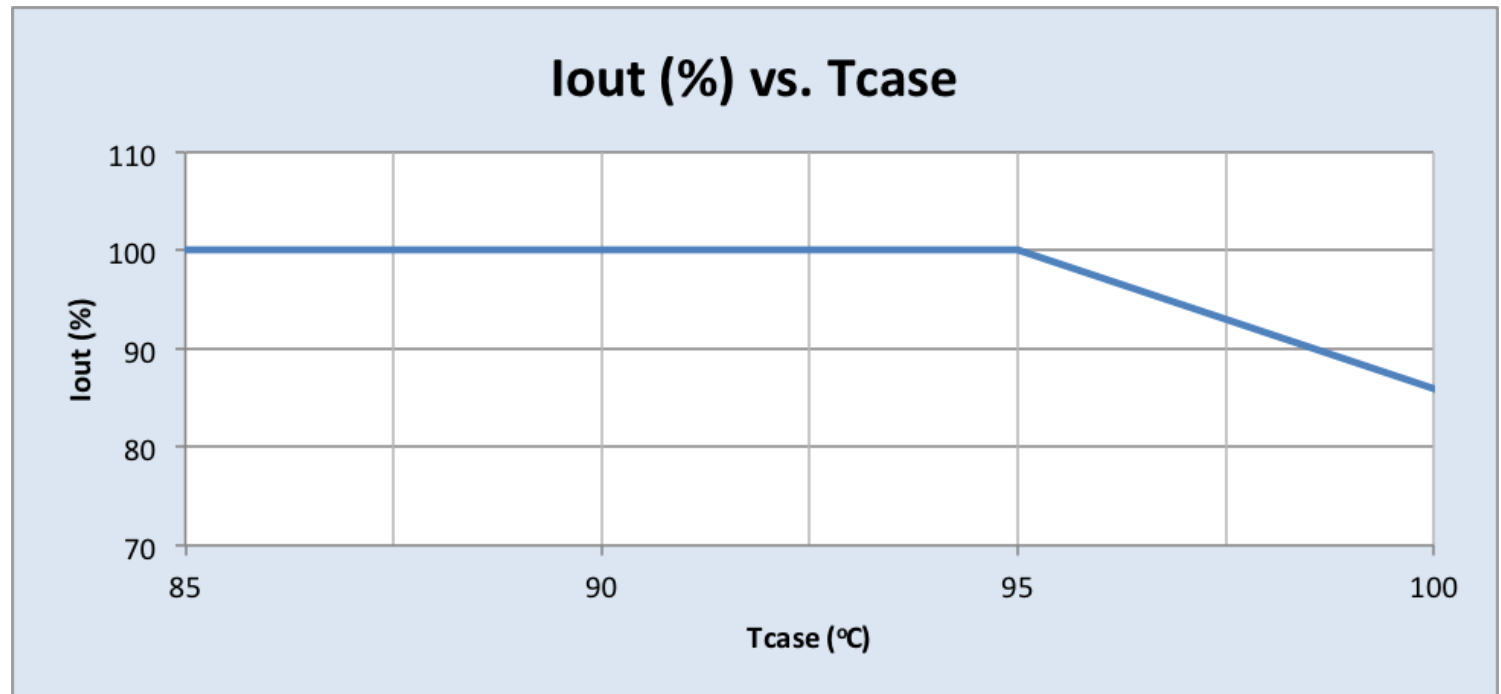

Xitanium 100W 120-277V 4.16A Fixed Output

Driver Lifetime vs. Driver Case Temperature:

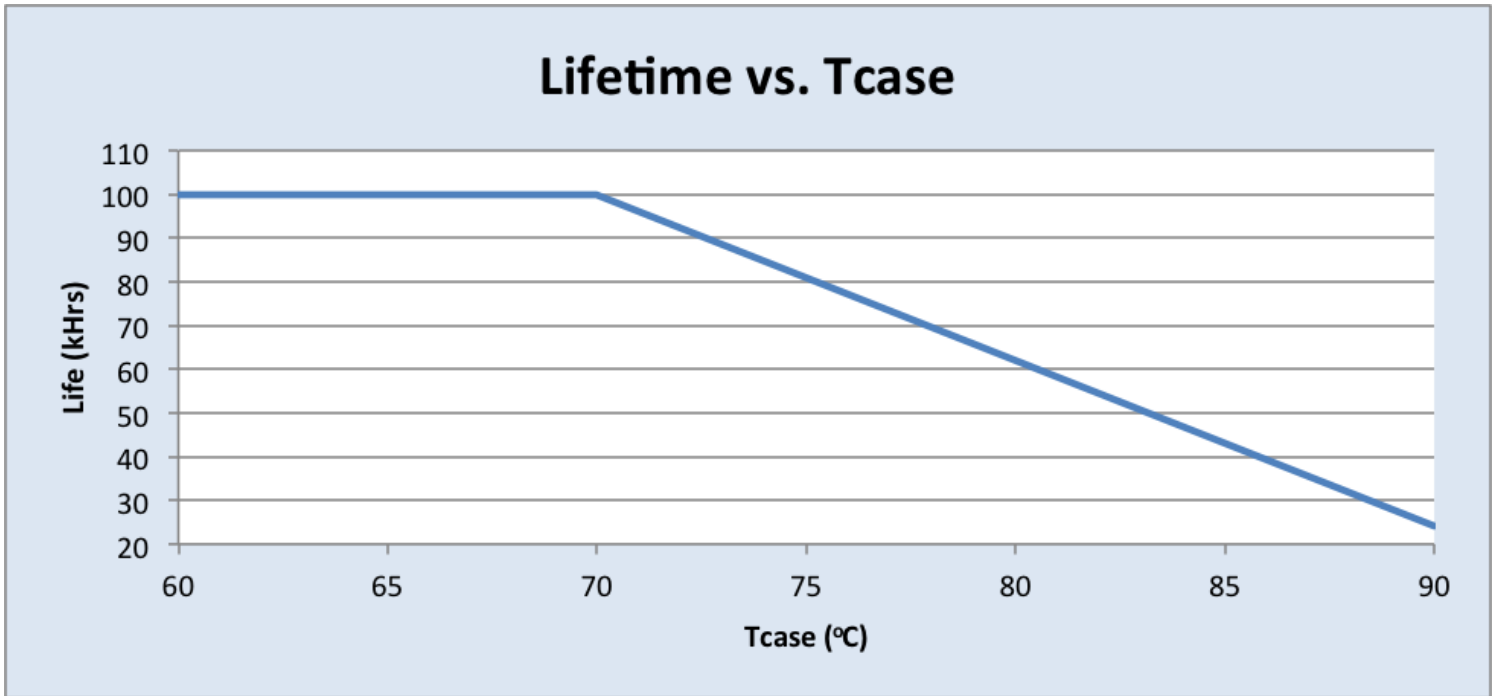

Xitanium 100W 120-277V 4.16A Fixed Output

Inrush Current Info:

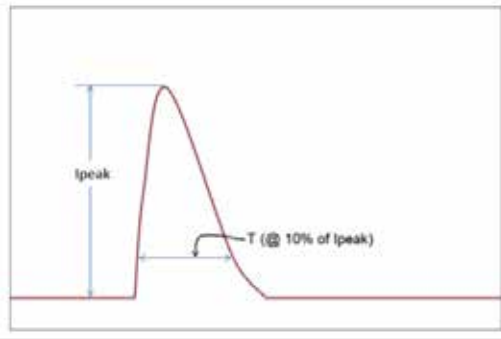

Vin	Ipeak	T (@ 10% of Ipeak)
120 Vrms	36A	228µs
277 Vrms	84A	216µs

Inrush current is measured at peak of the corresponding line voltage, source impedance per NEMA 410.

Lightning Surge Info:

ANSI Surge Type	Differential Mode (L-N)	Common Mode (L-G, N-G, L&N-G)
1.2/50µs Combination Wave (2Ω source impedance)	4kV	4kV

Isolation:

Isolation	Input	Output	Enclosure
Input	NA	2xU+1kV	2xU+1kV
Output	2xU+1kV	NA	2xU+1kV
Enclosure	2xU+1kV	2xU+1kV	NA



© 2014 Koninklijke Philips N.V. All rights reserved.
Philips reserves the right to make changes in specifications and/or to discontinue any product at any time without notice or obligation and will not be liable for any consequences resulting from the use of this publication.
philips.com/leddrivers



Philips Lighting North America Corporation
10275 W. Higgins Road, Rosemont IL 60018
Tel: 800-322-2086 Fax: 888-423-1882
Customer/Technical Service: 800-372-3331
OEM Support: 866-915-5886

Imported by: Philips Lighting
A division of Philips Electronics Ltd.
281 Hillmount Rd, Markham, ON, Canada L6C 2S3
Tel. 800-668-9008