



SIEMENS



Next Gen P1 Panelboards

Quick reference guide for selection and application

[siemens.ca/panelboards](https://www.siemens.ca/panelboards)

Introducing the Siemens Next Gen P1 Panelboard



Siemens is proud to introduce new, innovative additions to the P1 series of panelboards. The new “Next Gen P1” Panelboard increases the flexibility and customization options available in Siemens already robust panelboard line of products.

Siemens New “Next Gen P1” Panelboard

Siemens new Next Gen P1 panelboard adds additional strength and flexibility, through the introduction of Non-Feed-Thru options, to the already rugged, best-in-class line of panelboards. By now offering both Feed-Thru (FT) and Non-Feed-Thru (NFT) configuration options, Siemens offers even greater flexibility and potential for customers to configure solutions that are optimized to meet the many unique application and budgetary requirements that today’s projects demand.

For applications where additional space for feed-thru lugs, a subfeed breaker, or an SPD device isn’t required, the new NFT P1 option is an ideal solution. The NFT Next Gen P1 features an enclosure that is 6” (152 mm) shorter than a comparably configured P1 with a FT design. Additionally, the NFT design can accommodate 12 circuits more than the FT design panelboard in the same sized enclosure.

Extended Circuitries

In addition to the new NFT options, Siemens P1 line of panelboard products now offer extended circuit options. New, higher 54 and 66 circuit options allow for the elimination

of a second enclosure in many applications that would have previously required it.

The extended circuit options also facilitate the configuration of P1 panelboard solutions for many applications that have traditionally required the use of a P2 or P3 panelboard.

Adaptability

The new NFT design, coupled with the extended circuitries offer additional options for adding circuits to existing Siemens P1 with the Feed-Thru design. Where a 42 circuit FT P1 panelboard needs additional circuits but is not utilizing the provided subfeed space, the interior can be replaced by a new 54 circuit NFT design interior. This saves the customer the cost of a new enclosure and cover while still providing the option for extended circuitries.

This selection and application guide is designed to provide full insight into these and many other new features, enhancements and options that will allow you to take full advantage of the flexibility and customization options Siemens offers to configure the P1 panelboard that best meets your specific needs.

Next Gen P1 Panelboard 250 & 400A

All FT and NFT are invertable in field – Top-feed or Bottom-feed

- Invertability
- Flexibility

FT

250A MLO / MB

400A MLO / MB

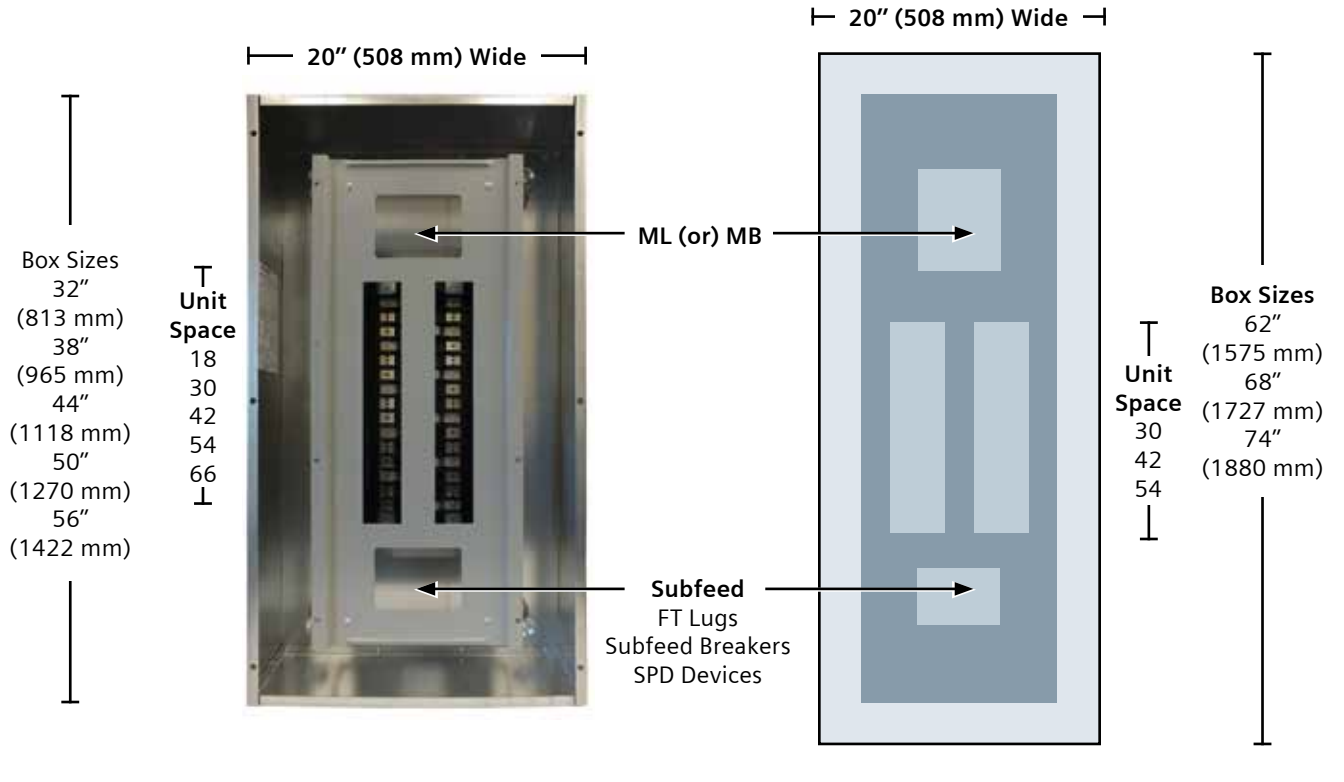

NFT

250A MLO / MB

400A MLO / MB

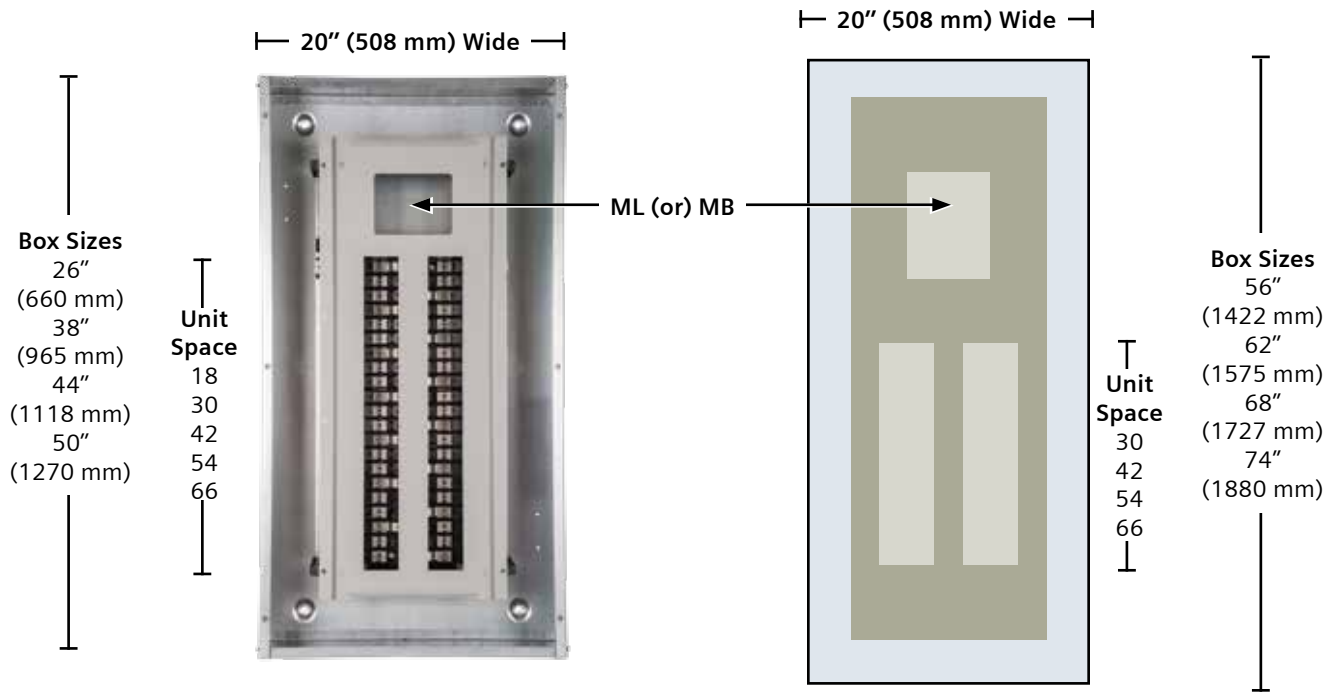

Next Gen P1 Panelboard 250A

Why move to NFT (Non Feed-Thru)?

A) Smaller Box Size -



If customer does not need Subfeed space or does not want to pay for it.

- 6" (152 mm) shorter enclosure than FT
- No Subfeed Space - pay for what is needed only.

B) More Circuits needed -

If customer does not need Subfeed space and does want more circuits.

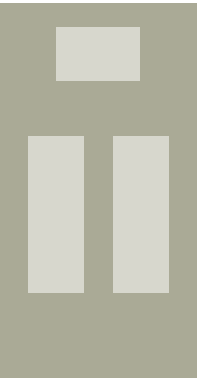
- 12 more circuits than FT in same box size

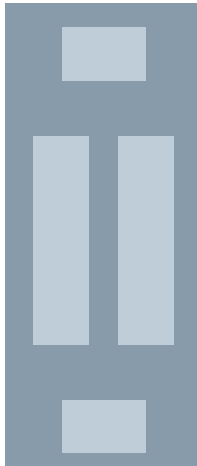
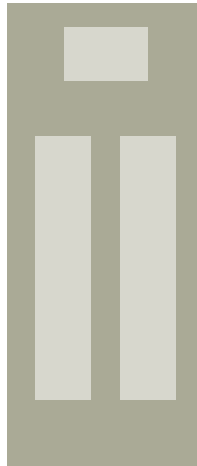
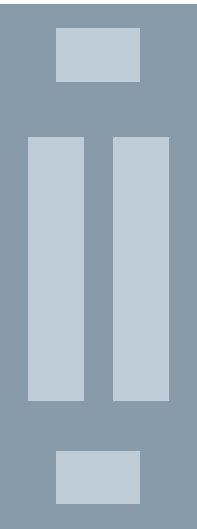
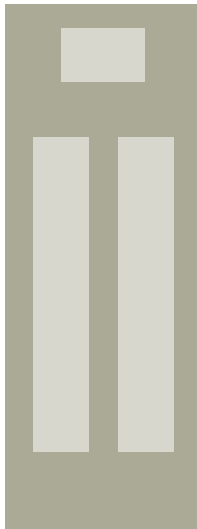
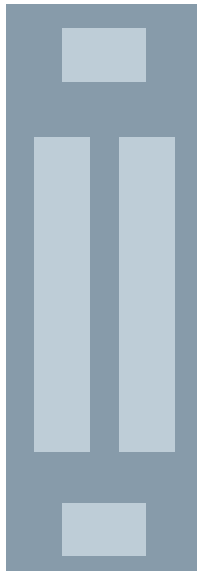
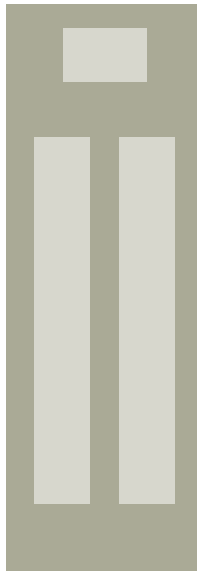
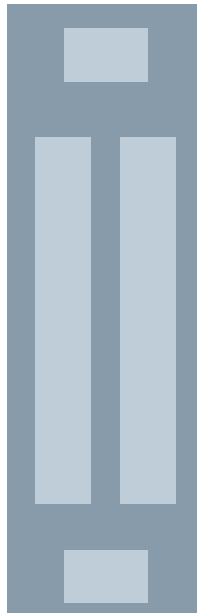
| | | | | |
|--|--|--|--|--|
| <p>New for Next Gen</p> <p>250A 18 circuit NFT</p>  <p>B26 Enclosure</p> <p>6" (152 mm) shorter than FT</p> | <p>Original & Next Gen</p> <p>250A 18 circuit FT</p>  <p>B32 Enclosure</p> | <p>New for Next Gen</p> <p>250A 30 circuit NFT</p>  <p>B32 Enclosure</p> <p>6" (152 mm) shorter than FT</p> | <p>Original & Next Gen</p> <p>250A 30 circuit FT</p>  <p>B38 Enclosure</p> | <p>New for Next Gen</p> <p>250A 42 circuit NFT</p>  <p>B38 Enclosure</p> <p>6" (152 mm) shorter than FT</p> |
| <p>Original & Next Gen</p> <p>250A 42 circuit FT</p>  <p>B44 Enclosure</p> | <p>New for Next Gen</p> <p>250A 54 circuit NFT</p>  <p>B44 Enclosure</p> <p>6" (152 mm) shorter than FT</p> | <p>New for Next Gen</p> <p>250A 54 circuit FT</p>  <p>B50 Enclosure</p> | <p>New for Next Gen</p> <p>250A 66 circuit NFT</p>  <p>B50 Enclosure</p> <p>6" (152 mm) shorter than FT</p> | <p>New for Next Gen</p> <p>250A 66 circuit FT</p>  <p>B56 Enclosure</p> |

New Options to Consider!

- 1) If a customer has an existing 42 circuit FT installed and needs additional circuits, the interior can be replaced by a 54 circuit NFT. Re-use the same enclosure and front.
- 2) If a customer needs more than 42 circuits, you can use a 54 or 66 circuit device and eliminate the second cabinet.

Next Gen P1 Panelboard 400A

Why move to NFT (Non Feed-thru)?

A) Smaller Box Size -





If Customer does not need Subfeed space or does not want to pay for it.

- 6" (152 mm) shorter Enclosure than FT
- No Subfeed Space - pay for what is needed only.

B) More Circuits needed -

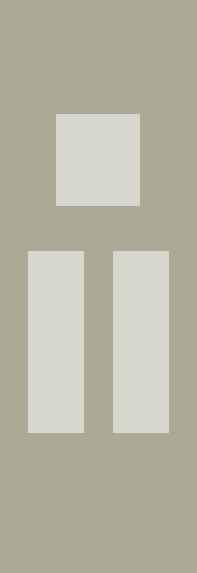
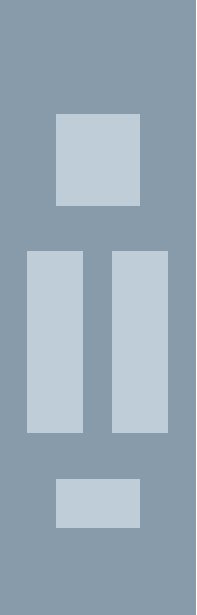
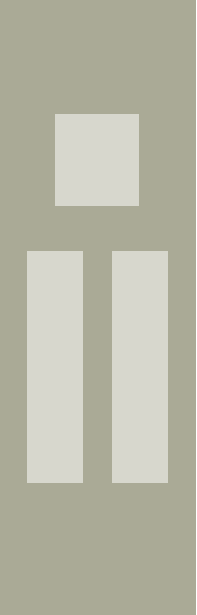
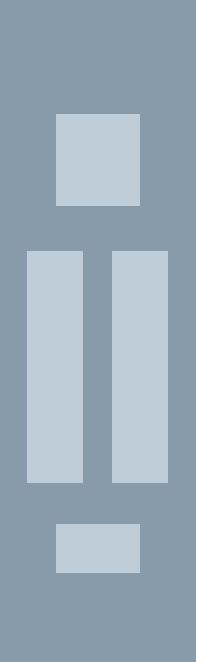
If Customer does not need Subfeed space and does want more circuits.

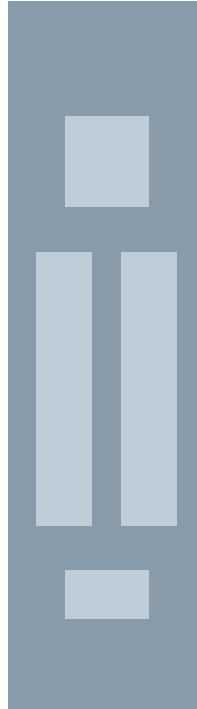
- 12 more circuits than FT in same box size

| | | | | |
|---|--|---|--|--|
| <p>400A 18 circuit NFT</p> <p>No Longer Available</p>  | <p>New for Next Gen</p> <p>400A 30 circuit NFT</p>  <p>B56 Enclosure</p> <p>6" (152 mm) shorter than FT</p> | <p>Original & Next Gen</p> <p>400A 30 circuit FT</p>  <p>B62 Enclosure</p> | <p>New for Next Gen</p> <p>400A 42 circuit NFT</p>  <p>B62 Enclosure</p> <p>6" (152 mm) shorter than FT</p> | <p>Original & Next Gen</p> <p>400A 42 circuit FT</p>  <p>B68 Enclosure</p> |
| <p>New for Next Gen</p> <p>400A 54 circuit NFT</p>  <p>B68 Enclosure</p> <p>6" (152 mm) shorter than FT</p> | <p>New for Next Gen</p> <p>400A 54 circuit FT</p>  <p>B74 Enclosure</p> | <p>New for Next Gen</p> <p>400A 66 circuit NFT</p>  <p>B74 Enclosure</p> | <p>400A 66 circuit FT</p> <p>Not Available</p> | <p>New Options to Consider!</p> <ol style="list-style-type: none"> 1) If a customer has an existing 42 circuit FT installed and needs additional circuits, the interior can be replaced by a 54 circuit NFT. Re-use the same enclosure and front. 2) If a customer needs more than 42 circuits, you can use a 54 or 66 circuit device and eliminate the second cabinet. |

Next Gen P1 Panelboard FAQ's

New Features and Options for "Next Gen P1" offering compared to the "Original P1" panels

1. Non-Feed-thru (NFT) variations of the Next Gen P1 panels are available for Factory assembled only:

- Feed-Thru (FT) versions are versions with a Subfeed space that can be occupied by Feed-thru lugs, Subfeed Breaker or an SPD device. All Original P1 interiors were FT versions.
- Non-Feed-thru (NFT) versions do not have the Subfeed space and therefore can fit into an enclosure 6" (152 mm) smaller than the FT version.
- Both FT and NFT variations are fully invertible in the field and can be used for either Top-feed or Bottom-feed applications.

2. Extended Circuits are now available:

Only 18, 30 and 42 circuits were available in Original P1 → 54 and 66 "extended circuit" panels are added for Next Gen P1

- a) Next Gen P1 - 250A will have FT and NFT variations for all circuits: 18, 30, 42, 54 and 66 (NGB panels only available as FT)
- b) Next Gen P1 - 400A will have FT and NFT variations for 30, 42, 54 circuits only. (NGB panels only available as FT)
 - The 66 circuit variation of 400A is only available in NFT due to enclosure size limit of 74" high.
 - Also Next Gen P1 - 400A is not available in 18 circuit variations.

→ Benefits: Many P2 and P3 applications can now move to the Next Gen P1 platform!

3. New Neutral Configurations are now available in Next Gen P1:

- The new Neutral system has been developed to accommodate the extended circuit variations without increasing costs.
- The New Neutral configuration is still a split neutral arrangement with connections down either side of the interior, but it is not full length as before. Neutral connections are still near the breakers, but not adjacent to each breaker connection. Many configurations have extra connections and some larger configurations will allow adding more connections if needed.

4. Into stock program changes for Next Gen P1:

- Into stock program will only get 54 circuit added for both P1-250A and P1-400A.
- All into stock interiors will be the FT variation, the same as Original P1. (400A - 18 circuit is no longer available)
- All old Accessories/Kits will remain available for future needs in Original P1 installations.
- New Accessories/Kits are available - most are same as old kits with "A" added to end of part number.

5. Accessories and Kits for Next Gen P1 are replacing most of the Original P1 Kits:

(most simply add an "A" to end of old kit number)

- a) All Main/Subfeed Breaker mounting kits are new for the Next Gen P1.
- b) All Main Lug Kits are new for Next Gen P1.
- c) All Neutral Lug Kits are new for Next Gen P1.

6. BL/BQD and NGB Main Breaker usage is ONLY available as a Back-Fed variation.

- The Next Gen P1 interior does not have "strap kits" for the BL/BQD and NGB breakers to be used in the "Main" or "Subfeed" positions. If needed to be used as a Main - we now have a "Main Label Kit" that allows the placement of the breaker in unit space to be used as the Main when labeled properly. This does reduce unit space by "2 circuits" in a single phase panel and by "3 circuits" in a 3-phase panel. In other words, the first 2 circuits (single phase panel) or 3 circuits (3-phase panel) on the top left of the interior will be used for the main breaker by default.
- Back-fed variations can not be used for service entrance application.

7. New B-Phase bus configuration eliminates "Hump-bus" design

- The new flat bus with "B-Phase" connector has many benefits. Allows for replacement connectors in the field in case of a "stripped" connection.
- Accessory kits for both CU and AL variations of the B-Phase connectors and A/C connectors will be available for repair purposes only.

8. NGB Breaker series introduction:

- This addition to the Breaker line will now allow many configurations to use the Next Gen P1 series. See rating below:
NGB – 14,000 A IR Max. @ 600Y/347V AC / 100,000 A IR @ 240V AC

9. Misc. additional features:

- a) New 750 kcmil AL Main Lug will be available as an option for 400A. (CU cable limited to 600 kcmil)
- b) New 2/0 neutral kits are available. (Standard with NGB interiors)
- c) New filler DFFP1 is introduced replacing QF3-UL (fits tighter in deadfront)

10. Misc. additional changes/notes:

- a) All DC voltage offerings are removed from scope of Next Gen P1 interiors.

→ Customers will be moved to a P2 configuration for these DC Voltage applications.

- b) The Next Gen P1 with NGB is limited to:
 - 100A per connection (200A per pair) for 18 circuit 250A construction.
 - 125A per connection (250A per pair) for 30, 42, 54 and 66 circuit 250A and 400A construction.

11. In the Next Gen P1, the branch breaker screws will be supplied as a kit with the interior

Index

Next Gen P1 panelboards quick reference guide for selection and application

| Description | Page |
|--------------------------------------|------|
| Introduction..... | ii |
| Next Gen P1 Panelboard Overview..... | iii |
| Next Gen P1 Panelboard FAQs..... | vi |

Next Gen P1 Factory Assembled Panelboards

| | |
|---|-----------|
| General Information | 2 |
| Selection and Application..... | 2 |
| General Specifications | 3 |
| Catalogue Numbering System – (Factory Assembled) | 4 |
| Application | 5 |
| Main Breaker Panel Size Selector – Next Gen P1..... | 5 |
| Main Breaker Selection..... | 5 |
| Main Lug Panel Size Selector – Next Gen P1..... | 6 |
| Branch Circuit Breakers..... | 6 |
| Subfeed Breakers..... | 7 |
| Breaker Mounting Kit..... | 7 |
| Lug Kits (Main or Feed-Thru)..... | 7 |
| Copper Neutral Lug Kits – 250A..... | 7 |
| 2/0 Neutral Lug Kits – 250A and 400A..... | 7 |
| 200% Neutral Lug Kits – 250A..... | 7 |
| 200% Neutral Lug Kits – 400A..... | 7 |
| Main Breaker Gutter Dimensions..... | 8 |
| Main Lug End Gutter Dimensions..... | 8 |
| Side Gutter Wiring Space..... | 8 |
| Typical Catalogue Numbers | 9 |
| Main Lugs Only..... | 9 |
| Main Circuit Breaker..... | 9 |
| Standard Enclosures..... | 9 |
| Standard Modifications | 10 |
| Miscellaneous Modifications | 11 |
| Compression Lugs..... | 11 |
| Enclosure Modifications..... | 11 |
| Remote Switch Modifications..... | 11 |
| Dimensions | 12 |

Next Gen P1 Into Stock Panelboards

| | |
|---|-----------|
| New Next Gen P1 into stock | 14 |
| Catalogue Numbering System (Into Stock) | 15 |
| Distributor Stock | 16 |
| Type P1 into stock (Next Gen P1 Introduced June 2015)..... | 16 |
| Lug Kits – Main or Feed Thru..... | 17 |
| Breaker Mounting Kits..... | 17 |
| Copper Neutral Lug Kits – 250A..... | 17 |
| 2/0 Neutral Lug Kits – 250A and 400A..... | 17 |
| 200% Neutral Lug Kits – 250A..... | 17 |
| 200% Neutral Lug Kits – 400A..... | 17 |
| Miscellaneous Parts and Accessories..... | 17 |
| Main Breaker Mounting Kits with Breakers..... | 18 |
| AFCI and GFCI breakers..... | 18 |
| Branch Breakers Selection for P1..... | 19 |
| BL Branch Breakers – 10,000A IR..... | 19 |
| HBL Branch Breakers – 65,000A IR..... | 19 |
| GFCI Personnel Protection (5MA)..... | 19 |
| BLH Branch Breakers – 22,000A IR..... | 19 |
| BQD Branch Breakers – 14,000A IR..... | 19 |
| NGB Family Branch Breakers..... | 19 |
| TPS Surge Protection Devices | 20 |

Type P1 Panelboards

The Next Gen P1 Panelboards are now available in both Feed-thru (FT) and Non-Feed-thru (NFT) variations. There is a saving of 6" (152 mm) of box height when a NFT version is selected which eliminates the subfeed space. The subfeed Space is where the Feed-thru Lugs, subfeed breaker or a Surge Protection Device (SPD) is installed. The interior part number will end with a "T" for FT panels and will end with an "N" for NFT panels.

The Next Gen P1 Panelboards also have Extended Circuit variations with 54 circuits and 66 circuits available.

Feed-thru (FT) panels are pre-engineered to accept the most common modifications without increasing box height. The enclosure size is determined by the number of circuits as shown in the Main Lug Table P1-5 or the Main Circuit Breaker Table P1-3.

All Next Gen P1 FT main lug or main breaker panelboards have space built-in to accept either feed-thru lugs equal to the panel rating (or) one subfeed circuit breaker up to 250 amperes (or) a surge protection device (SPD) without increasing box height. **(When ordered with subfeed space the interior part # will end with a "T").**

Non-Feed-thru (NFT) panels do not have a subfeed space and cannot accept feed-thru lugs (or) subfeed Breakers (or) SPD devices. **(NFT panel interior part # will end with a "N").**

Note the following features, all found in the Next Gen P1 lighting panelboards:

- Symmetrical 250A FT Interiors – To change from top to bottom-feed (or vice-versa), simply invert the interior. The deadfront labeling is always legible, even on the NFT panels when inverted. 400A are not symmetrical, but they are invertable.
- First in the Industry Ratings of 125 through 400A main lug and main breaker. Field convertible from main lug to main breaker and vice versa – with no increase in enclosure height.
- Field adaptability of feed-thru lugs (or) subfeed circuit breaker without increasing enclosure size. **(FT panels only)**
- Neutral system is field upgradeable to 200% capacity – another industry first. (also 2/0 neutrals are available as a field install kit)
- Extended circuit panels are now available – up to 66 circuits.
 - 18, 30, 42, 54 and 66 circuits for 250A **(FT & NFT)**
 - 26", 32", 38" 44", 50" and 56" (660 mm, 813 mm, 965 mm, 1118 mm, 1270 mm, 1422 mm) standard enclosures are used.
 - 30, 42 and 54 circuits for 400A (FT & NFT), also 66 circuit NFT
 - 56", 62", 68" and 74" (1422 mm, 1575 mm, 1727 mm, 1880 mm) standard enclosures are used.

- Suitable for use as service entrance given compliance with CEC:
 - Service Entrance equipment rating is not available for panels using BQD, BL, BLH, HBL and NGB as main breakers types.
 - 200% neutral are not available for panel rated as service entrance equipment.
- Bonding provisions (BK1A) provisions are shipped with each panel.
- 240V and 600V versions utilize identical boxes & fronts

Enclosure – Standard Type 1 enclosure is 20" wide x 5.75" deep (508mm W x 146mm D). Box Height is determined only by the number of circuits and FT or NFT selection, not by main lug or main circuit breaker. See tables P1-3 and P1-5 for box height.

Voltage – 600Y/347 Vac max.

Amperage – 400 amp max.

Short Circuit Rating

- 200 KAIC max. symmetrical @ 240V
 - 100 KAIC max. symmetrical @ 600V
- or equal to the lowest rated device installed unless a series rating is indicated. Note that the main device may be mounted remote from the panel.

Bussing – The P1 panel meets the majority of the markets bussing requirements. The standard bussing is aluminum. The rating is per the requirements of C22.2 No.29, the standard for panelboards. All aluminum bussing is tin-plated. Optional bussing for the P1 panel is copper. The copper bus option for this panel is tin-plated.

Weight – Approximate

Total panelboard weight when filled with a normal quantity of breakers and accessories is about 3 lbs. (1.36 kg) per inch (54g per mm) of box height.

Table P1-1 – Box Material Gauge

| Width in inches (mm) | | Height in inches (mm) | Gauge Steel |
|----------------------|--------|--|-------------|
| 20 (508) | (250A) | 26, 32, 38, 44, 50, 56 (660, 813, 965, 1118, 1270, 1422) | #14 |
| | (400A) | 56, 62, 68, 74 (1422, 1575, 1727, 1880) | #14 |

Table P1-2 – Trim Material Gauge

| | | | |
|----------|--------|--|-----|
| 20 (508) | (250A) | 26, 32, 38, 44, 50, 56 (660, 813, 965, 1118, 1270, 1422) | #14 |
| | (400A) | 56, 62, 68, 74 (1422, 1575, 1727, 1880) | #14 |

Selection and Application

3 Easy Steps for Selecting a Siemens Next Gen P1 Panelboard (Note: Factory assembled panels are configurable in IQS)

Step 1

Determine voltage, system, amperage and interrupting rating of branch devices, plus modifications if any.

Example for standard lighting panelboard:

Amperage: 250A
 Voltage: 208Y/120V
 System: 3Ø4W
 Main: Main Lug
 Branches: 10K AIR, 42-20/1
 Modifications: None
 Feed Location: Top
 Sub-Feed req'd: Yes (as provision if wanted)
 Mounting: Surface

Step 2

Create a catalogue number by following the Panelboard Catalogue Numbering System

on page 4. The BL branch breakers were selected from the branch breaker selection table 1-6 on page 6.
 1-P1C42ML250ATST ("T" indicates FT version)
 42-20/1 BL

Note: If Subfeed space is not needed the NFT device can be used as below:
1-P1C42ML250ATN ("N" indicates NFT version) 42-20/1 BL

Step 3

Select enclosure size by the number of circuits and FT/NFT as shown in the panelboard dimension chart (Table P1-3) on page 5.
 1-P1C42ML250ATSN
 42-20 BL
 Box size – 44" high

A unique feature of P1 FT panels is that they can accommodate either feed-thru lugs or one subfeed circuit breaker (up to 250A) without any addition to box height. For our example changing the branch circuits to 39-20/1 and 1-125/3, we have the following:
 1-P1C42ML250ATST
 39-20/1 BL
 1-125/3 QJ2
 Box size – 44" high
 The QJ2 subfeed was selected from Table P1-7 of subfeed breakers on page 7.
 The box height remains the same.

General Specifications

Service Entrance Equipment

When a panelboard is used as service entrance equipment, it must be located as close as practicable to the point of entrance of building supply conductors. Panelboards must be identified as "Service Entrance" at the time of order entry in order to be supplied with the appropriate CSA certification and labelling. Panels include a connector for bonding and grounding neutral conductor. Please consult CSA, CEC and local inspection authorities for specification and installation guidelines.

Service Entrance equipment rating is not available for panels using BQD, BL, BLH, HBL and NGB as main breakers types.

200% neutral is not available when service entrance equipment rating is required. Panelboards with service entrance rating are available as Factory Assembled only.

Integrated Equipment Short Circuit Rating

The term "Integrated Equipment Short Circuit Rating" refers to the application of series connected circuit breakers in a combination that allows some breakers to have lower individual interrupting ratings than the available fault current. This is permitted as long as the series combination has been tested and certified by CSA. "Series Rated" must be identified at the time of order entry.

For more information consult the series combinations catalogue.

Standards

CSA: C22.2 No.29. Certified under files #1267408

UL: 67, 50 and 50E. Listed by Underwriter's Laboratories, Inc., under "Panelboards" File #E2269, and #E4016.

Wire Connectors

Standard wire connectors in Siemens panels are suitable for copper or aluminum cables rated 60/75 degree Celcius. Copper main lugs are a price-added option for most panel types and some Circuit Breakers (check with Siemens sales for availability). It should be noted that most copper lugs will only accept copper cables. Some applications, 100% rated devices in particular, require that the cable and connectors be rated 90 degree Celcius but are sized to the 75 degree Celcius tables.

Standard ground connectors are also suitable for copper or aluminum wire. Ground connector assemblies (EGK, IGK) have (6) 1/0 max. and (15) #6 max. connections. The 1/0 holes are capable of connecting up (3) #10 max. wires. The #6 holes can accept up to (2) #12 max. wires. Copper ground assemblies (ECGK, ICGK) are rated for copper wire only and have the same wiring capacity as the AL/CU connectors.

Standard neutrals, like standard main lugs, are also rated for copper or aluminum wire. The neutral cross bar material follows the selection bus. Copper neutral lugs are rated for copper cable only and available as a price added option.

Feed Thru Lugs

Fig G-1

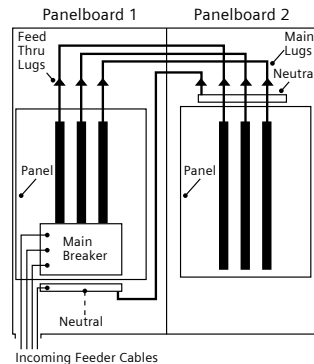

Subfeed lugs or double lugs

Fig G-2 (Not available for P1 panels)

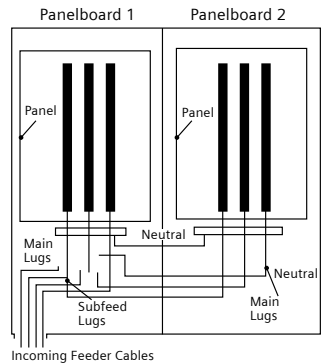

Feed-thru lugs are mounted at the opposite end of the main bus from the main lugs or main breaker and are used to connect two or more panelboards to the incoming feeder. The feeder cables are brought into Panelboard 1 and connected to the main lugs or main breaker. Cables interconnecting the two panelboards are connected to the feed-thru lugs in Panelboard 1 and are carried over the main lugs in Panelboard 2. This arrangement could be reversed with the main lugs located at the top and the feed-thru lugs at the bottom of the panel.

Subfeed lugs are mounted directly beside the main incoming lugs and are used to connect two or more panelboards to the incoming feeder. The feeder cables are brought into Panelboard 1 and connected to the main lugs. Another set of cables that are the same size are connected to the subfeed lugs of Panelboard 1 and are carried over the main lugs of Panelboard 2.

Note: P1 panelboards do not have Subfeed lugs available. If this configuration is needed, move to a P2 or P3 panelboard.

Catalogue Numbering System

Next Gen P1 Factory Assembled Panelboards

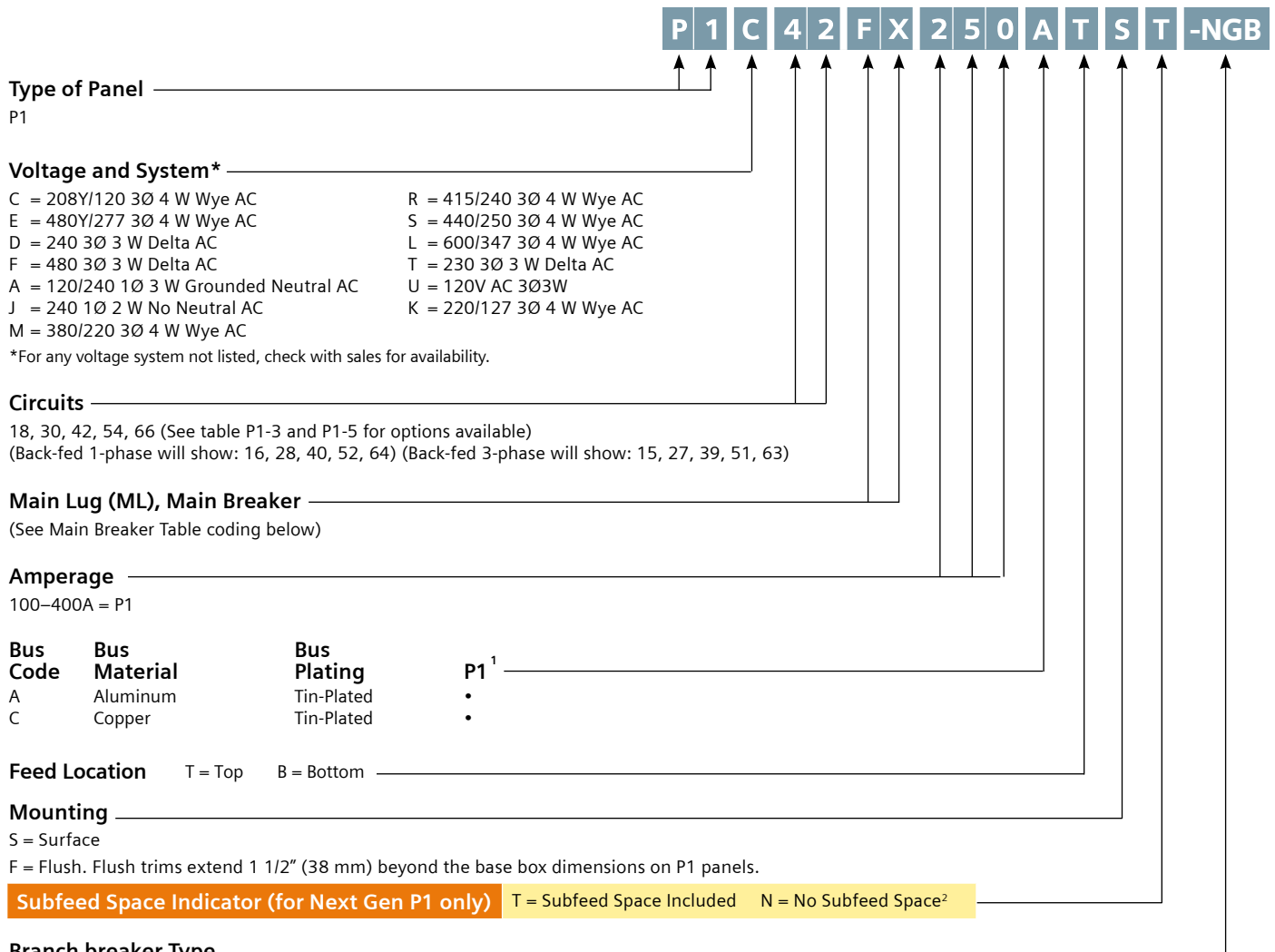

Branch breaker Type

NONE = BL/BQD type

- NGB = NGB type only

Main Breaker Coding

| Code | Breaker Type | Code | Breaker Type | Code | Breaker Type | Code | Breaker Type | Code | Breaker Type |
|------|--------------|------|--------------|------|--------------|------|--------------|------|--------------|
| BL | BL | HB | HBL | J6 | JD6 | QJ | QJ2 | SX | SHJD6 |
| BH | BLH | H4 | HED4 | JD | JXD2 | Q2 | QJ2H | SY | SHJD6H |
| BR | BLR | HF | HFD6 | JX | JXD6 | QH | QJH2 | SJ | SJD6 |
| BQ | BQD | H2 | HFXD6 | JH | JXD6H | | | SH | SJD6H |
| B6 | BQD6 | H6 | HJD6 | L6 | LD6 | | | S1 | SCLD6 |
| E4 | ED4 | H5 | HJXD6 | LX | LXD6 | | | S2 | SHLD6 |
| E6 | ED6 | HL | HLD6 | LH | LXD6H | | | SL | SLD6 |
| FD | FD6 | HO | HLXD6 | NB | NGB | | | | |
| FX | FXD6 | HP | HLXD6H | | | | | | |

1 Standard bussing in P1 panels is tin-plated for aluminum and copper. Standard bus is rated to the maximum amperage in the panel.

2 Not available for Next Gen P1 NGB interiors.

Application

Type P1 Panelboards

Table P1-3 – Main Breaker Panel Size Selector – Next Gen P1

| Max Ampere rating | Main Breaker Types | Connections suitable for Al or Cu | Max # Poles FT ¹ | Max # Poles NFT | Dimensions in inches (mm) | | | Weight in Lbs. (kg) |
|-------------------|--|---|-----------------------------|-----------------|---------------------------|----------|--------------|---------------------|
| | | | | | Unit Space FT A | NFT A | Box Height B | |
| 70 | BQD6 ² | BL: 40-50A: #8-#4 AWG Al or #8-#6 AWG Cu | – | 18 | – | 9 | 26 (661) | 90 (41) |
| 100 | BL ² , BLH ² , HBL ² , BQD ² | 55-70A: #8-#2 AWG Al or #8-#4 AWG Cu | 18 | 30 | 9 | 15 | 32 (813) | 105 (48) |
| | | 80-100A: #2-#1/0 AWG Al or #4-#1/0 AWG Cu | 30 | 42 | 15 | 21 | 38 (965) | 120 (55) |
| | | BQD: 45-100A: #6-1/0 AWG Al #8-#1 AWG Cu | 42 | 54 | 21 | 27 | 44 (1118) | 135 (61) |
| | | | 54 | 66 | 27 | 33 | 50 (1270) | 150 (67) |
| | | | 66 | – | 33 | – | 56 (1423) | 165 (73) |
| 125 | NGB 2 ED2, ED4 ED6, HED4 | NGB: 35-125A: #4-2/0 AWG Al or #6-1/0 AWG Cu | – | 18 | – | 9 | 26 (661) | 95 (43) |
| | | ED: 30-100A: #10-1/0 AWG Al/Cu 110-125A: #1-2/0 AWG Al or #3-3/0 AWG Cu | 18 | 30 | 9 | 15 | 32 (813) | 110 (50) |
| | | | 30 | 42 | 15 | 21 | 38 (965) | 125 (57) |
| | | | 42 | 54 | 21 | 27 | 44 (1118) | 140 (64) |
| | | | 54 | 66 | 27 | 33 | 50 (1270) | 155 (71) |
| | 66 | – | 33 | – | 56 (1423) | 170 (78) | | |
| 225 | QJ2, QJH2, QJ2-H | #4 AWG-300 Kcmil (Al) or #6 AWG-300 Kcmil (Cu) | – | 18 | – | 9 | 26 (661) | 95 (43) |
| | | | 18 | 30 | 9 | 15 | 32 (813) | 110 (50) |
| | | | 30 | 42 | 15 | 21 | 38 (965) | 125 (57) |
| 250 | FXD6, FD6, HFD6, HFXD6 | #4 AWG-350 Kcmil (Al) or #6 AWG-350 Kcmil (Cu) | 42 | 54 | 21 | 27 | 44 (1118) | 140 (64) |
| | | | 54 | 66 | 27 | 33 | 50 (1270) | 155 (71) |
| | | | 66 | – | 33 | – | 56 (1423) | 170 (78) |
| 400 | JD6, JXD6, HJD6, HJXD6 | 4/0-500 Kcmil (Al) or 3/0-500 Kcmil (Cu) | – | 30 | – | 15 | 56 (1423) | 172 (78) |
| | | | 30 | 42 | 15 | 21 | 62 (1575) | 190 (86) |
| | | | 42 | 54 | 21 | 27 | 68 (1728) | 208 (95) |
| | | | 54 | 66 | 27 | 33 | 74 (1880) | 226 (104) |

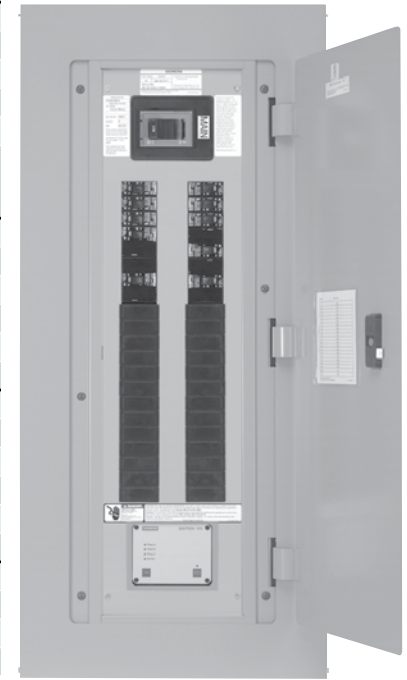

Note: Main breakers use breaker connectors. For sizes, see breaker connector chart on page 400A MLO panels have wire bend space for 600kcmil CU and AL wire when using the standard lug. With the optional 750kcmil AL/CU connector – wire bend space is available for up to 750kcmil AL, but is still limited to 600kcmil CU wire. 1 400A 66 circuit only available with non-feed thru versions.

2 BL, BLH, HBL, BQD, BQD6, and NGB main breakers are back fed mounted in unit space and count in max. # of poles.

Table P1-4 – Main Breaker Selection

| Ampere rating | Breaker Types | Max. Ir (kA) at | | Main Breaker Code | Additional Trip Values |
|---------------|-----------------------|-----------------|--------------|-------------------|---|
| | | 240V AC | 600Y/347V AC | | |
| 70 | BQD6 | 65 | 10 | B6 | 15, 20, 25, 30, 35, 40, 45, 50, 60, 70 |
| 100 | BL (STD) ⁴ | 10 | – | BL | 15, 20, 25, 30, 35, 40, 45, 50, 60, 70, 80, 90, 100 |
| | BLH ⁴ | 22 | – | BH | 15, 20, 25, 30, 35, 40, 45, 50, 60, 70, 80, 90, 100 |
| | HBL ⁴ | 65 | – | HB | 15, 20, 25, 30, 35, 40, 45, 50, 60, 70, 80, 90, 100 |
| | BQD ⁴ | 65 | – | BQ | 15, 20, 25, 30, 35, 40, 45, 50, 60, 70, 80, 90, 100 |
| 125 | NGB ⁴ | 100 | 14 | NB ³ | 15, 20, 25, 30, 35, 40, 50, 60, 70, 80, 90, 100, 125 |
| | ED4 | 65 | – | E4 | 15, 20, 25, 30, 35, 40, 50, 60, 70, 80, 90, 100, 125 |
| | HED4 | 42 | – | H4 | 15, 20, 25, 30, 35, 40, 50, 60, 70, 80, 90, 100, 125 |
| | ED6 (STD) | 65 | 18 | E6 | 15, 20, 25, 30, 35, 40, 45, 50, 60, 70, 80, 90, 100, 110, 125 |
| 225 | QJ2 (STD) | 10 | – | QJ | 60, 70, 80, 90, 100, 110, 125, 150, 175, 200, 225 |
| | QJH2 | 22 | – | QH | 60, 70, 80, 90, 100, 110, 125, 150, 175, 200, 225 |
| | QJ2-H | 42 | – | Q2 | 60, 70, 80, 90, 100, 110, 125, 150, 175, 200, 225 |
| 250 | FXD6 (STD) | 65 | 22 | FX | 70, 80, 90, 100, 110, 125, 150, 175, 200, 225, 250 |
| | FD6 | 65 | 22 | FD | 70, 80, 90, 100, 110, 125, 150, 175, 200, 225, 250 |
| | HFD6 | 100 | 25 | HF | 70, 80, 90, 100, 150, 175, 200, 225, 250 |
| | HFXD6 | 100 | – | H2 | 70, 80, 90, 100, 110, 125, 150, 175, 200, 225, 250 |
| 400 | JXD2 | 65 | – | JD | 300, 400 |
| | JXD6 (STD) | 65 | 25 | JX | 200, 225, 250, 300, 350, 400 |
| | JD6 | 65 | 25 | J6 | 200, 225, 250, 300, 350, 400 |
| | HJD6 | 100 | 35 | H6 | 200, 225, 250, 300, 350, 400 |
| | HJXD6 | 100 | 35 | H5 | 200, 225, 250, 300, 350, 400 |

³ NGB interiors are not available as non-feed-thru without subfeed space.

⁴ Service Entrance equipment rating are not available for panels using BQD, BL, BLH, HBL and NGB as main breaker types.

Application

Type P1 Panelboards

Table P1-5 - Main Lug Panel Size Selector - Next Gen P1

| Maximum Ampere rating | Max # Poles FT | Max # Poles NFT | Dimensions in inches (mm) | | | Weight in Lbs. (kg) | MLO Connectors Suitable for |
|-----------------------|----------------|-----------------|---------------------------|-------|---------------|---------------------|---|
| | | | Unit Space | | Box Height B" | | |
| | | | FT A | NFT A | | | |
| 125 (or) 250 | | 18 | – | 9 | 26 (661) | 90 (41) | (1) #6 AWG - 350 kcmil (CU or AL) |
| | 18 | 30 | 9 | 15 | 32 (813) | 105 (48) | |
| | 30 | 42 | 15 | 21 | 38 (965) | 120 (55) | |
| | 42 | 54 | 21 | 27 | 44 (1118) | 135 (61) | |
| | 54 | 66 | 27 | 33 | 50 (1270) | 150 (67) | |
| | 66 | – | 33 | – | 56 (1423) | 165 (73) | |
| 400 | – | 30 | – | 15 | 56 (1423) | 120 (55) | (2) 1/0 AWG to 250 kcmil AL or (1) #2 AWG to 600 kcmil AL or (1) 1/0-600 kcmil CU or (2) 1/0-4/0 CU |
| | 30 | 42 | 15 | 21 | 62 (1575) | 135 (61) | |
| | 42 | 54 | 21 | 27 | 68 (1728) | 150 (68) | |
| | 54 | 66 | 27 | 33 | 74 (1880) | 165 (75) | |

Table P1-6 – Branch Circuit Breakers

| Breaker Type | Number of Poles | Max. Interrupting Rating (kA) | | | | | Available Trip Values | Connections Suitable for Al or Cu |
|--------------------|-----------------|-------------------------------|----------|------|------|-----------|---|---|
| | | 120V | 120/240V | 240V | 347V | 600Y/347V | | |
| BL | 1 | 10 | – | – | – | – | 15, 20, 25, 30, 35, 40, 45, 50, 55, 60, 70 | 15-20A: #12-#10 AWG Al #14-#10 AWG Cu |
| | 2 | – | 10 | – | – | – | 15, 20, 25, 30, 35, 40, 50, 60, 70, 80, 90, 100 | |
| | 3 | – | – | 10 | – | – | 15, 20, 25, 30, 35, 40, 50, 60, 70, 80, 90, 100 | |
| BLH | 1 | – | 22 | – | – | – | 15, 20, 30, 40, 50, 55, 60, 70 | 25-35A: #8-#6 AWG Al/Cu 40-50A: #8-#4 AWG Al #8-#6 AWG Cu |
| | 2 | – | 22 | – | – | – | 15, 20, 30, 40, 50, 60, 70, 90, 100 | |
| | 3 | – | – | 22 | – | – | 15, 20, 30, 40, 50, 60, 70, 80, 90, 100 | |
| HBL | 1 | – | 65 | – | – | – | 15, 20, 30, 40, 50 | 55-70A: #8-#2 AWG Al #8-#4 AWG Cu |
| | 2 | – | 65 | – | – | – | 15, 20, 30, 40, 50, 60, 70 | |
| | 3 | – | – | 65 | – | – | 15, 20, 30, 40, 50, 60, 70, 80, 90, 100 | |
| BLF | 1 | 10 | – | – | – | – | 15, 20, 30 | 80-100A: #2-#1/0 AWG Al #4-#1/0 AWG Cu |
| | 2 | – | 10 | – | – | – | 15, 20, 30, 40, 50, 60 | |
| BLHF | 1 | 22 | – | – | – | – | 15, 20, 30 | |
| | 2 | – | 22 | – | – | – | 15, 20, 30, 40, 50, 60 | |
| BG ¹ | 2 | 10 | – | – | – | – | 15, 20, 30 | |
| | 3 | – | 10 | – | – | – | 15, 20, 30 | |
| BLE | 1 | 10 | – | – | – | – | 15, 20, 30 | |
| | 2 | – | 10 | – | – | – | 15, 20, 30, 40, 50, 60 | |
| BLEH | 1 | 22 | – | – | – | – | 15, 20, 30 | |
| | 2 | – | 22 | – | – | – | 15, 20, 30, 40, 50, 60 | |
| BAF2 | 1 | 10 | – | – | – | – | 15, 20 | |
| BAFH2 | 1 | 22 | – | – | – | – | 15, 20 | |
| HBAF2 | 1 | 65 | – | – | – | – | 15, 20 | |
| BQD | 1 | – | 65 | – | 14 | – | 15, 20, 25, 30, 35, 40, 50, 60, 70, 80, 90, 100 | 15-40A: #12-#6 AWG Al #14-#6 AWG Cu |
| | 2 | – | 65 | – | – | 14 | 15, 20, 25, 30, 35, 40, 50, 60, 70, 80, 90, 100 | |
| | 3 | – | – | 65 | – | 14 | 15, 20, 25, 30, 35, 40, 50, 60, 70, 80, 90, 100 | |
| BQD6 | 1 | 65 | – | – | 10 | – | 15, 20, 25, 30, 35, 40, 45, 50, 60, 70 | 45-100A: #6-#1/0 AWG Al #8-#1 AWG Cu |
| | 2 | – | – | 65 | – | 10 | 15, 20, 25, 30, 35, 40, 45, 50, 60, 70 | |
| | 3 | – | – | 65 | – | 10 | 15, 20, 25, 30, 35, 40, 45, 50, 60, 70 | |
| NGB ^{2,3} | 1 | 100 | – | – | 14 | – | 15, 20, 25, 30, 35, 40, 50, 60, 70, 80, 90, 100, 125 ³ | 15-30A: #12-#6 AWG Al #14-#6 AWG Cu 35-125A: #4-2/0 AWG Al #6-1/0 AWG Cu |
| | 2 | – | 100 | 100 | – | 14 | 15, 20, 25, 30, 35, 40, 50, 60, 70, 80, 90, 100, 125 ³ | |
| | 3 | – | 100 | 100 | – | 14 | 15, 20, 25, 30, 35, 40, 50, 60, 70, 80, 90, 100, 125 ³ | |

¹ Two-pole breaker is one phase and neutral. Three-pole is two phases and neutral.

² P1 panel with NGB branch devices will not accept BL or BQD frames in the same panel as branch devices.

³ The new Next Gen P1 (18 circuit 250A only) is limited to 100A per connection (200A per pair) when installing branch breakers across from one another. All other configurations allow 125A per connection max. (250A per pair max.)

NOTE: BL, HBL and BQD breakers are mounted in common mountings in 3" or (6) pole increments.

Application

Type P1 Panelboards

Table P1-7 – Subfeed Breakers

| Breaker Type | Number of Poles | Max. Interrupting Rating (kA) | | Available Trip Values |
|--------------|-----------------|-------------------------------|-----------|---|
| | | 240V | 600Y/347V | |
| QJ2 | 2, 3 | 10 | – | 60, 70, 80, 90, 100, 110, 125, 150, 175, 200, 225 |
| QJH2 | 2, 3 | 22 | – | 60, 70, 80, 90, 100, 110, 125, 150, 175, 200, 225 |
| QJ2H | 2, 3 | 42 | – | 60, 70, 80, 90, 100, 110, 125, 150, 175, 200, 225 |
| HQJ2 | 2, 3 | 100 | – | 60, 70, 80, 90, 100, 110, 125, 150, 175, 200, 225 |
| ED4 | 2, 3 | 65 | – | 15, 20, 25, 30, 35, 40, 45, 50, 55, 60, 70, 80, 90, 100, 110, 125 |
| ED6 | 2, 3 | 65 | 25 | 15, 20, 25, 30, 35, 40, 45, 50, 55, 60, 70, 80, 90, 100, 110, 125 |
| HED4 | 2, 3 | 100 | 22 | 15, 20, 25, 30, 35, 40, 45, 50, 55, 60, 70, 80, 90, 100, 110, 125 |
| FXD6 | 2, 3 | 65 | 25 | 70, 80, 90, 100, 110, 125, 150, 175, 200, 225, 250 |
| FD6 | 2, 3 | 65 | 25 | 70, 80, 90, 100, 110, 125, 150, 175, 200, 225, 250 |
| HFD6 | 2, 3 | 100 | 65 | 70, 80, 90, 100, 110, 125, 150, 175, 200, 225, 250 |
| HFXD6 | 2, 3 | 100 | 65 | 70, 80, 90, 100, 110, 125, 150, 175, 200, 225, 250 |

Table P1-8 – Breaker Mounting Kit
Main or Subfeed Strap Kit w/o Breaker

| Max Amp Rating | Breaker Frames | Service | Original P1 Catalogue Number | Next Gen P1 Catalogue Number |
|------------------|--------------------------|---------|------------------------------|---|
| 100A | BQD, BQD6 | 3 Phase | MBKBC3 | Use Back-fed Main Label Kit # MBKBFA ² (includes Neutral Lug, "MAIN" label and instructions) |
| 100A | BL, BLH, HBL | 1 Phase | MBKBL1 | |
| | | 3 Phase | MBKBL3 | |
| 125A | NGB | 1 Phase | – | |
| 125 | ED4, ED6, HED4 | 1 Phase | MBKED1 | MBKED1A |
| | | 3 Phase | MBKED3 | MBKED3A |
| 225 | QJ2, QJH2, QJ2-H | 1 Phase | MBKQJ1 | MBKQJ1A |
| | | 3 Phase | MBKQJ3 | MBKQJ3A |
| 250 | FXD6, FD6, HFD6, HFXD6 | 1 Phase | MBKFD1 | MBKFD1A |
| | | 3 Phase | MBKFD3 | MBKFD3A |
| 400 ¹ | JXD6, JD6 HJD6, HJXD6 | 1 Phase | MBKJD1 | MBKJD1A |
| | | 3 Phase | MBKJD3 | MBKJD3A |

¹ 400 amp kit is for main ONLY, not allowed for subfeed breaker.

² Back-fed main occupies branch space.

Table P1-9 – Lug Kits (Main or Feed-Thru)

| Max Amp Rating | Matl. | Wire Range (includes Neutral) | Service | Original Catalogue Number | Next Gen P1 Catalogue Number |
|----------------|-------|---|---------|---------------------------|------------------------------|
| 250 | AL | (1) #6 AWG-350 kcmil (CU or AL) | 1 Phase | MLKA1 | MLKA1A |
| | | | 3 Phase | MLKA3 | MLKA3A |
| | CU | (1) #6 AWG-350 kcmil (CU or AL) | 1 Phase | MLKC1 | MLKC1A |
| | | | 3 Phase | MLKC3 | MLKC3A |
| 400 | AL | (2) 1/0 - 250 kcmil or (1) #2 AWG-600 kcmil | 1 Phase | 4MLKA1 | 4MLKA1A |
| | | | 3 Phase | 4MLKA3 | 4MLKA3A |
| | CU | (1) 1/0-600 kcmil CU or (2) 1/0-4/0 CU | 1 Phase | 4MLKC1 | 4MLKC1A |
| | | | 3 Phase | 4MLKC3 | 4MLKC3A |
| 400 | AL | AL 1/0-750 kcmil (max. 600 kcmil CU wire) | 1 Phase | – | 4MLKA1B |
| | | | 3 Phase | – | 4MLKA3B |

Table P1-10 – Copper Neutral Lug Kits – 250A

| No. of Circuits | Description | Original P1 Catalogue Number | Next Gen P1 Catalogue Number |
|-----------------|--|------------------------------|------------------------------|
| 18 | 2 or 4 Branch Neutral Strips, 1 Main Neutral Lug, Hardware | CNLK18 | Use 30 ckt kit |
| 30 | | CNLK30 | CNLK30A |
| 42 | | CNLK42 | CNLK42A |
| 54, 66 | | – | CNLK54A |

Table P1-10A – 2/0 Neutral Lug Kits – 250A and 400A

| No. of Circuits | Description | Original P1 Catalogue Number | Next Gen P1 Catalogue Number |
|-----------------|--|------------------------------|------------------------------|
| 18 | 2 or 4 Branch Neutral Strips, Hardware | – | Use 30 ckt kit |
| 30 | | – | LNLK30A |
| 42 | | – | LNLK42A |
| 54, 66 | | – | LNLK54A |

Table P1-11 – 200% Neutral Lug Kits – 250A

| No. of Circuits | Description | Original P1 Catalogue Number | Next Gen P1 Catalogue Number |
|-----------------|---|------------------------------|------------------------------|
| 18 | 2 or 4 Branch Neutral Strips, 2 Main Neutral Lugs, Hardware | 2NLK18 | Use 30 ckt kit |
| 30 | | 2NLK30 | 2NLK30A |
| 42 | | 2NLK42 | 2NLK42A |
| 54, 66 | | – | 2NLK54A |

Table P1-12 – 200% Neutral Lug Kits – 400A

| No. of Circuits | Description | Original P1 Catalogue Number | Next Gen P1 Catalogue Number |
|-----------------|--|------------------------------|------------------------------|
| 18 | 2 or 4 Branch Neutral Strips, 1 Main 600 kcmil Neutral Lug, Hardware | 42NLK18 | N/A |
| 30 | | 42NLK30 | 42NLK30A |
| 42 | | 42NLK42 | 42NLK42A |
| 54, 66 | | – | 42NLK54A |

Application

Type P1 Panelboards

Table P1-13 – Main Breaker Gutter Dimensions Inches (mm)

| Main Breaker | Side Gutter | | Neutral Location |
|---------------------------|--------------|--------------|---------------------|
| | 20" wide box | 24" wide box | 20" or 24" wide box |
| BL, BLH, HBL ² | 8.500 (216) | 8.375 (213) | 10.500 (267) |
| BQD, BQD6 ² | 5.500 (140) | 7.500 (191) | 10.500 (267) |
| NGB ² | 8.000 (203) | 7.000 (191) | 10.500 (267) |
| ED2, ED4, ED6, HED4 | 6.125 (156) | 8.125 (206) | 10.500 (267) |
| QJ2, QJH2, QJ2-H | 6.500 (165) | 8.500 (216) | 10.500 (267) |
| FD6, FXD6, HFD6, HFXD6 | 5.250 (133) | 7.250 (184) | 10.500 (267) |
| JD6, JXD6 ¹ | 15.000 (381) | 15.000 (381) | 26.500 (674) |

¹JD Frame mounted vertically. Given dimensions are in respect to the End Gutter.

² These breakers are back-fed main breakers. Service Entrance equipment rating is not available for panels using back-fed main breakers.

Table P1-14 – Main Lug End Gutter Dimensions Inches (mm)

| Amp Rating | End Gutter | | Neutral Location | |
|------------|--------------|--------------|------------------|--------------|
| | 20" wide box | 24" wide box | 20" wide box | 24" wide box |
| 125 | 9.500 (242) | 9.500 (242) | 10.500 (267) | 10.500 (267) |
| 250 | 9.500 (242) | 9.500 (242) | 10.500 (267) | 10.500 (267) |
| 400 | 25.500 (648) | 25.500 (648) | 26.750 (680) | 26.750 (680) |

NOTE: Feed-thru lug and neutral wire bending space is 15.000" and 16.250" respectively on 400A panel.

Table P1-15 – Side Gutter Wiring Space Inches (mm) (Fig P1-1)

| Reference Letter | Panel Width 20" | Panel Width 24" Optional |
|------------------|-----------------|--------------------------|
| A | 6.375 (167) | 8.375 (213) |
| B | 5.500 (140) | 7.500 (191) |
| C | 5.000 (127) | 7.000 (178) |
| D | 6.125 (156) | 8.125 (206) |
| E | 6.500 (165) | 8.500 (216) |
| F | 5.250 (133) | 7.250 (184) |

Note: Subfeed mounting limit 1 per panel.

Fig P1-1

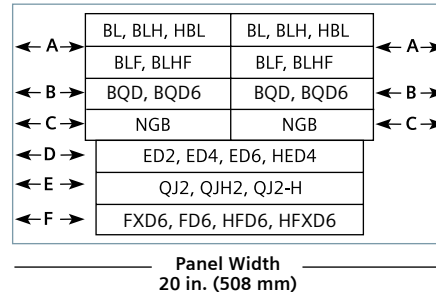

Miscellaneous Parts and Accessories

| Catalogue # | Description |
|--------------------------|---|
| BK1 | Bonding Kit for 250A max. Original P1 panels only |
| BK1A | Bonding Kit for 250A max. Next Gen P1 panels only |
| IMK1 | Interior Adjusting Kit |
| 11-1824-01 | Directory Card Holder |
| 12-1110-01 | Directory Card |
| 11-1056-01B | Instruction Book |
| NBK03 | Number Strips 1–42. Stick-on type; Use w/ P1 series Panels |
| NBK04 | Number Strips 43–84. Stick-on type; Use w/ P1 series Panels |
| NBK05 | Number Strips 85–126. Stick-on type; Use w/ P1 series Panels |
| NBK06 | Number Strips 127–168. Stick-on type; Use w/ P1 series Panels |
| EGK | AL Ground Bus 44 Connections |
| ECGK | CU Ground Bus 44 Connections |
| IGK | Insulated AL Ground Bus |
| ICGK | Insulated CU Ground Bus |
| P1SCRWS | Package of 42 breaker mounting screws for P1 |
| DFFP1 | 1" Branch circuit filler plate (suitable for replacing QF3-UL in panelboards (Package of 100 filler plates) |
| P1CONBPHCU [Ⓞ] | Connector kit – 6 pcs. B-phase Copper |
| P1CONBPHAL [Ⓞ] | Connector kit – 6 pcs. B-phase Aluminum |
| P1CONACPHCU [Ⓞ] | Connector kit – 6 pcs. A or C-phase Copper |
| P1CONACPHAL [Ⓞ] | Connector kit – 6 pcs. A or C-phase Aluminum |
| MCHK-1 | 1 Metallic directory card holder |
| FPLK2 | 2 Spare Fas-latch trim locks with 2 keys |
| SDKN | Dripshield kit (20" W x 5.75" D) |
| TPS9IKITP1 | Original P1 mounting bracket for SPD TPS3 09 |
| TPS9IKITP1A | Next Gen P1 mounting bracket for SPD TPS3 09 |
| MBKBFA | Back-Fed Main Breaker kit |

[Ⓞ] Replacement parts only.



Feed-Thru (FT)



Non-Feed-Thru (NFT)



Example of Back-fed NGB Main breaker installed

Typical Catalogue Numbers

Type P1 Factory Assembled Panelboards

Shown with Standard Mains, Top Fed and Surface Trim

Catalogue number is for aluminum main bus. For optional copper main bus change "A" in position 11 to "C".

Panels are top feed, surface mounted. For bottom feed, change "T" in position 12 to "B". For flush mounting, change "S" in position 13 to "F".

Replace fifth and sixth position in panelboard catalogue number, with alternate main breaker code.

Note: Original P1 was produced until 2015 and in June the Next Gen P1 was introduced. All interior numbers that end with "T" or "N" are the new Next Gen interiors. "T" at end of catalogue number indicates there is a Subfeed area available. "N" at end of catalogue number indicates there is no Subfeed area available.

Table P1-16 – Main Lugs Only

| Main Lug Only | | | Original P1 – Subfeed Space | Next Gen P1 – Subfeed Space ^{1,3} | Original P1 – Subfeed Space | Next Gen P1 – Subfeed Space ^{1,3} | Original P1 – Subfeed Space | Next Gen P1 – Subfeed Space ^{1,3,4} |
|----------------------|---------------------|------------------|--------------------------------------|--|-------------------------------------|--|--------------------------------------|--|
| Max Panel Amp Rating | Max 1-Pole Circuits | Box Height (in.) | 208Y/120V 3-Phase 4-Wire Catalogue # | 208Y/120V 3-Phase 4-Wire Catalogue # | 120/240V 1-Phase 3-Wire Catalogue # | 120/240V 1-Phase 3-Wire Catalogue # | 600Y/347V 3-Phase 4-Wire Catalogue # | 600Y/347V 3-Phase 4-Wire Catalogue # |
| 125 | 18 | 32 | P1C18ML125ATS | P1C18ML125ATST | P1A18ML125ATS | P1A18ML125ATST | P1L18ML125ATS | P1L18ML125ATST |
| | 30 | 38 | P1C30ML125ATS | P1C30ML125ATST | P1A30ML125ATS | P1A30ML125ATST | P1L30ML125ATS | P1L30ML125ATST |
| | 42 | 44 | P1C42ML125ATS | P1C42ML125ATST | P1A42ML125ATS | P1A42ML125ATST | P1L42ML125ATS | P1L42ML125ATST |
| | 54 | 50 | – | P1C54ML125ATST | – | P1A54ML125ATST | – | P1L54ML125ATST |
| | 66 | 56 | – | P1C66ML125ATST | – | P1A66ML125ATST | – | P1L66ML125ATST |
| 250 | 18 | 32 | P1C18ML250ATS | P1C18ML250ATST | P1A18ML250ATS | P1A18ML250ATST | P1L18ML250ATS | P1L18ML250ATST |
| | 30 | 38 | P1C30ML250ATS | P1C30ML250ATST | P1A30ML250ATS | P1A30ML250ATST | P1L30ML250ATS | P1L30ML250ATST |
| | 42 | 44 | P1C42ML250ATS | P1C42ML250ATST | P1A42ML250ATS | P1A42ML250ATST | P1L42ML250ATS | P1L42ML250ATST |
| | 54 | 50 | – | P1C54ML250ATST | – | P1A54ML250ATST | – | P1L54ML250ATST |
| | 66 | 56 | – | P1C66ML250ATST | – | P1A66ML250ATST | – | P1L66ML250ATST |
| 400 | 18 | 56 | P1C18ML400ATS | – | P1A18ML400ATS | – | P1L18ML400ATS | – |
| | 30 | 62 | P1C30ML400ATS | P1C30ML400ATST | P1A30ML400ATS | P1A30ML400ATST | P1L30ML400ATS | P1L30ML400ATST |
| | 42 | 68 | P1C42ML400ATS | P1C42ML400ATST | P1A42ML400ATS | P1A42ML400ATST | P1L42ML400ATS | P1L42ML400ATST |
| | 54 | 74 | – | P1C54ML400ATST | – | P1A54ML400ATST | – | P1L54ML400ATST |
| | 66 ² | 74 ² | – | P1C66ML400ATSN ² | – | P1A66ML400ATSN ² | – | P1L66ML400ATSN ² |

Table P1-17 – Main Circuit Breaker

| | | | | | | | | |
|------------------|-----------------|-----------------|---------------|-----------------------------|---------------|-----------------------------|---------------|-----------------------------|
| 100 | 18 | 32 | P1C18BL100ATS | P1C18BL100ATST | P1A18BL100ATS | P1A18BL100ATST | P1L18B6100ATS | P1L18B6100ATST |
| | 30 | 38 | P1C30BL100ATS | P1C30BL100ATST | P1A30BL100ATS | P1A30BL100ATST | P1L30B6100ATS | P1L30B6100ATST |
| | 42 | 44 | P1C42BL100ATS | P1C42BL100ATST | P1A42BL100ATS | P1A42BL100ATST | P1L42B6100ATS | P1L42B6100ATST |
| | 54 | 50 | – | P1C54BL100ATST | – | P1A54BL100ATST | – | P1L54B6100ATST |
| | 66 | 56 | – | P1C66BL100ATST | – | P1A66BL100ATST | – | P1L66B6100ATST |
| 125 ² | 18 | 32 | P1C18NB125ATS | P1C18NB125ATST | – | – | P1L18NB125ATS | P1L18NB125ATST |
| | 30 | 38 | P1C30NB125ATS | P1C30NB125ATST | – | – | P1L30NB125ATS | P1L30NB125ATST |
| | 42 | 44 | P1C42NB125ATS | P1C42NB125ATST | – | – | P1L42NB125ATS | P1L42NB125ATST |
| | 54 | 50 | – | P1C54NB125ATST | – | – | – | P1L54NB125ATST |
| | 66 | 56 | – | P1C66NB125ATST | – | – | – | P1L66NB125ATST |
| 225 | 18 | 32 | P1C18QJ225ATS | P1C18QJ225ATST | P1A18QJ225ATS | P1A18QJ225ATST | P1L18FX250ATS | P1L18FX225ATST |
| | 30 | 38 | P1C30QJ225ATS | P1C30QJ225ATST | P1A30QJ225ATS | P1A30QJ225ATST | P1L30FX250ATS | P1L30FX225ATST |
| | 42 | 44 | P1C42QJ225ATS | P1C42QJ225ATST | P1A42QJ225ATS | P1A42QJ225ATST | P1L42FX250ATS | P1L42FX225ATST |
| | 54 | 50 | – | P1C54QJ225ATST | – | P1A54QJ225ATST | – | P1L54FX225ATST |
| | 66 | 56 | – | P1C66QJ225ATST | – | P1A66QJ225ATST | – | P1L66FX225ATST |
| 250 | 18 | 32 | P1C18FX250ATS | P1C18FX250ATST | P1A18FX250ATS | P1A18FX250ATST | P1L18FX250ATS | P1L18FX250ATST |
| | 30 | 38 | P1C30FX250ATS | P1C30FX250ATST | P1A30FX250ATS | P1A30FX250ATST | P1L30FX250ATS | P1L30FX250ATST |
| | 42 | 44 | P1C42FX250ATS | P1C42FX250ATST | P1A42FX250ATS | P1A42FX250ATST | P1L42FX250ATS | P1L42FX250ATST |
| | 54 | 50 | – | P1C54FX250ATST | – | P1A54FX250ATST | – | P1L54FX250ATST |
| | 66 | 56 | – | P1C66FX250ATST | – | P1A66FX250ATST | – | P1L66FX250ATST |
| 400 | 18 | 56 | P1C18JX400ATS | – | P1A18JX400ATS | – | P1L18JX400ATS | – |
| | 30 | 62 | P1C30JX400ATS | P1C30JX400ATST | P1A30JX400ATS | P1A30JX400ATST | P1L30JX400ATS | P1L30JX400ATST |
| | 42 | 68 | P1C42JX400ATS | P1C42JX400ATST | P1A42JX400ATS | P1A42JX400ATST | P1L42JX400ATS | P1L42JX400ATST |
| | 54 | 74 | – | P1C54JX400ATST | – | P1A54JX400ATST | – | P1L54JX400ATST |
| | 66 ² | 74 ² | – | P1C66JX400ATSN ² | – | P1A66JX400ATSN ² | – | P1L66JX400ATSN ² |

Table P1-18 – Standard Enclosures

| Box Height (in.) | Catalogue Number | | | |
|------------------|----------------------|---------|-------|------------|
| | Type 1 Standard Trim | | | Type 3R/12 |
| | Box | Surface | Flush | |
| 26 (660) | B26 | S26B | F26B | WP26 |
| 32 (813) | B32 | S32B | F32B | WP32 |
| 38 (965) | B38 | S38B | F38B | WP38 |
| 44 (1118) | B44 | S44B | F44B | WP44 |
| 50 (1270) | B50 | S50B | F50B | WP50 |
| 56 (1422) | B56 | S56B | F56B | WP56 |
| 62 (1575) | B62 | S62B | F62B | WP62 |
| 68 (1727) | B68 | S68B | F68B | WP68 |
| 74 (1880) | B74 | S74B | F74B | WP74 |

1 For all products without subfeed space - change "T" at end to "N" and reduce box size by 6" (152 mm).

² No subfeed space only for 400A 66 circuit.

³ BL/BQD/NGB Type Mains are only available as Back-Fed. No kits are available for use in Main or subfeed space. These breakers take up branch circuit space.

⁴ NGB interiors are not available as Non-Fed-Thru, without subfeed space.

Standard Modifications

Type P1 Factory Assembled Panelboards

Panel Options

Enclosures

- 24" wide boxes
- Hinged trims
- Door-in-door trims
- Screw to the box trims
- Piano hinge trims
- Painted boxes
- Custom colours
- Type 3R/12 enclosures
- Type 4X enclosures (SS304 or SS316, surface mounted only)
- Panel skirts
- Relay Cabinet
- Gaskets between trim and box

Surge Protection Devices

TPS3 02

- Bus connected
- Internally mounted (30A breaker required to feed SPD)
- Externally mounted in a 15" high aux, enclosure (30A breaker required to feed SPD)

TPS3 09

- Internally mounted (20A breaker required to feed SPD)
- Externally mounted (20A breaker required to feed SPD)

TPS3 12

- Externally mounted (40A breaker required to feed SPD)

Panel Modifications

- Main Bus
All aluminum bussing is tin-plated.
Optional bussing for the P1 panel is tin-plated copper.
- Compression lug for MLO¹
- Contactor Mains - Mount in 24" enclosure ahead of panel.
 - Asco 920 through 225 amps³
 - Asco 911 through 150 amps³
 - Siemens LEN through 30 amps³
- Branch and main breaker accessories
 - Handle blocking devices
 - Handle padlocking devices
- Feed-thru lugs¹
Cannot be used in conjunction with SPD or subfeed breakers.

| Feed-thru Lugs Amp Rating | Type | Connector CU/AL Range |
|---------------------------|-------------------|---|
| 250 | AL/CU Mechanical | (1) #6 AWG-350 kcmil |
| | CU Mechanical | (1) #6 AWG-350 kcmil |
| | AL/CU Compression | (1) #6 AWG-350 kcmil |
| 400 | AL/CU Mechanical | (2) #1/0 -250 kcmil or (1) #2 AWG-600 kcmil |
| | CU | (1) 1/0-600 kcmil CU or (2) 1/0-4/0 CU |
| | AL/CU Compression | (1) 400-600 kcmil AL (1) 400-500 kcmil CU |

NOTE: Standard compression lugs used are range taking lugs and may require a particular crimping tool to accommodate the range. Consult factory for information.

- 200% neutral^{1,4}
- Copper lugs, mechanical line and branch neutral¹
- Bus mounted SPD¹
- Option for Service Entrance
- Grounding of Panelboards
Ground Bars are shipped with the panel interior.
 - Non-Insulated Equipment Ground Bar – Standard
 - Copper Non-Insulated Ground Bar
 - AL Insulated Equipment Ground Bar
 - CU Insulated Equipment Ground Bar
- Shunt Trip on Main or Branch
BL², BLH², HBL², BQD², BQD6², NGB² as branch use 1" unit space for shunt trip.

QJ2, QJ2-H, QJH2, ED2, ED4, ED6, HED4, FD6, FXD6, HFD6

HFXD6, JXD6, JD6, HJD6, HJXD6, HQJ2H

¹ Do not increase panel or enclosure size.

² Accessories on 1" pole breakers (BL, BQD, NGB) will take 1" unit space.

³ External to the panel, supplied in a separate enclosure.

⁴ Not available with service entrance equipment.

Miscellaneous Modifications

Type P1 Factory Assembled Panelboards

Compression Lugs

Table P1-19 – Lugs

| Style | Amp Rating | Breaker Type | Compression Connectors | Box Height Addition |
|--------------|------------|------------------------|--|-------------------------|
| MLO | 125 | N/A | (1) #6 AWG - 350 kcmil | None |
| | 250 | | | |
| Main Breaker | 400 | N/A | (1) 400 - 600 kcmil AL (1) 400 - 500 kcmil CU | None |
| | 125 | ED4, ED6, HED4 | (1) #14 AWG - 2/0 | Box must go to 24" wide |
| | 225 | QJ2, QJH2, QJ2H | (1) #6 AWG - 350 kcmil CU or AL | Box must go to 24" wide |
| | 250 | FD6, FXD6, HFD6, HFXD6 | (1) #6 AWG - 350 kcmil CU or AL | Box must go to 24" wide |

Note: Standard compression lugs used for P1 panels are range taking lugs and require a particular crimping tool (tool is Hubbell/Anderson Versa Crimp VC6 - for 250A) to accommodate the range. Consult factory for information. 200% neutral not available with compression lugs. BL, BQD, NGB breakers cannot accommodate compression lugs. For 400A tool use Hubbell/Anderson Versa Crimp VC6FT/VC7FT - see instruction sheet for details.

Enclosure Modifications

NEMA-4X (SS304 is standard, SS316 optional)
Water Tight, Dust Tight and Corrosion Resistant

Table P1-20

| Catalogue Number | Enclosure – Stainless Steel Size (inches) (304SS is standard) | | |
|------------------|--|----|------|
| | H | W | D |
| B4X26 | 26 | 20 | 5.75 |
| B4X32 | 32 | 20 | 5.75 |
| B4X38 | 38 | 20 | 5.75 |
| B4X44 | 44 | 20 | 5.75 |
| B4X50 | 50 | 20 | 5.75 |
| B4X56 | 56 | 20 | 5.75 |
| B4X62 | 62 | 20 | 5.75 |
| B4X68 | 68 | 20 | 5.75 |
| B4X74 | 74 | 20 | 5.75 |

Remote Switch Modifications

Table P1-21 – Remote Control Switch Modification

| Description |
|---|
| Auxiliary Contacts (mounted, not wired) |
| 2-Wire Control |

Table P1-22 – Applications for a Remote Switch

| Switch Type | Modification |
|-------------|--|
| 920 | Mounts in 24" H relay cabinet as a main only |
| LEN | 30A mounts in 24" H relay cabinet as a main only |

Dimensions

Type P1 Panelboards

Type 1 Box

Box is symmetrical

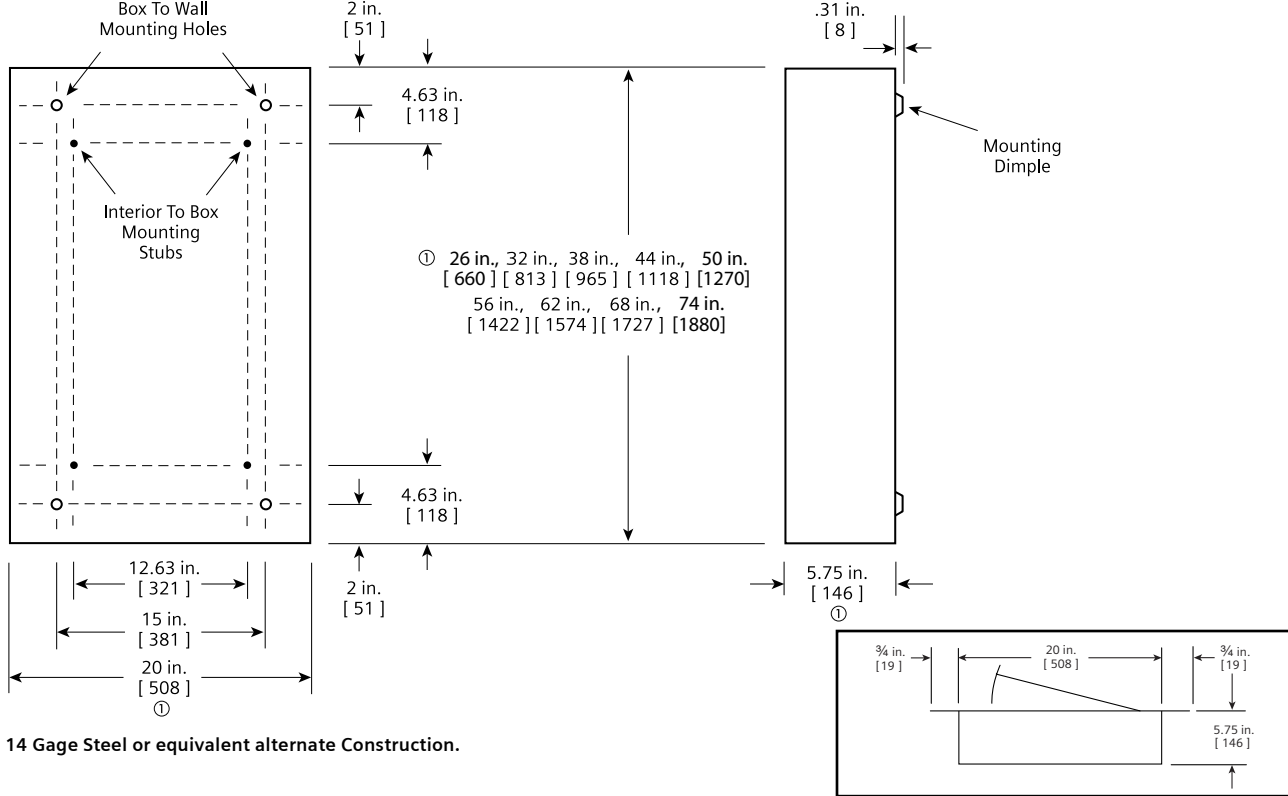

Type 3R/12 Box

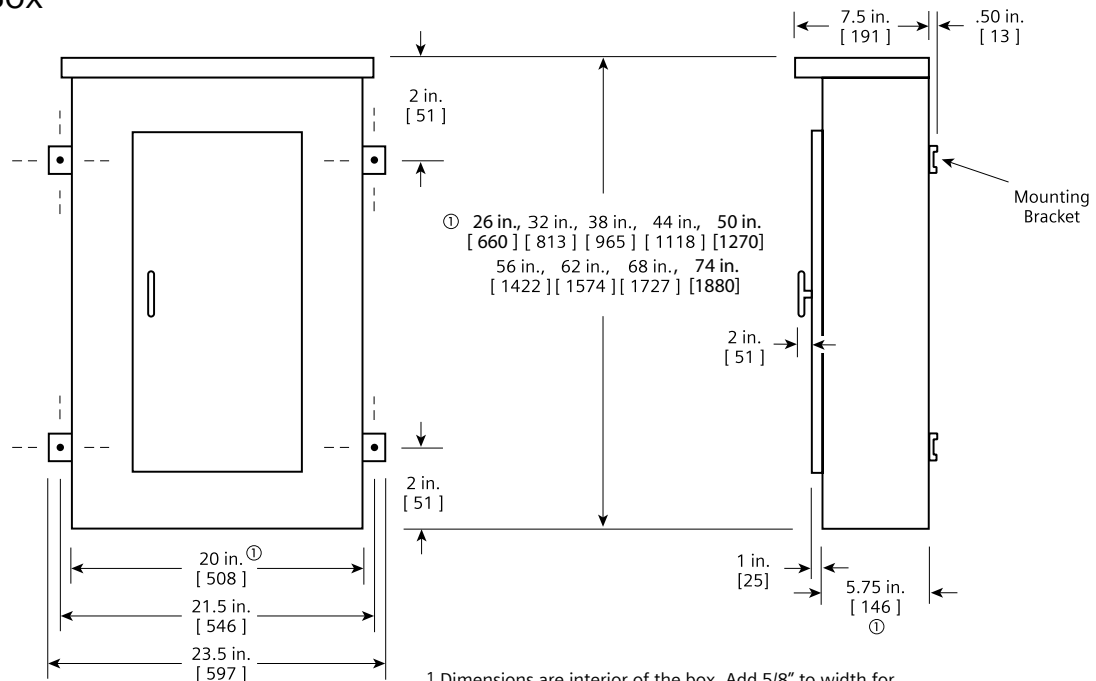

16 Gage Steel Can with 14 Gage front or similar approved construction.

1 Dimensions are interior of the box. Add 5/8" to width for absolute dimension. Add 1/8" to height for absolute dimension.

Dimensions shown in inches [millimeters].

Dimensions

Panelboards - Trim / Front

Standard Trim (FAS-Latch) Typical Dimensions (Hinges available as shown on right side only) (Typical 14 Gage Steel construction or approved equivalent)

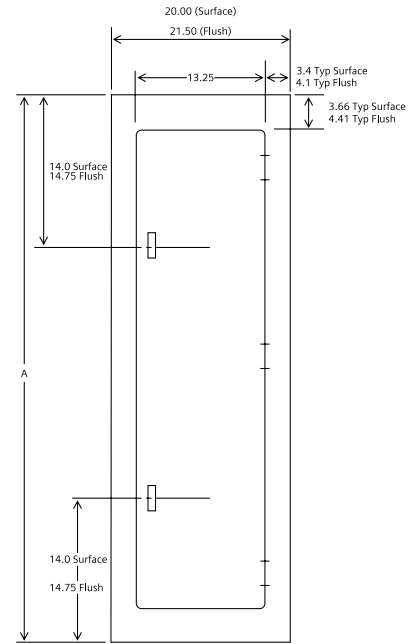
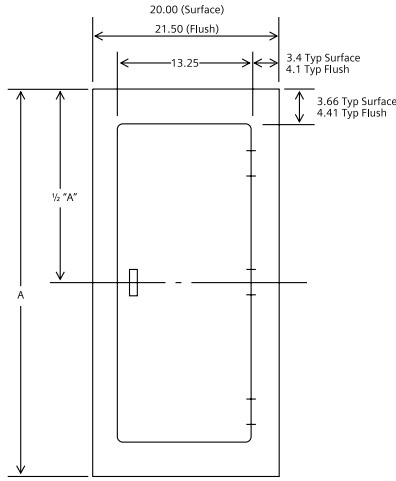

| Dimensions in inches (mm) | | | |
|---------------------------|-----------|-------------|-------------|
| | Surface | Flush | # of Hinges |
| Box Size | A | A | |
| 26 (660) | 26 (660) | 27.5 (699) | 2 |
| 32 (813) | 32 (813) | 33.5 (851) | 2 |
| 38 (965) | 38(965) | 39.5 (1003) | 2 |
| 44 (1118) | 44 (1118) | 45.5 (1156) | 3 |
| 50 (1270) | 50 (1270) | 52.5 (1334) | 3 |

| Dimensions in inches (mm) | | | |
|---------------------------|-----------|-------------|-------------|
| | Surface | Flush | # of Hinges |
| Box Size | A | A | |
| 56 (1422) | 56 (1422) | 57.5 (1461) | 3 |
| 62 (1574) | 62 (1574) | 63.5 (1613) | 3 |
| 68 (1727) | 68 (1727) | 69.5 (1765) | 3 |
| 74(1880) | 74(1880) | 75.5 (1918) | 3 |

**Standard Trim (FAS-Latch)
(14 Gage Standard - no options)
(Into stock includes surface or flush
versions.)**



**Door in Door Front
(14 Gage Standard)**



Hinged Front

Also available

- Screw to Box Trim (14 Gage Std.)
- Piano Hinge Trim

Next Gen P1 Into stock Panelboards

To better serve the needs of customers, into stock program offers product flexibility, quicker job turn-around, and affordable pricing. All Siemens into stock panelboards are fully backed for high quality, trouble-free operations.

Flexibility and ease of assembly:

Customer oriented design creates installation convenience. For all of its one-of-a-kind features, the P1 panelboard is also designed to be extremely user friendly. For instance, field convertible main breaker and main lug kits - (through 400 amps), will allow you to switch from main lug to main breaker, and vice versa with no change in box size or additional cabling. Plus, lay-in construction (for 250 A CU) and/or removable lugs make wiring the main and neutral lugs easier and faster. To further speed

wiring, as well as reduce clutter, the P1 panel also features a split neutral design and branch neutral connections. Additionally, field addable sub-fed breakers (up to 250 amps) or feed through lug kits can be field installed without utilizing any of your feeder breaker positions or increasing your box height. Furthermore, the unique design allows the panel to be inverted in the field and keep its labeling legible.

1) Completely symmetrical boxes may be mounted with either end up. There are four pre-punched equipment ground connector locations for contractor friendly installation.

2) Box comes pre-punched for optional, field installable door-in-door or hinged style trims. The panel box will accept both standard ground connector (EGK and ECGK) assemblies and insulated ground connector kits (IGK and ICGK).

3) Interior is completely symmetrical allowing it to be changed from top to bottom feed by simply rotating the interior.

4) Choose either a Main Breaker kit or Main Lug kit with which to terminate your incoming cables. Main lug kits are contractor friendly lugs through 350 kcmil (250 amp panel) or (1) 600 kcmil or (2) 250 kcmil connectors for 400 amp panels. Main Breaker kits (250 amps and below) are horizontally mounted allowing field convertible top or bottom feeds to be performed easily. Main Lug kits and Main Breaker kits are interchangeable and can be changed/added in the field without making changes to the enclosure or interior.

5) Branch neutral connections are near the breaker connections to speed wiring and reduce clutter. The standard P1 neutral is rated for 100% of the panel's ampacity and will accept copper or aluminum wire. Optional 200% and 2/0 neutrals are also available.

6) The panel includes space to add (1) subfeed breaker (max 250 amps), feed-thru lugs or TPS3 (SPD) kit.

7) Siemens standard trim has hidden hinges and mounting hardware for added safety. The rounded door corners not only enhance the panel's appearance but also help to eliminate injuries caused from sharp corners.

8) Semi-flush lock comes standard. Easily identified locked position denoted by keyway being horizontal when door has been locked.

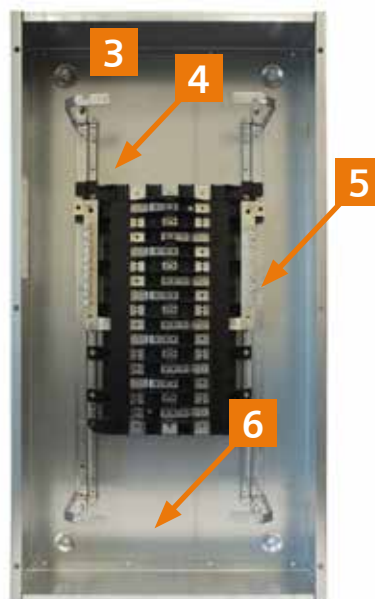
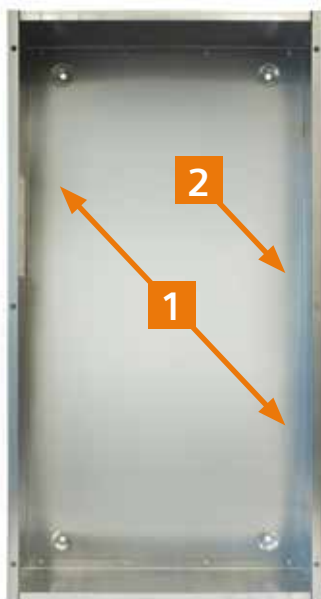

Catalogue Numbering System

Into stock panelboards

Type P1 into stock panelboards are completely convertible from main lug to main breaker and vice-versa. Additionally feed-thru lugs, or subfeed circuit breakers up to 400 ampere can be added without increasing the box height for Next Gen P1 with "T" suffix, see the chart.

1. Compute total number of poles to determine interior catalogue number. (Note: BL / BQD (or) NGB Main Breaker will use unit space. The total number of poles should include 2 (or) 3 poles for 1-phase (or) 3-phase mains.)
2. List catalogue number of interior, box and front.
3. Select main lug kit or main breaker kit from appropriate tables.

Note: Main/Subfeed Breaker mounting kits may be ordered with or without breakers included, see page 5 and 6 for selection.

4. List required branch circuit breakers.
5. Select any modifications or accessories.

Note: Next Gen P1 was introduced in June 2015. All original P1 devices do not include the "Subfeed Space" indicator ("T" suffix). All original P1 included the Subfeed Space as standard.

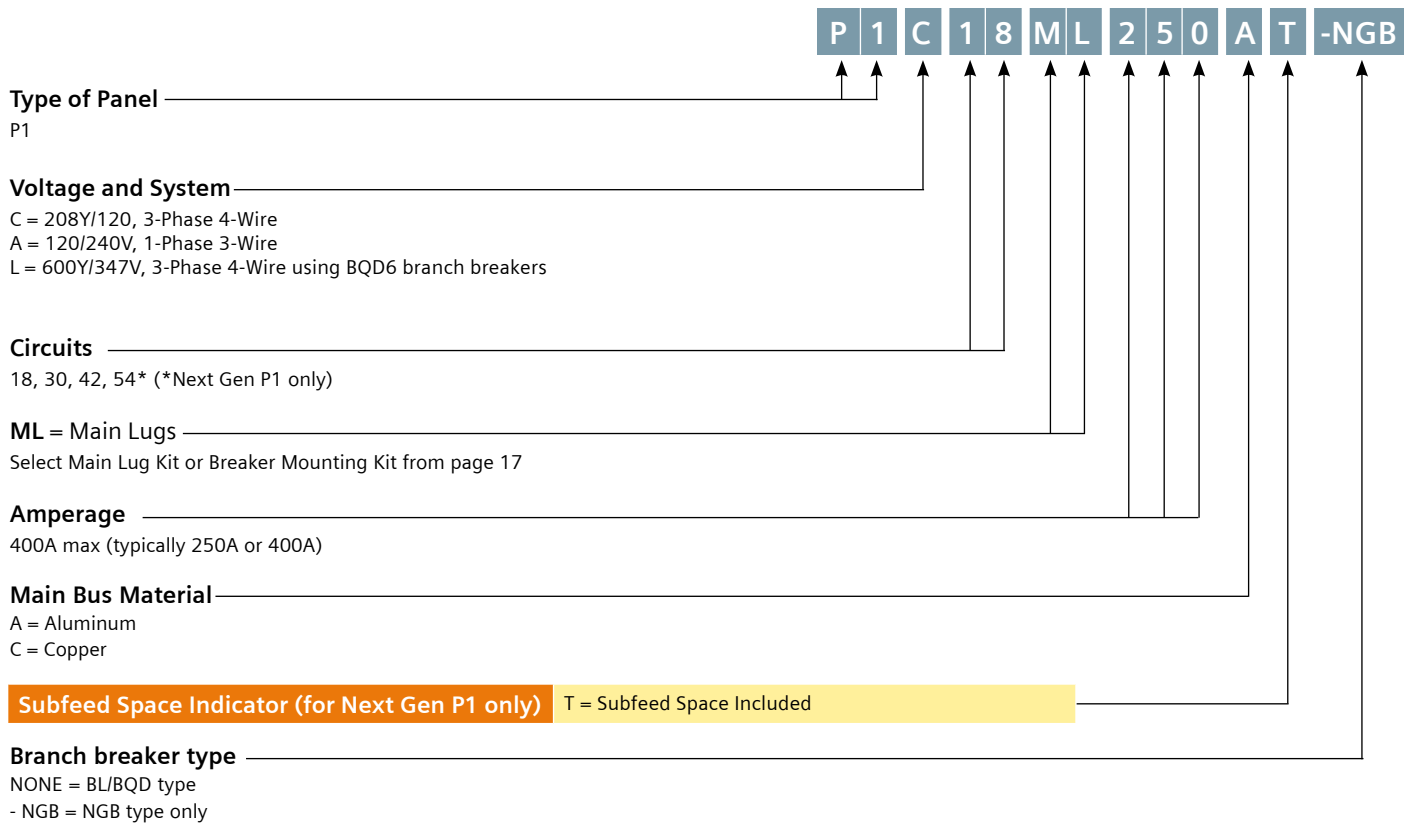

Note: Standard bussing in P1 and Next Gen P1 panels is tin plated for aluminum and copper. Standard bus is rated to the maximum amperage in the panel.

Branch Breakers

| Panel Type | Voltage (Max.) | Breaker Type | Additional Information |
|------------|------------------|-------------------------------------|------------------------|
| Next Gen P | 240 600 / 347 | BL, BLH, HBL, BQD, NGB BQD6, NGB | See Page 17 |

Distributor Stock

Type P1 Panelboards

400A Max. — 20" Wide x 5.75" Deep

1. Choose the appropriate Interior from the table below.
2. Choose the Main Device: Main Lugs from page 16, Main Breaker Kit from pages 16 - 17.
3. Choose Branch Breakers. BL, BQD and NGB breakers from page 19.
4. Choose Feed-Thru Lugs or Subfeed Breaker Kit from pages 16 - 17.



Type P1 Into Stock Panelboards (Next Gen P1 introduced in June 2015)

| Amps | Max. # of Poles | Original Main Lugs Interior Catalogue Number | Next Gen P1 Main Lug Interior Catalogue Number | Original Main Convertible Interior Catalogue Number | Next Gen P1 Main Convertible Interior Catalogue Number | Box Size | Type 1 Encl. | Type 3R/12 Encl. ① | Type 1 Front Surface | Type 1 Front Flush |
|---|-----------------|--|--|---|--|----------|--------------|--------------------|----------------------|--------------------|
| 1-Phase, 3-Wire 120/240V | | | | | | | | | | |
| 250 | 18 | P1A18ML250A | P1A18MC250AT | P1A18MC250A | P1A18MC250AT | 32 | B32 | WP32 | S32B | F32B |
| | 30 | P1A30ML250A | P1A30ML250AT | P1A30MC250A | P1A30MC250AT | 38 | B38 | WP38 | S38B | F38B |
| | 42 | P1A42ML250A | P1A42ML250AT | P1A42MC250A | P1A42MC250AT | 44 | B44 | WP44 | S44B | F44B |
| 400 | 18 | P1A18ML400A | — | P1A18MC400A | — | 50 | B50 | WP50 | S50B | F50B |
| | 30 | P1A30ML400A | P1A30ML400AT | P1A30MC400A | P1A30MC400AT | 62 | B62 | WP62 | S62B | F62B |
| | 42 | P1A42ML400A | P1A42ML400AT | P1A42MC400A | P1A42MC400AT | 68 | B68 | WP68 | S68B | F68B |
| 250 | 18 | P1A18ML250C | P1A18ML250CT | P1A18MC250C | P1A18MC250CT | 32 | B32 | WP32 | S32B | F32B |
| | 30 | P1A30ML250C | P1A30ML250CT | P1A30MC250C | P1A30MC250CT | 38 | B38 | WP38 | S38B | F38B |
| | 42 | P1A42ML250C | P1A42ML250CT | P1A42MC250C | P1A42MC250CT | 44 | B44 | WP44 | S44B | F44B |
| 400 | 18 | P1A18ML400C | — | P1A18MC400C | — | 50 | B50 | WP50 | S50B | F50B |
| | 30 | P1A30ML400C | P1A30ML400CT | P1A30MC400C | P1A30MC400CT | 62 | B62 | WP62 | S62B | F62B |
| | 42 | P1A42ML400C | P1A42ML400CT | P1A42MC400C | P1A42MC400CT | 68 | B68 | WP68 | S68B | F68B |
| 3-Phase, 4-Wire 208Y/120V | | | | | | | | | | |
| 250 | 18 | P1C18ML250A | P1C18ML250AT | P1C18MC250A | P1C18MC250AT | 32 | B32 | WP32 | S32B | F32B |
| | 30 | P1C30ML250A | P1C30ML250AT | P1C30MC250A | P1C30MC250AT | 38 | B38 | WP38 | S38B | F38B |
| | 42 | P1C42ML250A | P1C42ML250AT | P1C42MC250A | P1C42MC250AT | 44 | B44 | WP44 | S44B | F44B |
| 400 | 18 | P1C18ML400A | — | P1C18MC400A | — | 50 | B50 | WP50 | S50B | F50B |
| | 30 | P1C30ML400A | P1C30ML400AT | P1C30MC400A | P1C30MC400AT | 62 | B62 | WP62 | S62B | F62B |
| | 42 | P1C42ML400A | P1C42ML400AT | P1C42MC400A | P1C42MC400AT | 68 | B68 | WP68 | S68B | F68B |
| 250 | 18 | P1C18ML250C | P1C18ML250CT | P1C18MC250C | P1C18MC250CT | 32 | B32 | WP32 | S32B | F32B |
| | 30 | P1C30ML250C | P1C30ML250CT | P1C30MC250C | P1C30MC250CT | 38 | B38 | WP38 | S38B | F38B |
| | 42 | P1C42ML250C | P1C42ML250CT | P1C42MC250C | P1C42MC250CT | 44 | B44 | WP44 | S44B | F44B |
| 400 | 18 | P1C18ML400C | — | P1C18MC400C | — | 50 | B50 | WP50 | S50B | F50B |
| | 30 | P1C30ML400C | P1C30ML400CT | P1C30MC400C | P1C30MC400CT | 62 | B62 | WP62 | S62B | F62B |
| | 42 | P1C42ML400C | P1C42ML400CT | P1C42MC400C | P1C42MC400CT | 68 | B68 | WP68 | S68B | F68B |
| 3-Phase, 4-Wire 600Y/347V | | | | | | | | | | |
| 250 | 18 | P1L18ML250A | P1L18ML250AT | P1L18MC250A | P1L18MC250AT | 32 | B32 | WP32 | S32B | F32B |
| | 30 | P1L30ML250A | P1L30ML250AT | P1L30MC250A | P1L30MC250AT | 38 | B38 | WP38 | S38B | F38B |
| | 42 | P1L42ML250A | P1L42ML250AT | P1L42MC250A | P1L42MC250AT | 44 | B44 | WP44 | S44B | F44B |
| 400 | 18 | P1L18ML400A | — | P1L18MC400A | — | 50 | B50 | WP50 | S50B | F50B |
| | 30 | P1L30ML400A | P1L30ML400AT | P1L30MC400A | P1L30MC400AT | 62 | B62 | WP62 | S62B | F62B |
| | 42 | P1L42ML400A | P1L42ML400AT | P1L42MC400A | P1L42MC400AT | 68 | B68 | WP68 | S68B | F68B |
| 250 | 18 | P1L18ML250C | P1L18ML250CT | P1L18MC250C | P1L18MC250CT | 32 | B32 | WP32 | S32B | F32B |
| | 30 | P1L30ML250C | P1L30ML250CT | P1L30MC250C | P1L30MC250CT | 38 | B38 | WP38 | S38B | F38B |
| | 42 | P1L42ML250C | P1L42ML250CT | P1L42MC250C | P1L42MC250CT | 44 | B44 | WP44 | S44B | F44B |
| 400 | 18 | P1L18ML400C | — | P1L18MC400C | — | 50 | B50 | WP50 | S50B | F50B |
| | 30 | P1L30ML400C | P1L30ML400CT | P1L30MC400C | P1L30MC400CT | 62 | B62 | WP62 | S62B | F62B |
| | 42 | P1L42ML400C | P1L42ML400CT | P1L42MC400C | P1L42MC400CT | 68 | B68 | WP68 | S68B | F68B |
| Interiors for NGB Breakers — 3-Phase, 4-Wire 600Y/347V | | | | | | | | | | |
| 250 | 18 | — | P1L18ML250AT-NGB | — | P1L18MC250AT-NGB | 32 | B32 | WP32 | S32B | F32B |
| | 30 | — | P1L30ML250AT-NGB | — | P1L30MC250AT-NGB | 38 | B38 | WP38 | S38B | F38B |
| | 42 | — | P1L42ML250AT-NGB | — | P1L42MC250AT-NGB | 44 | B44 | WP44 | S44B | F44B |
| 400 | 18 | — | P1L54ML250AT-NGB | — | P1L54MC250AT-NGB | 50 | B50 | WP50 | S50B | F50B |
| | 30 | — | P1L30ML400AT-NGB | — | P1L30MC400AT-NGB | 62 | B62 | WP62 | S62B | F62B |
| | 42 | — | P1L42ML400AT-NGB | — | P1L42MC400AT-NGB | 68 | B68 | WP68 | S68B | F68B |
| 250 | 18 | — | P1L54ML400AT-NGB | — | P1L54MC400AT-NGB | 74 | B74 | WP74 | S74B | F74B |
| | 30 | — | P1L18ML250CT-NGB | — | P1L18MC250CT-NGB | 32 | B32 | WP32 | S32B | F32B |
| | 42 | — | P1L30ML250CT-NGB | — | P1L30MC250CT-NGB | 38 | B38 | WP38 | S38B | F38B |
| 400 | 18 | — | P1L42ML250CT-NGB | — | P1L42MC250CT-NGB | 44 | B44 | WP44 | S44B | F44B |
| | 30 | — | P1L54ML250CT-NGB | — | P1L54MC250CT-NGB | 50 | B50 | WP50 | S50B | F50B |
| | 42 | — | P1L30ML400CT-NGB | — | P1L30MC400CT-NGB | 62 | B62 | WP62 | S62B | F62B |
| 400 | 18 | — | P1L42ML400CT-NGB | — | P1L42MC400CT-NGB | 68 | B68 | WP68 | S68B | F68B |
| | 30 | — | P1L54ML400CT-NGB | — | P1L54MC400CT-NGB | 74 | B74 | WP74 | S74B | F74B |



42 circuit with Back-fed Main



54 circuit 400A

① Front included in type 3R/12 Box.

Product Category into stock

Distributor Stock

Type P1 Panelboards

Lug Kits — Main or Feed Thru

| Amp Rating | Matl. | Wire Range (includes Neutral) | Service | Original P1 Catalogue Number | Next Gen P1 Catalogue Number |
|------------|-------|---|--------------------|------------------------------|------------------------------|
| 250 | AL | (1) #6 AWG-350 kcmil (CU or AL) | 1 Phase 3 Phase | MLKA1 MLKA3 | MLKA1A MLKA3A |
| | CU | (1) #6 AWG-350 kcmil (CU or AL) | 1 Phase 3 Phase | MLKC1 MLKC3 | MLKC1A MLKC3A |
| 400 | AL | (2) 1/0 - 250 kcmil or (1) #2 AWG-600 kcmil | 1 Phase 3 Phase | 4MLKA1 4MLKA3 | 4MLKA1A 4MLKA3A |
| | CU | (1) 1/0-600 kcmil CU or (2) 1/0-4/0 CU | 1 Phase 3 Phase | 4MLKC1 4MLKC3 | 4MLKC1A 4MLKC3A |
| 400 | AL | AL 1/0-750 kcmil (max. 600 kcmil CU wire) | 1 Phase 3 Phase | — — | 4MLKA1B 4MLKA3B |

Breaker Mounting Kits — Main or Subfeed Strap Kit w/o Breaker

| Ampere Rating | Breaker Types | Service | Original P1 Catalogue Number | Next Gen P1 Catalogue Number |
|-------------------|------------------------------|--------------------|------------------------------|---|
| 100A | BQD | 3-Phase | MBKBC3 | Use Back-fed Main Label Kit # MBKBFA [Ⓜ] (includes Neutral Lug, "MAIN" label and instructions) |
| 100A | BL, BLH, HBL | 1-Phase 3-Phase | MBKBL1 MBKBL3 | |
| 125A | NGB | 1-Phase 3-Phase | — — | |
| 125A | ED4, ED6, HED4 | 1-Phase 3-Phase | MBKED1 MBKED3 | MBKED1A MBKED3A |
| 225A | QJ2, QJH2, QJ2-H | 1-Phase 3-Phase | MBKQJ1 MBKQJ3 | MBKQJ1A MBKQJ3A |
| 250A | FXD6, FD6, HFD6, HFXD6 | 1-Phase 3-Phase | MBKFD1 MBKFD3 | MBKFD1A MBKFD3A |
| 400A [Ⓜ] | JXD2, JD6, JXD6, HJD6, HJXD6 | 1-Phase 3-Phase | MBKJD1 MBKJD3 | MBKJD1A MBKJD3A |

[Ⓜ] 400 amp kit is for main only — not allowed for subfeed breaker.
[Ⓜ] Back-fed main occupies branch space.

Copper Neutral Lug Kits — 250A

| Number of Circuits | Description | Original P1 Catalogue Number | Next Gen P1 Catalogue Number |
|--------------------|--|------------------------------|------------------------------|
| 18 | 2 or 4 Branch Neutral Strips, 1 Main Neutral Lug, Hardware | CNKL18 | Use 30 ckt kit |
| 30 | | CNKL30 | CNLK30A |
| 42 | | CNKL42 | CNLK42A |
| 54, 66 | | — | CNLK54A |

2/0 Neutral Lug Kits — 250A and 400A

| Number of Circuits | Description | Original P1 Catalogue Number | Next Gen P1 Catalogue Number |
|--------------------|--|------------------------------|------------------------------|
| 18 | 2 or 4 Branch Neutral Strips, 1 Main Neutral Lug, Hardware | — | Use 30 ckt kit |
| 30 | | — | LNLK30A |
| 42 | | — | LNLK42A |
| 54, 66 | | — | LNLK54A |

200% Neutral Lug Kits - 250A

| Number of Circuits | Description | Original P1 Catalogue Number | Next Gen P1 Catalogue Number |
|--------------------|--|------------------------------|------------------------------|
| 18 | 2 or 4 Branch Neutral Strips, 1 Main Neutral Lug, Hardware | 2NLK18 | Use 30 ckt kit |
| 30 | | 2NLK30 | 2NLK30A |
| 42 | | 2NLK42 | 2NLK42A |
| 54, 66 | | — | 2NLK54A |

200% Neutral Lug Kits - 400A

| Number of Circuits | Description | Original P1 Catalogue Number | Next Gen P1 Catalogue Number |
|--------------------|---|------------------------------|------------------------------|
| 18 | 2 or 4 Branch Neutral Strips, 1 Main 600MCM Neutral Lug, Hardware | 42NLK18 | Use 30 ckt kit |
| 30 | | 42NLK30 | 42NLK30A |
| 42 | | 42NLK42 | 42NLK42A |
| 54, 66 | | — | 42NLK54A |

[Ⓜ] Replacement Parts Only

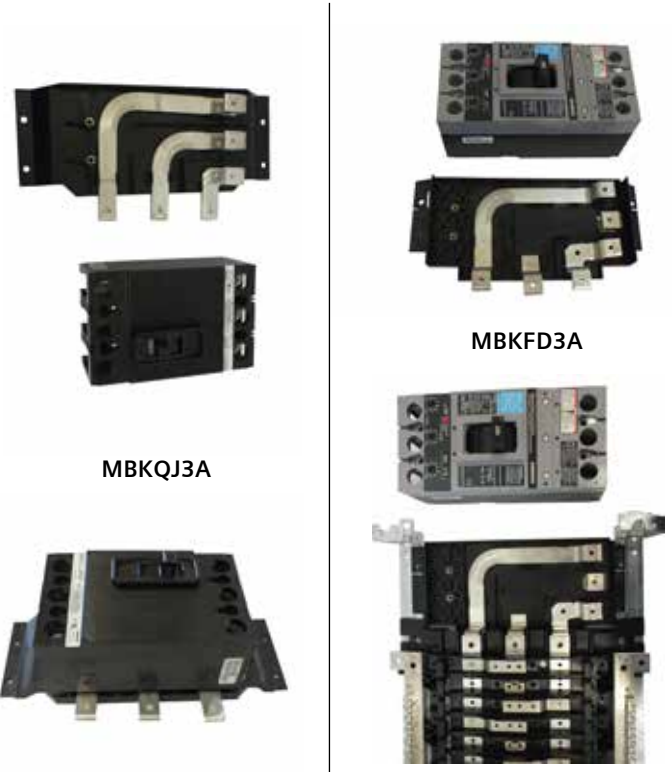

Miscellaneous Parts and Accessories

| Catalogue # | Description |
|--------------------------|---|
| BK1 | Bonding Kit for 250A max. Original P1 panels |
| BK1A | Bonding Kit for 250A max. Next Gen P1 panels |
| IMK1 | Interior Adjusting Kit |
| 11-1824-01 | Directory Card Holder |
| 12-1110-01 | Directory Card |
| 11-1056-01B | Instruction Book |
| NBK03 | Number Strips 1–42. Stick-on type; Use w/ P1 series Panels |
| NBK04 | Number Strips 43–84. Stick-on type; Use w/ P1 series Panels |
| NBK05 | Number Strips 85–126. Stick-on type; Use w/ P1 series Panels |
| NBK06 | Number Strips 127–168. Stick-on type; Use w/ P1 series Panels |
| EGK | AL Ground Bus 44 Connections |
| ECGK | CU Ground Bus 44 Connections |
| IGK | Insulated AL Ground Bus |
| ICGK | Insulated CU Ground Bus |
| P1SCRWS | Package of 42 breaker mounting screws for P1 |
| DFFP1 | 1" Branch circuit filler plate (suitable for replacing QF3-UL in panelboards (Package of 100 filler plates) |
| P1CONBPHCU [Ⓜ] | Connector kit – 6 pcs. B-phase Copper |
| P1CONBPHAL [Ⓜ] | Connector kit – 6 pcs. B-phase Aluminum |
| P1CONACPHCU [Ⓜ] | Connector kit – 6 pcs. A or C-phase Copper |
| P1CONACPHAL [Ⓜ] | Connector kit – 6 pcs. A or C-phase Aluminum |
| MCHK-1 | 1 Metallic directory card holder |
| FPLK2 | 2 Spare Fas-latch trim locks with 2 keys |
| SDKN | Dripshield kit (20" W x 5.75" D) |
| TPS9IKITP1 | Original P1 mounting bracket for SPD TPS3 09 |
| TPS9IKITP1A | Next Gen P1 mounting bracket for SPD TPS3 09 |
| MBKBFA | Back-Fed Main Breaker Kit |

Product Category into stock

Distributor Stock

Main Breaker Mounting Kits with Breakers for P1 Panels (250A and lower can be used as subfeed kits also)

| Original P1 Catalogue Number | Next Gen P1 Catalogue Number | Description | Ratings | |
|---------------------------------|---------------------------------|--------------------------------|---------|------|
| | | | 240V | 600V |
| MBKQJ12225 | MBKQJ12225A | Kit w/2-pole QJ2 125A breaker | 10KA | — |
| MBKQJ33150 | MBKQJ33150A | Kit w/3-pole QJ2 150A breaker | 10KA | — |
| MBKQJ33200 | MBKQJ33200A | Kit w/3-pole QJ2 175A breaker | 10KA | — |
| MBKQJ33225 | MBKQJ33225A | Kit w/3-pole QJ2 200A breaker | 10KA | — |
| MBKED33100 | MBKED33100A | Kit w/3-pole ED6 100A breaker | 65KA | 18KA |
| MBKED33125 | MBKED33125A | Kit w/3-pole ED6 125A breaker | 65KA | 18KA |
| MBKFD33200 | MBKFD33200A | Kit w/3-pole FXD6 200A breaker | 65KA | 22KA |
| MBKFD33225 | MBKFD33225A | Kit w/3-pole FXD6 225A breaker | 65KA | 22KA |
| MBKFD33250 | MBKFD33250A | Kit w/3-pole FXD6 250A breaker | 65KA | 22KA |
| MBKHF33250 | MBKHF33250A | Kit w/3-pole HFD6 250A breaker | 100KA | 25KA |
| MBKJD33400 | MBKJD33400A | Kit w/3-pole JD6 400A breaker | 65KA | 25KA |

NOTE: "Next Gen P1" kits above only work for interior numbers ending in "T" or "N".
Use "Original P1" kits for all others.

AFCI – Branch Feeder Type Arc Fault Circuit Interrupter

| Breaker Type | Ampere Rating | Catalogue Number | Interrupting Ratings (kA) RMS Symmetrical Amperes | | |
|-----------------|------------------|---------------------|--|---------|-----|
| | | | Volts AC | | |
| | | | 120 | 120/240 | 240 |
| BAF2 1-pole | 15 | BA115AF | 10 | — | — |
| | 20 | BA120AF | 10 | — | — |
| BAF2H 1-pole | 15 | BA115AFH | 22 | — | — |
| | 20 | BA120AFH | 22 | — | — |
| HBAF2 1-pole | 15 | BA115AFHH | 65 | — | — |
| | 20 | BA120AFHH | 65 | — | — |

GFCI Personnel Protection (5MA)

| Breaker Type | Ampere Rating | Catalogue Number | Interrupting Ratings (kA) RMS Symmetrical Amperes | | |
|------------------|------------------|---------------------|--|---------|-----|
| | | | Volts AC | | |
| | | | 120 | 120/240 | 240 |
| BLF 1-Pole | 15 | BF115 | 10 | — | — |
| | 20 | BF120 | 10 | — | — |
| | 25 | BF125 | 10 | — | — |
| | 30 | BF130 | 10 | — | — |
| BLF 2-Pole | 15 | BF215 | — | 10 | — |
| | 20 | BF220 | — | 10 | — |
| | 30 | BF230 | — | 10 | — |
| | 40 | BF240 | — | 10 | — |
| | 50 | BF250 | — | 10 | — |
| | 60 | BF260 | — | 10 | — |
| BLHF 1-Pole | 15 | BF115H | 22 | — | — |
| | 20 | BF120H | 22 | — | — |
| | 30 | BF130H | 22 | — | — |
| BLHF 2-Pole | 15 | BF215H | — | 22 | — |
| | 20 | BF220H | — | 22 | — |
| | 30 | BF230H | — | 22 | — |
| | 40 | BF240H | — | 22 | — |
| | 50 | BF250H | — | 22 | — |
| | 60 | BF260H | — | 22 | — |
| HBFGA2 1-pole | 15 | BA115DFHH | 65 | — | — |
| | 20 | BA120DFHH | 65 | — | — |

Product Category Into Stock

Branch Breakers Selection for P1

Selection Guide

1. Select breaker type.
2. Select required amperage.
3. Select number of poles.
4. Select branch breaker catalogue numbers.
5. Select ground bar and filler plates. (See replacement parts & accessories on Page 15.)



300A Main installed.
These Next Gen P1 kits can now be used as top or bottom feed.

AFCI-Combination Type Arc Fault Circuit Interrupter

| Breaker Type | Ampere Rating | Catalogue Number | Interrupting Ratings (kA) RMS Symmetrical Amperes | | |
|-----------------|------------------|---------------------|--|---------|-----|
| | | | Volts AC | | |
| | | | 120 | 120/240 | 240 |
| BAF2 1-pole | 15 | B115AFC | 10 | — | — |
| | 20 | B120AFC | 10 | — | — |
| BAFH2 1-pole | 15 | B115AFCH | 22 | — | — |
| | 20 | B120AFCH | 22 | — | — |
| HBAF2 1-pole | 15 | BA115AFCHH | 65 | — | — |
| | 20 | BA120AFCHH | 65 | — | — |
| BAF 2-pole | 15 | B215AFC | 10 | — | — |
| | 20 | B220AFC | 10 | — | — |
| BAFH 2-pole | 15 | B215AFCH | 22 | — | — |
| | 20 | B220AFCH | 22 | — | — |

Dual Function AFCI/GFCI Circuit Breaker

| Breaker Type | Ampere Rating | Catalogue Number | Interrupting Ratings (kA) RMS Symmetrical Amperes | | |
|------------------|------------------|---------------------|--|---------|-----|
| | | | Volts AC | | |
| | | | 120 | 120/240 | 240 |
| BFGA2 1-pole | 15 | BA115DF | 10 | — | — |
| | 20 | BA120DF | 10 | — | — |
| BFGAH2 1-pole | 15 | BA115DFH | 22 | — | — |
| | 20 | BA120DFH | 22 | — | — |
| HBFGA2 1-pole | 15 | BA115DFHH | 65 | — | — |
| | 20 | BA120DFHH | 65 | — | — |

Switching Neutrals

| Breaker Type | Ampere Rating | Catalogue Number | Maximum Interrupting Rating (kA) | | |
|-----------------------------|------------------|---------------------|----------------------------------|-------------|---------|
| | | | 120V AC | 120/240V AC | 240V AC |
| BG 2-Wire Common Trip | 15 | BG215* | 10 | — | — |
| | 20 | BG220* | 10 | — | — |
| | 30 | BG230* | 10 | — | — |
| BG 3-Wire Common Trip | 15 | BG315* | — | 10 | — |
| | 20 | BG320* | — | 10 | — |
| | 30 | BG330* | — | 10 | — |

* Built to order.

Distributor Stock

Type P1 Panelboards

Branch Breakers Selection for P1

Selection Guide

1. Select breaker type.
2. Select required amperage.
3. Select number of poles.
4. Select branch breaker catalogue numbers.
5. Select ground bar and filler plates.
(See replacement parts & accessories on Pages 17 and 18.)

BL Branch Breakers – 10,000A IR^②

| Amp Rating | 1-Pole 120/240V | 2-Pole 120/240V | 3-Pole 240V |
|------------|-----------------|-----------------|-------------|
| 15 | B115 | B215 | B315 |
| 20 | B120 | B220 | B320 |
| 25 | B125 | B225 | B325 |
| 30 | B130 | B230 | B330 |
| 35 | B135 | B235 | B335 |
| 40 | B140 | B240 | B340 |
| 45 | B145 | B245 | B345 |
| 50 | B150 | B250 | B350 |
| 55 | B155 | — | — |
| 60 | B160 | B260 | B360 |
| 70 | B170 | B270 | B370 |
| 80 | — | B280 | B380 |
| 90 | — | B290 | B390 |
| 100 | — | B2100 | B3100 |

BLH Branch Breakers – 22,000A IR^②

| Amp Rating | 1-Pole 120/240V | 2-Pole 120/240V | 3-Pole 240V |
|------------|-----------------|-----------------|-------------|
| 15 | B115H | B215H | B315H |
| 20 | B120H | B220H | B320H |
| 25 | B125H | B225H | B325H |
| 30 | B130H | B230H | B330H |
| 40 | B140H | B240H | B340H |
| 50 | B150H | B250H | B350H |
| 55 | B155H | — | — |
| 60 | B160H | B260H | B360H |
| 70 | B170H | B270H | B370H |
| 80 | — | B280H | B380H |
| 90 | — | B290H | B390H |
| 100 | — | B2100H | B3100H |

HBL Branch Breakers – 65,000A IR^②

| Amp Rating | 1-Pole 120/240V | 2-Pole 120/240V | 3-Pole 240V |
|------------|-----------------|-----------------|-------------|
| 15 | B115HH | B215HH | B315HH |
| 20 | B120HH | B220HH | B320HH |
| 30 | B130HH | B230HH | B330HH |
| 40 | B140HH | B240HH | B340HH |
| 50 | B150HH | B250HH | B350HH |
| 60 | — | B260HH | B360HH |
| 70 | — | B270HH | B370HH |
| 80 | — | B280HH | B380HH |
| 90 | — | B290HH | B390HH |
| 100 | — | B2100HH | B3100HH |

BQD Branch Breakers – 65,000A IR max. @ 240 Vac^③

| Amp Rating | 1-Pole 120/240V | 2-Pole 120/240V | 3-Pole 240V |
|------------|-----------------|-----------------|-------------|
| 15 | BQD115 | BQD215 | BQD315 |
| 20 | BQD120 | BQD220 | BQD320 |
| 25 | BQD125 | BQD225 | BQD325 |
| 30 | BQD130 | BQD230 | BQD330 |
| 35 | BQD135 | BQD235 | BQD335 |
| 40 | BQD140 | BQD240 | BQD340 |
| 45 | BQD145 | BQD245 | BQD345 |
| 50 | BQD150 | BQD250 | BQD350 |
| 60 | BQD160 | BQD260 | BQD360 |
| 70 | BQD170 | BQD270 | BQD370 |
| 80 | BQD180 | BQD280 | BQD380 |
| 90 | BQD190 | BQD290 | BQD390 |
| 100 | BQD1100 | BQD2100 | BQD3100 |

BQD6 Branch Breakers – 10,000A IR max @ 600/347V

| Amp Rating | 1-Pole 347V | 2-Pole 120/240V | 3-Pole 240V |
|------------|-------------|-----------------|-------------|
| 15 | BQD6115 | BQD6215 | BQD6315 |
| 20 | BQD6120 | BQD6220 | BQD6320 |
| 25 | BQD6125 | BQD6225 | BQD6325 |
| 30 | BQD6130 | BQD6230 | BQD6330 |
| 35 | BQD6135 | BQD6235 | BQD6335 |
| 40 | BQD6140 | BQD6240 | BQD6340 |
| 45 | BQD6145 | BQD6245 | BQD6345 |
| 50 | BQD6150 | BQD6250 | BQD6350 |
| 60 | BQD6160 | BQD6260 | BQD6360 |
| 70 | BQD6170 | BQD6270 | BQD6370 |

NGB Branch Breakers

14,000 A IR Max. @ 600Y/347V/ 100,000 A IR @ 240V AC

| Amp Rating | 1-pole 347V | 2-pole 600Y/347V | 3-pole 600Y/327V |
|------------|-------------|------------------|------------------|
| 15 | NGB1B015B | NGB2B015B | NGB3B015B |
| 20 | NGB1B020B | NGB2B020B | NGB3B020B |
| 25 | NGB1B025B | NGB2B025B | NGB3B025B |
| 30 | NGB1B030B | NGB2B030B | NGB3B030B |
| 35 | NGB1B035B | NGB2B035B | NGB3B035B |
| 40 | NGB1B040B | NGB2B040B | NGB3B040B |
| 45 | NGB1B045B | NGB2B045B | NGB3B045B |
| 50 | NGB1B050B | NGB2B050B | NGB3B050B |
| 60 | NGB1B060B | NGB2B060B | NGB3B060B |
| 70 | NGB1B070B | NGB2B070B | NGB3B070B |
| 80 | NGB1B080B | NGB2B080B | NGB3B080B |
| 90 | NGB1B090B | NGB2B090B | NGB3B090B |
| 100 | NGB1B100B | NGB2B100B | NGB3B100B |
| 110 | NGB1B110B | NGB2B110B | NGB3B110B |
| 125 | NGB1B125B | NGB2B125B | NGB3B125B |

n Built to order. Allow 2–3 weeks for delivery.
① HACR rated.

② To add shunt trip to BL breakers, see Power Product Catalogue for Breaker Accessories.

③ To add shunt trip to BQD breakers, see Power Product Catalogue for Breaker Accessories.

TPS3 02

Surge Protection Device (SPD) for Revised P1 Lighting Panelboards

Features:

- Mounts internal to:
 - Revised P1 Lighting Panelboards
 - Consult factory for field retrofit in Revised P1 Lighting Panelboards
 - UL 1449 3rd Edition Recognized
 - UL 1283
 - Type 4 SPD intended for use in Type 1 applications (Type 2, cUL)
 - UL Type 1 tested with all internal OCP and safety coordination features included
 - Large block, individually fused, thermally protected, 50 kA MOVs
 - 20 kA I_n (most models)
 - 200 kA SCCR (most models)
 - UL96A Lightning Protection Master Label appropriate (@ 20 kA I_n)
-
- Applications
 - Provides main service or downstream protection for sensitive computer and electronic loads
 - Standard redundancy use: 100 kA per phase
 - Increased redundancy use: 200 kA per phase
 - Maximum redundancy use: 300 kA per phase
-
- SPD Specification
 - Surge Current Rating Per Phase

| Per Phase | L-N | L-G | N-G |
|-----------|--------|-------|-------|
| 100kA | 50kA | 50kA | 50kA |
| 150 kA | 100 kA | 50 kA | 50 kA |
| 200kA | 100kA | 100kA | 100kA |
| 250kA | 150kA | 100kA | 100kA |
| 300kA | 150kA | 150kA | 150kA |

 - 100% monitoring (Every MOV is monitored, incl. N-G)
 - EMI/RFI filtering: Active tracking up to -50 db from 10 kHz to 100 MHz
 - Repetitive impulse: 5,000 hits
 - Less than ½ nanosecond response time
 - Relative humidity range: 1-95% non-condensing
 - Operating frequency: 47-63 Hz
 - Operating temperature: -25°C (-15°F) to +60°C (140°F)



UL 1449 3rd Edition SPD

SIEMENS

- SPD Features
 - UL 1449 3rd Edition effective September 2009
 - Designed, manufactured & tested consistent with:
 - ANSI/IEEE C62.41.1-2002, C62.41.2-2002, and C62.45-2002
 - 1992/2000 NEMA LS-1
 - NEC Article 285
 - IEC 61643, CE
 - Large block, individually fused, thermally protected, 50 kA MOVs

- SPD Features
 - Direct bus connected
 - Can be wired to a circuit breaker (consult factory at time of order or see installation manual for retrofit)
 - 10 year warranty
- Standard Monitoring
 - LED indicators
 - Audible alarm with silence switch and test button
 - Dry contacts
- Available Options
 - Surge counter
 - Terminal lug for circuit breaker connection

- Key Bid Specifications
 - UL 1449 3rd Edition Recognized
 - UL 1283
 - Audible alarm with silence switch and test button
 - Dry contacts
 - EMI/RFI filtering
 - Protection modes on L-N, L-G, L-L, N-G
 - I_n Rating - 20 kA
 - Short Circuit Current Rating - 200 kA
 - Surge Current Rating
 - Per Phase = L-N + L-G
 - 100 kA 50 kA 50 kA

Ordering Information

Catalog #

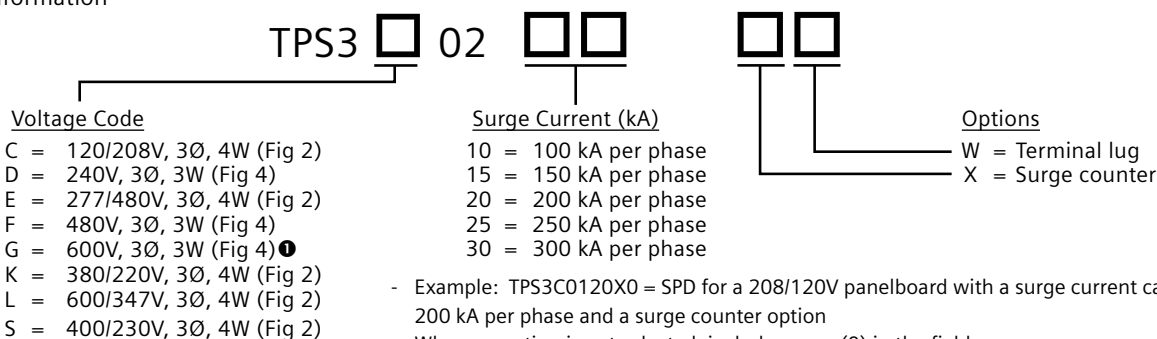

- Example: TPS3C0120X0 = SPD for a 208/120V panelboard with a surge current capacity of 200 kA per phase and a surge counter option
- When an option is not selected, include a zero (0) in the field
- Available Accessories: Ordered Separately
- RMSIE - Remote monitor

| UL 1449 3rd Edition - 2009 Test Data Summary | | | | | | | | | |
|--|--------------------------|------------|------------|------|-------------|--------|----------------|--------|-----------|
| Voltage Protection Rating (VPR - 6kV, 3kA) | | | | | | | | | |
| Voltage Code | Service Voltage | L-N | L-G | N-G | L-L | Type | I _n | SCCR | MCOV |
| A | 120/240V, 1Ø, 3W (Fig 1) | 700 | 700 | 700 | 1200 | Type 4 | 20 kA | 100 kA | 150 |
| B | 120/240V, 3Ø, 4W (Fig 3) | 700 / 1200 | 700 / 1200 | 700 | 1800 / 1800 | Type 4 | 20 kA | 200 kA | 150 / 320 |
| C | 120/208V, 3Ø, 4W (Fig 2) | 700 | 700 | 700 | 1200 | Type 4 | 20 kA | 200 kA | 150 |
| D | 240V, 3Ø, 3W (Fig 4) | | 1200 | | 1200 | Type 4 | 10 kA | 200 kA | 320 |
| E | 277/480V, 3Ø, 4W (Fig 2) | 1200 | 1200 | 1200 | 2000 | Type 4 | 20 kA | 200 kA | 320 |
| F | 480V, 3Ø, 3W (Fig 4) | | 1800 | | 1800 | Type 4 | 10 kA | 200 kA | 550 |
| G | 600V, 3Ø, 3W (Fig 4) | | 2500 | | 2500 | Type 4 | 10 kA | 200 kA | 690 |
| K | 380/220V, 3Ø, 4W (Fig 2) | 1200 | 1200 | 1200 | 2000 | Type 4 | 20 kA | 200 kA | 320 |
| L | 600/347V, 3Ø, 4W (Fig 2) | 1500 | 1500 | 1500 | 2500 | Type 4 | 10 kA | 200 kA | 420 |
| S | 400/230V, 3Ø, 4W (Fig 2) | 1200 | 1200 | 1200 | 2000 | Type 4 | 20 kA | 200 kA | 320 |

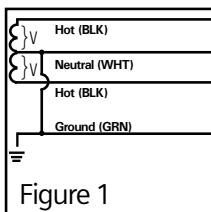

Split
2 Hots, 1 Neu, 1 Grnd

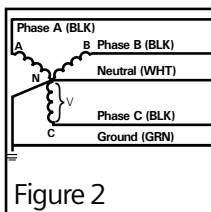

Wye
3 Hots, 1 Neu, 1 Grnd

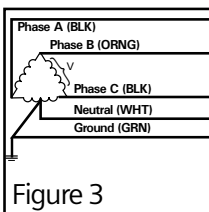

Hi-Leg Delta (B High)
3 Hots, (B High),
1 Neu, 1 Grnd

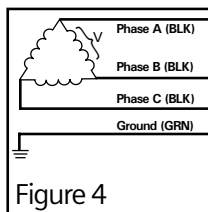

Delta & HRG Wye
3 Hots, 1 Grnd

Siemens Canada Limited
1577 North Service Road East
Oakville, ON L6H 0H6

SPD Hotline: 888.333.3545
info@purgethesurge.com

©2013 Siemens Canada Limited, Inc.
All Rights Reserved. Siemens is a registered trademark of Siemens AG. Product names mentioned may be trademarks or registered trademarks of their respective companies. Specifications are subject to change without notice.

www.siemens.ca/surge
www.siemens.ca

Notes:

- ❶ Available 100 kA & 150 kA only

TPS3 L2

True 10 Mode Protection

Surge Protection Device (SPD)

for Revised P1 Lighting Distribution Panelboards

Features:

- Mounts internal to:
 - Revised P1 Lighting Panelboards
- Consult factory for field retrofit in Revised P1 Lighting Panelboards
- UL 1449 3rd Edition Recognized
- UL 1283
- Type 4 SPD intended for use in Type 1 applications (Type 2, cUL)
- UL Type 1 tested with all internal OCP and safety coordination features included
- Large block, individually fused, thermally protected, 50 kA MOVs
- 20 kA I_n (most models)
- 200 kA SCCR (most models)
- UL96A Lightning Protection Master Label appropriate (@ 20 kA I_n)

- Applications
 - Provides main service or downstream protection for sensitive computer and electronic loads
 - Standard redundancy use: 150 kA per phase
 - Maximum redundancy use: 300 kA per phase

- SPD Specifications
 - Directly connected discrete protection elements between all possible modes providing true 10 mode protection
 - Surge Current Rating Per Phase

| Per Phase | L-N | L-G | L-L | N-G |
|-----------|--------|--------|--------|--------|
| 150 kA | 50 kA | 50 kA | 50 kA | 50 kA |
| 300 kA | 100 kA | 100 kA | 100 kA | 100 kA |
 - 100% monitoring (Every MOV is monitored, incl. N-G)
 - EMI/RFI filtering: Active tracking up to -50 db from 10 kHz to 100 MHz
 - Repetitive impulse: 5,000 hits
 - Less than 1/2 nanosecond response time
 - Relative humidity range: 1-95% non-condensing
 - Operating frequency: 47-63 Hz
 - Operating temperature: -25°C (-15°F) to +60°C (140°F)



UL 1449 3rd Edition SPD

SIEMENS

- SPD Features
 - UL 1449 3rd Edition effective September 2009
 - Designed, manufactured & tested consistent with:
 - ANSI/IEEE C62.41.1-2002, C62.41.2-2002, and C62.45-2002
 - 1992/2000 NEMA LS-1
 - NEC Article 285
 - IEC 61643, CE
 - Large block, individually fused, thermally protected, 50 kA MOVs
- SPD Features
 - Direct bus connected
 - Can be wired to a circuit breaker (consult factory at time of order or see installation manual for retrofit)
 - 10 year warranty
- Standard Monitoring
 - LED indicators
 - Audible alarm with silence switch and test button
 - Dry contacts
- Available Options
 - Surge counter
 - Terminal lug for circuit breaker connection
- Key Bid Specifications
 - UL 1449 3rd Edition Recognized - 2009
 - UL 1283
 - Audible alarm with silence switch and test button
 - Dry contacts
 - EMI/RFI filtering
 - Protection modes on L-N, L-G, L-L, N-G
 - I_n Rating - 20 kA
 - Short Circuit Current Rating - 200 kA
 - Surge Current Rating
 - Per Phase = L-N + L-G + L-L
 - 150 kA 50 kA 50 kA 50 kA

Ordering Information

Catalog #

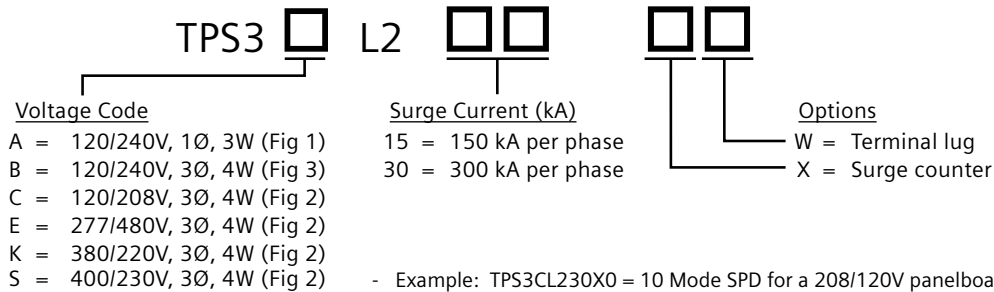

- Example: TPS3CL230X0 = 10 Mode SPD for a 208/120V panelboard with a surge current capacity of 300 kA per phase and a surge counter option
 - When surge counter is not selected, include a zero (0) in the field
- Available Accessories: Ordered Separately
- RMSIE - Remote monitor

| UL 1449 3rd Edition - 2009 Test Data Summary | | | | | | | | | |
|--|--------------------------|------------|------------|------|-------------|--------|-------|--------|-----------|
| Voltage Protection Rating (VPR - 6kV, 3 kA) | | | | | | | | | |
| Voltage Code | Service Voltage | L-N | L-G | N-G | L-L | Type | I_n | SCCR | MCOV |
| A | 120/240V, 1Ø, 3W (Fig 1) | 700 | 700 | 700 | 1000 | Type 4 | 20 kA | 100 kA | 150 |
| B | 120/240V, 3Ø, 4W (Fig 3) | 800 / 1500 | 700 / 1200 | 700 | 1800 / 1800 | Type 4 | 20 kA | 200 kA | 150 / 320 |
| C | 120/208V, 3Ø, 4W (Fig 2) | 700 | 700 | 700 | 1000 | Type 4 | 20 kA | 200 kA | 150 |
| E | 277/480V, 3Ø, 4W (Fig 2) | 1200 | 1200 | 1200 | 1800 | Type 4 | 20 kA | 200 kA | 320 |
| K | 380/220V, 3Ø, 4W (Fig 2) | 1200 | 1200 | 1200 | 1800 | Type 4 | 20 kA | 200 kA | 320 |
| S | 400/230V, 3Ø, 4W (Fig 2) | 1200 | 1200 | 1200 | 1800 | Type 4 | 20 kA | 200 kA | 320 |

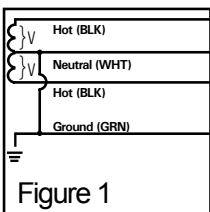

Figure 1
Split
2 Hots, 1 Neu, 1 Grnd

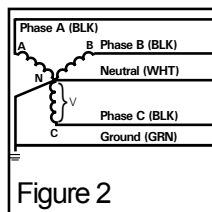

Figure 2
Wye
3 Hots, 1 Neu, 1 Grnd

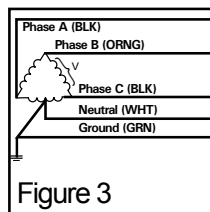

Figure 3
Hi-Leg Delta (B High)
3 Hots, (B High),
1 Neu, 1 Grnd

Siemens Canada Limited
1577 North Service Road East
Oakville, ON L6H 0H6

SPD Hotline: 888.333.3545
info@purgethesurge.com

©2013 Siemens Canada Limited, Inc.
All Rights Reserved. Siemens is a registered trademark of Siemens AG. Product names mentioned may be trademarks or registered trademarks of their respective companies. Specifications are subject to change without notice.

www.siemens.ca/surge
www.siemens.ca

TPS3 09

Type 1 Surge Protective Device (SPD) Mounts External to Electrical Distribution Equipment or Internal to P1, P2 Lighting Panelboards, P3 Power Panelboards and Busway Systems

Features:

- UL 1449 3rd Edition – 2009, cUL
- Type 1 SPD (Type 2 cUL)
- Mounts external to electrical distribution equipment
- Weatherproof hub included
- Mounts internal to P1 panelboards & busway
 - P1 - Field retrofit or factory install
 - P2 and P3 - Factory install only
 - Consult factory for field retrofit
- Large block, individually fused, thermally protected, 50 kA MOVs
- 20 kA In (most models)
- 200 kA SCCR (most models)
- All UL-required OCP & safety coordination included
- UL96A Lightning Protection Master Label compliant (@ 20 kA In)
- SPD Specifications
 - Surge Current Rating Per Phase

| Per Phase | L-N | L-G | N-G |
|-----------|-------|-------|-------|
| 100 kA | 50 kA | 50 kA | 50 kA |

- 100% monitoring (Every MOV is monitored, incl. N-G)
- Individually fused and thermally protected MOVs
- Solid state bi-directional operation
- Repetitive impulse: 5,000 hits
- Less than 1 nanosecond response time
- Relative humidity range: 0 -95% non-condensing
- Operating frequency: 47-63 Hz
- Operating temperature: -25°C (-15°F) to +60°C (140°F)
- Standard Configuration
 - Standard NEMA 4X polycarbonate enclosure (UL 746C (f1), UL 94-5VA)
 - Wire size: Prewired with 3' (91.4cm) of #10 AWG
 - Standard size: 8" x 3" x 3" (203 mm x 76 mm x 76 mm)
 - Standard weight: 3 lbs. (1.4 kg)



TPS3 09

- SPD Features
 - UL 1449 3rd Edition effective September 2009
 - Designed, manufactured and tested consistent with:
 - ANSI/IEEE C62.41.1-2002, C62.41.2-2002, and C62.45-2002
 - 1992/2000 NEMA LS-1
 - NEC Article 285
 - IEC 61643, CE
 - Large block, individually fused, thermally protected, 50 kA MOVs
 - 10 year warranty
- SPD Monitoring
 - LED indicators
- Available Options
 - Dry contacts & audible alarm
- Available Accessories
 - RMSIE = Remote monitor
 - FMKITC = Flush mount plate
 - TPS9IKITP1 = Mounting bracket for installation in original P1 panels
 - TPS9IKITP1A = Mounting bracket for installation in Next Gen P1 panels
 - TPS9IKITP2 = Mounting bracket for installation in P2 panels
- Key Bid Specifications
 - UL 1449 3rd Edition Recognized - 2009, cUL
 - Type 2 SPD^①
 - Protection modes on L-N, L-G, L-L, N-G
 - I_n Rating - 20 kA
 - Short Circuit Current Rating - 200 kA
 - Surge Current Rating

| | | | | | | |
|-----------|---|------|---|------|---|--|
| Per Phase | = | L-N | + | L-G | + | |
| 150kA | | 50kA | | 50kA | | |

Ordering Information

Catalogue # **TPS3** **09** **2**

Voltage Code

A = 120/240V, 1Ø, 3W (Fig 1)
 B = 120/240V, 3Ø, 4W (Fig 3)
 C = 120/208V, 3Ø, 4W (Fig 2)
 D = 240V, 3Ø, 3W (Fig 4)
 E = 277/480V, 3Ø, 4W (Fig 2)
 F = 480V, 3Ø, 3W (Fig 4)
 G = 600V, 3Ø, 3W, (Fig 4)
 K = 380/220V, 3Ø, 4W (Fig 2)
 L = 600/347V, 3Ø, 4W (Fig 2)
 S = 400/230V, 3Ø, 4W (Fig 2)

Surge Current (kA)

10 = 100 kA per phase

Options

E = Extended indicator light
 I = Internal mounting in P1, P2 panels^②
 D = Dry contact & audible alarm

- Example: TPS3C0910D002 = Type 2 SPD for a 208/120V panelboard with a surge current capacity of 100 kA per phase with standard NEMA 4X enclosure, dry contacts and audible alarm option.

- Available for field retrofit in P1 panels

- When an option is not selected, include a zero (0) in the field

| UL 1449 3rd Edition - 2009 Test Data Summary | | | | | | | | | |
|--|--------------------------|------------|------------|------|------------|-------------------|----------------|--------|-----------|
| Voltage Protection Rating (VPR - 6kV, 3 kA) | | | | | | | | | |
| Voltage Code | Service Voltage | L-N | L-G | N-G | L-L | Type ^① | I _n | SCCR | MCOV |
| A | 120/240V, 1Ø, 3W (Fig 1) | 600 | 700 | 500 | 1000 | Type 2 | 20 kA | 100 kA | 150 |
| B | 120/240V, 3Ø, 4W (Fig 3) | 600 / 1200 | 700 / 1200 | 500 | 1000/ 1000 | Type 2 | 20 kA | 200 kA | 150 / 320 |
| C | 120/208V, 3Ø, 4W (Fig 2) | 600 | 700 | 500 | 1000 | Type 2 | 20 kA | 200 kA | 150 |
| D | 240V, 3Ø, 3W (Fig 4) | | 1200 | | 1200 | Type 2 | 20 kA | 200 kA | 320 |
| E | 277/480V, 3Ø, 4W (Fig 2) | 1200 | 1200 | 1000 | 1800 | Type 2 | 20 kA | 200 kA | 320 |
| F | 480V, 3Ø, 3W (Fig 4) | | 1800 | | 1800 | Type 2 | 10 kA | 200 kA | 552 |
| G | 600V, 3Ø, 3W (Fig 4) | | 2500 | | 2500 | Type 2 | 10 kA | 200 kA | 690 |
| K | 380/220V, 3Ø, 4W (Fig 2) | 1200 | 1200 | 1000 | 1800 | Type 2 | 20 kA | 200 kA | 320 |
| L | 600/347V, 3Ø, 4W (Fig 2) | 1500 | 1500 | 1500 | 2500 | Type 2 | 10 kA | 200 kA | 420 |
| S | 400/230V, 3Ø, 4W (Fig 2) | 1200 | 1200 | 1000 | 1800 | Type 2 | 20 kA | 200 kA | 320 |

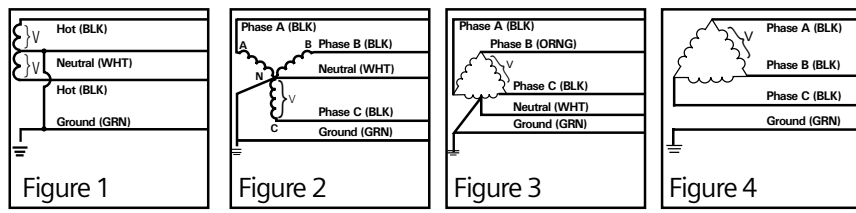

- Notes:
- ① Type 1 UL
 - ② Requires TPS9IKITP1 or TPS9IKITP2 mounting bracket accessory, see available Accessories

The information provided in this brochure contains merely general descriptions or characteristics of performance which in case of actual use do not always apply as described or which may change as a result of further development of the products. An obligation to provide the respective characteristics shall only exist if expressly agreed in the terms of contract.

All product designations may be trademarks or product names of Siemens AG or supplier companies whose use by third parties for their own purposes could violate the rights of the owners.

Subject to change without prior notice

Order No.: EM-LP-1343
All rights reserved
Printed in Canada
© 2015 Siemens Canada Limited

Siemens Canada Limited
Low Voltage & Products
Energy Management Division
1577 North Service Road East
Oakville, Ontario L6H 0H6

Customer Interaction Centre
(888) 303-3353
cic.ca@siemens.com

siemens.ca/panelboards