

HPC™ High-Pressure Contact Switch

- Overview.....9-2
- HPC™ Switch, New Generation, Nomenclature System.....9-6
- Frame Product Number Nomenclature.....9-8
- EntelliGuard™ Control Unit Nomenclature.....9-10
- Application Information, Outlines and Dimensions.....9-11
- How to Order.....9-13
- Accessories.....9-14
- Reference Publications.....9-22

Premium Duty QMW, Heavy Duty QMR

- Individual Components.....9-23
- Factory Assembled Fuse Clips.....9-25

Handle Operators

- Product Ordering Tables.....9-28
- Accessories and Modifications.....9-29

General-Duty HCI

- Individual Components.....9-31

TDR Handle Mechanism

- Handle Operating Mechanisms.....9-33

FD1 Fusible IEC Style

- Individual Components.....9-34
- Accessories.....9-35
- Outlines and Dimensions.....9-37

DILOS Nonfusible Vu-Break IEC Style

- Individual Components.....9-38
- Accessories.....9-39
- Outlines and Dimensions.....9-40



Disconnect Switches and Operating Mechanisms Section 9

HPC™, New Generation High-Pressure Contact Switch

Top- or Bottom Feed

800-4000 Amperes - 600 Vac Max.

Product Introduction

GE type HPC™ switches are UL listed in accordance with Standard 977, Fused Power Circuit Devices (UL File No. E-51827). The charge-after-close mechanism provides stored energy, quick-make/quick-break operation. Multiple spring-loaded high-pressure current-carrying contact arms and an arcing contact arm provide excellent current-carrying capability without sacrificing high interrupting fault performance. These switches are 100 percent rated and can interrupt, on a make and break basis, a minimum of 12 times their nameplate rating without fuse assistance at 600Vac. Complete HPC™ switch and Class L fuse coordination is therefore achieved for all levels of fault current up to 200,000 rms amperes symmetrical at 600Vac maximum. Type HPC™ switches used as service disconnects comply with the National Electrical Code Article 110.10 for adequate short-circuit current and ground fault protection.

Greater Convenience and Operational Safety

The controls and status indicators you need most are readily accessible. The flush-mounted handle, ON/OFF buttons, test receptacle, bell alarm reset buttons — with or without lockout — are easily reached and all are double-insulated from live components. And, for added security, a standard padlock device lets you prevent accidental or unauthorized closing of the switch.

HPC™ switches, new generation are versatile and designed for a wide variety of applications including temperature insensitive control units, push-to-open and close control, charge-after-close operation, 3 cycle closing, UL listed (file E-51827) field installable accessories suitable for 50/60 Hz. All accessories and control wiring are prewired to dedicated, secondary terminal points on each switch.

Features

—High Durability—Safety of Operation

High-dielectric strength, glass reinforced insulated case.

—High Interrupting Capability

Arc chute of unique construction suppresses arcs and cools gases rapidly, providing quick arc interruption and extended switch life.

—High Transient Voltage Withstandability

Interphase partitions mesh with switch midcover to completely isolate each pole.

—Extended Switch Life

Preloaded constant pressure pivot eliminates braid whip and fraying on high short circuit currents and repeated operations.

—Positive “ON-OFF” Indication

Green (OFF), Red (ON), provides visual indication regarding the position of the switch contacts.

—Easy Operation—Quick Make

Flush-mounted handle, operated 6 times to charge; push button on remote close to close the switch

—Emergency Open—Quick Break

Finger-tip “OFF” button rapidly opens the switch contacts.

—Fuse Mounting Bolts for Ease of Mounting Fuses

—Padlocking Provisions Standard

Product Forms

—**Top Feed**—Line terminals at top of switch.



1600A HPC™ Switch (Type SHP, Top-Feed)

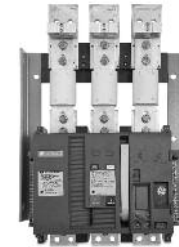

1600A HPC™ Switch (Type SHP, Bottom-Feed)

—**Bottom Feed**—Line terminals at bottom of switch; fuses are de-energized when switch is in OFF positions. Same size as top-feed.

Quick, Error-Free Installation of Universal Accessories

Drop-in bell alarm, bell alarm with manual reset lockout, shunt trip, shunt trip with lockout, and undervoltage release install in seconds. No special tools. No switch disassembly. Just slide them into place. The modules are universal across all frame sizes and each is mechanically keyed to its compartment so you make the right connection, every time. These accessories are field installable and upgradable.

GE's innovative, modular, drop-in accessories provide the ultimate customer solution for field customization:

UL Listed

- Accessory combination (one each) shunt trip, shunt trip with lockout, undervoltage release, bell alarm (alarm only), bell alarm with lockout.
- Rated 12-250 Vdc through 12-240 Vac, continuous duty.

Complete installation in seconds without special tools, switch disassembly or adjustment

- The user can select how protective control unit functions, the shunt trip (with or without lockout), and UVR accessories interface with the bell alarm and bell alarm with lockout accessories: An overcurrent, shunt trip, or UVR trip can be set to actuate the bell alarm or bell alarm with lockout. Any combination of output actions based on inputs can be selected.
- Shunt trip and undervoltage trip targets are clearly displayed by the control unit LCD.

Pre-wired wire harness makes field installation a snap for:

- Motor operator with remote charge indicator
- Form C auxiliary switches, up to 12-stage maximum
- Remote close solenoid

Additional field-installable accessories including:

- Key interlock provision (4 locks maximum)
- Limited access ON/OFF cover
- Mechanical operations counter
- Door interlock



Disconnect Switches and Operating Mechanisms

HPC™ High-Pressure Contact Switch

Top- or Bottom-Feed
800-4000 Amperes - 600 Vac Max.

HPC™ Switches with Electric Trip

For use with Ground Break™ components or for remote tripping. Fuses not included.
For resistance-grounded systems or where zone selective interlocking is required, electric trip HPC™ switches with Ground Break™ system components are recommended.

Source Configuration	Ampere Rating	Control Voltage	Net Weight, Lbs. (Approx.)	Product Number
Top Feed	800A	120-240Vac	75	THPR3608ET1
Top Feed	1200A	120-240Vac	80	THPR3612ET1
Top Feed	1600A	120-240Vac	80	THPR3616ET1
Top Feed	2000A	120-240Vac	165	THPC3620ET1
Top Feed	2500A	120-240Vac	180	THPC3625ET1
Top Feed	3000A	120-240Vac	180	THPC3630ET1
Top Feed	4000A	120-240Vac	505	THPC3640ET1
Top Feed	800A	480-600Vac	75	THPR3608ET2
Top Feed	1200A	480-600Vac	80	THPR3612ET2
Top Feed	1600A	480-600Vac	80	THPR3616ET2
Top Feed	2000A	480-600Vac	165	THPC3620ET2
Top Feed	2500A	480-600Vac	180	THPC3625ET2
Top Feed	3000A	480-600Vac	180	THPC3630ET2
Top Feed	4000A	480-600Vac	505	THPC3640ET2
Bottom Feed	800A	120-240Vac	75	THPR3608BET1
Bottom Feed	1200A	120-240Vac	80	THPR3612BET1
Bottom Feed	1600A	120-240Vac	80	THPR3616BET1
Bottom Feed	2000A	120-240Vac	165	THPC3620BET1
Bottom Feed	2500A	120-240Vac	180	THPC3625BET1
Bottom Feed	3000A	120-240Vac	180	THPC3630BET1
Bottom Feed	4000A	120-240Vac	505	THPC3640BET1
Bottom Feed	800A	480-600Vac	75	THPR3608BET2
Bottom Feed	1200A	480-600Vac	80	THPR3612BET2
Bottom Feed	1600A	480-600Vac	80	THPR3616BET2
Bottom Feed	2000A	480-600Vac	165	THPC3620BET2
Bottom Feed	2500A	480-600Vac	180	THPC3625BET2
Bottom Feed	3000A	480-600Vac	180	THPC3630BET2
Bottom Feed	4000A	480-600Vac	505	THPC3640BET2



Type THPR, 800-1600A HPC™ Switch, Top Feed

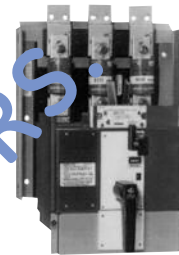

Type THPR, 800-1600A HPC™ Switch, Bottom Feed

Manual HPC™ Switches

For service or feeder disconnects not requiring ground fault protection. Includes fuse-mounting hardware and door-catch interlock bracket. Fuses not included.

Source Configuration	Ampere Rating	Net Weight Lbs. (Approx.)	Product Number
Top Feed	800A	75	THPR3608
Top Feed	1200A	80	THPR3612
Top Feed	1600A	80	THPR3616
Top Feed	2000A	165	THPC3620
Top Feed	2500A	180	THPC3625
Top Feed	3000A	180	THPC3630
Top Feed	4000A	505	THPC3640
Bottom Feed	800A	75	THPR3608B
Bottom Feed	1200A	80	THPR3612B
Bottom Feed	1600A	80	THPR3616B
Bottom Feed	2000A	165	THPC3620B
Bottom Feed	2500A	180	THPC3625B
Bottom Feed	3000A	180	THPC3630B
Bottom Feed	4000A	505	THPC3640B

NOTE: OBSOLETE. SEE PAGE 9-6 FOR NEW HPC™ PRODUCT NUMBERS.



Disconnect Switches and Operating Mechanisms

HPC™ High-Pressure Contact Switch

Section 9

With Integral Ground Fault Devices
 800-4000 Amperes - 600 Vac Max.
 UL File. No. E-51827

HPC™ Switches with Integral Ground Fault Protection for Solidly Grounded Systems

Integral Ground Fault with 3-Phase Sensor, Adjustable Pick-up, Adjustable Time-Delay, Test Function, and Mechanical Ground Fault Indicator

Source Configuration	Ampere Rating	Net Weight Lbs. (Approx.)	Product Number
Top Feed	800A	105	THPR3608G3T
Top Feed	1200A	105	THPR3612G3T
Top Feed	1600A	105	THPR3616G3T
Top Feed	2000A	195	THPC3620G3T
Top Feed	2500A	210	THPC3625G3T
Top Feed	3000A	210	THPC3630G3T
Top Feed	4000A	540	THPC3640G3T
Bottom Feed	800A	105	THPR3608BG3T
Bottom Feed	1200A	105	THPR3612BG3T
Bottom Feed	1600A	105	THPR3616BG3T
Bottom Feed	2000A	195	THPC3620BG3T
Bottom Feed	2500A	210	THPC3625BG3T
Bottom Feed	3000A	210	THPC3630BG3T
Bottom Feed	4000A	540	THPC3640BG3T



HPC™ Switches with Integral Ground Fault Protection

HPC™ Switches with Integral Ground Fault Alarm only for Solidly Grounded Systems

Integral Ground Fault with 3-Phase Sensor, Adjustable Pick-up, Adjustable Time-Delay, Test Function, and Mechanical Ground Fault Indicator

Source Configuration	Ampere Rating	Net Weight Lbs. (Approx.)	Product Number
Top Feed	800A	105	THPR3608GA3
Top Feed	1200A	105	THPR3612GA3
Top Feed	1600A	105	THPR3616GA3
Top Feed	2000A	195	THPC3620GA3
Top Feed	2500A	210	THPC3625GA3
Top Feed	3000A	210	THPC3630GA3
Top Feed	4000A	540	THPC3640GA3
Bottom Feed	800A	105	THPR3608BGA3
Bottom Feed	1200A	105	THPR3612BGA3
Bottom Feed	1600A	105	THPR3616BGA3
Bottom Feed	2000A	195	THPC3620BGA3
Bottom Feed	2500A	210	THPC3625BGA3
Bottom Feed	3000A	210	THPC3630BGA3
Bottom Feed	4000A	540	THPC3640BGA3

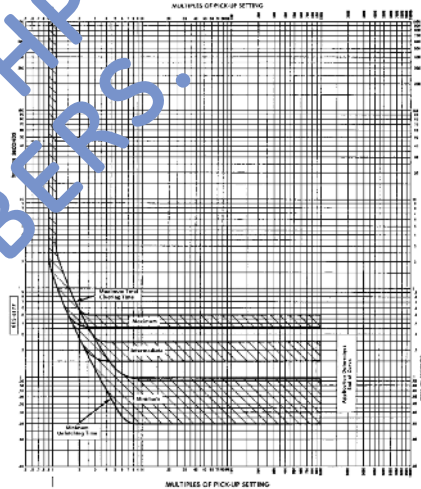

Integral Ground Fault HPC™ Pick-up and Delay Time-current Curves

Includes fuse-mounting hardware and door-catch interlock bracket. (Fuses not included.)

NOTE: The 800-3000 ampere integral ground fault HPC™ switches can easily be installed in the space occupied by a manual HPC™ switch of the same ampere rating. The 4000 ampere switch, being 3 inches wider, may require some modification.

NOTE: Integral ground fault tripping is accomplished by a low energy, flux-shifting tripping mechanism and is not suitable for remote (parallel) tripping. If remote tripping is required, add suffix RT1 120-240Vac or RT2 480-600Vac to above product number.

NOTE: OBSOLETE - SEE PAGE 9-6 FOR NEW HPC™ PRODUCT NUMBERS.

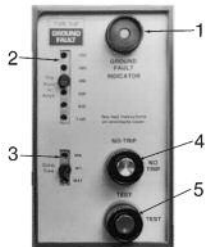

- Mechanical Indicator** – protrudes when ground fault occurs.
- Field Adjustable Ground Fault Trip Point** – from 200 to 1100 amperes in six steps.
- Field Adjustable Ground Fault Delay Time** – min. (0.03 sec.) intermediate (0.20 sec.) and max. (0.50 sec.) delay time settings.
- No Trip Test Button** – permits ground fault system check without tripping switch.
- Test Button** – simulates an actual ground fault and will trip switch off unless "No Trip" button is depressed prior to pushing test button. Ground fault indicator will protrude when system is tested or when actual ground fault occurs.

Note: Although the integral ground fault function is self-powered, the test function does require an external 120Vac (200 volt amperes nominal) control power source.



HPC™ High-Pressure Contact Switch (continued)

With Integral Ground Fault Devices

800-4000 Amperes

600 Vac Max.

UL File. No. E-51827

Neutral Current (800: 1 ratio) Sensors

Inside Dimensions	Core Construction	Thermal Rating (Amperes)	Weight (Lbs.)	Product Number
2.5" Dia.	Solid	1600	3	TGS0002
5" Dia.	Solid	2500	4	TGS0005
8" Dia.	Solid	3000	7	TGS0008
4" x 8"	Split	4000	15	TGS0408
8" x 8"	Split	4000	25	TGS0808



Neutral Current Sensor - Solid



Neutral Current Sensor - Split

NOTE: REPLACEMENT PARTS ONLY, USED FOR ORIGINAL HPC™ SWITCHES MANUFACTURED PRIOR TO 2014. SEE PAGE 9-21 FOR NEW INSTALLATIONS.



Disconnect Switches and Operating Mechanisms

HPC™, New Generation High-Pressure Contact Switch

HPC™ Switch, New Generation, Nomenclature System

Section 9

HPC™ Switch, New Generation, Nomenclature

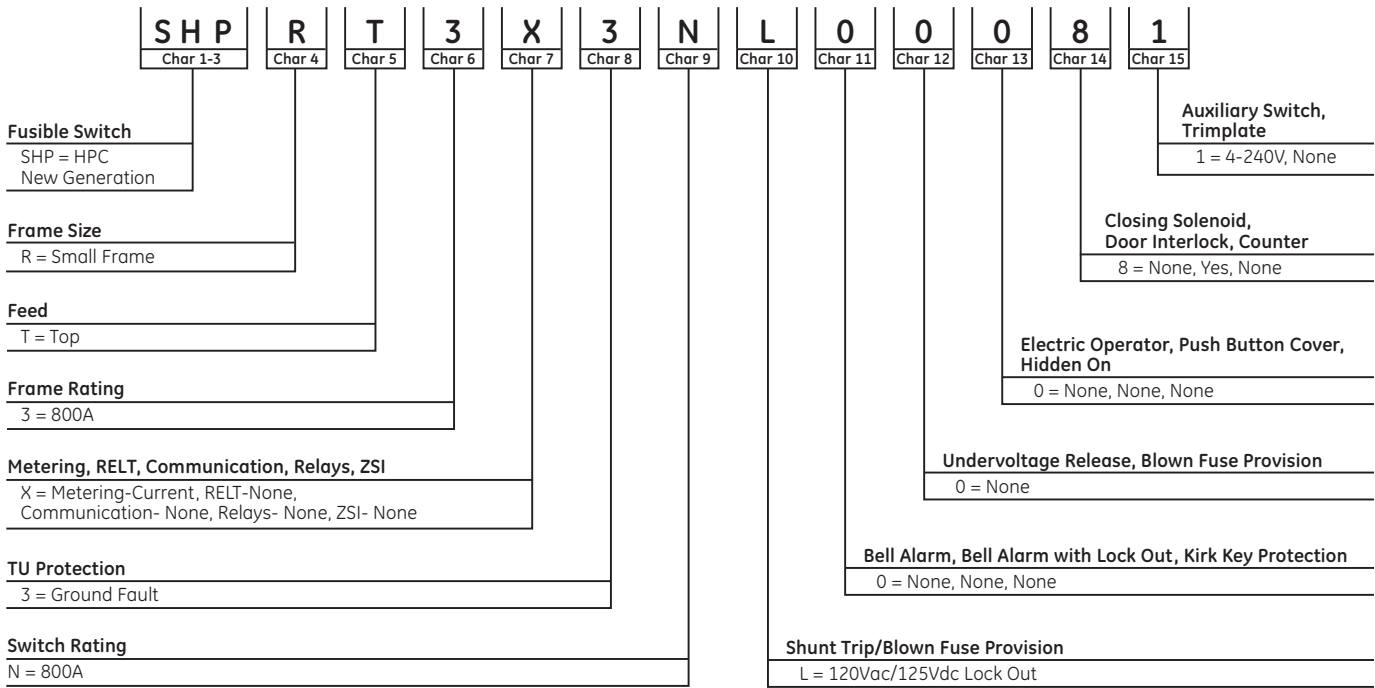

Characters 1, 2, 3 Fusible Switch

	Character 1, 2, 3
HPC™, New Generation	SHP

Characters 4 Frame Size

	Character 4
Small (800A - 1600A)	R
Large (2000A - 4000A)	C
Long (42" 4000A w/ GF, Retrofill only)	L

Character 5 Feed

	Character 5
Top	T
Bottom	B

Character 6 Frame Rating

	Character 6
800A	3
1600A	5
2000A	6
2500A	7
3000A	8
4000A	9

Character 7 Metering, RELT, Communication, Relays, ZSI

	Metering	RELT	Comm	Relays	ZSI	Character 7
Current	None	None	None	None	None	X
Current	RELT	None	None	None	None	A
Current	RELT	Modbus	None	None	None	B
Current	None	Modbus	None	None	None	C
Adv & WFC	RELT	Modbus	None	None	None	D
Adv & WFC	None	Modbus	None	None	None	E
Adv & WFC	RELT	Modbus	Yes	None	None	F
Adv & WFC	None	Modbus	Yes	None	None	G
Current	None	None	None	None	G	K
Current	RELT	None	None	None	G	L
Current	RELT	Modbus	Yes	G	G	M
Current	None	Modbus	Yes	G	G	N
Adv & WFC	RELT	Modbus	None	G	G	Q
Adv & WFC	None	Modbus	None	G	G	R
Adv & WFC	RELT	Modbus	Yes	G	G	W
Adv & WFC	None	Modbus	Yes	G	G	Y
Current	None	None	None	None	G&I	Z
Current	RELT	None	None	None	G&I	1
Current	RELT	Modbus	None	None	G&I	2
Current	None	Modbus	None	None	G	3
Adv & WFC	RELT	Modbus	None	None	G&I	5
Adv & WFC	None	Modbus	None	None	G	6
Adv & WFC	RELT	Modbus	Yes	G&I	G&I	8
Adv & WFC	None	Modbus	Yes	G	G	9



Disconnect Switches and Operating Mechanisms HPC™, New Generation High-Pressure Contact Switch

Section 9

HPC™ Switch, New Generation, Nomenclature System

Character 8 TU Protection

	Character 8
Fuse Only	X
I (Switchable)	1
IG (I Switchable)	8
IGA (I Switchable)	9
IGDA (All Switchable) ¹	A
G	3
GA	4
GDA (All Switchable) ¹	5

¹G switchable by password only

Character 9 Switch Rating

	Character 9
800A	N
1200A	R
1600A	U
2000A	W
2500A	1
3000A	2
4000A	5

Character 10 Shunt Trip/ Blown Fuse Provision

Voltage	with Lockout	without Lockout	Blown Fuse Provision	Character 10
None	•		None	0
12 Vdc	•		None	H
24 Vac/24 Vdc	•		None	J
48 Vac/48 Vdc	•		None	K
120 Vac/125 Vdc	•		None	L
208 Vac	•		None	M
240 Vac/250 Vdc	•		None	N
480 Vac	•		None	P
600 Vac	•		None	R
120 Vac	•		•	V
208 Vac	•		•	W
240 Vac	•		•	Y
12 Vdc		•	None	1
24 Vac/24 Vdc		•	None	2
48 Vac/48 Vdc		•	None	3
120 Vac/125 Vdc		•	None	4
208 Vac		•	None	5
240 Vac/250 Vdc		•	None	6
480 Vac		•	None	7
600 Vac		•	None	8
120 Vac		•	•	S
208 Vac		•	•	T
240 Vac		•	•	U

Character 11 Bell Alarm, Bell Alarm with Lock Out, Kirk Key Protection

Bell Alarm	Bell Alarm with Lock Out	Kirk Key Protection	Character 11
None	None	None	0
None	240	None	1
None	600	None	2
240	None	None	4
240	240	None	5
240	600	None	6
600	None	None	8
600	240	None	9
600	600	None	A
None	None	4	G
None	240	4	H
None	600	4	J
240	None	4	L

Character 11 Bell Alarm, Bell Alarm with Lock Out, Kirk Key Protection (Continued)

240	240	4	M
240	600	4	N
600	None	4	R
600	240	4	S
600	600	4	T

Character 12 Undervoltage Release, Blown Fuse Provision

Undervoltage Release	Blown Fuse Provision	Character 12
None	None	0
24 Vac	None	1
48 Vac	None	2
120 Vac	None	3
208 Vac	None	4
240 Vac	None	5
480 Vac	None	6
600 Vac	None	7
12 Vdc	None	8
24 Vdc	None	9
48 Vdc	None	A
125 Vdc	None	B
250 Vdc	None	C
120 Vac	•	W
208 Vac	•	X
240 Vac	•	Y

Character 13 Electric Operator, Push Button Cover, Hidden On

Electric Operator	Push Button Cover	Hidden On	Character 13
None	None	None	0
120 Vac	None	None	1
240 Vac	None	None	2
24 Vdc	None	None	3
48 Vdc	None	None	4
72 Vdc	None	None	5
125 Vdc	None	None	6
None	Yes	None	8
120 Vac	Yes	None	9
240 Vac	Yes	None	A
24 Vdc	Yes	None	B
48 Vdc	Yes	None	C
72 Vdc	Yes	None	D
125 Vdc	Yes	None	E
None	None	Yes	G
120 Vac	None	Yes	H
240 Vac	None	Yes	J
24 Vdc	None	Yes	K
48 Vdc	None	Yes	L
72 Vdc	None	Yes	M
125 Vdc	None	Yes	N
None	Yes	Yes	R
120 Vac	Yes	Yes	S
240 Vac	Yes	Yes	T
24 Vdc	Yes	Yes	U
48 Vdc	Yes	Yes	V
72 Vdc	Yes	Yes	W
125 Vdc	Yes	Yes	X



Disconnect Switches and Operating Mechanisms HPC™, New Generation High-Pressure Contact Switch

Section 9

HPC™ Switch, New Generation, Nomenclature System

Character 14 Closing Solenoid, Door Interlock, Counter

Closing Solenoid	Door Interlock	Counter	Character 14
None	Yes	None	8
120 Vac	Yes	None	9
240 Vac	Yes	None	A
24 Vdc	Yes	None	B
48 Vdc	Yes	None	C
72 Vdc	Yes	None	D
125 Vdc	Yes	None	E
None	Yes	Yes	R
120 Vac	Yes	Yes	S
240 Vac	Yes	Yes	T
24 Vdc	Yes	Yes	U
48 Vdc	Yes	Yes	V
72 Vdc	Yes	Yes	W
125 Vdc	Yes	Yes	X

Character 15 Auxiliary Switch, Trimplate

Auxiliary Switch	Trimplate	Character 15
None	None	0
4-240V	None	1
8-240V	None	2
12-240V	None	3
4-600V	None	4
8-600V	None	5
None	Yes	8
4-240V	Yes	9
8-240V	Yes	A
12-240V	Yes	B
4-600V	Yes	C
8-600V	Yes	D

HPC™ Switch, New Generation, Frame Product Numbers

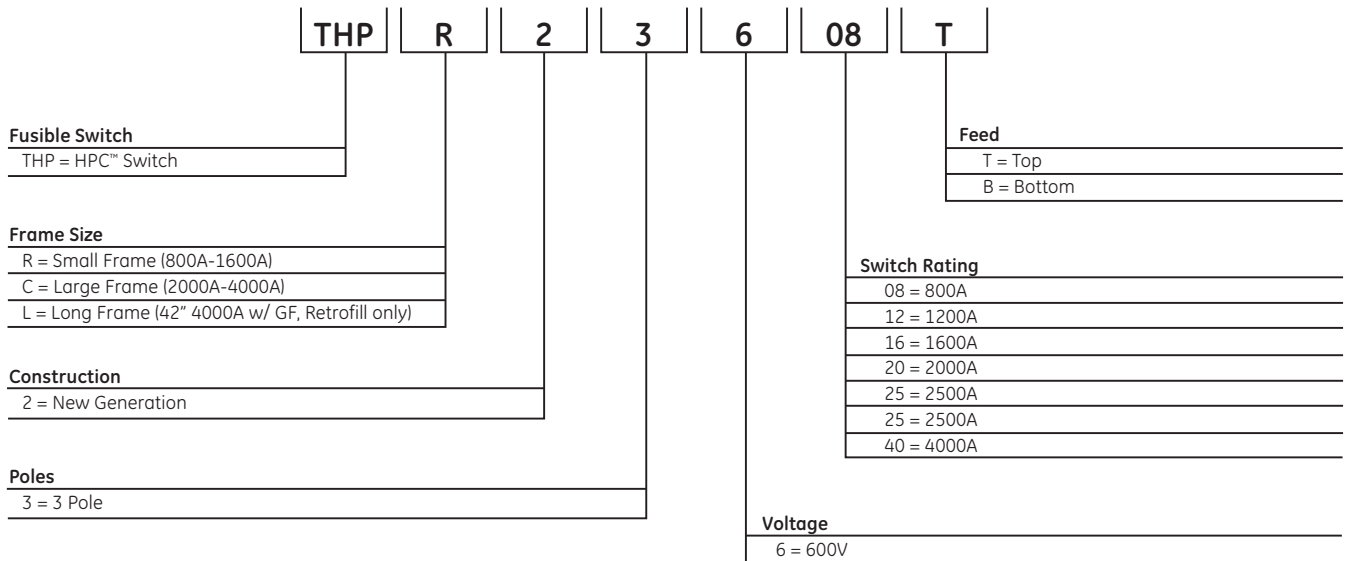

Disconnect Switches and Operating Mechanisms HPC™, New Generation High-Pressure Contact Switch

Product Number Nomenclature System

Accessory Product Numbers

HPC™ Switch		SP	AS	240	AB4	R	Extender	
Device Type								R = Field installable kit Blank = Factory installed
AS = Auxiliary switch ¹								
BAA = Bell alarm, alarm only ¹								
BAL = Bell alarm with lockout ¹								
COUNTER = Mechanical counter ¹								
DIL = Defeatable door interlock								
E = Electric operator ¹								
K4 = Kirk key lock (4 maximum) ¹								
PBCOVER = Pushbutton cover ¹								
RCS = Remote close solenoid ¹								
ST = Shunt trip								
STL = Shunt trip with lockout ¹								
UV = Undervoltage release								
								Auxiliary Switch Extender
								AB4 = Auxiliary switch, type AB with 4 elements
								AB8 = Auxiliary switch, type AB with 8 elements
								AB12 = Auxiliary switch, type AB with 12 elements
								Voltage, unless otherwise stated
								012 = 12 Vdc
								024 = 24 Vdc
								048 = 48 Vdc
								120/125 = 120 Vac or 125 Vdc
								240/250 = 240 Vac and 250 Vdc
								250 = 250 Vdc
								480 = 480 Vac
								600 = 600 Vac
								08 = 800 A 25 = 2500 A
								16 = 1600 A 30 = 3000 A
								20 = 2000 A 40 = 4000 A

¹Device Product Number requires an extender "R" for field installable kit version only.

NOTE: This information is provided only for use interpreting product numbers. It cannot be used to build product numbers.



Disconnect Switches and Operating Mechanisms HPC™, New Generation High-Pressure Contact Switch

Section 9

EntelliGuard™ Control Unit Nomenclature

EntelliGuard™ Control Unit Nomenclature

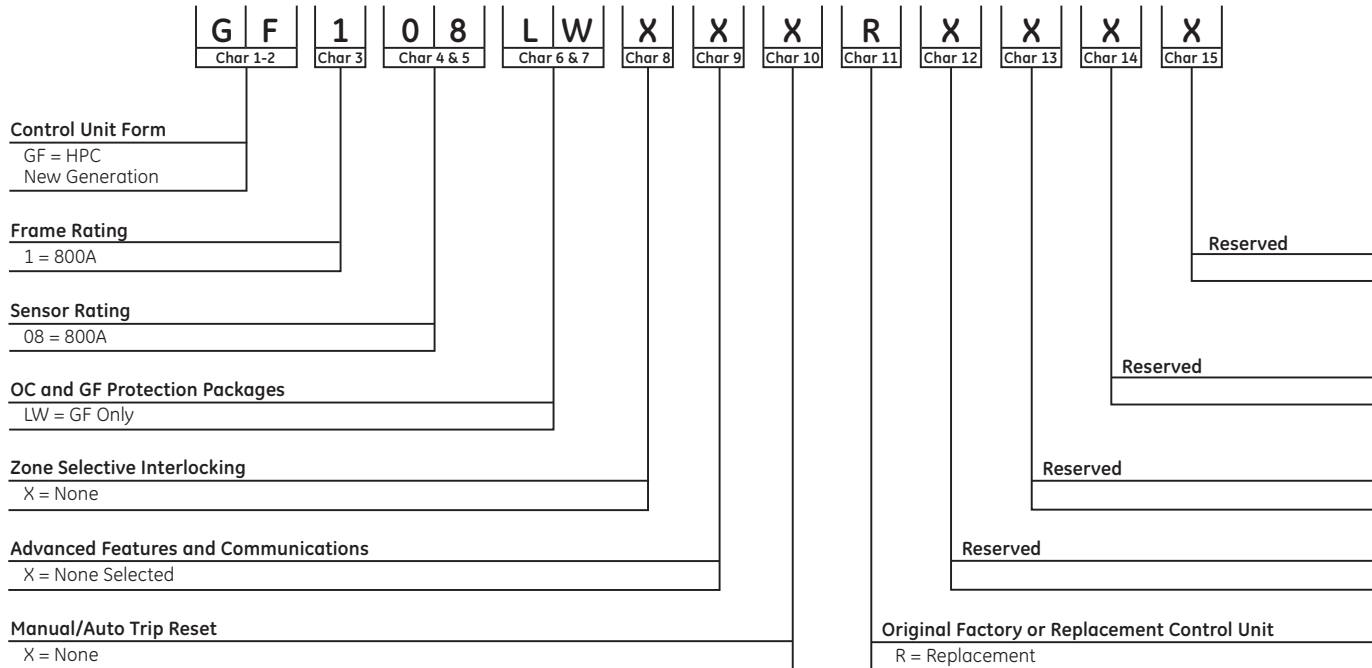

Character 1 & 2 EntelliGuard™ Control Unit Form

	Character 1 & 2
HPC™, New Generation	GF

Character 3 Frame Ratings

	Character 3
800A	1
1600A	2
2000A	3
2500A	4
3000A	5
4000A	7

Note: Use 1600A CT w/ 1200A rating plug for 1200A HPC™ frame.

Character 4 & 5 Sensor Rating (Amperes)

	Character 4 & 5
800A	08
1600A	16
2000A	20
2500A	25
3000A	30
4000A	40

Character 6 & 7 OC and GF Protection Packages

	Character 6 & 7
Fuse Only	LZ
I (Switchable)	S1
IG (I Switchable)	S2
IGA (I Switchable)	S3
IGDA (All Switchable) ¹	S4
GDA (All Switchable) ¹	S5
G	LW
GA	LY

¹G switchable by password only

Character 8 Zone Selective Interlocking

	Character 8
None	X
G user selectable	Z
Z+IOC user selectable	T

Character 9 Advanced Features and Communications

	Character 9
None Selected	X
RELT	1
RELT+Modbus	2
Modbus-Adv Meter+WFC+RELT	6
Modbus-Adv Meter+WFC+RELT+relay	8
Modbus Only (No RELT)	A
Adv Metering, Modbus (No RELT)	D
Adv Metering, Modbus, Relays (No RELT)	E

Character 10 Manual/Auto Trip Reset

	Character 10
None	X

Character 11 Original Factory or Replacement Control Unit

	Character 11
Factory	F
Replacement	R



Disconnect Switches and Operating Mechanisms

HPC™ High-Pressure Contact Switch

Application Information

Outlines and Dimensions

Application Information — HPC™ Switches with Integral Ground Fault Protection

Weights are for units with integrally mounted three-phase sensor.

Ampere Rating	Outline Drawing	Approx. Shipping Weight (Lbs.)	Approx. Net Weight (Lbs.)	Connectors Product Number
800A	139C4219	115	105	1
2000A	139C4114 sh 2	220	195	TS20FCA (Optional)
2500A	139C4114 sh 3	235	210	TS25FCA (Optional)
3000A	139C4114 sh 3	235	210	TS30FCA (Optional)
4000A	139C4114 sh 6	464	540	1-TS40LFCA 5-TS40FCA

Application Information — HPC™ Switches without Integral Ground Fault Protection

Data in the table below pertains to Type HPC™ switches without integral ground devices.

Ampere Rating	Outline Drawing	Approx. Shipping Weight (Lbs.)	Approx. Net Weight (Lbs.)	Connectors Product Number
800A	139C4219	85	75	1
2000A	139C4114 sh 2	190	165	TS20FCA (Optional)
2500A	139C4114 sh 3	205	180	TS25FCA (Optional)
3000A	139C4114 sh 3	205	180	TS30FCA (Optional)
4000A	139C4114 sh 6	429	505	1-TS40LFCA 5-TS40FCA

Minimum OEM Enclosure Dimensions and Ventilation Requirements²

Ampere Rating	Min Volume (Cubic Inches)	A Min Ventilation ³ Top and Bottom (Square Inches)	B Min Line to Ground (Inches)	C Min Height (Inches)	D Min Width (Inches)	E Mounting ⁴ Depth (Inches)	F Min to Ground or Insulation (Inches)
800A	8400	23	2	28	25	8.66	3.5
1200A-1600A	11100	63	2	30	25	8.66	3.5
2000A	28000	63	2	40	25	9.38	3
2500A	28000	172	2	40	25	9.38	3
3000A	30000	172	2	40	25	9.38	3
4000A	54650	189	9	52	30	11.12	3

Switch Dimensions (For Estimating Only)⁵

Ampere Rating ⁶	Dimension A	Dimension B	Dimension C	Dimension D	Dimension E	Dimension F
800	24.31	18.00	8.66	7.69	-	4.96
1200, 1600	26.72	18.00	8.66	7.69	-	4.96
2000, 2500, 3000	36.00	19.25	9.38	8.25	-	15.56
4000	40.00	22.38 ⁷	11.12	9.24	12.75 (Bø) 7.75 (Aø & Cø)	18.19

Note: For dimensions of neutral current sensor to be used with integral ground fault switches, page 9-34.

¹See page 9-33 for optional connectors.

²Dimensions are minimum requirements and do not represent enclosures on page 9-22.

³Ventilating openings can be in alternate locations but must provide equivalent ventilating areas.

⁴For switches with integrally mounted three-phase Ground Fault current sensor (Product Numbers with suffix G3T, G3R, GA3, BG3T, BGA3, BG3R) add 1.62 inch to dimension "E".

⁵For complete switch dimensions order outline drawings from application information above.

⁶For Product Numbers with suffix "B" (bottom-feed), invert drawing.

⁷With integral ground fault, overall width is 24 inches.

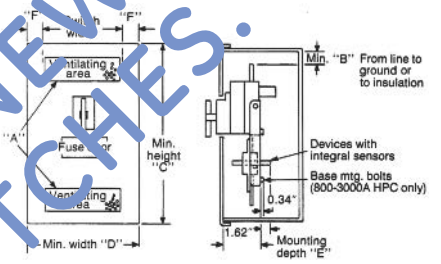

Minimum OEM Enclosure Dimensions and Ventilation Requirements

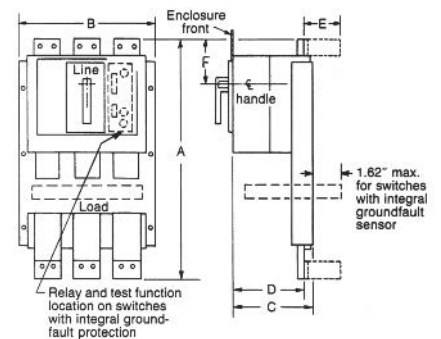

Switch Dimensions (For Estimating Only)



Disconnect Switches and Operating Mechanisms HPC™, New Generation High-Pressure Contact Switch

Section 9

Application Information
Outlines and Dimensions

Application Information – HPC™ Switches, New Generation

Ampere Rating	Feed	Outline Drawing
800A	Top	10112083P1
800A	Bottom	10112083P2
1200/1600A	Top	10112083P3
1200/1600A	Bottom	10112083P4
2000A	Top	10112083P5
2000A	Bottom	10112083P6
2500/3000A	Top	10112083P7
2500/3000A	Bottom	10112083P8
4000A	Top	10112083P11
4000A	Bottom	10112083P12

Weights – HPC™ Switches, New Generation

Frame Rating	Operation Type	Weight (lb)
800A	Manual	81
800A	Electrical	90
1200/1600A	Manual	95
1200/1600A	Electrical	104
2000A	Manual	110
2000A	Electrical	119
2500/3000A	Manual	210
2500/3000A	Electrical	219
4000A	Manual	400
4000A	Electrical	409

Enclosure Dimensions, Volume and Ventilation Requirements

Ampere Rating	Min Volume (Cubic Inches)	A Min Ventilation Top and Bottom ¹ (Square Inches)	B Min Line to Ground (Inches)	C Min Height (Inches)	D Min Width (Inches)	E Mounting Depth (Inches)	F Min to Ground or Insulation (Inches)
800A	6062	23	2	28	25	8.66	3.5
1200A-1600A	6495	63	2	30	25	8.66	3.5
2000A	9380	63	2	40	25	9.38	3
2500A	9380	172	2	40	25	9.38	3
3000A	9380	172	2	40	25	9.38	3
4000A	17347	189	9	52	30	11.12	3

Note: For dimensions of neutral current sensor to be used with integral ground fault switches, see outline drawings: 139C5016SH1 & SH2 (TSVG types) and 10112973P1 (SSVG types).

¹Ventilating openings can be in alternate location but must provide equivalent ventilating areas.



Disconnect Switches and Operating Mechanisms

HPC™, New Generation High-Pressure Contact Switch

Section 9

HPC™ Switch, New Generation

How to Order

1. Determine your new HPC™ 15-digit part number by using the Configurator (contact your authorized GE Distributor) and refer to the Buylog™ for complete list of options.
2. Check EliteNet™ for price and availability (For access to EliteNet™, contact your authorized GE Distributor). Note: Because of multiple possible combinations, only product numbers that have been ordered are in EliteNet™. If the product number you are interested in is not in EliteNet™, email the request to **GE.1STOP_REPLY@GE.com** to add it to the system.
3. Once the product number is loaded, the order can be placed via EliteNet™.
4. Note: Neutral CTs and T-Studs are ordered separately from the 15-digit product number.



Disconnect Switches and Operating Mechanisms HPC™, New Generation High-Pressure Contact Switch

Section 9

Accessories - HPC™ Switch, New Generation

All devices UL Listed for factory or field installation except where noted.

Accessories

The complete line of new generation HPC™ switch accessories may be either factory or field installed to meet user needs. The electronic shunt trip, the bell alarm, the bell alarm with mechanical lockout, and the undervoltage release modules are drop-in from the front of the switch, interchangeable across all frames, and require no field internal wiring or switch disassembly. Auxiliary switch modules are available in groups of 4, 8 or 12, NO/NC single-pole, double-throw (SPDT) switches. Their installation simply involves removal of switch cover, installation of the switch module, routing of wiring and installation of the pre-wired terminal block and re-installation of the cover. Auxiliary switches are also interchangeable across all new generation HPC™ switch frames.

Electrical Operator

The electrical operator mounts inside the front cover of the manually operated switch. This accessory can be added to any new generation HPC™ switch in the factory or the field to provide electrical spring charging and charge indication. **For remote closing, the remote close solenoid must be ordered separately.** All switches are prewired to dedicated secondary terminals for easy field installation. When electrical operation is used, either a shunt trip or an undervoltage release must be ordered separately.

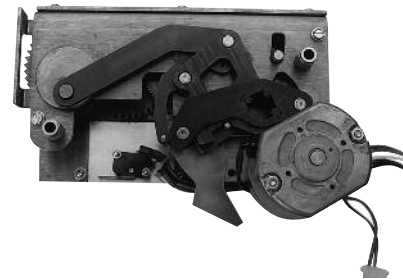

Electrical Operator

Ratings Vac	Ratings Vdc	Field Installable Product Number	Factory Installed Product Number
120	-	SPE120R	SPE120
240	-	SPE240R	SPE240
-	24	SPE024R	SPE024
-	48	SPE048R	SPE048
-	72	SPE072R	SPE072
-	125	SPE125R	SPE125

Remote Close Solenoid

This accessory provides an electrically operated solenoid which, when energized, closes the switch. It is suitable for control interlock schemes in which manual closing capability would not be convenient or desirable. The switch is provided with a manual close button, which can be replaced by the Hidden "ON" Button accessory and/or sealed using the Limited Access Pushbutton Cover accessory. The remote close accessory is continuously rated and has an anti-pump feature, which prevents a motor operated switch from repeatedly closing into a fault. Closing control voltage must be removed and re-applied for each switch closure.

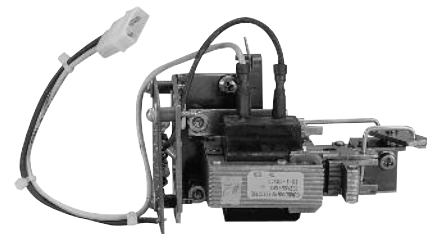

Remote Close Solenoid

Ratings Vac	Ratings Vdc	Field Installable Product Number	Factory Installed Product Number
120	-	SPRCS120R	SPRCS120
240	-	SPRCS240R	SPRCS240
-	24	SPRCS024R	SPRCS024
-	48	SPRCS048R	SPRCS048
-	72	SPRCS072R	SPRCS072
-	125	SPRCS125R	SPRCS125



Disconnect Switches and Operating Mechanisms HPC™, New Generation High-Pressure Contact Switch

Accessories - HPC™ Switch, New Generation

All devices UL Listed for factory or field installation except where noted.

Shunt Trip

The shunt trip accessory is an electronic module, which provides remote control capability to open the switch. When activated, the shunt trip module sends a signal to the control unit to open the switch. This allows the control unit to record, display, distinguish and communicate that the opening event was initiated by the shunt trip device. The shunt trip is continuously rated and requires no cut-off switch. When energized, the shunt trip supplies +24Vdc power to the control unit to power the display.



Shunt Trip Module

Ratings Vac	Ratings Vdc	Field Installable Product Number	Factory Installed Product Number
-	12	SPST012R	SPST012
24	24	SPST024R	SPST024
48	48	SPST048R	SPST048
120	125	SPST120R	SPST120
208	-	SPST208R	SPST208
240	250	SPST240R	SPST240
480	-	SPST480R ¹	SPST480 ¹
600	-	SPST600R ¹	SPST600 ¹

¹Kit contains externally mounted transformer.

Shunt Trip with Lockout Module

The shunt trip with lockout is identical to the regular shunt trip, but when energized, it will also prevent closure of an "open" switch by mechanically blocking both manual and electrical closing. When energized, the closing springs will not discharge, the movable contacts will not move; the contacts are "kiss free."

Ratings Vac	Ratings Vdc	Field Installable Product Number	Factory Installed Product Number
-	12	SPSTL012R	SPSTL012
24	24	SPSTL024R	SPSTL024
48	48	SPSTL048R	SPSTL048
120	125	SPSTL120R	SPSTL120
208	-	SPSTL208R	SPSTL208
240	250	SPSTL240R	SPSTL240
480	-	SPSTL480R ¹	SPSTL480 ¹
600	-	SPSTL600R ¹	SPSTL600 ¹

¹Kit contains externally mounted transformer.

Undervoltage Release Module

The undervoltage release is an electronic module used to open the switch when the monitored voltage drops below 35-60% of its rated value. The undervoltage release "resets" when the monitored voltage is re-established allowing the switch to re-close (the sealing voltage of the UVR is 60-85% of its rated voltage).

An undervoltage release trip operation is produced by the GTU control unit in response to a signal from the undervoltage release module. This allows the control unit to record, display, distinguish and communicate that the switch opening event was due to undervoltage release. Operation of the undervoltage release module will prevent switch contact closure, i.e. "kiss-free" operation. When energized, the undervoltage release supplies +24 Vdc power to the control unit to power the display.



Undervoltage Release Module

Ratings Vac	Ratings Vdc	Field Installable Product Number	Factory Installed Product Number
24	-	SPUV024ACR	SPUV024AC
48	-	SPUV048ACR	SPUV048AC
120	-	SPUV120ACR	SPUV120AC
208	-	SPUV208ACR	SPUV208AC
240	-	SPUV240ACR	SPUV240AC
480	-	SPUV480ACR ¹	SPUV480AC ¹
600	-	SPUV600ACR ¹	SPUV600AC ¹
-	12	SPUV012DCR	SPUV012DC
-	24	SPUV024DCR	SPUV024DC
-	48	SPUV048DCR	SPUV048DC
-	125	SPUV125DCR	SPUV125DC
-	250	SPUV250DCR	SPUV250DC

¹Kit contains externally mounted transformer.



Disconnect Switches and Operating Mechanisms HPC™, New Generation High-Pressure Contact Switch

Accessories - HPC™ Switch, New Generation

All devices UL Listed for factory or field installation except where noted.

Blown Fuse Protector

The Blown Fuse Protector (factory installed) is an accessory which includes components mounted on and external to the new HPC™ switch. Control wiring is connected from one end of each fuse mounting bus-strap to a 6 pt. terminal block mounted on the side of the new HPC™ switch. A shunt trip Lockout device or UVR trip device is included based on the product numbers below for remote opening of the new HPC™ switch in the event of a blown fuse to avoid single phasing.

The accessory also includes a pin-wheel style Blown Fuse Detector equipped with 3 trigger fuses + 1 spare. Wiring from the pin-wheel device to the new HPC™ switch is the responsibility of the switchboard builder.

Ratings Vac	Factory Installed Product Number	Field Installable Product Number ¹	Trip Accessory Provided
120	BFSPSTL120AC	BFSPSTL120ACR	SPSTL120
208	BFSPSTL208AC	BFSPSTL208ACR	SPSTL208
240	BFSPSTL240AC	BFSPSTL240ACR	SPSTL240
120	BFSPUV120AC	BFSPUV120ACR	SPUV120AC
208	BFSPUV208AC	BFSPUV208ACR	SPUV208AC
240	BFSPUV240AC	BFSPUV240ACR	SPUV240AC
120	BFSPST120AC	BFSPST120ACR	SPST120
208	BFSPST208AC	BFSPST208ACR	SPST208
240	BFSPS240AC	BFSPST240ACR	SPST240

¹For field installable kits only, the Pin wheel style Blown Fuse Detector is not included due to UL accessory listing requirements.

Source the Boltswitch PW-2 Blown Fuse Detector separately and follow that manufacturer's instructions for mounting and use.

Bell Alarm (Alarm Only)

The bell alarm module is used to signal switch "tripped" status to other accessories (e.g., external alarm devices, indicating lights, relays, or logic circuits) for remote indication and interlocking functions. The bell alarm response is configurable by means of rear-mounted DIP switches on the control unit. The bell alarm can be made to operate in response to an overcurrent (including ground fault) or protective relay trip and/or a shunt trip operation, and/or operation of the undervoltage release module. It is not actuated as a result of normal switch "ON/OFF" operation.

This module provides a visual, mechanical pop-out target, which protrudes through the face of the switch door when it operates. The bell alarm may be reset manually by depressing the mechanical target, or automatically by closing the switch.

The bell alarm is provided with one SPDT switch with control power duty contacts as shown in the auxiliary switch accessories.



Bell (Alarm Only)

Ratings Vac	Ratings Vdc	Field Installable Product Number	Factory Installed Product Number
240	125-250	SPBAA240R	SPBAA240
600	125-250	SPBAA600R ²	SPBAA600 ²

²600 Vac module not UL Listed.



Disconnect Switches and Operating Mechanisms HPC™, New Generation High-Pressure Contact Switch

Accessories - HPC™ Switch, New Generation

All devices UL Listed for factory or field installation except where noted.

Bell Alarm With Lockout

The bell alarm with lockout module combines both the bell alarm and a manual lockout function. The bell alarm switch operates identically to the standard bell alarm module, except that the mechanical pop-out target must be manually reset before the switch can be closed.

Operation of the bell alarm with lockout module can be independently set by means of setting the DIP switches at the rear of the control unit. Current rating of the single SPDT switch is identical to the auxiliary switch accessories.



Bell Alarm with Mechanical Reset Lockout

Ratings Vac	Ratings Vdc	Field Installable Product Number	Factory Installed Product Number
240	125-250	SPBAL240R	SPBAL240
600	125-250	SPBAL600R ¹	SPBAL600 ¹

¹600 Vac module not UL Listed.

Auxiliary Switch

An auxiliary switch signals the HPC™ switch's primary contact position (i.e., OPEN or CLOSED) to other devices, such as indicating lights, relays or logic circuits. This enables the user to provide remote indication, interlocking or control operations as a function of HPC™ switch primary contact position. The auxiliary switch operation is independent of the method by which the HPC™ switch is opened or closed. The auxiliary switch does not distinguish between a "tripped" or "open" condition. The auxiliary switch contacts follow the main HPC™ switch contacts on opening and precede them on closing.

Auxiliary switch modules are available with 4, 8 or 12 NO/NC (SPDT) switches for control power duty ac/dc ratings. When ordered for field installation, an auxiliary switch module comes pre-wired to its own terminal board, which mounts with one screw to the left of the HPC™ switch. All switch ratings are 6A at 120V-600 Vac, 1/2A at 125 Vdc and 1/4A at 250 Vdc.

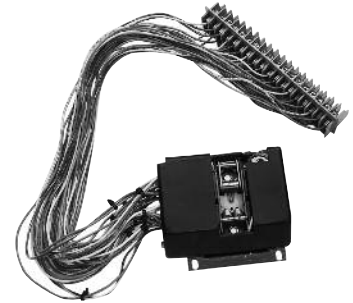

Auxiliary Switch with Pre-wired Secondary Terminals

Ratings Vac	Ratings Vdc	No. of SPDT Switch Elements (Contacts)	Field Installable Product Number	Factory Installed Product Number
240	125-250	4	SPAS240AB4R	SPAS240AB4
240	125-250	8	SPAS240AB8R	SPAS240AB8
240	125-250	12	SPAS240AB12R	SPAS240AB12
600	125-250	4	SPAS600AB4R ¹	SPAS600AB4 ¹
600	125-250	8	SPAS600AB8R ¹	SPAS600AB8 ¹

¹600 Vac module not UL Listed.



Disconnect Switches and Operating Mechanisms HPC™, New Generation High-Pressure Contact Switch

Section 9

Accessories - HPC™ Switch, New Generation

All devices UL Listed for factory or field installation except where noted.

Mechanical Operations Counter

The mechanical operations counter is mounted behind the front cover of the switch. It is viewable through a rectangular knockout window opening in the switch cover. It is a five-digit, non-resettable counter, which is actuated each time the switch is opened by any means.

Field Installed Product Number	Factory Installed Product Number
SPCOUNTER	SPCOUNTER



Mechanical Operations Counter

Limited Access Pushbutton Cover

This accessory limits access to "ON/OFF" control of a switch to authorized personnel. The pushbutton cover accessory consists of transparent hinged covers that can be individually sealed to the limited access assembly. Both the "ON" and "OFF" buttons can be pilot drilled to allow use of a 1/8" rod to operate either one or both pushbuttons.

Field Installed Product Number	Factory Installed Product Number
SPPBCOVER	SPPBCOVER



Limited access pushbutton cover

Hidden "ON" Button

The hidden "ON" button is assembled to the mechanism behind an unlabeled, false pushbutton. Manual closing of the switch can only be performed by means of a small diameter rod. This accessory is used to limit access to the manual "ON" control to authorized personnel.

Field Installed Product Number	Factory Installed Product Number
SPPBNONR	SPPBNON



Activating the switch closing mechanism through the hole in the Hidden "ON" Button

Maintenance/Repair Parts

Description	Product Number
Top Cover and Rating Labels	SPBIICOVER ¹
Visible "On" Button Conversion	SPPBRONR

¹Special handling and order entry required to preserve UL Listing of switch. Contact Post Sale Service for additional details of special process.



Disconnect Switches and Operating Mechanisms HPC™, New Generation High-Pressure Contact Switch

Accessories - HPC™ Switch, New Generation

All devices UL Listed for factory or field installation except where noted.

Key Interlock Provisions

The key interlock provision enables the user to mount a one- to four-cylinder, narrow-faced, Kirk-type FN or Superior customer-supplied lock on the face of the switch. This accessory provides mounting for key interlocks that are furnished by the customer. The key interlock provision works in conjunction with the padlock provision. The key interlock extends a lever through the padlock hasp when the key is turned to the key removal or bolt extended position. Additionally, the accessory provides a hasp for mounting three padlocks with 1/4" to 3/8" diameter shanks.

Key Interlock Reference Table

Product Number	Number of Locks	Kirk Key Lock Product Number	Superior Product Number
SPK4	1	KFN00001 ¹	S105827Y
SPK4	2	KFN00002 ¹	S105828Y
SPK4	3	KFN00003 ¹	S105829Y
SPK4	4	KFN00004 ¹	S105827-4Y

¹Final digit may be 0, 1, 2 or 3 depending on number of key removal positions.

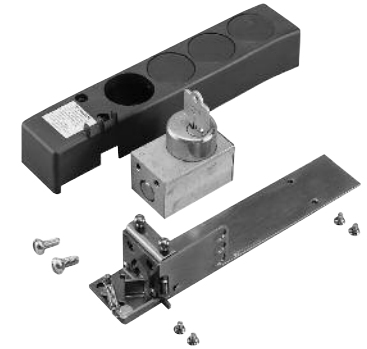

Key Interlock Kit (lock not included)

Product Numbers, Key Interlock Provisions

Circuit Breaker Envelope Size (Amps)	Number of Key Locks	Field Installed Product Number	Factory Installed Product Number
All	1 to 4	SPK4R	SPK4

Door Interlock

The door interlock provides interlocking of the switch compartment's hinged door so that the switch must be in the "OFF" position before the door can be opened. The door interlock is defeatable with a small tool to allow authorized access.

Field Installed Product Number	Factory Installed Product Number
SPDILR	SPDIL

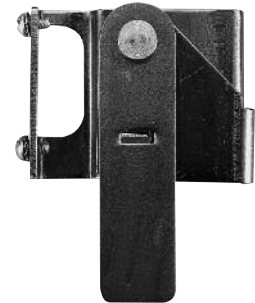

Door Interlock

Padlock Provisions (Standard)

Padlocking provisions are standard on all new generation HPC™ switches. When the switch is in the open position, and the padlock hasp is raised at least 1/4", the switch cannot be closed mechanically or electrically. The hasp accepts up to three padlocks with 1/4" to 3/8" diameter shanks.



Accessories
UL Listed

Adapter Kits

(Accepts either lugs, bus, or Anderson VCEL VersaCrimp)

For Line or Load end of 3-pole switch.

Ampere Rating	Product Number
800A	THPCLUGA08
1200A	
1600A	TPLUGA16

Field Installed Lugs Kits 800-1600 Ampere Switches—Direct Mounting

Field installed only. Kits consist of lugs and hardware for direct mounting to switch terminal straps (multiple-hole tang lugs) or lugs for mounting to 800 ampere terminal adapter kit. Order three kits for three-pole line or load end. For 1600-ampere, copper conductors must be used.

Ampere Rating	Accessory Type	Wire Range Cu/Al	Product Number
800A	Lug Kit Line & Lug Kit Load	(3) 300-750	THPCLUG308
1200A, 1600A	Lug Kit Line	(4) 500-800 kcmil	TPLUG408
1200A, 1600A	Lug Kit Load	(4) 500-800 kcmil	THPCLUG408

Field Installed Lugs Kits 2000-4000 Ampere Switches—Direct Mounting

Field installed only. To terminate line and load cables, must be used in conjunction with bus-connection adapter on page 9-20 (T Studs). Each lug kit includes lugs, straps and hardware for three-phase line or load connections. Each cable lug accommodates 1-3/0 Cu or 250 kcmil Al to 800 kcmil Cu-Al. Accepts Anderson VersaCrimp when lugs are removed from straps.

Ampere Rating	No. of Lugs per Pole Line or Load End	Product Number
2000A	6	TSLUG20
2500A	7	TSLUG25
3000A	9	TSLUG30
4000A	11	TSLUG40

Field Installed T Studs

Field installed only. May be used to adapt line and load terminals of switch to vertical or horizontal bus arrangements. Three required for line or load connections on three-phase bus. Accepts either lugs, bolts, or Anderson VCEL VersaCrimp.

Basic Switch Rating (Amperes)	Product Number
800	THPC08FCA ¹
1200-1600	TP16FCA
2000	TS20FCA
2500	TS25FCA
3000	TS30FCA
4000	TS40FCA ² TS40LFCA ³

¹For vertical bussing only.

²For load terminals and left/right line terminals.

³For center pole, line terminal.

Lug Kits (For use with adapter only)

(Accepts either lugs, bus, or Anderson VCEL VersaCrimp)

One per Product Number; standard carton contains:

6—TPLUG106;

3—TPLUG108.

Ampere Rating	No. of Lugs per Pole Line or Load End	Wire Range Cu/Al	Product Number
800A	3	(1) #2-600 kcmil or (2) 1/0-250 kcmil	TPLUG106
800A	3	(1) 3/0-800 kcmil Cu or (1) 250-800 kcmil Al	TPLUG108

Trimplate

Factory Installed Product Number	Field Installable Product Number
SPTRIMPLATE	SPTRIMPLATER



Disconnect Switches and Operating Mechanisms HPC™, New Generation High-Pressure Contact Switch

Accessories - HPC™ Switch, New Generation

Neutral Current Sensors¹

HPC™ Switch Frame (Amperes)	HPC™ Switch Sensor Rating (Amperes)	Neutral Sensor Rating or Tap Settings (Amperes)	Product Number
800	200	200	TSVG302
	400	400/200	TSVG304A
800-1600	400	600/300 ²	TSVG306A
	800	800/400	TSVG308A
1600	1000	800/400 ²	TSVG808A
	1000	1000/500	TSVG810A
	1600	1200/600 ²	TSVG812A
	1600	1600/1000	TSVG816A
2000	2000	2000/1000	TSVG820A
	1000	800/400 ²	TSVG808A
3000	1000	1000/500	TSVG810A
	1000	1200/600 ²	TSVG812A
	1000	1600/1000 ²	TSVG816A
	2000	2000/1200	TSVG820A
	2500	2500/1800	TSVG825A
4000	3000	3000/2400	TSVG830A
	4000	4000/3000	TSVG940A



TSVG Neutral Current Sensor

¹Match neutral current sensor rating (or tap setting) to new HPC™ switch sensor rating.

²For use with multiple source ground fault protection schemes. Rating does not match EntelliGuard™ TU frame sensor.

Neutral Current Sensors¹

HPC™ Switch Frame (Amperes)	HPC™ Switch Sensor Rating (Amperes)	Neutral Sensor Rating or Tap Settings (Amperes)	Product Number of Window Sensor	Inside Diameter (inches)
800	800	800/400	SSVG808W	4.25
1200	1200 ³	2000/1200	SSVG820W	5.63
	1600 ³	1600/1000	SSVG816W	5.63
1600	1600	1600/1000	SSVG816W	5.63
2000	2000	2000/1200 ³	SSVG820W	5.63
2500	2500	2500/1800	SSVG825W	5.63
3000	3000	4000/3000	SSVG940W	6.50
4000	4000	4000/3000	SSVG940W	6.50



SSVG Neutral Current Sensors

¹Match neutral current sensor rating (or tap setting) to new HPC™ Switch sensor rating.

³At time of initial product release, the 1200A new HPC™ Switch was using 1600A installed sensors and a 1200A rating plug. Later models may or may not use 1200A phase sensors. Match Neutral sensor tap to HPC™ sensor rating.



Disconnect Switches and Operating Mechanisms HPC™, New Generation High-Pressure Contact Switch

Section 9

HPC Switch, New Generation

Reference Publications

Auxiliary Switch Module	GEH-6274
Bell Alarm – Alarm Only	GEH-6275
Door Interlock	GEH-6276
Lugs & Adapters for 800–2000 A Frames	GEH-4546
Bell Alarm with Lockout	GEH-6278
Key Interlock Mounting Provision	GEH-6279
Mechanical Counter	GEH-6280
Motor Operator Mechanism	GEH-6281
Push Button Cover	GEH-6282
Remote Close	GEH-6283
Shunt Trip and Shunt Trip with Lockout (except 480 and 600 Vac)	GEH-6284
Shunt Trip and Shunt Trip with Lockout, 480 & 600 Vac	GEH-6519
Undervoltage Release (except 480 and 600 Vac)	GEH-6285
Undervoltage Release, 480 & 600 Vac	GEH-6520
Instructions, HPC™ Heat Sink Installation	DEH-41694
Instructions, HPC™ Blown Fuse Protector	DEH-41695
EntelliGuard™ TU Trip Unit	DEH-4567
HPC™ Switches, New Generation, User's Guide	DEH-41689
Time Current Curves HPC™ Switches, New Generation, Ground Fault	DES-121
Time Current Curves HPC™ Switches, New Generation, Adjustable Selective Instantaneous Trip,	
Reduced Energy Let-Through (RELT)	DES-122
HPC™ Switches, New Generation, Instantaneous Protection Guide	DEE-715



Disconnect Switches and Operating Mechanisms

Premium Duty QMW, Heavy Duty QMR

Section 9

Individual Components

30-200 Amperes

240, 480, 600 Vac, 250 Vdc

Product Description

QMR and QMW switches (30-200 amperes), fuse and no-fuse kits are UL Recognized Components, File E-36152, and UL Recognized to Canadian safety requirements under the Component Recognition Program of Underwriters Laboratories Inc.

The 30-200 ampere fusible switches are UL Recognized for use on circuits capable of delivering not more than 200,000 rms symmetrical amperes at 240 or 600Vac when fused with Class R rated size fuses. Refer to the table 7-3 for the appropriate Class R Fusing Kit. They are suitable for use with Type STDA flange handles and variable depth operating mechanisms on page 9-28.

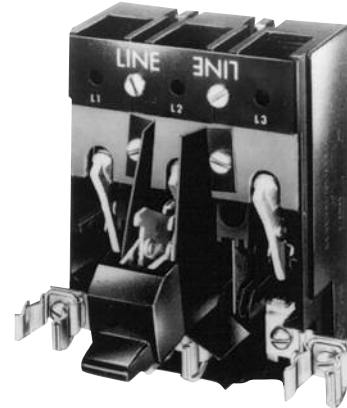

QMW Premium Heavy-Duty Switch
(with Fuse Clips from Fuse Kit)

Basic Switches - Premium Duty (QMW) and Heavy Duty (QMR)

Duty Type	Ampere Rating	Interrupting Rating Amperes Symmetrical 600Vac, 3-phase	Product Number
Premium Duty - QMW	30A	950	THMC31 ¹
Premium Duty - QMW	60A	1700	THMC32 ¹
Premium Duty - QMW	100A	1800	THMC33 ¹
Premium Duty - QMW	200A	3600	THMC34
Heavy Duty - QMR	30A	420	THMS31 ¹
Heavy Duty - QMR	60A	900	THMS32 ¹
Heavy Duty - QMR	100A	1700	THMS33 ¹
Heavy Duty - QMR	200A	3400	THMS34

Handle Operator: Order from pages 9-28 or 9-29.

¹Specify special screw kit if load risers are to be fastened from underside of base. Two screws required per switch; 10 screws in each product number THMC1 kit.



Disconnect Switches and Operating Mechanisms Premium Duty QMW, Heavy Duty QMR (continued)

Section 9

Individual Components

30-200 Amperes

240, 480, 600 Vac, 250 Vdc

Fuse and No-Fuse Kits — Horsepower Ratings 3-pole

Product Number	Description of Kit	HP Rating, AC, 3-Phase, NEC Std. Fuse @ 240Vac	HP Rating, AC, 3-Phase, NEC Std. Fuse @ 480Vac	HP Rating, AC, 3-Phase, NEC Std. Fuse @ 600Vac	HP Rating, AC, 3-Phase, Time-Delay Fuse @ 240Vac	HP Rating, AC, 3-Phase, Time-Delay Fuse @ 480Vac	HP Rating, AC, 3-Phase, Time-Delay Fuse @ 600Vac	HP Rating, 125Vdc	HP Rating, 250Vdc
THMC3100	No Fuse	-	-	-	7.5	20	25	3	5
THMC3200	No Fuse	-	-	-	20	40	50	5	10
THMC3300	No Fuse	-	-	-	30	60	75	-	20
THMC3400	No Fuse	-	-	-	60	125	150	-	40
THMC3121	30A, 240Vac/250Vdc	3	-	-	7.5	-	-	3	5
THMC3222	60A, 240Vac/250Vdc	5	-	-	15	-	-	5	10
THMC3161	30A, 600Vac	-	5	7.5	-	15	20	3	5
THMC3262	60A, 600Vac	-	15	20	-	40	50	5	10
THMC3363	100A, 240Vac/250Vdc 100A, 600Vac	10	25	30	30	60	75	-	20
THMC3364	200 A, 600Vac	25	50	60	-	-	-	-	-
THMC3464	200A, 240Vac/250Vdc 200A, 600Vac	25	50	60	60	125	150	-	40
THMC3465	400A, 600Vac	50	100	125	-	-	-	-	-

Fuse and No-Fuse Kits (Includes load block, clips, and lugs)

Product Number	Description of Kit	Switch Product Number	Fuse Type	No. of Poles	Lug Wire Size
THMC3100 ²	No Fuse	THMC31 or THMS31	No Fuse	3	Wire Keeper Term. for #14-8 CU
THMC3200	No Fuse	THMC32 or THMS32	No Fuse	3	CU 14-2 AL 12-2
THMC3300	No Fuse	THMC33 or THMS33	No Fuse	3	CU 14-0 AL 12-0
THMC3400	No Fuse	THMC34 or THMS34	No Fuse	3	6-250 kcmil CU-AL
THMC3121 ¹	30A, 240Vac/250Vdc	THMC31 or THMS31	NEC Standard	3	Wire Keeper Term. for #14-8 CU
THMC3222 ¹	60A, 240Vac/250Vdc	THMC31 or THMS31	NEC Standard	3	Wire Keeper Term. for #14-8 CU
THMC3161 ¹	30A, 600Vac	HMC31 or THMS31	NEC Standard and Class J	3	Wire Keeper Term. for #14-8 CU
THMC3262 ¹	60A, 600Vac	THMC31 or THMS31	NEC Standard and Class J	3	Wire Keeper Term. for #14-8 CU
THMC3363	100A, 240Vac/250Vdc 100A, 600Vac	THMC32 or THMS32	NEC Standard and Class J	3	CU 14-2 AL 12-2
THMC3364	200A, 600Vac	THMC33 or THMS33	NEC Standard and Class J	3	CU 14-0 AL 12-0
THMC3464	200A, 240Vac/250Vdc 200A, 600Vac	THMC34 or THMS34	NEC Standard and Class J	3	6-250 kcmil CU-AL
THMC3465	400A, 600Vac	THMC34 or THMS34	NEC Standard and Class J	3	6-250 kcmil CU-AL

No-fuse ratings indicate switch capability as permitted by UL 508 (Ind. Cont. Equip.), additional hp ratings correspond to commercially available fuses.

For DC use outer poles.

¹Can be used for one-step underfusing for next higher current-rated disconnect.

²Maximum UL listing 20 hp. at 600V.



Disconnect Switches and Operating Mechanisms

Premium Duty QMW, Heavy Duty QMR

Factory Assembled Fuse Clips
Choice of Handle Style
30-600 Amperes
240, 480, 600 Vac, 250 Vdc

Product Description

These 30-600 ampere disconnect switches are complete with Class H fuse clips except where noted, line/load lugs and handle operators, all factory assembled, and are mounted on a heavy-gauge steel backplate. They are UL Recognized Components, File E-36152, and UL Recognized to Canadian safety requirements under the Component Recognition Program of Underwriters Laboratories Inc.

The 30-200 ampere fusible switches are UL Recognized for use on circuits capable of delivering not more than 200,000 rms symmetrical amperes at 240 or 600Vac when fused with Class R rated size fuses. Refer to the table below for the appropriate Class R Fusing Kit. Class H Fuse Clips are standard. Suitable for NEMA 1 and NEMA 12 enclosures.



QMR Disconnect with TDR Handle

Assembled with Lugs, Fuse Clips and Handle Operators — Horsepower Ratings

Duty Type	Disconnect Switch Rating (Amperes)	Max. HP Rating @ 240Vac 3-Phase	Max. HP Rating @ 480Vac 3-Phase	Max. HP Rating @ 600Vac 3-Phase	Max. HP Rating @ 250 Vdc	Product Number
Heavy Duty – QMR	30A	7.5	20	20	5	THMR3100
Heavy Duty – QMR	30A	7.5	–	–	5	THMR3121
Heavy Duty – QMR	30A	7.5	15	20	5	THMR3161
Heavy Duty – QMR	60A	20	40	50	10	THMR3200
Heavy Duty – QMR	60A	15	–	–	10	THMR3222
Heavy Duty – QMR	60A	–	30	50	10	THMR3262
Heavy Duty – QMR	100A	30	60	75	20	THMR3300
Heavy Duty – QMR	100A	30	60	75	20	THMR3363 ¹
Heavy Duty – QMR	200A	60	125	150	40	THMR3400
Heavy Duty – QMR	200A	60	125	150	40	THMR3464 ¹
Heavy Duty – QMR	400A	125	250	350	50	THMA35NF
Heavy Duty – QMR	400A	125	–	–	50	THMA3525
Heavy Duty – QMR	400A	125	250	350	–	THMA3565
Heavy Duty – QMR	400A	125	250	350	–	THMA35J5 ²
Heavy Duty – QMR	400A	125	250	350	50	THMRB35NF
Heavy Duty – QMR	400A	125	250	350	–	THMRB3565
Heavy Duty – QMR	400A	125	250	350	–	THMRB35J5 ²
Heavy Duty – QMR	600A	200	400	500	50	THMA36NF
Heavy Duty – QMR	600A	200	400	500	–	THMA3665
Heavy Duty – QMR	600A	200	400	500	–	THMA3666 ³
Heavy Duty – QMR	600A	200	400	500	–	THMA36J6 ²
Heavy Duty – QMR	600A	200	400	500	50	THMRB36NF
Heavy Duty – QMR	600A	200	400	500	–	THMRB3666 ³
Heavy Duty – QMR	600A	200	400	500	–	THMRB36J6 ²
Heavy Duty – QMR	600A	200	400	500	–	THMRB36L7 ⁴
Premium Duty – QMW	30A	7.5	–	–	5	THMCR3121
Premium Duty – QMW	30A	7.5	15	20	5	THMCR3161
Premium Duty – QMW	60A	20	40	50	10	THMCR3200
Premium Duty – QMW	60A	15	–	–	10	THMCR3222
Premium Duty – QMW	60A	–	30	50	10	THMCR3262
Premium Duty – QMW	100A	30	60	75	20	THMCR3300
Premium Duty – QMW	100A	30	60	75	20	THMCR3363
Premium Duty – QMW	200A	60	125	150	40	THMCR3400
Premium Duty – QMW	200A	60	125	150	40	THMCR3464

400 and 600 Ampere QMR units are UL Recognized on 100,000 Ampere rms circuits when fused with rated size Class J or R fuses.

Order Door Ring Interlock Kit—343L483G4; Gasket Kit—792A489G3.

400 and 600 Ampere switches with TDM handle have “pendulum” operation.

400 and 600 Ampere QMR units are UL Recognized on 100,000 Ampere rms circuits when fused with rated size Class J or R fuses.

¹Field convertible to 250 Volt fusing.

²Supplied with Class J fuse clips.

³600 Ampere, 600 Volt Class H fused to Class J fusing. Order kit Product Number THJ6. One kit required per switch. 400 Ampere units can be field converted by moving the fuse block toward the switch.

⁴Supplied with Class L fuse clips.



Disconnect Switches and Operating Mechanisms Premium Duty QMW, Heavy Duty QMR (continued)

Section 9

Factory Assembled Fuse Clips
Choice of Handle Style
30-600 Amperes
240, 480, 600 Vac, 250 Vdc

Assembled Switches with Lugs, Fuse Clips and Handle Operators

Duty Type	Ampere Rating	Fuse Clip Rating (Ampere) @ 250Vdc Max.	Fuse Clip Rating (Ampere) @ 600Vac Max.	Handle Style	Lug Wire Size	Product Number
Heavy Duty – QMR	30A	No Fuse	No Fuse	TDR Rotary Handle	Wire Keeper, Term. for #14-8 Cu	THMR3100
Heavy Duty – QMR	30A	30	-	TDR Rotary Handle	Wire Keeper, Term. for #14-8 Cu	THMR3121
Heavy Duty – QMR	30A	-	30	TDR Rotary Handle	Wire Keeper, Term. for #14-8 Cu	THMR3161
Heavy Duty – QMR	60A	No Fuse	No Fuse	TDR Rotary Handle	CU 14-2 AL 12-2	THMR3200
Heavy Duty – QMR	60A	60	-	TDR Rotary Handle	CU 14-2 AL 12-2	THMR3222
Heavy Duty – QMR	60A	-	60	TDR Rotary Handle	CU 14-2 AL 12-2	THMR3262
Heavy Duty – QMR	100A	No Fuse	No Fuse	TDR Rotary Handle	10-1/0 Cu/Al	THMR3300
Heavy Duty – QMR	100A	100	100	TDR Rotary Handle	10-1/0 Cu/Al	THMR3363 ¹
Heavy Duty – QMR	200A	No Fuse	No Fuse	TDR Rotary Handle	6-250 kcmil Cu/Al	THMR3400
Heavy Duty – QMR	200A	200	200	TDR Rotary Handle	6-250 kcmil Cu/Al	THMR3464 ¹
Heavy Duty – QMR	400A	No Fuse	No Fuse	TDM Adjustable Shaft Handle	(1) # 22-600 kcmil Cu/Al or (2) 1/0-3/0 Cu or (2) 1/0-250 kcmil Al	THMA35NF
Heavy Duty – QMR	400A	400	-	TDM Adjustable Shaft Handle	(1) # 22-600 kcmil Cu/Al or (2) 1/0-3/0 Cu or (2) 1/0-250 kcmil Al	THMA3525
Heavy Duty – QMR	400A	-	400	TDM Adjustable Shaft Handle	(1) # 22-600 kcmil Cu/A or (2) 1/0-3/0 Cu or (2) 1/0-250 kcmil Al	THMA3565
Heavy Duty – QMR	400A	-	400	TDM Adjustable Shaft Handle	(1) # 22-600 kcmil Cu/Al or (2) 1/0-3/0 Cu or (2) 1/0-250 kcmil Al	THMA35J5 ²
Heavy Duty – QMR	400A	No Fuse	No Fuse	TDR Rotary Handle	(1) # 22-600 kcmil Cu/Al or (2) 1/0-3/0 Cu or (2) 1/0-250 kcmil Al	THMRB35NF
Heavy Duty – QMR	400A	-	400	TDR Rotary Handle	(1) # 22-600 kcmil Cu/Al or (2) 1/0-3/0 Cu or (2) 1/0-250 kcmil Al	THMRB3565
Heavy Duty – QMR	400A	-	400	TDR Rotary Handle	(1) # 22-600 kcmil Cu/Al or (2) 1/0-3/0 Cu or (2) 1/0-250 kcmil Al	THMRB35J5 ²
Heavy Duty – QMR	600A	No Fuse	No Fuse	TDM Adjustable Shaft Handle	(2) # 4-600 kcmil Cu/Al	THMA36NF
Heavy Duty – QMR	600A	400	400	TDM Adjustable Shaft Handle	(2) # 4-600 kcmil Cu/Al	THMA3665
Heavy Duty – QMR	600A	-	600	TDM Adjustable Shaft Handle	(2) # 4-600 kcmil Cu/Al	THMA3666 ³
Heavy Duty – QMR	600A	-	600	TDM Adjustable Shaft Handle	(2) # 4-600 kcmil Cu/Al	THMA36J6 ²
Heavy Duty – QMR	600A	No Fuse	No Fuse	TDR Rotary Handle	(2) # 4-600 kcmil Cu/Al	THMRB36NF
Heavy Duty – QMR	600A	-	600	TDR Rotary Handle	(2) # 4-600 kcmil Cu/Al	THMRB3666 ³
Heavy Duty – QMR	600A	-	600	TDR Rotary Handle	(2) # 4-600 kcmil Cu/Al	THMRB36J6 ²
Heavy Duty – QMR	600A	-	800	TDR Rotary Handle	(2) # 4-600 kcmil Cu/Al	THMRB36L7 ⁴

400 and 600 Ampere QMR units are UL Recognized on 100,000 Ampere rms circuits when fused with rated size Class J or R fuses.

Order Door Ring Interlock Kit—343L483G4. Gasket Kit—792A489G3.

400 and 600 Ampere switches with TDM handle have “pendulum” operation.

400 and 600 Ampere QMR units are UL Recognized on 100,000 Ampere rms circuits when fused with rated size Class J or R fuses.

¹Field convertible to 250 Volt fusing.

²Supplied with Class J fuse clips.

³600 Ampere, 600 Volt Class H fused to Class J fusing. Order kit Product Number THJ6. One kit required per switch. 400 Ampere units can be field converted by moving the fuse block toward the switch.

⁴Supplied with Class L fuse clips.



Disconnect Switches and Operating Mechanisms Premium Duty QMW, Heavy Duty QMR (continued)

Factory Assembled Fuse Clips

Choice of Handle Style

30-600 Amperes

240, 480, 600 Vac, 250 Vdc

Assembled Switches with Lugs, Fuse Clips and Handle Operators (Continued)

Duty Type	Ampere Rating	Fuse Clip Rating (Ampere) @ 250Vdc Max.	Fuse Clip Rating (Ampere) @ 600Vac Max.	Handle Style	Lug Wire Size	Product Number
Premium Duty - QMW	30A	30	-	TDR Rotary Handle	Wire Keeper, Term. for #14-8 Cu	THMCR3121
Premium Duty - QMW	30A	-	30	TDR Rotary Handle	Wire Keeper, Term. for #14-8 Cu	THMCR3161
Premium Duty - QMW	60A	No Fuse	No Fuse	TDR Rotary Handle	CU 14-2 AL 12-2	THMCR3200
Premium Duty - QMW	60A	60		TDR Rotary Handle	CU 14-2 AL 12-2	THMCR3222
Premium Duty - QMW	60A		60	TDR Rotary Handle	CU 14-2 AL 12-2	THMCR3262
Premium Duty - QMW	100A	No Fuse	No Fuse	TDR Rotary Handle	10-1/0 Cu/Al	THMCR3300
Premium Duty - QMW	100A	100	100	TDR Rotary Handle	10-1/0 Cu/Al	THMCR3363
Premium Duty - QMW	200A	No Fuse	No Fuse	TDR Rotary Handle	6-250 kcmil Cu/Al	THMCR3400
Premium Duty - QMW	200A	200	200	TDR Rotary Handle	6-250 kcmil Cu/Al	THMCR3464

400 and 600 Ampere QMR units are UL Recognized on 100,000 Ampere rms circuits when fused with rated size Class J or R fuses.

Order Door Ring Interlock Kit—343L483G4. Gasket Kit—792A489G3.

400 and 600 Ampere switches with TDM handle have "pendulum" operation.

400 and 600 Ampere QMR units are UL Recognized on 100,000 Ampere rms circuits when fused with rated size Class J or R fuses.

¹Field convertible to 250 Volt fusing.

²Supplied with Class J fuse clips.

³600 Ampere, 600 Volt Class H fused to Class J fusing. Order kit Product Number THJ6. One kit required per switch. 400 Ampere units can be field converted by moving the fuse block toward the switch.

⁴Supplied with Class L fuse clips.

Class R Fusing Conversion Kits

Switch Rating		Field Installed
Amperes	Volts	Product Number
30	250Vdc	TPBRK12A
30	600Vac	TPBRK16A
60	250Vdc	TPBRK22A
60	600Vac	TPBRK26A
100	250Vdc/600Vac	TPBRK36A
200	250Vdc/600Vac	TRK46A
400	250Vdc/600Vac	TPBRK56A ⁵
600	250Vdc/600Vac	TRK66A ⁵

⁵Not suitable for use with individual components shown on pages 9-23 and 9-24.



Product Description

Type STDA Flange Handles and Variable Depth Operating Mechanisms For Use With QMR/QMW 30-200A Disconnects

- Designed to meet automotive duty specifications.
- NEMA 12/13 and 4/4X, UL Recognized Components, File E-57253, and UL Recognized to Canadian safety requirements under the Component Recognition Program of Underwriters Laboratories Inc.
- For right- or left-hand flange mounting—field convertible.
- Mounting dimensions to fit standard flange enclosures 8"-24" deep.
- Drilling templates and detailed installation instructions.

Flange Handle Selection

Product Number STDA1 (6-inch) and STDA2 (10-inch) flange handles are interchangeable. While all operating mechanisms can be easily operated with the 6-inch STDA1 handle, the 10-inch STDA2 may be used to obtain lower operating force and/or to provide a proportionally larger handle on large enclosures.



Flange Handle, STDA1

Construction Details

Flange Handles

- Rugged aluminum alloy cast housing with provision for locking in off position with up to three 3/16- to 5/16-inch diameter padlocks.
- Optional provision for locking on by drilling hole in die casting.
- O-ring seals for dust-tight/oil-tight duty.
- Gusseted, 3/32-in. thick double-sided steel handle with large, red-black self-extinguishing grade plastic grip.

Variable Depth Operating Mechanisms

- Plated steel yokes and integral mounting plates are 1/8-inch thick minimum.
- Operating yokes have toggle spring assist for positive on/off operation.
- Mounting plates include positive yoke stops to prevent undue wear on disconnect and circuit breaker toggle handles.
- Threaded 3/8-in. dia. drive rod (16-in. length—standard, 22-in. length—optional) provides simple variable depth connection between flange-mounted handle and operating mechanism.
- Suitable for use with Hoffman Bulletin A-25 or equivalent enclosures.

Flange Handles

Enclosure Type	Nominal Length (Inches)	Installation Instruction Number	Drilling Template Number	Product Number
NEMA Type 12/13	6	GEH-5314	GEH-5314	STDA1
NEMA Type 12/13	10	GEH-5314	GEH-5314	STDA2
NEMA Type 4/4X	6	GEH-5314	GEH-5314	STDA1X
NEMA Type 4/4X	10	GEH-5314	GEH-5314	STDA2X

Operating Mechanism Selection

Disconnect Description	QMR/QMW/ Flange Handle Product Number	Operating Mechanism Installation Instruction No.	Product Number
30-100A unfused; 30A-250V fused	STDA1, 1X or STDA2, 2X	GEH-5315	TDOM1A
30-100A 600V fused; 60A & 100A 250V fused	STDA1, 1X or STDA2, 2X	GEH-5315	TDOM1B
200A fused or unfused	STDA1, 1X or STDA2, 2X	GEH-5316	TDOM2

Select individual QMR or QMW disconnect and fuse or no-fuse kit from page 9-24.



Disconnect Switches and Operating Mechanisms Accessories and Modifications

For Type STDA Flange Handles and Operating Mechanisms

Section 9

Auxiliary Contact Kit

Available SPDT and DPDT and actuated by operating mechanism yoke.

Contacts	Used With Operating Mechanism Product Number	When TDA handle is on Right Flange	When TDA handle is on Left Flange	Product Number
SPDT	TDOM1A, TDOM1B, TDOM2	•	–	TDAS1L1
SPDT	TDOM1A, TDOM1B, TDOM2	–	•	TDAS1R1
DPDT	TDOM1A, TDOM1B, TDOM2	•	–	TDAS1L2
DPDT	TDOM1A, TDOM1B, TDOM2	–	•	TDAS1R2

Auxiliary Contact Electrical Ratings

Type	AC Voltage				DC Voltage Double Throw		
	120	240	480	600	120	240	600
1-Pole							
Make	40	20	20	8	0.5	0.2	.02
Break	15	10	6	5	0.5	0.2	.02
2-Pole							
Make	30	15	8	6	0.2	0.1	–
Break	3	1.5	1	0.8	0.2	0.1	–

Flange Stiffener Kit, Extended Drive Rod

Provides rigid 3/8-inch diameter rod between STDA handle mounting surface (flange or center mullion) and operating mechanism when STDA handle would otherwise not be rigidly supported.

Rod length is 22 inches and may be cut to appropriate length. Also used as extended length drive rod when standard 16-inch rod is not long enough.

Used With Operating Mechanism Product Number	Product Number
TDOM1A, 1B, TDOM2	TDSR

Extended Drive Stud

This optional drive stud permits locating the operating mechanism 1 5/16 inches further to the left (when flange handle is on right side) or to the right (when handle is on left side) to accommodate specific mounting restrictions.

Used With Operating Mechanism Product Number	Product Number
TDOM1A, TDOM1B, TDOM2	TDS1

Door Hardware, NEMA 12/12 and 4/4X

Type TDV door hardware provides sealing and interlocking of 3/4-inch nominal door depth hinged on left or right. Interlocking design requires use of screwdriver to release. When used with STDA flange handle and operating mechanisms, disconnect or circuit breaker cannot be turned on unless door and door hardware have been closed. For noninterlocking type, one bracket in kit is not used. Use of third-point latch recommended for doors 40 inches or longer.

Accessory Type	Description	Product Number
Door Hardware-Left Hinged	NEMA 12/13 two-point interlocking door hardware kit	TDV1
Door Hardware-Left Hinged	NEMA 4/4X two-point interlocking door hardware kit	TDV1X
Door Hardware-Left Hinged	Third-point latch kit for above	TDV3
Door Hardware-Right Hinged	NEMA 12/13 two-point interlocking door hardware kit	TDV1L
Door Hardware-Right Hinged	Third-point latch kit for above	TDV3L

Agency Certifications

STDA accessories are UL Recognized Components, File E-36152, and UL Recognized to Canadian safety requirements under the Component Recognition Program of Underwriters Laboratories Inc.

Reference Publications

Door Hardware	GEH-5322
Auxiliary Contact Kit	GEH-5323
Flange Stiffener Kit or Extended-Length Drive Rod	GEH-5324
Extended Drive Stud	GEH-5325
Operating Mechanism:	
TDOM1A through TDOM1B	GEH-5315
TDOM2	GEH-5316



Overpack Kits

QMW disconnect switch, fuse kit with copper lugs, operating mechanism and STDA1 flange handle packed in a single carton.

QMW with Copper Lugs for Copper Cables Only and Class R Rejection Clips for Class R Fusing

Ampere Rating	Fuse Clip Rating (Ampere)	System Voltage	Fuse Kit Prod. No. (or No-Fuse Kit Prod. No.)	Variable Depth Operating Mechanism Prod. No.	Product Number
30A	No Fuse	No Fuse	THMC3200CL	TDOM1A	STDAD3NF
30A	30	250Vdc	THMC3121CLR	TDOM1A	STDAD332R
30A	30	600Vac	THMC3161CLR	TDOM1B	STDAD336R
60A	No Fuse	No Fuse	THMC3200CL	TDOM1A	STDAD6NF
60A	60	250Vdc	THMC3222CLR	TDOM1B	STDAD662R
60A	60	600Vac	THMC3262CLR	TDOM1B	STDAD666R
100A	No Fuse	No Fuse	THMC3300CL	TDOM1A	STDAD1NF
		250Vdc			
100A	100	600Vac	THMC3363CLR	TDOM1B	STDAD100R
200A	No Fuse	No Fuse	THMC3400CL	TDOM2	STDAD2NF
		250Vdc			
200A	200	600Vac	THMC3464CLR	TDOM2	STDAD200R

QMW with Copper Lugs for Copper Cables Only and Class J Clips for Class J Fusing

Ampere Rating	Fuse Clip Rating (Ampere)	System Voltage	Fuse Kit Prod. No. (or No-Fuse Kit Prod. No.)	Variable Depth Operating Mechanism Prod. No.	Product Number
30A	30	600Vac	THMC3161CL	TDOM1JA	STDAD336J
30A	60	600Vac	THMC3262CL	TDOM1JB	STDAD3362J
60A	60	600Vac	THMC3262CL	TDOM1JB	STDAD666J
60A	100	600Vac	THMC3363CL	TDOM1JA	STDAD6663J
100A	100	600Vac	THMC3363CL	TDOM1JA	STDAD106J
100A	200	600Vac	THMC3364CL	TDOM1A	STDAD1064J
200A	200	600Vac	THMC3464CL	TDOM2	STDAD206J
200A	400	600Vac	THMC3465	TDOM2	STDAD2065J



Disconnect Switches and Operating Mechanisms

Section 9

General-Duty HCI

Individual Components

30-200 Amperes

240, 480, 600 Vac, 250 Vdc

Fuse Clip and No Fuse Kits — Horsepower Ratings

For Basic Switches with 600 Volt Industrial Control and 250 Volt Enclosed Switch and Switchboard Clearance Spacings

Basic Switch Rating	HP Rating, AC, 3-Phase, NEC Standard @ 240Vac	HP Rating, AC, 3-Phase, NEC Standard @ 480Vac	HP Rating, AC, 3-Phase, NEC Standard @ 600Vac	HP Rating, AC, 3-Phase, Time-Delay Fuse @ 240Vac	HP Rating, AC, 3-Phase, Time-Delay Fuse @ 480Vac	HP Rating, AC, 3-Phase, Time-Delay Fuse @ 600Vac	HP Rating, 250Vdc	Product Number
30 Ampere 3-Pole	-	-	-	7.5	15	20	5	THC3100 ^{1,3}
30 Ampere 3-Pole	3	-	-	7.5	-	-	5	THC3121
30 Ampere 3-Pole	-	5	7.5	-	15	20	-	THC3161
30 Ampere 3-Pole	-	5	7.5	-	15	20	-	THC31J1
30 Ampere 3-Pole	7.5	-	-	-	-	-	-	THC3122
30 Ampere 3-Pole	-	15	15	-	-	-	-	THC3162
30 Ampere 3-Pole	-	15	15	-	-	-	-	THC31J2
60 Ampere 3-Pole	-	-	-	15	30	50	10	THC3200 ²
60 Ampere 3-Pole	3	-	-	-	-	-	10	THC3221 ²
60 Ampere 3-Pole	-	5	7.5	-	-	-	-	THC3261 ²
60 Ampere 3-Pole	7.5	-	-	15	-	-	-	THC3222 ²
60 Ampere 3-Pole	-	15	15	-	30	50	-	THC3262 ²
60 Ampere 3-Pole	-	15	15	-	30	50	-	THC32J2 ²
60 Ampere 3-Pole	15	-	-	-	-	-	-	THC3223 ²
60 Ampere 3-Pole	-	25	30	-	-	-	-	THC3263 ²
60 Ampere 3-Pole	-	25	30	-	-	-	-	THC32J3 ²
100 Ampere 3-Pole	-	-	-	30	60	75	20	THC3300
100 Ampere 3-Pole	7.5	-	-	-	-	-	20	THC3322
100 Ampere 3-Pole	-	15	15	-	-	-	-	THC3362
100 Ampere 3-Pole	15	-	-	30	-	-	-	THC3323
100 Ampere 3-Pole	-	25	30	-	60	75	-	THC3363
100 Ampere 3-Pole	-	25	30	-	60	75	-	THC33J3
100 Ampere 3-Pole	25	-	-	-	-	-	-	THC3324
100 Ampere 3-Pole	-	50	60	-	-	-	-	THC3364
100 Ampere 3-Pole	-	50	60	-	-	-	-	THC33J4
200 Ampere 3-Pole	-	-	-	60	100	100	40	THC3400
200 Ampere 3-Pole	15	-	-	-	-	-	40	THC3423
200 Ampere 3-Pole	-	25	30	-	-	-	-	THC3463
200 Ampere 3-Pole	-	25	30	-	-	-	-	THC34J3
200 Ampere 3-Pole	25	-	-	60	-	-	-	THC3424
200 Ampere 3-Pole	-	50	60	-	100	100	-	THC3464
200 Ampere 3-Pole	-	50	60	-	100	100	-	THC34J4
200 Ampere 3-Pole	50	-	-	-	-	-	-	THC3425
200 Ampere 3-Pole	-	100	100	-	-	-	-	THC3465
200 Ampere 3-Pole	-	100	100	-	-	-	-	THC34J5

Fuse and No-Fuse Kits — Horsepower Ratings

For Basic Switches with 600 Volt Enclosed Switch and Switchboard Clearance Spacings

Basic Switch Rating	HP Rating, AC, 3-Phase, NEC Standard @ 240Vac	HP Rating, AC, 3-Phase, NEC Standard @ 480Vac	HP Rating, AC, 3-Phase, NEC Standard @ 600Vac	HP Rating, AC, 3-Phase, Time-Delay Fuse @ 240Vac	HP Rating, AC, 3-Phase, Time-Delay Fuse @ 480Vac	HP Rating, AC, 3-Phase, Time-Delay Fuse @ 600Vac	HP Rating, 250Vdc	Product Number
30 Ampere 3-Pole	3	5	7.5	-	15	20	5	THC31S61 ^{1,3}
30 Ampere 3-Pole	3	5	7.5	-	15	20	5	THC31SJ1 ^{1,3}
30 Ampere 3-Pole	-	-	-	7.5	15	20	5	THC3100 ^{1,3}
60 Ampere 3-Pole	7.5	15	15	-	30	50	10	THC32S62
60 Ampere 3-Pole	7.5	15	15	-	30	50	10	THC32SJ2
60 Ampere 3-Pole	-	-	-	15	30	50	10	THC3200 ²
100 Ampere 3-Pole	-	25	30	-	60	75	-	THC3363
100 Ampere 3-Pole	-	25	30	-	60	75	-	THC33J3
100 Ampere 3-Pole	-	-	-	30	60	75	20	THC3300
200 Ampere 3-Pole	-	50	60	-	100	100	-	THC3464
200 Ampere 3-Pole	-	50	60	-	100	100	-	THC34J4
200 Ampere 3-Pole	-	-	-	60	100	100	40	THC3400

Auxiliary switch (SPDT) for HCI rated .5 ampere at 125Vdc, .25 ampere at 250Vdc, 15 ampere at 480Vac. Product Number 343L296G2.

HCI switches, fuse and no-fuse kits, are listed in UL "Recognized Component Index" (WHTY2) for mounting in a vertical position, line side up. UL File E-36152.

Line shield included with THC31 and THC31S. All other line shields included with fuse-clip or no-fuse kits.

For **Two-pole applications**—Use two poles of three-pole switch.

HCI switches, fuse and no-fuse kits, are listed in UL "Recognized Component Index" (WHTY2) for mounting in a vertical position, line side up. UL File E-36152.

Inside enclosure depth may be reduced to these depths while maintaining electrical spacings—requires cutting handle shaft.

¹Suitable for 25 hp @ 600 V but not UL listed.

²Basic switch with UL 600 Volt industrial control spacings only.

³For 30 ampere switch with 600 Volt enclosed switch spacing and 60 ampere terminals, order Product Number THC31SSE.



Disconnect Switches and Operating Mechanisms

General-Duty HCI (continued)

Section 9

Individual Components

30-200 Amperes

240, 480, 600 Vac, 250 Vdc

Fuse Clip and No Fuse Kits

For Basic Switches with 600 Volt Industrial Control and 250 Volt Enclosed Switch and Switchboard Clearance Spacings.

Basic Switch Rating	Basic Switch Product Number	Fuse Type	Fuse Kit Rating	Product Number
30 Ampere 3-Pole	THC31S	No Fuse	No Fuse—600	THC3100 ^{1,3}
30 Ampere 3-Pole	THC31	NEC Standard	30A, 240Vac/250Vdc	THC3121
30 Ampere 3-Pole	THC31	NEC Standard	30A, 600Vac	THC3161
30 Ampere 3-Pole	THC31	Class J	30A, 600Vac	THC31J1
30 Ampere 3-Pole	THC31	NEC Standard	60A, 240Vac/250Vdc	THC3122
30 Ampere 3-Pole	THC31	NEC Standard	60A, 600Vac	THC3162
30 Ampere 3-Pole	THC31	Class J	60A, 600Vac	THC31J2
60 Ampere 3-Pole	THC32S	No Fuse	No Fuse—600	THC3200 ²
60 Ampere 3-Pole	THC32	NEC Standard	30A, 240Vac/250Vdc	THC3221 ²
60 Ampere 3-Pole	THC32	NEC Standard	30A, 600Vac	THC3261 ²
60 Ampere 3-Pole	THC32	NEC Standard	60A, 240Vac/250Vdc	THC3222 ²
60 Ampere 3-Pole	THC32	NEC Standard	60A, 600Vac	THC3262 ²
60 Ampere 3-Pole	THC32	Class J	60A, 600Vac	THC32J2 ²
60 Ampere 3-Pole	THC32	NEC Standard	100A, 240Vac/250Vdc	THC3223 ²
60 Ampere 3-Pole	THC32	NEC Standard	100A, 600Vac	THC3263 ²
60 Ampere 3-Pole	THC32	Class J	100A, 600Vac	THC32J3 ²
100 Ampere 3-Pole	THC33S	No Fuse	No Fuse—600	THC3300
100 Ampere 3-Pole	THC33	NEC Standard	60A, 240Vac/250Vdc	THC3322
100 Ampere 3-Pole	THC33	NEC Standard	60A, 600Vac	THC3362
100 Ampere 3-Pole	THC33	NEC Standard	100A, 240Vac/250Vdc	THC3323
100 Ampere 3-Pole	THC33S	NEC Standard	100A, 600Vac	THC3363
100 Ampere 3-Pole	THC33S	Class J	100A, 600Vac	THC33J3
100 Ampere 3-Pole	THC33	NEC Standard	200A, 240Vac/250Vdc	THC3324
100 Ampere 3-Pole	THC33	NEC Standard	200A, 600Vac	THC3364
100 Ampere 3-Pole	THC33	Class J	200A, 600Vac	THC33J4
200 Ampere 3-Pole	THC34S	No Fuse	No Fuse—600	THC3400
200 Ampere 3-Pole	THC34	NEC Standard	100A, 240Vac/250Vdc	THC3423
200 Ampere 3-Pole	THC34	NEC Standard	100A, 600Vac	THC3463
200 Ampere 3-Pole	THC34	Class J	100A, 600Vac	THC34J3
200 Ampere 3-Pole	THC34	NEC Standard	200A, 240Vac/250Vdc	THC3424
200 Ampere 3-Pole	THC34	NEC Standard	200A, 600Vac	THC3464
200 Ampere 3-Pole	THC34	Class J	200A, 600Vac	THC34J4
200 Ampere 3-Pole	THC34	NEC Standard	400A, 240Vac/250Vdc	THC3425
200 Ampere 3-Pole	THC34	NEC Standard	400A, 600Vac	THC3465
200 Ampere 3-Pole	THC34	Class J	400A, 600Vac	THC34J5

Fuse Clip and No Fuse Kits

For Basic Switches with 600 Volt Enclosed Switch and Switchboard Clearance Spacings.

Basic Switch Rating	Basic Switch Product Number	Fuse Type	Fuse Kit Rating	Product Number
30 Ampere 3-Pole	THC31S	NEC Standard	30A, 600Vac	THC31S61 ^{1,3}
30 Ampere 3-Pole	THC31S	Class J	30A, 600Vac	THC31SJ1 ^{1,3}
30 Ampere 3-Pole	THC31S	No Fuse	No Fuse—600	THC3100 ^{1,3}
60 Ampere 3-Pole	THC32S	NEC Standard	60A, 600Vac	THC32S62
60 Ampere 3-Pole	THC32S	Class J	60A, 600Vac	THC32SJ2
60 Ampere 3-Pole	THC32S	No Fuse	No Fuse—600	THC3200 ²
100 Ampere 3-Pole	THC33S	NEC Standard	100A, 600Vac	THC3363
100 Ampere 3-Pole	THC33S	Class J	100A, 600Vac	THC33J3
100 Ampere 3-Pole	THC33S	No Fuse	No Fuse—600	THC3300
200 Ampere 3-Pole	THC34	NEC Standard	200A, 600Vac	THC3464
200 Ampere 3-Pole	THC34	Class J	200A, 600Vac	THC34J4
200 Ampere 3-Pole	THC34S	No Fuse	No Fuse—600	THC3400

Auxiliary switch (SPDT) for HCI rated .5 ampere at 125Vdc, .25 ampere at 250Vdc, 15 ampere at 480Vac. Product Number 343L296G2.

HCI switches, fuse and no-fuse kits, are listed in UL "Recognized Component Index" (WHTY2) for mounting in a vertical position, line side up. UL File E-36152.

Line shield included with THC31 and THC31S. All other line shields included with fuse-clip or no-fuse kits.

For **Two-pole applications**—Use two poles of three-pole switch.

HCI switches, fuse and no-fuse kits, are listed in UL "Recognized Component Index" (WHTY2) for mounting in a vertical position, line side up. UL File E-36152.

Inside enclosure depth may be reduced to these depths while maintaining electrical spacings—requires cutting handle shaft.

¹Suitable for 25 hp @ 600 V but not UL listed.

²Basic switch with UL 600 Volt industrial control spacings only.

³For 30 ampere switch with 600 Volt enclosed switch spacing and 60 ampere terminals, order Product Number THC31SSE.



TDR Integral Handle Mechanism for QMR/QMW Disconnects

- Rotary operating handle mounts directly to disconnect.
- Operates through enclosure door—mechanical interlock designed to prevent unauthorized opening of enclosure when disconnect is ON.
- Locking hasp accommodates up to three padlocks.
- Suitable for use with NEMA 1, 12, and 12K enclosures.
- UL Recognized Components, File E-36152.



TDR Handle

Integral Handles (Separate Kits for Field Assembly)

Accessory Type	Ampere Rating	Add to Switch Product No. Suffix for Factory Assembly	Product Number
Integral Handle, Vertical	30A, 60A, 100A	V1	THMR1B
Integral Handle, Vertical	200A	V2	THMR2B
Integral Handle, Horizontal	30A, 60A, 100A	H1	THMR1HB
Integral Handle, Horizontal	200A	H1	THMR2HB
Door ring interlock	-	-	SEFRDRCK
Gasket kit	-	-	SEFRGSK

Auxiliary Switches (Separate Kits for Field Assembly)

Accessory Type	Ampere Rating	Add to Integral Handle Product No. Suffix for Factory Installation	Product Number
Auxiliary Switch	100	AS1	343L492G1
Auxiliary Switch	200	AS2	343L492G2



Disconnect Switches and Operating Mechanisms

FD1 Fusible IEC Style

Section 9

Individual Components

600 Vac

250 Vdc



FD130CC

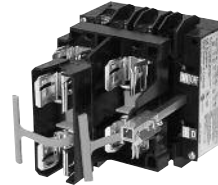

FD130J



FD130NF



FD160J



FD160NF

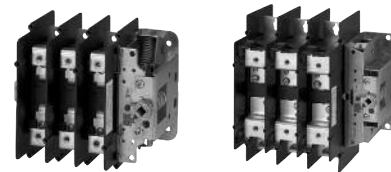

FD1100J and FD1200J

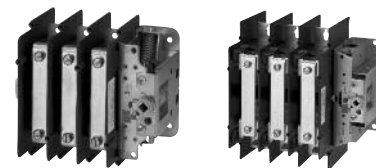

FD1100NF and FD1200NF

Horsepower Ratings (Time Delay)

Fuse Operating Characteristics

Product Number	Maximum HP, 3-Phase AC @ 240Vac, 60Hz, Time Delay	Maximum HP, 3-Phase AC @ 480Vac, 60Hz, Time Delay	Maximum HP, 3-Phase AC @ 600Vac, 60Hz, Time Delay	Maximum HP, Single-Phase AC @ 120Vac, 60Hz, Time Delay	Maximum HP, Single-Phase AC @ 240Vac, 60Hz, Time Delay	Maximum HP, DC @ 125Vdc, Time Delay	Maximum HP, DC @ 250Vdc, Time Delay
FD130CC	5	10	10	0.75	2	2	3
FD130J	7.5	15	20	2	3	3	5
FD130NF	7.5	15	20	2	3	3	5
FD160J	15	30	50	3	10	5	10
FD160NF	15	30	50	3	10	5	10
FD1100J	30	60	75	-	15	-	20
FD1100NF	30	60	75	-	15	-	20
FD1200J	60	125	150	-	25	-	40
FD1200NF	60	125	150	-	25	-	40

Horsepower Ratings (Non-Time Delay)

Fuse Operating Characteristics

Product Number	Maximum HP, 3-Phase AC @ 240Vac, 60Hz, Non-Time Delay	Maximum HP, 3-Phase AC @ 480Vac, 60Hz, Non-Time Delay	Maximum HP, 3-Phase AC @ 600Vac, 60Hz, Non-Time Delay	Maximum HP, Single-Phase AC @ 120Vac, 60Hz, Non-Time Delay	Maximum HP, Single-Phase AC @ 240Vac, 60Hz, Non-Time Delay	Maximum HP, DC @ 125Vdc, Non-Time Delay	Maximum HP, DC @ 250Vdc, Non-Time Delay
FD130CC	5	10	10	0.75	2	2	3
FD130J	3	5	7.5	0.5	1.5	2	5
FD130NF	3	5	7.5	0.5	1.5	2	5
FD160J	7.5	15	15	1.5	3	5	5
FD160NF	7.5	15	15	1.5	3	5	5
FD1100J	15	25	30	-	7.5	-	20
FD1100NF	15	25	30	-	7.5	-	20
FD1200J	25	50	60	-	15	-	40
FD1200NF	25	50	60	-	15	-	40

IEC Disconnects — Fuse Specification

Ampere Rating	Fuse Type	Maximum Fuse Cartridge Size	Maximum Voltage	Maximum Available Fault Current	Product Number
30A	Class CC HRCl-MISC	30 A	600Vac/250Vac	100 kA	FD130CC ²
30A	Class J HRCl-J	30 A	600Vac/250Vac	100 kA	FD130J
30A	Non-Fused	30 A	600Vac/250Vac	100 kA	FD130NF ^{1,2}
60A	Class J HRCl-J	60 A	600Vac/250Vac	100 kA	FD160J
60A	Non-Fused	60 A	600Vac/250Vac	100 kA	FD160NF ^{1,2}
100A	Class J HRCl-J	100	600Vac/250Vac	100 kA	FD1100J
100A	Non-Fused	Non-Fused	600Vac/250Vac	100 kA	FD1100NF ^{1,2}
200A	Class J HRCl-J	200	600Vac/250Vac	100 kA	FD1200J
200A	Non-Fused	Non-Fused	600Vac/250Vac	100 kA	FD1200NF ^{1,2}

¹Non-fused disconnect switches must be used with separately installed UL Listed class J, CC or T fuses; or CSA Certified HRCl-J, HRCl-T or HRCl-MISC.

²CSA HRCl-MISC fuses must also be UL Listed as class CC fuses.

Mechanical Specifications³

Product Number	Mechanical Endurance Operations	Normal Operating Torque	Terminal Capacity / Power Terminals	Terminal Capacity / Auxiliary Switch Terminals	Maximum Number of Auxiliary Circuits
FD130CC	10000	27	#14 - #8	#14 - #12	4
FD130J	10000	27	#14 - #8	#14 - #12	4
FD130NF	10000	27	#14 - #8	#14 - #12	4
FD160J	10000	45	#14 - #4	#14 - #12	4
FD160NF ¹	10000	45	#14 - #4	#14 - #12	4
FD1100J	10000	107	#14 - #2	#14 - #12	4
FD1100NF	10000	107	#14 - #2	#14 - #12	4
FD1200J	10000	239	#6 - 250kcmil	#14 - #12	4
FD1200NF	10000	239	#6 - 250kcmil	#14 - #12	4

³See page 9-38 for additional Mechanical Specifications.



Disconnect Switches and Operating Mechanisms

FD1 Fusible IEC Style

Accessories

Section 9

Door Mounted Rotary Operating Handles NEMA Type 1/12/4/4X (IP65)

Switch Type	Color	Comments	Product Number
FD130 or FD160	Black	NEMA 4, 4X, with defeat to enable panel entry while power on.	FD1HA4XB
FD130 or FD160	Red/Yellow	NEMA 4, 4X, with defeat to enable panel entry while power on.	FD1HA4XRY
FD1100 or FD1200	Black	NEMA 3R, simple on/off pistol grip handle	FD11HA1B
FD1100 or FD1200	Red/Yellow	NEMA 3R, simple on/off pistol grip handle	FD11HA1RY
FD1100 or FD1200	Black	NEMA 3R, on/off with lock-out tag-out pistol grip handle	FD11HA4B
FD1100 or FD1200	Red/Yellow	NEMA 3R, on/off with lock-out tag-out pistol grip handle	FD11HA4RY
FD1100 or FD1200	Black	NEMA 3R, on/off with lock-out tag-out and defeatable pistol grip handle	FD11HA3B
FD1100 or FD1200	Red/Yellow	NEMA 3R, on/off with lock-out tag-out and defeatable pistol grip handle	FD11HA3RY

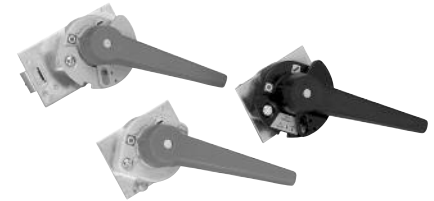

Pistol Grip Operating Handle



Rotary Operating Handle

Operating Shafts

Switch Type	Handle Type	Enclosure Depth (Max.)	Shaft Length	Product Number
FD130 or FD160	FD1HA4X	10 15/64 (260)	166mm or 6 17/32in.	FD1S166
FD130 or FD160	FD1HA4X	17 7/8 (454)	360mm or 14 11/64in.	FD1S360
FD1100 or FD1200	FD11HA	11 21/38 (296)	200mm or 7 7/8in.	FD1S12
FD1100 or FD1200	FD11HA	16 15/64 (430)	319mm or 12 19/32in.	FD1L12



Operating Shafts

Auxiliary Switches

Switch Type	Description	Contact Configuration	Location	Product Number
FD130, FD160, FD1100 or FD1200	SPDT	NO	First	FD1ASNO1
FD130, FD160, FD1100 or FD1200	SPDT	NC	First	FD1ASNC1
FD130, FD160, FD1100 or FD1200	SPDT	NO	Second	FD1ASNO2
FD130, FD160, FD1100 or FD1200	DPDT	2 NO	First	FD1ASNO11
FD130, FD160, FD1100 or FD1200	DPDT	2 NC	First	FD1ASNC11
FD130, FD160, FD1100 or FD1200	DPDT	2 NO	Second	FD1ASNO22

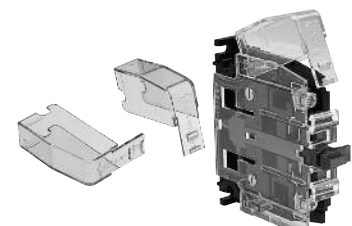

Auxiliary Switch with Terminal Shields



Accessories

Other Accessories

Accessory Type	Switch Type	Comments	Product Number
Terminal Shields	FD130	Terminal shield for line or load side. One shield supplied with switch as standard.	FD130TS
Terminal Shields	FD160	Terminal shield for line or load side. One shield supplied with switch as standard.	FD160TS
Terminal Shields	FD1100	Terminal shield for line or load side. One shield supplied with switch as standard.	FD1100TS
Terminal Shields	FD1200	Terminal shield for line or load side. One shield supplied with switch as standard.	FD1200TS
Shorting Links	FD130	Package of 3. Use as replacements in FD130NF and FD160NF.	FD130LNK
Shorting Links	FD160	Package of 3. Use as replacements in FD130NF and FD160NF.	FD160LNK
Shorting Links	FD1100	For non-fused applications.	FD1100LNK
Shorting Links	FD1200	For non-fused applications.	FD1200LNK
Fuse Covers	FD130CC	-	FD130CV1
Fuse Covers	FD130J	-	FD130JCV1
Fuse Covers	FD160J	-	FD160JCV1
Fuse Covers	FD160NF	-	FD160NF
Fuse Covers	FD1100	-	FD1100JCV1
Fuse Covers	FD1200	-	FD1200JCV1
Auxiliary Switch	All	Package of 2.	FD1ASCV1
Terminal Shields			



Terminal Shields

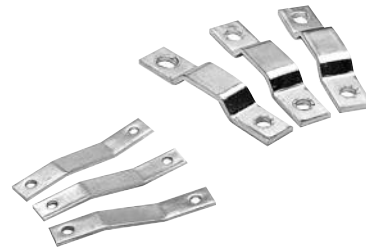

Shorting Links

Lug Kits

Type	Description	Product Number
100A	3 mech conn.	FD1LK1
200A	3 mech conn.	FD1LK2

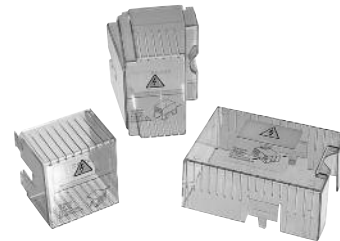

Fuse Covers



Lugs Kits



Disconnect Switches and Operating Mechanisms

FD1 Fusible IEC Style

Outlines and Dimensions

Section 9

Type FD1 Dimension References - in. (mm)

Product Number	Dimension A	Dimension B	Dimension C	Dimension D	Dimension E	Dimension F
FD130CC	4 19/64 (109)	3 23/64 (85)	4 21/64 (110)	3 15/64 (82)	4 13/32 (112)	M4
FD130J	4 19/64 (109)	3 11/32 (85)	4 21/64 (110)	3 15/64 (82)	5 15/64 (133)	M4
FD130NF	4 19/64 (109)	3 23/64 (85)	4 21/64 (110)	3 15/64 (82)	4 13/32 (112)	M4
FD160J	4 41/64 (118)	4 23/32 (120)	5 19/32 (142)	3 15/16 (100)	4 49/64 (121)	M4
FD160NF	4 41/64 (118)	4 23/32 (120)	5 19/32 (142)	3 15/16 (100)	4 49/64 (121)	M4
FD1100J	6 21/32 (169)	6 7/32 (158)	7 11/64 (182)	4 9/64 (105)	4 59/64 (125)	M6
FD1100NF	6 21/32 (169)	6 7/32 (158)	7 11/64 (182)	4 9/64 (105)	4 59/64 (125)	M6
FD1200J	9 27/32 (250)	8 21/32 (220)	9 17/32 (242)	5 29/32 (150)	7 (178)	M8
FD1200NF	9 27/32 (250)	8 21/32 (220)	9 17/32 (242)	5 29/32 (150)	7 (178)	M8

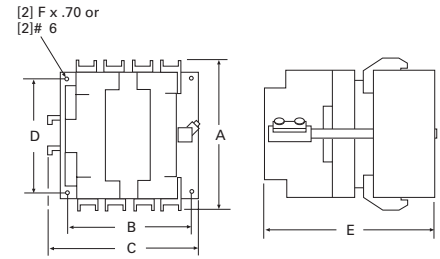

Type FD1 – Additional Mechanical Specifications

Product Number	Approx. Net Weight (Lbs.)	Minimum Enclosure Size - Height (in.)	Minimum Enclosure Size - Width	Minimum Enclosure Size - Depth
FD130CC	2.03	9.875	6.875	6.375
FD130J	2.03	9.875	6.875	6.375
FD130NF	1.78	9.875	6.875	6.375
FD160J	2.90	9.875	7.875	6.375
FD160NF	2.52	9.875	7.875	6.375
FD1100J	6.87	15.75	11.50	7.75
FD1100NF	6.82	15.75	11.50	7.75
FD1200J	15.84	15.75	11.50	7.75
FD1200NF	16.39	15.75	11.50	7.75

Type FD1

Approvals/Standards

UL Listed (UL 489)
 CSA Certified (CSA 22.2 No. 4)
 Meets service entrance requirements
 CE Marked



Disconnect Switches and Operating Mechanisms

DILOS Nonfusible Vu-Break IEC Style

Section 9

Individual Components
480 Vac

IEC Disconnects – Non Fused

Ampere Rating	No. of Poles	Horsepower 460 Vac	Horsepower 230 Vac	Product Number
30A	3	10	5	D/061312-201
60A	3	15	7.5	D/061314-201
80A	3	20	10	D/061315-201
100A	3	25	15	D/061324-201
125A	3	30	15	D/061326-201

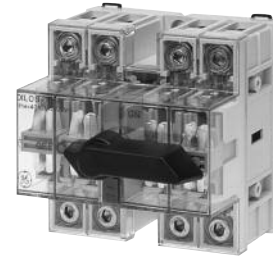

DILOS 1

Ratings Per IEC 947-3

Product Number	Rated Current at 40° C	Rated Current at 50° C	Rated Current at 60° C	Terminal Capacity (CU)	Rated operational voltage Ue
D/061312-201	40 A	40 A	40 A	6 mm ² Min. 50 mm ² Max.	690 V
D/061314-201	63 A	63 A	63 A	6 mm ² Min. 50 mm ² Max.	690 V
D/061315-201	80 A	80 A	80 A	6 mm ² Min. 50 mm ² Max.	690 V
D/061324-201	160 A	160 A	160 A	Copper bus maximum 6 x 20mm	690 V
D/061326-201	200 A	200 A	200 A	Copper bus maximum 6 x 20mm	690 V



DILOS 2

Ratings Per IEC 947-3 (Continued)

Product Number	Rated Insulation Voltage Ui	Rated Impulse Voltage Uimp	Impulse Test Voltage at Sea Level	Rated Operation Current Ie @ Utilization AC21A at Ue=415V	Rated Operation Current Ie @ Utilization AC22a at Ue=415V	Rated Operation Current Ie @ Utilization AC23A at Ue=415V
D/061312-201	690 V	8 kV	12.3 kV	40 A	40 A	40 A
D/061314-201	690 V	8 kV	12.3 kV	63 A	63 A	50 A
D/061315-201	690 V	8 kV	12.3 kV	80 A	80 A	80 A
D/061324-201	690 V	8 kV	12.3 kV	160 A	160 A	125 A
D/061326-201	690 V	8 kV	12.3 kV	200 A	200 A	160 A

Ratings Per IEC 947-3 (Continued)

Product	Rated Short-time Withstand Current Icw, 1 sec.	Rated Short-time Withstand Current Icw, 0.25 sec.	Peak Short-Circuit Withstand Current	Rated Short-circuit Making Capacity Icm, Ue=400V	Rated Short-circuit Making Capacity Icm, Ue=415V
D/061312-201	3 kA rms	6 kA rms	10 kA rms	10 kA	10 kA
D/061314-201	3 kA rms	6 kA rms	10 kA rms	10 kA	10 kA
D/061315-201	3 kA rms	6 kA rms	10 kA rms	10 kA	10 kA
D/061324-201	3 kA rms	6 kA rms	10 kA rms	10 kA	10 kA
D/061326-201	3 kA rms	6 kA rms	10 kA rms	10 kA	10 kA

Ratings Per IEC 947-3 (Continued)

Product Number	Rated Conditional Short-Circuit Withstand Current @ 400V	Rated Conditional Short-Circuit Withstand Current @ 415V	Rated Operational Current DC23A (2P Series) @ 110V	Rated Operational Current DC23A (2P Series) @ 220V	Electrical Durability	Mechanical Durability
D/061312-201	50 kA rms	50 kA rms	40 A	40 A	1500 Cycles	20000 Cycles
D/061314-201	50 kA rms	50 kA rms	63 A	63 A	1500 Cycles	20000 Cycles
D/061315-201	50 kA rms	50 kA rms	80 A	-	1500 Cycles	20000 Cycles
D/061324-201	50 kA rms	50 kA rms	160 A	100 A	1000 Cycles	10000 Cycles
D/061326-201	50 kA rms	50 kA rms	160 A	100 A	1000 Cycles	10000 Cycles



Disconnect Switches and Operating Mechanisms

DILOS Nonfusible Vu-Break IEC Style

Section 9

Accessories

Auxiliary Switches

No. of Poles	Comments	Product Number
1	Adds 9mm to width of switch.	D/061901-001
2	Adds 9mm to width of switch.	D/061901-002

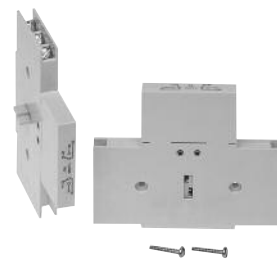

Auxiliary Switches

Padlocking Device

Comments	Product Number
For padlock with maximum 8mm or 5/16" diameter.	D/061900-020



Padlocking Device

Inbus Key

Shaft Length	Comments	Product Number
200mm	S5 Insulated	D/061000-097



Inbus Key

Operating Handle with Extension Shaft – NEMA 1/12

Shaft Length	Handle Color	Product Number
200mm	Black	D/061910-002
200mm	Red/Yellow	D/061910-012
400mm	Black	D/061910-004
400mm	Red/Yellow	D/061910-014



Operating Handle with Extension Shaft

Lugs

Wire Size	Comments	Product Number
#8-250 kcmil CU	Package of 3	D/061922-003

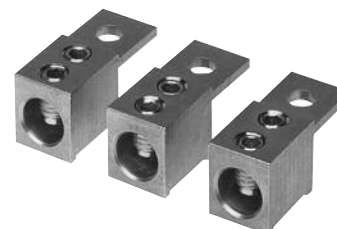

Lugs



Disconnect Switches and Operating Mechanisms

DILOS Nonfusible Vu-Break IEC Style

Section 9

Outlines and Dimensions

DILOS – Weights

Product Number	Weight (Lbs.)	Weight (kg)
D/061312-201	1.2	0.54 kg
D/061314-201	1.2	0.54 kg
D/061315-201	1.2	0.54 kg
D/061324-201	1.6	0.73 kg
D/061326-201	1.6	0.73 kg

Approvals/Standards

UL Listed (UL 489)
IEC 947-1, 947-3
EN 60947-3

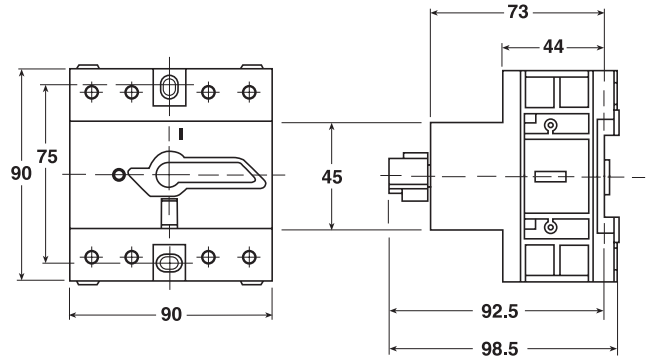

DILOS 1

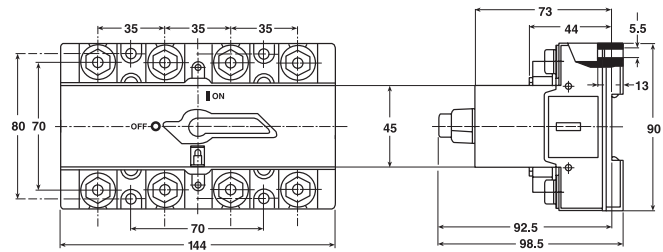

DILOS 2

