

# Load Centers and Circuit Breakers

## Section 1

Q-Line Circuit Breakers– Product Features and Benefits.....	1-2
PowerMark Gold Load Centers—	
Product Features and Benefits .....	1-3
PowerMark Gold and Plus Load Centers—	
Product Number Guides.....	1-4
Q-Line Plug-in Circuit Breakers.....	1-5
Special Purpose Circuit Breakers.....	1-6
PowerMark Gold and Plus Single-Phase Load Centers—	
Main Lug Convertible to Main Breaker.....	1-9
Main Breaker Factory Installed .....	1-12
PowerMark Plus™ Three-Phase Load Centers—	
Main Circuit Breakers or Main Lugs Factory Installed .....	1-14
PowerMark Gold Load Centers—Specialty Panels.....	1-17
PowerMark Gold Meter Socket Load Centers .....	1-18
Field Installed Accessories.....	1-24
Wiring Diagrams .....	1-30
Load Centers and Meter Socket Load Centers—	
Knockouts.....	1-37



# Load Centers and Circuit Breakers

## Q-Line Circuit Breakers

# Section 1

Reliability and Economy

### Special Purpose Circuit Breakers

- PowerMark Gold Main Circuit Breakers
- Arc Fault Circuit Interrupter
- CB3 Ground Fault Circuit Interrupter
- Switching Neutral
- HID Lighting Breaker
- High Magnetic Breaker
- Molded Case Switch
- Surge Arrester
- TQ Breaker

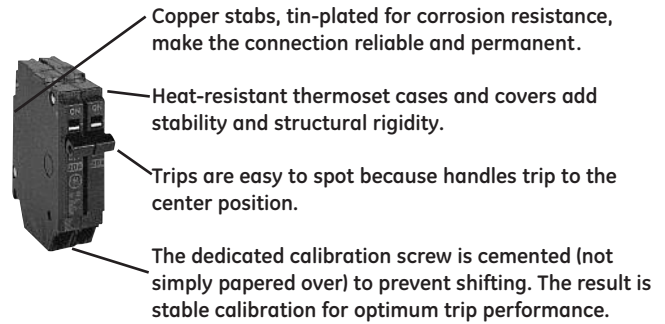

At 1/2", THQP breakers are half the width of standard breakers, permitting the use of smaller load centers that save money and space in both new construction and service upgrades. They feature the same high-performance design, and meet the same stringent standards as other Q-Line breakers. Our 1" THQL will remain the breaker of choice for many contractors. In applications where space and cost are not critical, they're an excellent choice. But when size and money are driving considerations, THQP breakers are the smart choice.

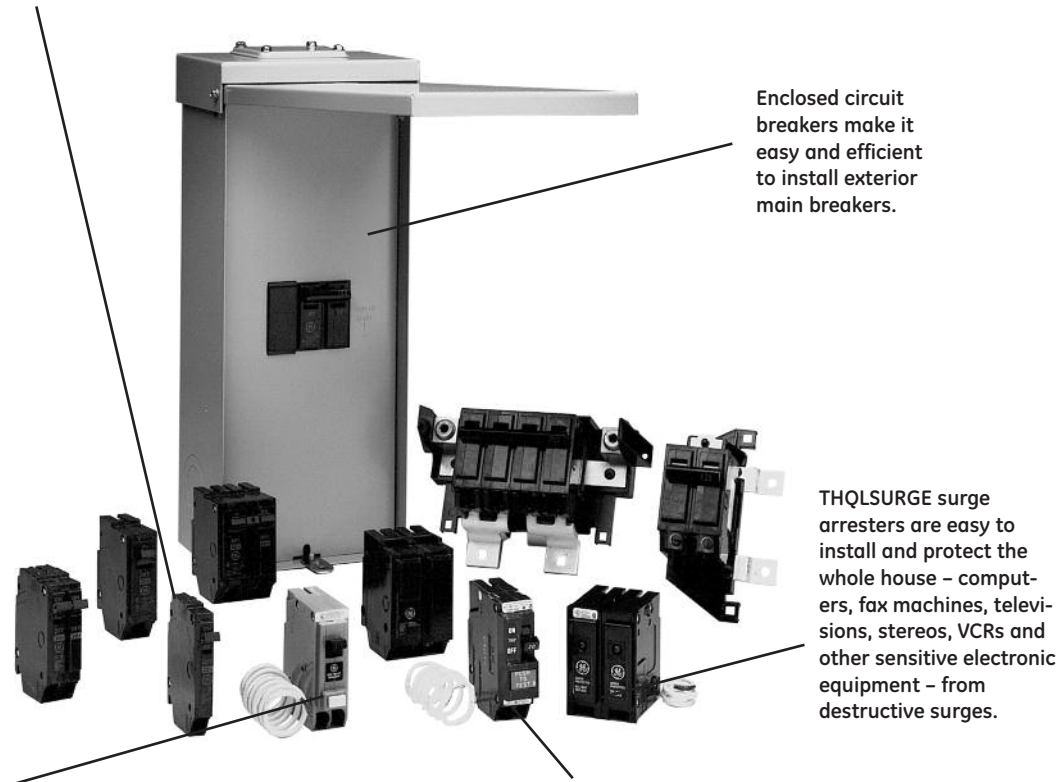

Enclosed circuit breakers make it easy and efficient to install exterior main breakers.

THQLSURGE surge arresters are easy to install and protect the whole house – computers, fax machines, televisions, stereos, VCRs and other sensitive electronic equipment – from destructive surges.

Maximum protection against all-too-common electrical fires comes from the new technology built into GE's arc fault circuit interrupters (AFCIs). With its ability to detect and interrupt arcing caused by damaged wire insulation or a frayed extension cord, the AFCI takes home and family protection to a new, higher level.

The NEC requires ground fault protection of receptacles outdoors and in garages, bathrooms and spa areas. These ground fault circuit interrupters eliminate the need for separate GFCI receptacles, protect against short circuits and overloads, and prevent shock by detecting very low levels of current leaks and immediately shutting off power to the circuit.



# Load Centers and Circuit Breakers

## PowerMark Gold Load Centers

Highest Quality and Convenience

## Section 1

PowerMark Gold load centers lower your costs by making installation faster and easier, increasing application flexibility and reducing inventory requirements. At the same time, they deliver obvious and significant advances in design, function and quality.

- UL Listed (Panelboards No. 67)
- Suitable for Use as Service Entrance Equipment when installed in accordance with National Electrical Code
- 60°C/75°C Conductor Rating
- Single phase, 40-225A, 2-42 circuits
- Main lug models field convertible to main breaker
- Main breaker 22kAIC standard - factory installed
- All load centers top or bottom feed
- Indoor and outdoor rated enclosures
- Indoor fronts combination surface/flush
- Copper bus with tin plating standard<sup>1</sup>
- Split neutrals extend the full length of the interior for ease of wiring
- Entire main lug line converts easily to main breaker
- Combination surface/flush front with spring-reinforced pan
- Combination slotted/Robertson square-drive screws on neutral,<sup>2</sup> ground, front and breaker lugs
- Front packed in inner carton for added protection
- Field installable feed-through lugs up to 200A
- Straight-through main wiring
- Main breaker is clearly marked and circuit numbers are stamped on front
- Isolated ground bar is available
- Compact box maintains optimum wire-bending space

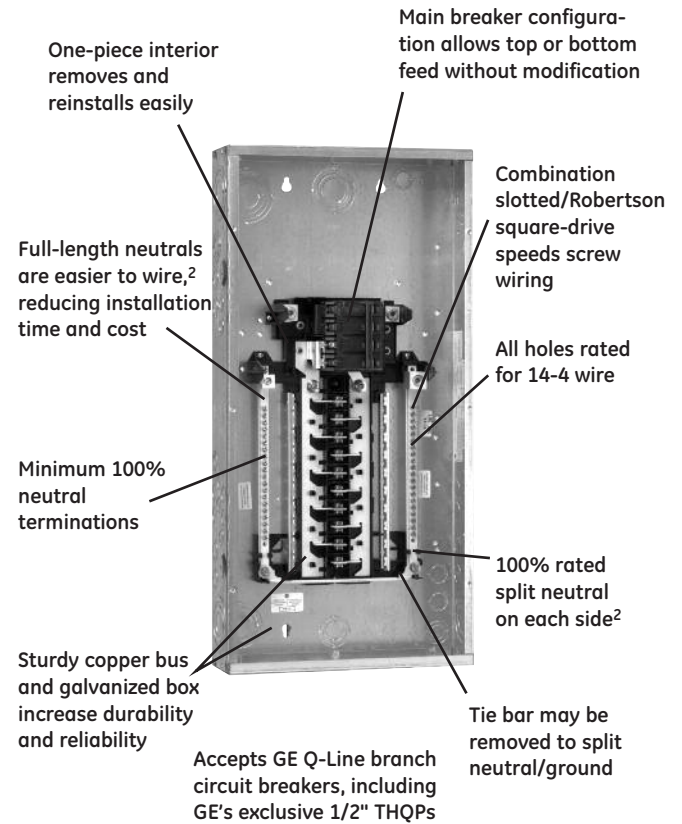

Packaging features comprehensive selection and application data. Fronts are packed in inner cartons for added protection during shipment and at the job site.



A complete family of meter socket load centers — ring style and ringless, wide and narrow, meter mains, farm panels and more — deliver specialized solutions for special situations.

The PowerMark Gold line includes a wide range of outdoor as well as indoor units.

Main lug load centers offer an economical solution for subpanels and similar applications. All main lug units 125A and above convert easily to main breaker.

GE's residential load centers reach into commercial applications as well, with riser panels, auxiliary gutters, three-phase units with standard 22kAIC ratings, and all the accessories needed to complete the job.

### Accessories and Options

- Door lock and handle
- Equipment ground kits
- Sub-feed and feed-thru lugs
- Front filler plates
- Handle lock and ties
- Hardware kits
- Main breaker retainers
- Neutral kits
- Universal raintight hubs

### Safety accessories – convenient and easy to install

- THQLSURGE whole house surge protector
- Arc fault circuit interrupter breaker, 1- or 2-pole
- Ground fault circuit interrupter breaker, 5mA and 30mA
- Generator transfer panel – 30A or 60A, indoor or outdoor
- GE AC disconnects

<sup>1</sup>Three-phase PowerMark Plus load centers have aluminum bus with copper breaker mounting stabs.

<sup>2</sup>16 circuit and above.



# Load Centers and Circuit Breakers

## PowerMark Gold and Plus Load Centers

# Section 1

### Product Number Guides

#### Product Number Guide for Load Centers

(Product number for illustrative purposes only)

<b>T</b>	<b>M</b>	<b>42</b>	<b>4</b>	<b>20</b>	<b>C</b>	<b>CU</b>	<b>B</b>
<b>GE Identification</b>							
<b>Type</b>							
M = Main breaker							
L = Main lug							
LM = Convertible							
PL = Main lug (Thermoplastic)							
<b>Maximum Number 1" Spaces</b>							
2, 4, 6...42							
<b>Insert for 3-Phase 4-Wire Load Centers</b>							
						<b>Insert for Specials</b> G or T = Factory installed ground bar B = Bottom feed main breaker FL = Factory installed feed-through lugs D = Optional door for 6-8 circuit panel. (Doors standard on all units 12 circuits or greater) W = White Front	
						<b>Insert for PowerMark Gold</b> CU = Copper Bus 42 = Copper Bus Full 42 circuit panel	
						<b>Enclosure Type</b> C = Combination surface/flush F = Flush S = Surface R = Outdoor	
						<b>Bus Ampere Rating</b> 40 = 40 Amps      20 = 200 Amps 70 = 70 Amps      22 = 225 Amps 10 = 100 Amps     30 = 300 Amps 12 = 125 Amps     40 = 400 Amps 15 = 150 Amps     60 = 600 Amps	

#### Product Number Guide for Q-Line Plug-in Circuit Breakers

(Product number for illustrative purposes only)

<b>T</b>	<b>H</b>	<b>QL</b>	<b>1</b>	<b>1*</b>	<b>15</b>	<b>GF</b>	
<b>GE Identification</b>							
<b>Interrupting Rating</b>							
H = 10kAIC							
HH = 22kAIC							
X = 65kAIC							
<b>Type</b>							
QL = 1" plug-in							
QP = 1/2" plug-in							
QB = 1" bolt-on							
<b>Poles (1, 2, 3)</b>							
						<b>Ground Fault/Arc Fault Circuit Interrupter</b> GF = 1-pole Ground Fault Circuit Interrupter-5 mA GF1= 2-pole Ground Fault Circuit Interrupter-5 mA AF = 1- & 2-pole Arc Fault Circuit Interrupter AF2 = 1- & 2-pole Combination Arc Fault Circuit Interrupter GFEP = 1- & 2-pole Ground Fault Circuit Interrupter-30 mA GF3 = 1- & 2-pole self-test Ground Fault Circuit Interrupter - 5 mA	
						<b>Ampere Rating</b> 1 = 120/240V 2 = 240V	

\*Omit character for THQP breakers, which are all 120/240V.



# Load Centers and Circuit Breakers

## Q-Line Plug-in Circuit Breakers

# Section 1

UL Listed (Molded Case Circuit Breakers No. 489)  
 Federal Government Specification Qualified (WC-375B)  
 60°C / 75°C Conductor Rating  
 Quick Make, Quick Break  
 Box Type Terminals



THQP130



THQP230

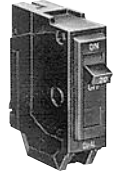

THQL1120



THQL2140

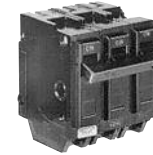

THQL32015

### Q-Line Plug-in Circuit Breakers Specifications

Breaker Type	Ampere Rating	Wire Size AWG/kcmil <sup>1</sup>	
		Cu	Al
THQP	15-25	14-8	12-8
	30-50	8-4	8-4
THQL	15-30	14-8	12-8
THHQL	35-60	8-3	8-3
TXQL	70-100	6-1/0	4-1/0
	110-125	2-2/0	2-2/0

<sup>1</sup>Solid or stranded for 14-10 AWG

### Q-Line Plug-in Circuit Breakers

120/240 Vac Ampere Rating	10,000AIC			22,000AIC		65,000AIC
	Type THQP 1/2-inch Module	Type THQL 1-inch Module		Type THHQL 1-inch Module		Type TXQL 1-inch Module
	120/240 Vac	120/240 Vac	240 Vac	120/240 Vac	240 Vac	120/240 Vac
Product Number	Product Number	Product Number	Product Number	Product Number	Product Number	Product Number
Single Pole <sup>1</sup>						
15 <sup>2</sup>	THQP115	THQL1115	-	THHQL1115	-	TXQL1115
20 <sup>2</sup>	THQP120	THQL1120	-	THHQL1120	-	TXQL1120
25	THQP125	THQL1125	-	THHQL1125	-	TXQL1125
30	THQP130	THQL1130	-	THHQL1130	-	TXQL1130
35	THQP135	THQL1135	-	THHQL1135	-	-
40	THQP140	THQL1140	-	THHQL1140	-	-
45	THQP145	THQL1145	-	THHQL1145	-	-
50	THQP150	THQL1150	-	THHQL1150	-	-
Std. Pkg.	5 cartons of 20	5 cartons of 10		5 cartons of 10		5 cartons of 10

#### Two-Pole<sup>3</sup>: Incorporates Internal Common Trip Bar

15	THQP215	THQL2115	THQL22015 <sup>4</sup>	THHQL2115	THHQL22015 <sup>4</sup>	TXQL2115
20	THQP220	THQL2120	THQL22020 <sup>4</sup>	THHQL2120	THHQL22020 <sup>4</sup>	TXQL2120
25	THQP225	THQL2125	THQL22025 <sup>4</sup>	THHQL2125	THHQL22025 <sup>4</sup>	TXQL2125
30	THQP230	THQL2130	THQL22030 <sup>4</sup>	THHQL2130	THHQL22030 <sup>4</sup>	TXQL2130
35	THQP235	THQL2135	THQL22035 <sup>4</sup>	THHQL2135	THHQL22035 <sup>4</sup>	-
40	THQP240	THQL2140	THQL22040 <sup>4</sup>	THHQL2140	THHQL22040 <sup>4</sup>	-
45	THQP245	THQL2145	THQL22045 <sup>4</sup>	THHQL2145	THHQL22045 <sup>4</sup>	-
50	THQP250	THQL2150	THQL22050 <sup>4</sup>	THHQL2150	THHQL22050 <sup>4</sup>	-
60	-	THQL2160	THQL22060 <sup>4</sup>	THHQL2160	THHQL22060 <sup>4</sup>	-
70	-	THQL2170	THQL22070 <sup>4</sup>	THHQL2170	THHQL22070 <sup>4</sup>	-
80	-	THQL2180	THQL22080 <sup>4</sup>	THHQL2180	THHQL22080 <sup>4</sup>	-
90	-	THQL2190	THQL22090 <sup>4</sup>	THHQL2190	THHQL22090 <sup>4</sup>	-
100	-	THQL21100	THQL22100 <sup>4</sup>	THHQL21100	THHQL22100 <sup>4</sup>	-
110	-	THQL21110	-	THHQL21110	-	-
125	-	THQL21125	-	THHQL21125	-	-
Std. Pkg.	5 cartons of 10	5 cartons of 5	5 cartons of 5	5 cartons of 5	5 cartons of 5	5 cartons of 5

#### Three-Pole<sup>3</sup>: Incorporates Internal Common Trip Bar

15	-	-	THQL32015	-	THHQL32015	TXQL32015
20	-	-	THQL32020	-	THHQL32020	TXQL32020
25	-	-	THQL32025	-	THHQL32025	TXQL32025
30	-	-	THQL32030	-	THHQL32030	TXQL32030
35	-	-	THQL32035	-	THHQL32035	-
40	-	-	THQL32040	-	THHQL32040	-
45	-	-	THQL32045	-	THHQL32045	-
50	-	-	THQL32050	-	THHQL32050	-
60	-	-	THQL32060	-	THHQL32060	-
70	-	-	THQL32070	-	THHQL32070	-
80	-	-	THQL32080	-	THHQL32080	-
90	-	-	THQL32090	-	THHQL32090	-
100	-	-	THQL32100	-	THHQL32100	-
Std. Pkg.			5 cartons of 3		5 cartons of 3	5 cartons of 3

<sup>1</sup>UL Listed as HACR (heating, air conditioning and refrigeration).

<sup>2</sup>UL Listed as SWD (switching duty). Suitable for 120 volts ac fluorescent lighting loads.

<sup>3</sup>15-100 amp UL Listed as HACR (heating air conditioning and refrigeration).

<sup>4</sup>Required for three-phase and High Leg Delta Systems only.

#### References:

Accessories Pages	1-24 thru 1-29
Auxiliary Switches and Shunt Trips	BuyLog pages 6-40 thru 6-42



# Load Centers and Circuit Breakers

## Special Purpose Circuit Breakers

## Section 1

60°C / 75°F Conductor Rating

Box Type Terminals

Quick-Make, Quick-Break

Multi-pole Breakers Incorporate Internal Common Trip

### Arc Fault<sup>2</sup>

UL Listed  
Arc-Fault Circuit Interrupters No. 1699

Ampere Rating	1 Pole, 120/240 Volts ac <sup>1</sup>	
	Product Number	
10,000 AIC	15	THQL1115AF2
	20	THQL1120AF2
22,000 AIC	15	THHQL1115AF2
	20	THHQL1120AF2
Std. Pkg.	10 Cartons of 1	

As of Jan. 1, 2008, 2005 NEC™ requires combination AFCI.

<sup>1</sup>Combination AFCI compliant with 2008 NEC™ and later<sup>2</sup>For 2-Pole shared neutral applications use two 1-pole circuit breakers with a handle tie. See DET-719 for more details on our Arc Fault products.

Arc Fault

### Dual Function GFCI/AFCI Ground Fault & Combination Arc Fault Circuit Breaker

UL Listed (Available December 2014)

Ampere Rating	1 Pole, 120 Volts ac	
	Product Number	
10,000 AIC	15	THQL1115DF
	20	THQL1120DF
22,000 AIC	15	THHQL1115DF
	20	THHQL1120DF
Std. Pkg.	10 Cartons of 1	



THQL1115DF

### Ground Fault

UL Listed  
Ground Fault Circuit Interrupters No. 943.  
Class A (5 milliamperes ground fault trip level).

Ampere Rating	1-Pole, 120 Volts ac		2-Pole, 120/240 Volts ac	
	Product Number		Product Number	
10,000 AIC	15	THQL1115GF	THQL2115GF1	
	20	THQL1120GF	THQL2120GF1	
	30	THQL1130GF	THQL2130GF1	
	40	-	THQL2140GF1	
	50	-	THQL2150GF1	
22,000 AIC	15	THHQL1115GF	-	
	20	THHQL1120GF	-	
	30	THHQL1130GF	-	
	Std. Pkg.	10 cartons of 1	10 cartons of 1	



THQL1120GF

### Ground Fault with Self-Test Feature

cULus  
Ground Fault Circuit Interrupters UL943 ed5 (5 milliamperes)

Ampere Rating	1-Pole, 120 Volts ac		2-Pole, 120/240 Volts ac	
	Product Number		Product Number	
10,000 AIC	15	THQL1115GFT	THQL2115GFT	
	20	THQL1120GFT	THQL2120GFT	
	25	THQL1125GFT	THQL2125GFT	
	30	THQL1130GFT	THQL2130GFT	
	40	-	THQL2140GFT <sup>3</sup>	
	50	-	THQL2150GFT <sup>3</sup>	
22,000 AIC	15	THHQL1115GFT	-	
	20	THHQL1120GFT	-	
	25	THHQL1125GFT	-	
	30	THHQL1130GFT	-	



THQL1120GFT

<sup>3</sup> UL & CSA

### PowerMark Gold Main Circuit Breakers for use with 150A-225A PowerMark Gold Load Centers (Includes mounting base)

UL Listed.

Description	Ampere Rating	Product Number	Lug Size
Main Circuit Breaker Kits 22,000 AIC	100	THQMV100D	1-300 (cu), 2/0-300
	125	THQMV125D	
	150	THQMV150D	
	175	THQMV175D	
	200	THQMV200D	
	225	THQMV225D	

**Note:** Wire bending rules affect allowed wire sizes when THQMV breakers are installed in an enclosure. For load centers, the wire range will be on the rating label. In addition, refer to the specifications for the main breaker versions of the load center you are considering to review allowed wire ranges when a TLMXX20 load center is converted to main breaker.

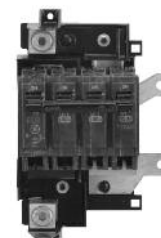

THQMVXXXD



# Load Centers and Circuit Breakers

## Special Purpose Circuit Breakers

60°C / 75°F Conductor Rating

Box Type Terminals

Quick-Make, Quick-Break

Multi-pole Breakers Incorporate Internal Common Trip

## Section 1

### PowerMark Gold Main Circuit Breaker Kit

For use with 125A PowerMark Gold load Centers; 22kAIC RMS symmetrical.

Description	Product Number
Main Circuit Breaker Kit - Order appropriate THQL 10kAIC or THHQL 22kAIC breakers separately	TQMH000 <sup>1</sup>

<sup>1</sup>Please review the footnotes listed with the individual Load Center product numbers for proper parts needed to convert to a main circuit breaker. This main breaker base is only applicable for 16 circuit and larger 125 amp load centers, 12 circuit load centers with A C24 suffix, and the TLM812RCU2.

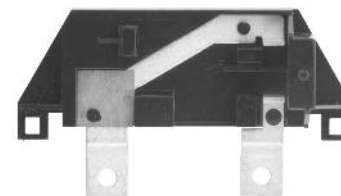

TQMH000

### Ground Fault with Equipment Protection

cULus

Ground Fault Circuit Interrupters No. 943 30 milliampere ground fault trip level

Ampere Rating	1-Pole, 120 Volts ac	2-Pole, 120/240 Volts ac
	Product Number	Product Number
10,000 AIC	15	THQL1115GFEP
	20	THQL1120GFEP
	30	THQL1130GFEP
Std. Pkg.	10 Cartons of 1	10 Cartons of 1

### Switching Neutral

UL Listed. 10kAIC RMS symmetrical.

Standard 1- or 2-pole automatic breaker plus one fully-rated, non-automatic pole.

Ampere Rating	1-Pole Plus Switching Neutral 120/240 Volts ac	2-Pole Plus Switching Neutral 120/240 Volts ac
	Product Number	Product Number
15	THQL21WY15	THQL31WY15
20	THQL21WY20	THQL31WY20
25	THQL21WY25	THQL31WY25
30	THQL21WY30	THQL31WY30
Std. Pkg.	5 cartons of 5	5 cartons of 3



THQL21WY30

### "HID" Lighting

UL Listed as HID. HID breakers have been designed to handle the current and voltage spikes that result when gaseous discharge lamps, including fluorescent and HID lamps, are switched on and off.

Ampere Rating	1-Pole, 120/240 Volts ac	2-Pole, 120/240 Volts ac
	Product Number	Product Number
10,000 AIC	15	THQL1115HID <sup>2</sup>
	20	THQL1120HID <sup>2</sup>
	30	THQL1130HID
22,000 AIC	15	THHQL1115HID <sup>2</sup>
	20	THHQL1120HID <sup>2</sup>
	30	THHQL1130HID
Std. Pkg.	5 cartons of 10	5 cartons of 5

<sup>2</sup>UL Listed as SWD (switching duty). Suitable for 120 volts ac fluorescent lighting loads.



THQL2120HID

### High Magnetic

UL Listed. 10kAIC RMS symmetrical

High short circuit setting suitable for circuits with inherent high-inrush load currents.

Ampere Rating	1-Pole, 120/240 Volts ac
	Product Number
15	THQL1115HM
20	THQL1120HM
25	THQL1125HM
30	THQL1130HM
40	THQL1140HM
50	THQL1150HM
Std. Pkg.	5 cartons of 10



THQL1140HM





# Load Centers and Circuit Breakers

## Special Purpose Circuit Breakers

# Section 1

60°C / 75°F Conductor Rating

Box Type Terminals

Quick-Make, Quick-Break

Multi-pole Breakers Incorporate Internal Common Trip

### Molded Case Switches

UL Listed

Without overload or short circuit protection.

Ampere Rating	2-Pole	3-Pole
	Product Number	Product Number
<b>120/240 Volts ac</b>		
60	TQL21Y60	-
100	TQL21Y100	-
<b>240 Volts ac</b>		
60	TQL22Y60	TQL32Y60
100	TQL22Y100	TQL32Y100
Std. Pkg.	5 cartons of 5	5 cartons of 3



TQL21Y100

### Interlocking Circuit Breakers for use in PowerMark Gold Generator Panels

Two breakers required for interlocking.

Poles	Ampere Rating	Product Number
2	30	THQL2130GEN
2	60	THQL2160GEN

### TQ Circuit Breakers

3/4" UL Classified Circuit Breakers for use in \*Square D \*\*QO Load Centers.

10 kAIC RMS symmetrical

Ampere Rating	1-Pole	2-Pole
	Product Number	Product Number
15	TQ1115	TQ2115
20	TQ1120	TQ2120
30	TQ1130	TQ2130
40	TQ1140	TQ2140
50	TQ1150	TQ2150
60	-	TQ2160
Std. Pkg.	1 carton of 10	1 carton of 5



TQ1120

### THQL 120/240 Vac, with Factory Installed Shunt<sup>1</sup>

# of Poles	Ampere Rating	Wire Range <sup>2</sup>	120/240 Vac Interrupting Rating	Product Number
1	15	(1) 14-8 Cu/12-8 Al	10kA	THQL1115ST1
1	20	(1) 14-8 Cu/12-8 Al	10kA	THQL1120ST1
1	30	(1) 14-8 Cu/12-8 Al	10kA	THQL1130ST1
1	35	(1) 8-3 Cu/8-3 Al	10kA	THQL1135ST1
1	40	(1) 8-3 Cu/8-3 Al	10kA	THQL1140ST1
1	45	(1) 8-3 Cu/8-3 Al	10kA	THQL1145ST1
1	50	(1) 8-3 Cu/8-3 Al	10kA	THQL1150ST1

<sup>1</sup>Shunt trip requires one additional pole of space.



THQL1130ST1

### THQL 120/240 Vac, Internal Common Trip with Factory Installed Shunt<sup>1</sup>

# of Poles	Ampere Rating	Wire Range <sup>2</sup>	240 Vac Interrupting Rating	Product Number
2	15	14-8 Cu/12-8 Al	10kA	THQL2115ST1
2	20	14-8 Cu/12-8 Al	10kA	THQL2120ST1
2	30	14-8 Cu/12-8 Al	10kA	THQL2130ST1
2	35	8-3 Cu/8-3 Al	10kA	THQL2135ST1
2	40	8-3 Cu/8-3 Al	10kA	THQL2140ST1
2	45	8-3 Cu/8-3 Al	10kA	THQL2145ST1
2	50	8-3 Cu/8-3 Al	10kA	THQL2150ST1
2	60	8-3 Cu/8-3 Al	10kA	THQL2160ST1
2	70	6-1/0 Cu/4-1/0 Al	10kA	THQL2170ST1
2	80	6-1/0 Cu/4-1/0 Al	10kA	THQL2180ST1
2	90	6-1/0 Cu/4-1/0 Al	10kA	THQL2190ST1
2	100	6-1/0 Cu/4-1/0 Al	10kA	THQL21100ST1
3	20	14-8 Cu/12-8 Al	10kA	THQL32020ST1
3	30	14-8 Cu/12-8 Al	10kA	THQL32030ST1
3	40	8-3 Cu/8-3 Al	10kA	THQL32040ST1
3	50	8-3 Cu/8-3 Al	10kA	THQL32050ST1
3	60	8-3 Cu/8-3 Al	10kA	THQL32060ST1
3	70	6-1/0 Cu/4-1/0 Al	10kA	THQL32070ST1
3	80	6-1/0 Cu/4-1/0 Al	10kA	THQL32080ST1
3	90	6-1/0 Cu/4-1/0 Al	10kA	THQL32090ST1
3	100	6-1/0 Cu/4-1/0 Al	10kA	THQL32100ST1

<sup>2</sup>Solid or stranded for 14-10 AWG.

\*Square D is a registered trademark of SNA Holdings, Inc. \*\*QO is a registered trademark of the Square D Company.



THQL2120ST1



THQL32020ST1





# Load Centers and Circuit Breakers

## PowerMark Gold and Plus Load Centers

### Single-Phase, Three-Wire, 120/240 Vac

Main Lugs Convertible to Main Breaker

## Section 1

Load Center  
1PH  
Main Lug  
Indoor NEMA 1

### Product Features

- UL Listed (Panelboards No. 67)
- 60°/75°C Conductor Rating
- Suitable for Use as Service Entrance Equipment when Installed in Accordance with the National Electrical Code
- 22kAIC RMS symmetrical, Except Where Noted
- 6-42 circuit devices UL Listed for bottom mounted lugs by installing complete unit (box, interior and front) upside down.
- For a listing of CSA Listed load centers, visit geindustrial.com.

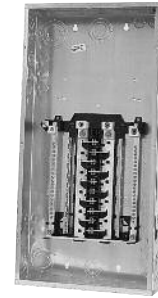

TLM2020CCU



TPL412R

### Main Lugs Factory Installed (TLM units convertible to main breaker), Indoor (NEMA 1) Enclosure

Main Ampere Rating	1 Pole, 1" Spaces	2 Pole, 1" Spaces	1 Pole, 1/2" Spaces	2 Pole, 1/2" Spaces	Total 1-pole Spaces	Front Type	Feed Type <sup>1</sup>	Box Number	Main Wire Size (AWG/kcmil) Cu-Al	Equipment Ground Kit	Product Number
40	2	1	4	1	4	Surface	Top Bottom	1A	14-4	TGK4 (order separately)	TL240SCU <sup>1,8</sup>
70	2	1	4	1	4	Surface	Top Bottom	1A	6-3	TGK4 (order separately)	TL270SCU <sup>1,8</sup>
125	4	2	8	3	8	Combination Flush/Surface	Top Bottom	2A	1-2/0	TGL1 (order separately)	TL412C <sup>1,2,8</sup>
125	4	2	8	3	8	Combination Flush/Surface	Top Bottom	2A	1-2/0	TGL1 installed	TL412CT <sup>1,2,3,8</sup>
125	4	2	8	3	8	Thermoplastic	Top Bottom	2	1-2/0	TGL1 (order separately)	TPL412C <sup>1,2,3,8</sup>
125	4	2	8	3	8	Thermoplastic	Top Bottom	2	1-2/0	TGL1 installed	TPL412CT <sup>1,2,3,8</sup>
125	6	3	12	4	12	Flush	Top Bottom	3A	6-1	TGL2 (order separately)	TLM612FCU <sup>4,8</sup>
125	6	3	12	4	12	Flush	Top Bottom	3A	6-1	TGL2 (order separately)	TLM612FCUD <sup>4,8</sup>
125	6	3	12	4	12	Flush	Top Bottom	3A	6-1	TGL2 installed	TLM612FCUDG <sup>4,8</sup>
125	6	3	12	4	12	Surface	Top Bottom	3A	6-1	TGL2 (order separately)	TLM612SCU <sup>4,8</sup>
125	6	3	12	4	12	Surface	Top Bottom	3A	6-1	TGL2 (order separately)	TLM612SCUD <sup>4,8</sup>
125	6	3	12	4	12	Surface	Top Bottom	3A	6-1	TGL2 installed	TLM612SCUDG <sup>4,8</sup>
125	8	4	16	8	16	Flush	Top Bottom	3A	6-1	TGL2 (order separately)	TLM812FCU <sup>4,8</sup>
125	8	4	16	8	16	Flush	Top Bottom	3A	6-1	TGL2 (order separately)	TLM812FCUD <sup>4,8</sup>
125	8	4	16	8	16	Flush	Top Bottom	3A	6-1	TGL2 (order separately)	TLM812FCUDG <sup>4,8</sup>
125	8	4	16	8	16	Surface	Top Bottom	3A	6-1	TGL2 (order separately)	TLM812SCU <sup>4,8</sup>
125	8	4	16	8	16	Surface	Top Bottom	3A	6-1	TGL2 (order separately)	TLM812SCUD <sup>4,8</sup>
125	8	4	16	8	16	Surface	Top Bottom	3A	6-1	TGL2 installed	TLM812SCUDG <sup>4,8</sup>
125	14	6	20	8	24	Combination Flush/Surface	Top Bottom	18	6-2/0	Included <sup>10</sup>	TLM1212CCU <sup>7,8</sup>
125	14	6	20	8	24	White Combo Flush/Surface	Top Bottom	18	6-2/0	Included <sup>10</sup>	TLM1212CCUW <sup>7,8,9</sup>

This table continued on next page



# Load Centers and Circuit Breakers

## PowerMark Gold and Plus Load Centers

### Single-Phase, Three-Wire, 120/240 Vac

Main Lugs Convertible to Main Breaker

# Section 1

Load Center  
1PH  
Main Lug  
Indoor NEMA 1

### Main Lugs Factory Installed (TLM units convertible to main breaker), Indoor (NEMA 1) Enclosure

Main Ampere Rating	1 Pole, 1"		2 Pole, 1"		Total 1-pole Spaces	Front Type	Feed Type	Box Number	Main Wire Size (AWG/kcmil) Cu-Al	Equipment Ground Kit	Product Number
	Spaces	Spaces	1 Pole, 1/2"	2 Pole, 1/2"							
125	16	8	16	6	24	Combination Flush/Surface	Top Bottom	4	6-2/0	TGK12 and TGK24 (order separately)	TLM1612CCU <sup>5</sup>
125	16	8	16	6	24	Combination Flush/Surface	Top Bottom	4	6-2/0	TGK12 and TLK20 installed	TLM1612CCUG <sup>7</sup>
125	24	12	0	0	24	Combination Flush/Surface	Top Bottom	7	6-2/0	TGK24 and TGK32 (order separately)	TLM2412CCU <sup>5</sup>
125	24	12	0	0	24	White Combo Flush/Surface	Top Bottom	7	6-2/0	TGK24 and TGK32 (order separately)	TLM2412CCUW <sup>5,9</sup>
125	24	12	0	0	24	Combination Flush/Surface	Top Bottom	7	6-2/0	TGK24 and TLK20 installed	TLM2412CCUG <sup>7</sup>
200	16	8	32	14	32	Combination Flush/Surface	Top Bottom	7	6-250	TGK32 (order separately)	TLM1620CCU <sup>6</sup>
200	16	8	32	14	32	White Combo Flush/Surface	Top Bottom	7	6-250	TGK32 (order separately)	TLM1620CCUW <sup>6,9</sup>
200	16	8	32	14	32	Combination Flush/Surface	Top Bottom	7	6-250	TGK32 installed	TLM1620CCUG <sup>6</sup>
200	20	10	40	18	40	Combination Flush/Surface	Top Bottom	8	6-250	TGK32 (order separately)	TLM2020CCU <sup>6</sup>
200	20	10	40	18	40	White Combo Flush/Surface	Top Bottom	8	6-250	TGK32 (order separately)	TLM2020CCUW <sup>6,9</sup>
200	20	10	40	18	40	Combination Flush/Surface	Top Bottom	8	6-250	TGK42 installed	TLM2020CCUG <sup>6</sup>
200	24	12	36	18	42	Combination Flush/Surface	Top Bottom	9	1-3/0 (Cu), 2/0-3/0 (Al)	TGK24 and TLK32 (order separately)	TLM2420C4 <sup>2,6</sup>
200	32	16	20	10	42	Combination Flush/Surface	Top Bottom	11	1-250 (Cu), 2/0-250 (Al)	TGK32 and TLK20 (order separately)	TLM3220C4 <sup>2,6</sup>
200	32	16	16	6	40	Combination Flush/Surface	Top Bottom	11	6-250	TGK32 (order separately)	TLM3220CCU <sup>6</sup>
200	32	16	16	6	40	White Combo Flush/Surface	Top Bottom	11	6-250	TGK32 (order separately)	TLM3220CCUW <sup>6,9</sup>
200	40	20	0	0	40	Combination Flush/Surface	Top Bottom	13	6-250	TGK42 (order separately)	TLM4020CCU <sup>6</sup>
200	40	20	0	0	40	White Combo Flush/Surface	Top Bottom	13	6-250	TGK42 (order separately)	TLM4020CCUW <sup>6,9</sup>
200	42	20	0	0	42	Combination Flush/Surface	Top Bottom	14	1-300 (Cu), 2/0-300 (Al)	TGK42 (order separately)	TLM4220CCU <sup>6</sup>
225	42	20	0	0	42	Combination Flush/Surface	Top Bottom	14	1-300 (Cu), 2/0-300 (Al)	TGK42 (order separately)	TLM4222CCU <sup>6</sup>

<sup>1</sup>No door

<sup>2</sup>10 kAIC

<sup>3</sup>125 amp maximum branch capacity.

<sup>4</sup>For main breaker, order THQLRK2 retainer kit plus 2-pole circuit breaker. See page 1-28, 100 amp max.

<sup>5</sup>For main breaker, order TQMH000. See page 1-24. Also order 2-pole THQL, THQL, or TXQL circuit breaker. See page 1-5.

<sup>6</sup>For main breaker, order THQMXXXXD circuit breaker from page 1-6.

<sup>7</sup>For main breaker applications, use reverse feed THQL breaker or THHQL circuit breaker (see page 1-5) and THQLRK3 breaker retainer (see page 1-28).

<sup>8</sup>No lock provision available. Use next size larger load center such as TLM1612CCU with a TDL106 accessory if locking provision is required.

<sup>9</sup>Minimum order QTY is 40 for below 24 circuits; QTY 24 for 24 circuits and above. (See DEE-590)

<sup>10</sup>Load center includes a factory installed ground bar and add-a-lug. See wiring diagram on page 1-30. A separate TGL2 can be added in the unlikely event that another ground bar is required.

**Note:** See page 11-4, AL Series Lighting Panelboards as replacements for 300-600A load centers.



# Load Centers and Circuit Breakers

## PowerMark Gold and Plus Load Centers

### Single-Phase, Three-Wire, 120/240 Vac

Main Lugs Convertible to Main Breaker

# Section 1

Load Center  
1PH  
Main Lug  
Outdoor NEMA 3R

### Main Lugs Factory Installed (TLM units convertible to main breaker), Outdoor (NEMA 3R) Enclosure<sup>1</sup>

Main Ampere Rating	1 Pole, 1" Spaces	2 Pole, 1" Spaces	1 Pole, 1/2" Spaces	2 Pole, 1/2" Spaces	Total 1-pole Spaces	Front Type	Feed <sup>1</sup> Type	Box Number	Main Wire Size (AWG/kcmil) Cu-Al	Equipment Ground Kit	Product Number
40	2	1	4	1	4		Top	R1A	14-4	TGK4 (order separately)	TL240RCU
70	2	1	4	1	4		Top	R1A	6-3	TGK4 (order separately)	TL270RCU
100	5	0	0	0	5	Flush	Top	R41	6-3	TGL1 installed	TL510RT <sup>2,8</sup>
125	4	2	8	3	8		Top	R1A	1-2/0	TGL1 (order separately)	TL412R1 <sup>2</sup>
125	4	2	8	3	8		Top	R1A	1-2/0	TGL1 installed	TL412RT1 <sup>2</sup>
125	4	2	8	3	8		Top	R41	1-2/0	TGL1 (order separately)	TL412R2 <sup>2</sup>
125	4	2	8	3	8	Thermoplastic Front	Top	R1	1-2/0	TGL1 (order separately)	TPL412R <sup>2,3</sup>
125	4	2	8	3	8	Thermoplastic Front	Top	R1	1-2/0	TGL1 installed	TPL412RT <sup>2,3</sup>
125	4	3	12	4	12		Top	R2A	6-1	TGK12 (order separately)	TLM612RCU <sup>4</sup>
125	8	4	16	8	16		Top	R2A	6-1	TGK12 (order separately)	TLM812RCU <sup>4</sup>
125	8	4	16	8	16		Top	R3A	6-1	TGK12 (order separately)	TLM812RCU <sup>25</sup>
125	14	6	20	8	24		Top	R3A	6-2/0	TGK12 (order separately) TGK24 (order separately)	TLM1212RCU <sup>7,9</sup>
125	24	12	0	0	24		Top Bottom	R4A	6-2/0	TGK24 (order separately) TGK32 (order separately)	TLM2412RCU <sup>5</sup>
150	24	12	12	4	30		Top Bottom	R6A	1-3/0 (Cu), 2/0-3/0 (Al)	TGK24 (order separately) TGK32 (order separately)	TLM2415RCU <sup>6</sup>
200	12	6	24	10	24		Top	R5A	6-250	TGK24 (order separately)	TLM1220RCU <sup>6</sup>
200	16	8	32	14	32		Top	R5A	6-250	TGK32 (order separately)	TLM1620RCU <sup>6</sup>
200	20	10	40	18	40		Top	R6A	6-250	TGK24 (order separately) TGK42 (order separately)	TLM2020RCU <sup>6</sup>
200	24	12	36	18	42		Top Bottom	R39	1-250 (Cu), 2/0-250 (Al)	TGK24 (order separately)	TLM2420R42
200	32	16	16	6	40		Top Bottom	R7A	1-250 (Cu), 2/0-250 (Al)	TGK32 (order separately)	TLM3220RCU <sup>6</sup>
200	40	20	0	0	40		Top Bottom	R8A	6-250	TGK42 (order separately)	TLM4020RCU <sup>6</sup>
225	42	20	0	0	42		Top Bottom	R8A	1-300 (Cu), 2/0-300 (Al)	TGK42 (order separately)	TLM4222RCU <sup>6</sup>

<sup>1</sup>40-225 amp single-phase devices have removable closing caps. Larger ampere devices require field-cut openings. Order hubs separately. See page 1-27.  
<sup>2</sup>10 kAIC.

<sup>3</sup>125 amp maximum branch capacity.

<sup>4</sup>For main breaker, order THQLRK2 retainer kit plus 2-pole circuit breaker. See page 1-28, 100 amp maximum due to wire bending requirements.

<sup>5</sup>For main breaker, order TQMH000. See page 1-24. Also order 2-pole THQL or THHQL circuit breaker. See page 1-5.

<sup>6</sup>For main breaker, order THQMXXDX circuit breaker from page 1-6.

<sup>7</sup>For main breaker applications, use reverse feed THQL or THHQL circuit breaker (see page 1-5) and THQLRK3 breaker retainer (see page 1-28).

<sup>8</sup>Main and branch breakers are limited to 70 amps.

<sup>9</sup>Load center includes a factory installed ground bar and add-a-lug. See wiring diagram on page 1-30. A separate TGL2 can be added in the unlikely event that another ground bar is required.

**Note:** See page 11-4, AL Series Lighting Panelboards as replacements for 300-600A load centers.



# Load Centers and Circuit Breakers

## PowerMark Gold and Plus Main Breaker Load Centers

### Single-Phase, Three-Wire, 120/240 Vac

Main Breaker Factory Installed

## Section 1

Load Center  
1PH  
Main Breaker  
Indoor NEMA 1

### Product Features

- UL Listed (Panelboards No. 67)
- 60°C/75°C Conductor Rating
- Suitable for Use as Service Entrance Equipment when Installed in Accordance with the National Electrical Code
- 22kAIC RMS symmetrical, Except Where Noted
- 6-42 circuit devices UL Listed for bottom mounted lugs by installing complete unit (box, interior and front) upside down.
- For a listing of CSA Listed load centers, visit [geindustrial.com](http://geindustrial.com).



TM2020CCU

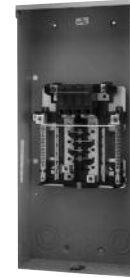

TM820RCUFL

### Indoor (NEMA 1) Enclosure

Main Ampere Rating	1 Pole, 1" Spaces	2 Pole, 1" Spaces	1 Pole, 1/2" Spaces	2 Pole, 1/2" Spaces	Total 1-pole Spaces	Front Type	Feed Type	Box Number	Main Wire Size (AWG/kcmil) Cu-Al	Equipment Ground Kit	Product Number
100	12	5	20	8	22	Combination Flush/Surface Front	Top Bottom	18	4-1/0	Included <sup>1</sup>	TM1210CCU <sup>2</sup>
100	24	12	0	0	24	Combination Flush/Surface Front	Top Bottom	7	1-2/0	TGK24, TGK32 and TLK20 (order separately)	TM2410CCU
100	20	10	0	0	20	Combination Flush/Surface Front	Top Bottom	6	4-1/0	TGK24 (order separately)	TM2010CCU
100	32	16	0	0	32	Combination Flush/Surface Front	Top Bottom	11	4-1/0	TGK32 (order separately)	TM3210CCU
125	12	5	20	8	22	Combination Flush/Surface Front	Top Bottom	18	1-2/0	Included <sup>1</sup>	TM1212CCU <sup>2</sup>
125	24	12	0	0	24	Combination Flush/Surface Front	Top Bottom	7	1-2/0	TGK24 (order separately)	TM2412CCU
125	16	8	16	6	24	Combination Flush/Surface Front	Top Bottom	4	1-2/0	TGK12 (order separately) TGK24 (order separately)	TM1612CCU
125	16	8	16	6	24	Combination Flush/Surface Front	Top Bottom	4	1-2/0	TGK24 installed	TM1612CCUG
150	16	8	32	14	32	Combination Flush/Surface Front	Top Bottom	7	1-3/0 (Cu), 2/0-3/0 (Al)	TGK24 (order separately) TGK32 (order separately)	TM1615CCU
150	16	8	32	14	32	Combination Flush/Surface Front	Top Bottom	7	1-3/0 (Cu), 2/0-3/0 (Al)	TGK32 installed	TM1615CCUG

This table continued on next page



# Load Centers and Circuit Breakers

## PowerMark Gold and Plus Main Breaker Load Centers

### Single-Phase, Three-Wire, 120/240 Vac

Main Breaker Factory Installed

## Section 1

Load Center  
1PH  
Main Breaker  
Indoor NEMA 1

### Indoor (NEMA 1) Enclosure

Main Ampere Rating	1 Pole, 1" Spaces	2 Pole, 1" Spaces	1 Pole, 1/2" Spaces	2 Pole, 1/2" Spaces	Total 1-pole Spaces	Front Type	Feed Type	Box Number	Main Wire Size (AWG/kcmil) Cu-Al	Equipment Ground Kit	Product Number
150	32	16	0	0	32	Combination Flush/Surface	Top Bottom	11	1-3/0 (Cu), 2/0-3/0 (Al)	TGK32 (order separately)	TM3215CCU
150	24	12	36	18	42	Combination Flush/Surface	Top Bottom	9	1-3/0 (Cu), 2/0-3/0 (Al)	TGK24 (order separately), TLK32 (order separately)	TM2415C42
150	32	16	20	10	42	Combination Flush/Surface	Top Bottom	11	1-3/0 (Cu), 2/0-3/0 (Al)	TGK32 and TLK20 (order separately)	TM3215C42
200	14	8	32	14	32	Combination Flush/Surface	Top Bottom	7	1-250 (Cu), 2/0-250 (Al)	TGK32 (order separately)	TM1620CCU
200	14	8	32	14	32	Combination Flush/Surface	Top Bottom	8	1-250 (Cu), 2/0-250 (Al)	TGK32 installed	TM1620CCUG
200	18	10	40	18	40	Combination Flush/Surface	Top Bottom	8	1-250 (Cu), 2/0-250 (Al)	TGK32 (order separately)	TM2020CCU
200	18	10	40	18	40	White Combo Flush/Surface	Top Bottom	8	1-250 (Cu), 2/0-250 (Al)	TGK24 (order separately), TGK42 (order separately)	TM2020CCUW <sup>3</sup>
200	18	10	40	18	40	Combination Flush/Surface	Top Bottom	8	1-250 (Cu), 2/0-250 (Al)	TGK32 (order separately)	TM2020CCUG
200	18	10	40	18	40	White Combo Flush/Surface	Top Bottom	8	1-250 (Cu), 2/0-250 (Al)	TGK32 (order separately)	TM2020CCUGW <sup>3</sup>
200	32	16	16	6	40	Combination Flush/Surface	Top Bottom	11	1-250 (Cu), 2/0-250 (Al)	TGK32 (order separately)	TM3220CCU
200	40	20	0	0	40	Combination Flush/Surface	Top Bottom	13	1-250 (Cu), 2/0-250 (Al)	TGK42 (order separately)	TM4020CCU
200	32	16	20	10	42	Combination Flush/Surface	Top Bottom	11	1-250 (Cu), 2/0-250 (Al)	TGK32 and TLK20 (order separately)	TM3220C42
200	42	20	0	0	42	Combination Flush/Surface	Top Bottom	14	1-300 (Cu), 2/0-300 (Al)	TGK42 (order separately)	TM4220CCU
225	42	20	0	0	42	Combination Flush/Surface	Top Bottom	14	1-300 (Cu), 2/0-300 (Al)	TGK42 (order separately)	TM4222CCU

<sup>1</sup>Load center includes a factory installed ground bar and add-a-lug. See wiring diagram on page 1-30. A separate TGL2 can be added in the unlikely event that another ground bar is required.

<sup>2</sup>No lock provision available. Use next size larger load center such as TLM1612CCU with a TDL106 accessory if locking provision is required.

<sup>3</sup>Minimum order QTY is 40 for below 24 circuits; QTY 24 for 24 circuits and above. (See DEE-590)

Load Center  
1PH  
Main Breaker  
Outdoor NEMA 3R

### Outdoor (NEMA 3R) Enclosure<sup>4</sup>

Main Ampere Rating	1 Pole, 1" Spaces	2 Pole, 1" Spaces	1 Pole, 1/2" Spaces	2 Pole, 1/2" Spaces	Total 1-pole Spaces	Feed Type	Box Number	Main Wire Size (AWG/kcmil) Cu-Al	Equipment Ground Kit	Product Number
100	12	5	20	8	22	Top	R3A	4-1/0	TGK12 (order separately), TGK24 (order separately)	TM1210RCU
100	20	10	0	0	30	Top	R4	4-1/0	TGK24 (order separately)	TM2010RCU
125	12	5	20	8	22	Top	R3A	1-2/0	TGK12 (order separately), TGK24 (order separately)	TM1212RCU
125	24	12	0	0	24	Top	R4	1-2/0	TGK24 (order separately)	TM2412RCU
150	8	4	16	6	16	Top	R5	1-250 (Cu), 2/0-250 (Al)	TGK24 (order separately)	TM815RCUFL
150	16	8	32	14	32	Top	R5	1-3/0 (Cu), 2/0-3/0 (Al)	TGK24 (order separately), TGK32 (order separately)	TM1615RCU
150	24	12	12	4	30	Top	R6	1-3/0 (Cu), 2/0-3/0 (Al)	TGK24 (order separately), TGK32 (order separately)	TM2415RCU
150	24	12	36	18	42	Top Bottom	R39	1-250 (Cu), 2/0-250 (Al)	TGK24 (order separately)	TM2415R42
150	32	16	0	0	32	Top	R7	1-3/0 (Cu), 2/0-3/0 (Al)	TGK32 (order separately)	TM3215RCU
200	8	4	16	6	16	Top	R5	1-250 (Cu), 2/0-250 (Al)	TGK32 (order separately)	TM820RCUFL
200	20	10	40	18	40	Top	R6	1-250 (Cu), 2/0-250 (Al)	TGK24 (order separately), TGK42 (order separately)	TM2020RCU
200	24	12	36	18	42	Top Bottom	R39	1-250 (Cu), 2/0-250 (Al)	TGK24 (order separately)	TM2420R42
200	32	16	16	6	40	Top	R7	1-250 (Cu), 2/0-250 (Al)	TGK32 (order separately)	TM3220RCU
200	40	20	0	0	40	Top	R8	1-250 (Cu), 2/0-250 (Al)	TGK42 (order separately)	TM4020RCU
225	8	4	16	6	16	Top	R5	1-250 (Cu), 2/0-250 (Al)	TGK24 (order separately)	TM822RCUFL
225	42	20	0	0	42	Top	R8	1-300 (Cu), 2/0-300 (Al)	TGK42 (order separately)	TM4222RCU

<sup>4</sup>100-225 amp devices have removable closing caps. Larger ampere devices require field-cut openings. Order hubs separately. See page 1-27.

**Note:** See page 11-4, AL Series Lighting Panelboards as replacements for 300-600A load centers.



# Load Centers and Circuit Breakers

## PowerMark Plus™ Load Centers

### Three-Phase, Four-Wire, 208Y/120 Vac<sup>2</sup>

Main Lugs Factory Installed

# Section 1

Load Center  
3PH  
Main Lugs  
Indoor NEMA 1

#### Product Features

- UL Listed (Panelboards No. 67)
- 60°/75°C Conductor Rating
- Suitable for Use as Service Entrance Equipment when Installed in Accordance with the National Electrical Code
- 22kAIC RMS symmetrical Short-circuit Rating Standard
- Bottom feed models available where noted with a “B” suffix.
- For a listing of CSA Listed load centers, visit [geindustrial.com](http://geindustrial.com).
- Copper breaker mounting stabs with aluminum bus<sup>1</sup>

#### Indoor (NEMA 1) Enclosure

Main Ampere Rating	1 Pole, 1" Spaces	2 Pole, 1" Spaces	3 Pole, 1" Spaces	Total 1-pole Spaces	Front Type	Feed Type	Box Number	Main Wire Size (AWG/kcmil) Cu-Al	Equipment Ground Kit	Product Number
125	12	6	4	12	Combination Flush/Surface Front	Top Bottom	4	6-2/0	TGK12 (order separately) TGK24 (order separately)	TL12412C <sup>3</sup>
150	18	8	6	18	Combination Flush/Surface Front	Top Bottom	7	1-3/0 (Cu), 2/0-3/0 (Al)	TGK24 (order separately) TGK32 (order separately)	TL18415C <sup>3</sup>
150	24	12	8	24	Combination Flush/Surface Front	Top Bottom	7	1-3/0 (Cu), 2/0-3/0 (Al)	TGK24 (order separately) TGK32 (order separately)	TL24415C <sup>3</sup>
200	18	8	6	18	Combination Flush/Surface Front	Top Bottom	8	1-250 (Cu), 2/0-250 (Al)	TGK32 (order separately)	TL18420C <sup>3</sup>
200	30	14	10	30	Combination Flush/Surface Front	Top Bottom	11	1-250 (Cu), 2/0-250 (Al)	TGK32 (order separately)	TL30420C <sup>3</sup>
200	42	20	14	42	Combination Flush/Surface Front	Top Bottom	13	1-250 (Cu), 2/0-250 (Al)	TGK42 (order separately)	TL42420C
225	30	14	10	30	Combination Flush/Surface Front	Top Bottom	15	1-300 (Cu), 2/0-300 (Al)	(2) TGL2 (order separately)	TL30422C <sup>4</sup>
225	42	20	14	42	Combination Flush/Surface Front	Top Bottom	15	1-300 (Cu), 2/0-300 (Al)	(2) TGL2 (order separately)	TL42422C <sup>4</sup>

<sup>1</sup>Three-phase PowerMark Plus load centers have aluminum bus with copper breaker mounting stabs, providing copper-to-copper contact at breaker stabs.

<sup>2</sup>Also UL Listed for three-phase, four-wire 240/120 Volts ac delta and three-phase, three-wire 240 Volts ac branch breakers installed.

<sup>3</sup>Alternate main breaker: 100 Amp max. THQL three-pole, use retainer THQLRK. See page 1-28.

<sup>4</sup>Not suitable for use as service entrance equipment.

**Note:** See page 11-4, AL Series Lighting Panelboards as replacements for 300-600A load centers.



# Load Centers and Circuit Breakers

## PowerMark Plus™ Load Centers

### Three-Phase, Four-Wire, 208Y/120Vac<sup>1</sup>

Main Circuit Breaker or Main Lugs Factory Installed



TM24420CB

## Section 1

Load Center  
3PH  
Main Lugs  
Outdoor NEMA 3R

### Main Lugs Factory Installed Outdoor (NEMA 3R) Enclosure

Main Ampere Rating	1 Pole, 1" Spaces	2 Pole, 1" Spaces	3 Pole, 1" Spaces	Total 1-pole Spaces	Feed Type	Box Number	Main Wire Size (AWG/kcmil) Cu-Al	Equipment Ground Kit	Product Number
125	12	6	4	12	Top	R3	6-2/0	TGK12 (order separately) TGK24 (order separately)	TL12412R <sup>2,4</sup>
150	18	8	6	18	Top	R4	1-3/0 (Cu), 2/0-3/0 (Al)	TGK24 (order separately) TGK32 (order separately)	TL18415R <sup>2,4</sup>
150	24	12	8	24	Top	R4	1-3/0 (Cu), 2/0-3/0 (Al)	TGK24 (order separately) TGK32 (order separately)	TL24415R <sup>2,4</sup>
200	18	8	6	18	Top	R4	1-250 (Cu), 2/0-250 (Al)	TGK32 (order separately)	TL18420R <sup>2,4</sup>
200	30	14	10	30	Top	R6	1-250 (Cu), 2/0-250 (Al)	TGK32 (order separately)	TL30420R <sup>2,4</sup>
200	42	20	14	42	Top	R8	1-250 (Cu), 2/0-250 (Al)	TGK42 (order separately)	TL42420R <sup>2,3</sup>
225	42	20	14	42	Top	R8	1-300 (Cu), 2/0-300 (Al)	TGK42 (order separately)	TL42422R <sup>2,3</sup>

<sup>1</sup>Also UL Listed for three-phase, four-wire 240/120 Volts ac delta and three-phase, three-wire 240 Volts ac branch breakers installed.

<sup>2</sup>100-200 Amp three-phase devices have removable closing cap. Larger Ampere devices require field cut openings. Order hubs separately. See page 1-27.

<sup>3</sup>Not suitable for use as service entrance equipment.

<sup>4</sup>Alternate main breaker: 100 Amp max. THQL three-pole, use retainer THQLRK. See page 1-28.

### Load Center 3PH Main Breaker Indoor NEMA 1

### Main Breaker Factory Installed Indoor (NEMA 1) Enclosure

Main Ampere Rating	1 Pole, 1" Spaces	2 Pole, 1" Spaces	3 Pole, 1" Spaces	Total 1-pole Spaces	Front Type	Feed <sup>2</sup> Type	Box Number	Main Wire Size (AWG/kcmil) Cu-Al	Equipment Ground Kit	Product Number
100	12	6	4	12	Combination Flush/Surface Front	Top Bottom	6	6-1/0 (Cu), 4-1/0 (Al)	TGK12 (order separately) TGK24 (order separately)	TM12410C <sup>6</sup>
100	18	8	6	18	Combination Flush/Surface Front	Top Bottom	6	6-1/0 (Cu), 4-1/0 (Al)	TGK24 (order separately) TGK32 (order separately)	TM18410C <sup>6</sup>
125	30	14	10	30	Combination Flush/Surface Front	Top	11	1-3/0 (Cu), 2/0-3/0 (Al)	TGK32 (order separately)	TM30412C
125	30	14	10	30	Combination Flush/Surface Front	Bottom	11	1-3/0 (Cu), 2/0-3/0 (Al)	TGK32 (order separately)	TM30412CB
150	24	12	8	24	Combination Flush/Surface Front	Top	11	1-3/0 (Cu), 2/0-3/0 (Al)	TGL1, TGL2, TGL20, TNG3, TGN6 (order separately)	TM24415C
150	24	12	8	24	Combination Flush/Surface Front	Bottom	11	1-3/0 (Cu), 2/0-3/0 (Al)	TGK32 (order separately)	TM24415CB
150	30	14	10	30	Combination Flush/Surface Front	Top	11	1-3/0 (Cu), 2/0-3/0 (Al)	TGK32 (order separately)	TM30415C
150	30	14	10	30	Combination Flush/Surface Front	Bottom	11	1-3/0 (Cu), 2/0-3/0 (Al)	TGK32 (order separately)	TM30415CB
150	42	20	14	42	Combination Flush/Surface Front	Top	13	1-3/0 (Cu), 2/0-3/0 (Al)	TGK42 (order separately)	TM42415C
150	42	20	14	42	Combination Flush/Surface Front	Bottom	13	1-3/0 (Cu), 2/0-3/0 (Al)	TGK42 (order separately)	TM42415CB
200	24	12	8	24	Combination Flush/Surface Front	Top	11	1-300 (Cu), 2/0-300 (Al)	TGK32 (order separately)	TM24420C
200	24	12	8	24	Combination Flush/Surface Front	Bottom	11	1-300 (Cu), 2/0-300 (Al)	TGK32 (order separately)	TM24420CB

<sup>5</sup>Also UL Listed for three-phase, four-wire 240/120 Volts ac delta and three-phase, three-wire 240 Volts ac branch breakers installed.

<sup>6</sup>100 Amp indoor devices UL listed for bottom-feed by installing complete unit upside-down.

**Note:** See page 11-4, AL Series Lighting Panelboards as replacements for 300-600A load centers.

This table continued on next page





# Load Centers and Circuit Breakers

## PowerMark Plus™ Load Centers

### Three-Phase, Four-Wire, 208Y/120 Vac<sup>1</sup>

Main Circuit Breaker Factory Installed

# Section 1

Load Center  
3PH  
Main Breaker  
Indoor NEMA 1

#### Indoor (NEMA 1) Enclosure

Main Ampere Rating	1 Pole, 1" Spaces	2 Pole, 1" Spaces	3 Pole, 1" Spaces	Total 1-pole Spaces	Front Type	Feed <sup>2</sup> Type	Box Number	Main Wire Size (AWG/kcmil) Cu-Al	Equipment Ground Kit	Product Number
200	30	14	10	30	Combination Flush/Surface Front	Top	12	1-250 (Cu), 2/0-250 (Al)	TGK32 (order separately)	TM30420C
200	30	14	10	30	Combination Flush/Surface Front	Bottom	12	1-250 (Cu), 2/0-250 (Al)	TGK32 (order separately)	TM30420CB
200	42	20	14	42	Combination Flush/Surface Front	Top	14	1-250 (Cu), 2/0-250 (Al)	TGK42 (order separately)	TM42420C
200	42	20	14	42	Combination Flush/Surface Front	Bottom	14	1-250 (Cu), 2/0-250 (Al)	TGK42 (order separately)	TM42420CB
225	42	20	14	42	Combination Flush/Surface Front	Top	15	1-300 (Cu), 2/0-300 (Al)	(2) TGL2 (order separately)	TM42422C
225	42	20	14	42	Combination Flush/Surface Front	Bottom	15	1-300 (Cu), 2/0-300 (Al)	(2) TGL2 (order separately)	TM42422CB

<sup>1</sup>Also UL Listed for three-phase, four-wire 240/120 Volts ac delta and three-phase, three-wire 240 Volts ac branch breakers installed.

#### Load Center 3PH Main Breaker Outdoor NEMA 3R

#### Outdoor (NEMA 3R) Enclosure

Main Ampere Rating	1 Pole, 1" Spaces	2 Pole, 1" Spaces	3 Pole, 1" Spaces	Total 1-pole Spaces	Feed <sup>2</sup> Type	Box Number	Main Wire Size (AWG/kcmil) Cu-Al	Equipment Ground Kit	Product Number
100	18	8	6	18	Top	R4	6-1/0 (Cu), 4-1/0 (Al)	TGK24 (order separately) TGK32 (order separately)	TM18410R <sup>2</sup>
125	30	14	10	30	Top	R7	1-3/0 (Cu), 2/0-3/0 (Al)	TGK32 (order separately)	TM30412R <sup>2</sup>
150	24	12	8	24	Top	R6	1-3/0 (Cu), 2/0-3/0 (Al)	TGK32 (order separately)	TM24415R <sup>2</sup>
150	30	14	10	30	Top	R7	1-3/0 (Cu), 2/0-3/0 (Al)	TGK32 (order separately)	TM30415R <sup>2</sup>
200	30	14	10	30	Top	R7	1-250 (Cu), 2/0-250 (Al)	TGK32 (order separately)	TM30420R <sup>2</sup>
200	42	20	14	42	Top	R8	1-250 (Cu), 2/0-250 (Al)	TGK42 (order separately)	TM42420R <sup>2</sup>
225	42	20	14	42	Top	R8	1-300 (Cu), 2/0-300 (Al)	TGK42 (order separately)	TM42422R <sup>2</sup>

<sup>2</sup>100-200 Amp three-phase devices have removable closing cap. Larger Ampere devices require field cut openings. Order hubs separately. See page 1-27.

**Note:** See page 11-4, AL Series Lighting Panelboards as replacements for 300-600A load centers.



# Load Centers and Circuit Breakers

## PowerMark Gold Load Centers

### Single-Phase, Three-Wire, 120/240 Vac

# Section 1

Load Center  
Generator Panels  
Riser Panels  
Spa Panels

#### Product Features - Generator Panels

- Suitable for use in accordance with Article 702 of the National Electrical Code, ANSI/NFPA 70
- Single-phase, 2 interlock 60A or 30A main breakers, 8 circuits max.
- Safety and convenience when using a generator - 14,000 peak wattage, 11,520 continuous load, 48 amps at 240 volts.
- Maintains power to such critical circuits as those for furnace, pump, refrigerator, lights.
- Connected dual breaker mechanism ensures that only one source is active at a time.



TL412R250GF



TM830FCUGEN

#### Generator Panels, Two Interlocked Main Breakers Factory Installed Indoor (NEMA 1) Enclosure

Main Ampere Rating	1 Pole, 1" Spaces	2 Pole, 1" Spaces	1 Pole, 1/2" Spaces	2 Pole, 1/2" Spaces	Total 1-pole Spaces	Front Type	Feed Type	Box Number	Main Wire Size (AWG/kcmil) Cu-Al	Equipment Ground Kit	Product Number
30	4	2	8	4	8	Flush Front	Top Bottom	3A	6-1	TGK12 included	TM830FCUGEN
30	4	2	8	4	8	Surface Front	Top Bottom	3A	6-1	TGK12 included	TM830SCUGEN
60	4	2	8	4	8	Flush Front	Top Bottom	3A	6-1	TGK12 included	TM860FCUGEN
60	4	2	8	4	8	Surface Front	Top Bottom	3A	6-1	TGK12 included	TM860SCUGEN

#### Generator Panels, Two Interlocked Main Breakers Factory Installed Outdoor (NEMA 3R) Enclosure

Main Ampere Rating	1 Pole, 1" Spaces	2 Pole, 1" Spaces	1 Pole, 1/2" Spaces	2 Pole, 1/2" Spaces	Total 1-pole Spaces	Feed Type	Box Number	Main Wire Size (AWG/kcmil) Cu-Al	Equipment Ground Kit	Product Number
30	4	2	8	4	8	Top	R2A	6-1	TGK12 included	TM830RCUGEN
60	4	2	8	4	8	Top	R2A	6-1	TGK12 included	TM860RCUGEN

#### Riser Panels

##### Indoor (NEMA 1) Enclosure

Main Ampere Rating	1 Pole, 1" Spaces	2 Pole, 1" Spaces	1 Pole, 1/2" Spaces	2 Pole, 1/2" Spaces	Total 1-pole Spaces	Front Type	Feed Type	Box Number	Main Wire Size (AWG/kcmil) Cu-Al	Equipment Ground Kit	Product Number
125	20	10	40	20	40	Combination Flush/Surface Front	Top	9A	6-2/0	TGK12 (order separately)	TLM2012CCURP

Tap kits required, order separately. See page 1-29.  
Auxiliary gutters available. See page 1-29.

#### Spa Panels

##### Outdoor (NEMA 3R) Enclosure

Main Ampere Rating	1 Pole, 1" Spaces	2 Pole, 1" Spaces	1 Pole, 1/2" Spaces	2 Pole, 1/2" Spaces	Total 1-pole Spaces	Load Center Type	Feed Type	Box Number	Main Wire Size (AWG/kcmil) Cu-Al	Equipment Ground Kit	Product Number
125	4	2	8	4	8	Factory Included 50A GFCI	Top Bottom		1-2/0	TGL1 installed	TL412R250GF
125	4	2	8	4	8	Factory Included 60A GFCI	Top Bottom		1-2/0	TGL1 installed	TL412R260GF

#### Twist Lock Power Inlets

Receptacles	Amps	Volts	UL	Product Number
L14-20	20	120/240	Canada, US	T020N
L14-30	30	120/240	Canada, US	T030N
CS637	50	120/240	Canada, US	T050N



# Load Centers and Circuit Breakers

## PowerMark Gold Meter Socket Load Centers

### Single-Phase, Three-Wire, 120/240 Vac

With Bonded Neutrals

## Section 1

Meter Socket LC  
1PH  
Ring Type  
Meter Main  
NEMA 3R



TSM2020CFCU

Designed and manufactured for quality applications, these PowerMark Gold Meter Socket Load Centers are a superior solution to specific applications. Increased durability and reliability, maximum circuit layout flexibility and ease of installation add up to lower total installed cost.

The Ringless UL Style meter socket load centers (Florida Meter Group, Georgia Power, Others) are specifically designed to meet UL requirements as well as some special features required by specific utilities. If your local utility does not require specific approval and you need a ringless meter socket load center, use the Florida Meter Group style.

Main Ampere Rating	1 Pole, 1" Spaces	2 Pole, 1" Spaces	1 Pole, 1/2" Spaces	2 Pole, 1/2" Spaces	Total 1-pole Spaces	Enclosure Type	Front Type	Bypass Type	UL Incoming	Agency Certification	Product Number
<b>Meter Main - Ring Type, Field Installed Mains</b>											
100	2	1	4	1	4	Outdoor (NEMA 3R)	Semi-Flush	None	OH/UG	UL EUSERC	TSL210CFCU <sup>1</sup>
100	2	1	4	1	4	Outdoor (NEMA 3R)	Surface <sup>2</sup>	None	OH/UG	UL EUSERC	TSL210CSCU <sup>1,2,3</sup>
125	4	2	6	3	6	Outdoor (NEMA 3R)	Surface <sup>2</sup>	None	OH/UG	UL EUSERC	TSL412CSCU <sup>1,2,3</sup>
200	4	2	6	3	6	Outdoor (NEMA 3R)	Semi-Flush	None	OH/UG	UL EUSERC	TSL420CFCU <sup>1,4,5</sup>
200	4	2	6	3	6	Outdoor (NEMA 3R)	Surface <sup>2</sup>	None	OH/UG	UL EUSERC	TSL420CSCU <sup>1,2,3,4</sup>
<b>Meter Main - Factory Installed Mains</b>											
100	0	0	0	0	0	Outdoor (NEMA 3R)	Surface <sup>2</sup>	None	OH/UG	UL	TM10RMC <sup>2</sup>
125	0	0	0	0	0	Outdoor (NEMA 3R)	Surface <sup>2</sup>	None	OH/UG	UL	TM12RMC <sup>2</sup>
150	0	0	0	0	0	Outdoor (NEMA 3R)	Surface <sup>2</sup>	None	OH/UG	UL	TM15RMC <sup>2</sup>
200	0	0	0	0	0	Outdoor (NEMA 3R)	Surface <sup>2</sup>	None	OH/UG	UL	TM20RMC <sup>2</sup>

<sup>1</sup>Accepts field installed fifth jaw terminal in the 3 or 9 o'clock position. Product number TJAW53; order separately.

<sup>2</sup>Devices include removable closing cap. Order hub separately. See page 1-27.

<sup>3</sup>Surface mounted units have two hub provisions on top end wall.

<sup>4</sup>THQL and THHQL only, 125 amp max. TQDL is obsolete.

<sup>5</sup>Restricted

### Application Data

Product Number	Box Number	Unit Width (in inches)	Unit Height (in inches)	Depth (in inches)	Factory Inst. Svcs Disc	Field Inst. Svcs Disc	Main Wire Size (AWG/kcmil) Cu-Al	Equipment Ground Kit
TSL210CFCU	R12	14	23-1/2	4-7/8		THQP/THQL	6-2/0	TGL1 installed
TSL210CSCU	R12	14	23-1/2	4-7/8		THQP/THQL	6-2/0	TGL1 installed
TSL412CSCU	R12	14	23-1/2	4-7/8		THQP/THQL	6-2/0	TGL1 installed
TSL420CFCU	R14	14	30-3/4	5-3/4		THQP/THQL	1-250	TGL1 installed
TSL420CSCU	R14	14	30-3/4	5-3/4		THQP/THQL	1-250	TGL1 installed
TM10RMC	R32	16	17	5	TQD	Field Installed <sup>4</sup>	2-250	
TM12RMC	R32	16	17	5	TQD	Field Installed <sup>4</sup>	2-250	
TM15RMC	R32	16	17	5	TQD	Field Installed <sup>4</sup>	2-250	
TM20RMC	R32	16	17	5	TQD	Field Installed <sup>4</sup>	2-250	



# Load Centers and Circuit Breakers

## PowerMark Gold Meter Socket Load Centers

### Single-Phase, Three-Wire, 120/240 Vac

With Bonded Neutrals

# Section 1

Meter Socket LC  
1PH  
Ring Type  
Farm Panel  
Main Breaker  
NEMA 3R

#### Ring Type - Farm Panel - Main Breaker

Main Ampere Rating	1 Pole, 1" Spaces	2 Pole, 1" Spaces	1 Pole, 1/2" Spaces	2 Pole, 1/2" Spaces	Total 1-pole Spaces	Enclosure Type	Front Front Type	Bypass Type	UL Incoming	Agency Certification	Product Number
200	4	2	8	3	8	Outdoor (NEMA 3R)	Surface	None	OH/UG	UL EUSERC	TSF420CSCU <sup>1,2</sup>

<sup>1</sup>Devices include removable closing cap. Order hub separately. See page 1-27.

<sup>2</sup>Separate field mounted service disconnect can be added, THQL/THHQL. See wiring diagram on page 1-35.

#### Application Data

Product Number	Box Number	Unit Width (in inches)	Unit Height (in inches)	Depth (in inches)	Factory Inst. Svcs Disc	Field Inst. Svcs Disc	Main Wire Size (AWG/kcmil) Cu-Al	Equipment Ground Kit
TSF420CSCU	R16	16-3/4	33	6-3/16	THQMV	THQL/THHQL	1-300	TGK12 (order separately)

#### Ring Type Feed-Thru - Main Breaker

Main Ampere Rating	1 Pole, 1" Spaces	2 Pole, 1" Spaces	1 Pole, 1/2" Spaces	2 Pole, 1/2" Spaces	Total 1-pole Spaces	Enclosure Type	Front Type	Bypass Type	UL Incoming	Agency Certification	Product Number
150	4	2	8	3	8	Outdoor (NEMA 3R)	Surface	None	OH/UG	UL	TSM415CSCU <sup>1</sup>
150	8	4	16	6	16	Outdoor (NEMA 3R)	Surface	None	OH/UG	UL	TSM815CSCU <sup>1</sup>
150	8	4	16	6	16	Outdoor (NEMA 3R)	Surface	None	OH/UG	UL	TSM815CSFL <sup>1</sup>
200	4	2	8	3	8	Outdoor (NEMA 3R)	Surface	None	OH/UG	UL	TSM420CSCU <sup>1</sup>
200	8	4	16	6	16	Outdoor (NEMA 3R)	Surface	None	OH/UG	UL	TSM820CSCU <sup>1</sup>
200	8	4	16	6	16	Outdoor (NEMA 3R)	Surface	None	OH/UG	UL	TSM820CSFL <sup>1</sup>

<sup>1</sup>Devices include removable closing cap. Order hub separately. See page 1-27.

#### Application Data

Product Number	Box Number	Unit Width (in inches)	Unit Height (in inches)	Depth (in inches)	Factory Inst. Svcs Disc	Main Wire Size (AWG/kcmil) Cu-Al	Equipment Ground Kit
TSM415CSCU	R36	14	28-1/2	4-1/2	THQMV	6-350	TGL2 included
TSM815CSCU	R16	16-3/4	33	6-3/16	THQMV	1-300	TGK12 (order separately)
TSM815CSFL	R37B	14	31-3/4	4-1/2	THQMV	6-350	TGK24 included
TSM420CSCU	R36	14	28-1/2	4-1/2	THQMV	6-350	TGL2 included
TSM820CSCU	R16	16-3/4	33	6-3/16	THQMV	6-350	TGK12 (order separately)
TSM820CSFL	R37B	14	31-3/4	4-1/2	THQMV	6-350	TGK24 included



# Load Centers and Circuit Breakers

## PowerMark Gold Meter Socket Load Centers

### Single-Phase, Three-Wire, 120/240 Vac

With Bonded Neutrals

# Section 1

Meter Socket LC  
1PH  
Ring Type  
Narrow, Wide, Over/Under  
Main Breaker  
NEMA 3R

### Ring Type - Side by Side - Main Breaker - OH/UG

Main Ampere Rating	1 Pole, 1" Spaces	2 Pole, 1" Spaces	1 Pole, 1/2" Spaces	2 Pole, 1/2" Spaces	Total 1-pole Spaces	Enclosure Type	Front Type	Bypass Type	UL Incoming	Agency Certification	Product Number
100	16	8	32	14	32	Outdoor	Semi-Flush	None	OH/UG	UL/EUSERC	TSM1610CFCU <sup>1</sup>
125	12	6	24	12	24	Outdoor	Semi-Flush	None	OH/UG	UL/EUSERC	TSM1212CFCU <sup>1</sup>
125	16	8	32	14	32	Outdoor	Semi-Flush	None	OH/UG	UL/EUSERC	TSM1612CFCU <sup>1</sup>
200	20	10	40	18	40	Outdoor	Semi-Flush	None	OH/UG	UL/EUSERC	TSM2020CFCU <sup>1</sup>
100	16	8	32	14	32	Outdoor	Surface	None	OH/UG	UL/EUSERC	TSM1610CSCU <sup>1,2,3</sup>
125	12	6	24	12	24	Outdoor	Surface	None	OH/UG	UL/EUSERC	TSM1212CSCU <sup>1,2,3</sup>
125	16	8	32	14	32	Outdoor	Surface	None	OH/UG	UL/EUSERC	TSM1612CSCU <sup>1,2,3</sup>
200	20	10	40	18	40	Outdoor	Surface	None	OH/UG	UL/EUSERC	TSM2020CSCU <sup>1,2,3</sup>

<sup>1</sup>Accepts field installed fifth jaw terminal in the 3 or 9 o'clock position. Product number TJAW53; order separately.

<sup>2</sup>Devices include removable closing cap. Order hub separately. See page 1-27.

<sup>3</sup>Surface mounted units have two hub provisions on top end wall.

### Application Data

Product Number	Box Number	Unit Width (in inches)	Unit Height (in inches)	Depth (in inches)	Factory Inst. Svcs Disc	Main Wire Size (AWG/kcmil) Cu-Al	Equipment Ground Kit
TSM1610CFCU	R19	14-3/4	28-1/2	7-5/16	THHQL	12-2/0	TGK12 (order separately)
TSM1212CFCU	R19	14-3/4	28-1/2	7-5/16	THHQL	12-2/0	TGK12 (order separately)
TSM1612CFCU	R19	14-3/4	28-1/2	7-5/16	THHQL	12-2/0	TGK12 (order separately)
TSM2020CFCU	R17	16-3/4	34-1/4	7-5/16	THQMV	1-300	TGK12 (order separately)
TSM1610CSCU	R20	14-3/4	27-5/16	5-7/16	THHQL	12-2/0	TGK12 (order separately)
TSM1212CSCU	R20	14-3/4	27-5/16	5-7/16	THHQL	12-2/0	TGK12 (order separately)
TSM1612CSCU	R20	14-3/4	27-5/16	5-7/16	THHQL	12-2/0	TGK12 (order separately)
TSM2020CSCU	R18	14-3/4	33	6-5/16	THQMV	1-300	TGK12 (order separately)

### Ring Type - Extra Wide - Main Breaker

Main Ampere Rating	1 Pole, 1" Spaces	2 Pole, 1" Spaces	1 Pole, 1/2" Spaces	2 Pole, 1/2" Spaces	Total 1-pole Spaces	Enclosure Type	Front Type	Bypass Type	UL Incoming	Agency Certification	Product Number
200	32	16	16	6	40	Outdoor	Surface	None	UG	UL/EUSERC	TSM3220UWCU <sup>2</sup>
200	40	20	0	0	40	Outdoor	Surface	None	UG	UL/EUSERC	TSM4020UWCU <sup>2</sup>

<sup>2</sup>Devices include removable closing cap. Order hub separately. See page 1-27.

### Application Data

Product Number	Box Number	Unit Width (in inches)	Unit Height (in inches)	Depth (in inches)	Factory Inst. Svcs Disc	Main Wire Size (AWG/kcmil) Cu-Al	Equipment Ground Kit
TSM3220UWCU	R28	22-1/2	27-7/8	6-1/4	THQMV	1-300	TGK12 (order separately)
TSM4020UWCU	R29	22-1/2	34-7/8	6-1/4	THQMV	1-300	TGK12 (order separately)

### Ring Type - Top/Bottom - Main Breaker

Main Ampere Rating	1 Pole, 1" Spaces	2 Pole, 1" Spaces	1 Pole, 1/2" Spaces	2 Pole, 1/2" Spaces	Total 1-pole Spaces	Enclosure Type	Front Type	Bypass Type	UL Incoming	Agency Certification	Product Number
200	24	12	36	18	42	Outdoor	Semi-Flush	None	UG	UL/EUSERC	TSM2420UF42 <sup>1</sup>
200	32	14	16	6	40	Outdoor	Semi-Flush	None	UG	UL/EUSERC	TSM3220UFCU
225	20	10	40	18	40	Outdoor	Semi-Flush	None	UG	UL/EUSERC	TSM2022UFCU
225	32	14	16	6	40	Outdoor	Semi-Flush	None	UG	UL/EUSERC	TSM3222UFCU
200	24	12	36	18	42	Outdoor	Surface	None	UG	UL/EUSERC	TSM2420US42 <sup>1,2,3</sup>
200	32	14	16	6	40	Outdoor	Surface	None	UG	UL/EUSERC	TSM3220USCU <sup>1</sup>
225	20	10	40	18	40	Outdoor	Surface	None	UG	UL/EUSERC	TSM2022USCU <sup>1</sup>
225	32	14	16	6	40	Outdoor	Surface	None	UG	UL/EUSERC	TSM3222USCU <sup>1</sup>

<sup>1</sup>Accepts field installed fifth jaw terminal in the 3 or 9 o'clock position. Product number TJAW53; order separately.

<sup>2</sup>Devices include removable closing cap. Order hub separately. See page 1-27.

<sup>3</sup>Surface mounted units have two hub provisions on top end wall.

### Application Data

Product Number	Box Number	Unit Width (in inches)	Unit Height (in inches)	Depth (in inches)	Factory Inst. Svcs Disc	Main Wire Size (AWG/kcmil) Cu-Al	Equipment Ground Kit
TSM2420UF42	R17	16-3/4	34-1/4	7-5/16	THQMV	1-4/0	TGK12 (order separately)
TSM3220UFCU	R27	14-9/16	43-5/8	7-3/16	THQMV	1-300	TGK12 (order separately)
TSM2022UFCU	R21	14-9/16	43-5/8	7-3/16	THQMV	1-300	TGK12 (order separately)
TSM3222UFCU	R22	16-3/16	48-1/8	7-3/16	THQMV	1-300	TGK12 (order separately)
TSM2420US42	R17	16-3/4	34-1/4	7-5/16	THQMV	1-4/0	TGK12 (order separately)
TSM3220USCU	R27	14-9/16	48-1/8	6-3/16	THQMV	1-300	TGK12 (order separately)
TSM2022USCU	R26	14-9/16	43-5/8	6-3/16	THQMV	1-300	TGK12 (order separately)
TSM3222USCU	R27	14-9/16	48-1/8	6-3/16	THQMV	1-300	TGK12 (order separately)



# Load Centers and Circuit Breakers

## PowerMark Gold Meter Socket Load Centers

### Single-Phase, Three-Wire, 120/240 Vac

With Bonded Neutrals

## Section 1

Meter Socket LC

1PH

Ringless with Bypass

Xcel Energy

NEMA 3R

### Ringless with Bypass - Xcel Energy

Main Ampere Rating	1 Pole, 1" Spaces	2 Pole, 1" Spaces	1 Pole, 1/2" Spaces	2 Pole, 1/2" Spaces	Total 1-pole Spaces	Enclosure Type	Main Type	Front Type	Bypass Type	UL Incoming	Agency Certification	Product Number
125	4	2	8	3	8	Outdoor (NEMA 3R)	MLO	Surface	Horn Bypass	OH/UG	Xcel/UL	TSLR412CSCU <sup>1</sup>
125	4	2	6	3	6	Outdoor (NEMA 3R)	MLO	Surface <sup>1</sup>	Lever Bypass	OH/UG	Xcel/UL	TSLB412CSCU <sup>1</sup>
125	12	6	24	10	24	Outdoor (NEMA 3R)	MB	Surface	Horn Bypass	OH/UG	Xcel/UL	TSMR1212CSCU <sup>1</sup>
125	12	6	24	12	24	Outdoor (NEMA 3R)	MB	Surface	Lever Bypass	OH/UG	Xcel/UL	TSMB1212CSCU <sup>1</sup>
150	4	2	8	3	8	Outdoor (NEMA 3R)	MB	Surface	Horn Bypass	OH/UG	Xcel/UL	TSMR415CSCU
150	20	10	40	18	40	Outdoor (NEMA 3R)	MB	Surface	Horn Bypass	OH/UG	Xcel/UL	TSMR2015CSCU <sup>1</sup>
150	20	10	40	18	40	Outdoor (NEMA 3R)	MB	Surface	Lever Bypass	OH/UG	Xcel/UL	TSMB2015CSCU <sup>1</sup>
200	4	2	6	3	6	Outdoor (NEMA 3R)	MLO	Surface <sup>1</sup>	Lever Bypass	OH/UG	Xcel/UL	TSLB420CSCU <sup>1</sup>
200	4	2	8	3	8	Outdoor (NEMA 3R)	MLO	Surface	Horn Bypass	OH/UG	Xcel/UL	TSLR420CSCU <sup>1</sup>
200	4	2	8	3	8	Outdoor (NEMA 3R)	MB	Surface	Horn Bypass	OH/UG	Xcel/UL	TSMR420CSCU
200	20	10	40	18	40	Outdoor (NEMA 3R)	MB	Surface	Horn Bypass	OH/UG	Xcel/UL	TSMR2020CSCU <sup>1</sup>
200	20	10	40	18	40	Outdoor (NEMA 3R)	MB	Surface	Lever Bypass	OH/UG	Xcel/UL	TSMB2020CSCU <sup>1</sup>

<sup>1</sup>Devices include removable closing cap. Order hub separately. See page 1-27.

### Application Data

Product Number	Box Number	Unit Width (in inches)	Unit Height (in inches)	Depth (in inches)	Factory Inst. Svcs Disc	Main Wire Size (AWG/kcmil) Cu-Al	Equipment Ground Kit
TSLR412CSCU	R31	14-9/16	33-9/16	6-3/16	Field Installed <sup>2</sup>	6-350	TGK12 (order separately)
TSLB412CSCU	R12	14	23-1/2	4-7/8	Field Installed <sup>2</sup>	6-350	TGL1 installed
TSMR1212CSCU	R30	14-9/16	40-1/2	6-3/16	THHQL	6-350	TGK12 (order separately)
TSMB1212CSCU	R20	14-3/4	27-5/16	5-7/16	THHQL	12-2/0	TGK12 (order separately)
TSMR415CSCU	R31	14-9/16	33-9/16	6-3/16	THQMV	6-350	TGK12 installed
TSMR2015CSCU	R30	14-9/16	40-1/2	6-3/16	THQMV	6-350	TGK12 (order separately)
TSMB2015CSCU	R18	14-3/4	33	6-5/16	THQMV	1-300	TGK12 (order separately)
TSLB420CSCU	R14	14	30-3/4	5-3/4	Field Installed <sup>2</sup>	6-350	TGL1 installed
TSLR420CSCU	R31	14-9/16	33-9/16	6-3/16	Field Installed <sup>2</sup>	6-350	TGK12 (order separately)
TSMR420CSCU	R31	14-9/16	33-9/16	6-3/16	THQMV	6-350	TGK12 installed
TSMR2020CSCU	R30	14-9/16	40-1/2	6-3/16	THQMV	6-350	TGK12 (order separately)
TSMB2020CSCU	R18	14-3/4	33	6-5/16	THQMV	1-300	TGK12 (order separately)

<sup>2</sup>THQL and THHQL only. 125 amp max. TQDL is obsolete.



# Load Centers and Circuit Breakers

## PowerMark Gold Meter Socket Load Centers

### Single-Phase, Three-Wire, 120/240 Vac

With Bonded Neutrals

# Section 1

Meter Socket LC  
1PH  
Ringless  
Georgia Power  
Florida Meter Group  
Main Breaker  
NEMA 3R

#### Georgia Power Ringless - Main Breaker

Main Ampere Rating	1 Pole, 1" Spaces	2 Pole, 1" Spaces	1 Pole, 1/2" Spaces	2 Pole, 1/2" Spaces	Total 1-pole Spaces	Enclosure Type	Front Type	Bypass Type	UL Incoming	Agency Certification	Product Number
150	-	-	-	-	-	Outdoor (NEMA 3R)	Surface	None	OH/UG	UL/GP	TSMR015CSGP <sup>1,4</sup>
200	-	-	-	-	-	Outdoor (NEMA 3R)	Surface	None	OH/UG	UL/GP	TSMR020CSGP <sup>1,4</sup>
150	4	2	8	3	8	Outdoor (NEMA 3R)	Surface	None	OH/UG	UL/GP	TSMR415CSCUGP <sup>1,4</sup>
200	4	2	8	3	8	Outdoor (NEMA 3R)	Surface	None	OH/UG	UL/GP	TSMR420CSCUGP <sup>1,4</sup>

#### Application Data

Product Number	Box Number	Unit Width (in inches)	Unit Height (in inches)	Depth (in inches)	Factory Inst. Svcs Disc	Main Wire Size (AWG/kcmil) Cu-Al	Equipment Ground Kit
TSMR015CSGP	R32A	18-7/8	18-9/16	5	THQD	2-250	-
TSMR020CSGP	R32A	18-7/8	18-9/16	5	THQD	2-250	-
TSMR415CSCUGP	R40	14	32	4-1/2	THQMV	6-350	TGL2 included
TSMR420CSCUGP	R40	14	32	4-1/2	THQMV	6-350	TGL2 included

#### Florida Meter Group MSLC Ringless - Main Breaker

Main Ampere Rating	1 Pole, 1" Spaces	2 Pole, 1" Spaces	1 Pole, 1/2" Spaces	2 Pole, 1/2" Spaces	Total 1-pole Spaces	Enclosure Type	Front Type	Bypass Type	UL Incoming	Agency Certification	Product Number
150	4	2	8	3	8	Outdoor (NEMA 3R)	Surface	None	OH/UG	UL/FMG	TSMR415CSFLFMG
200	4	2	8	3	8	Outdoor (NEMA 3R)	Surface	None	OH/UG	UL/FMG	TSMR420CSFLFMG
150	8	4	16	6	16	Outdoor (NEMA 3R)	Surface	None	OH/UG	UL/FMG	TSMR815CSFLFMG <sup>4</sup>
200	8	4	16	6	16	Outdoor (NEMA 3R)	Surface	None	OH/UG	UL/FMG	TSMR820CSFLFMG <sup>4</sup>
200	20	4	40	18	40	Outdoor (NEMA 3R)	Surface	None	OH/UG	UL/FMG	TSMR2020CSCUFMG <sup>2</sup>

#### Application Data

Product Number	Box Number	Unit Width (in inches)	Unit Height (in inches)	Depth (in inches)	Factory Inst. Svcs Disc	Main Wire Size (AWG/kcmil) Cu-Al	Equipment Ground Kit
TSMR415CSFLFMG	R36A	14	28-1/2	4-1/2	THQMV	6-350	TGL2 included
TSMR420CSFLFMG	R36A	14	28-1/2	4-1/2	THQMV	6-350	TGL2 included
TSMR815CSFLFMG	R37A	14	31-3/4	4-1/2	THQMV	6-350	TGK24 included
TSMR820CSFLFMG	R37A	14	31-3/4	4-1/2	THQMV	6-350	TGK24 included
TSMR2020CSCUFMG	R40 <sup>3</sup>	14	34-1/2	4-1/2	THQMV	6-350	TGK24 included

<sup>1</sup>Use FMG unit if Ringless standard UL design is required by your local utility.

<sup>2</sup>No feed through lugs.

<sup>3</sup>Knock outs are the same as R36A.

<sup>4</sup>Feed-thru lugs provided.





# Load Centers and Circuit Breakers

## PowerMark Gold Meter Socket Load Centers

### Single-Phase, Three-Wire, 120/240 Vac

With Bonded Neutrals

# Section 1

Meter Socket LC  
1PH  
Class 320  
NEMA 3R

### Class 320

Main Ampere Rating	1 Pole, 1" Spces	2 Pole, 1" Spces	1 Pole, 1/2" Spces	2 Pole, 1/2" Spces	Total 1-pole Spces	Enclosure Type	Front Type	Bypass Type	UL Incoming	Agency Certification	Product Number
320	24	12	32	14	40	Outdoor (NEMA 3R)	Surf/Semi	None	UG	UL	TM2432RMS <sup>1,2,3</sup>
400	0	0	0	0	0	Outdoor (NEMA 3R)	Surf/Semi	Lever Bypass	UG	UL	TSDR040UFCU <sup>4</sup>
300	8	4	16	6	16	Outdoor (NEMA 3R)	Surface	Lever Bypass	UG	UL FMG	TSDR830USCU <sup>4</sup>
400	8	4	16	6	16	Outdoor (NEMA 3R)	Surface	Lever Bypass	UG	UL FMG	TSDR840UFCU <sup>4</sup>
400	24	12	32	14	40	Outdoor (NEMA 3R)	Surf/Semi	K-4 Bolt-In Meter Provision	UG	UL	TM2440RMKS <sup>1,2,3</sup>
400	24	12	32	14	40	Outdoor (NEMA 3R)	Surf/Semi	Lever Bypass	UG	UL	TM2440RMS <sup>1,2,3</sup>
400	24	12	32	14	40	Outdoor (NEMA 3R)	Surf/Semi	None	UG	UL EUSERC	TM2440RMS <sup>1,2,3</sup>
400	24	12	32	14	40	Outdoor (NEMA 3R)	Surf/Semi	Lever Bypass	UG	UL Xcel	TMH2440RMRS <sup>1,2,3,4</sup>
400	24	12	32	14	40	Outdoor (NEMA 3R)	Surf/Semi	None	UG	UL	TMH2440RMS <sup>1,2,3,4</sup>
320	0	0	0	0	0	Outdoor (NEMA 3R)	Surf/Semi	Lever Bypass	UG	UL	TSD032UFCU <sup>4</sup>
320	24	12	32	14	42	Outdoor (NEMA 3R)	Surf/Semi	Link Bypass	UG	UL EUSERC	TSDA2432UC4 <sup>2,4</sup>
400	24	12	32	14	42	Outdoor (NEMA 3R)	Surf/Semi	Link Bypass	UG	UL EUSERC	TSDA2440UC4 <sup>2,4</sup>

<sup>1</sup>200A main breaker factory installed. Space provided for field mounted TQD-WL sub feed.

<sup>2</sup>For semi-flush applications, order surface enclosure load center and field installed kit, Product number SF400.

<sup>3</sup>Stud provisions only provided.

<sup>4</sup>22 kAIC.

### Application Data

Product Number	Ringless	Box Number	Unit Width (in inches)	Unit Height (in inches)	Depth (in inches)	Factory Inst. Main Breaker	Field Inst. Main Breaker	Main Wire Size (AWG/kcmil) Cu-Al	Equipment Ground Kit
TM2432RMS	No	R24	30-1/4	40	6	TQD	THQL	(1) 800 or (2) 400 compression type; (1) 1000 or (2) compression type; (1) 1000 or (2) 350 pressure type	(2) TGL2 (order separately)
TM2440RMS	No	R24	30-1/4	40	6	TQD	TQD	(1) 800 or (2) 400 compression type; (1) 1000 or (2) 350 pressure type	(2) TGL2 (order separately)
TMH2440RMS	No	R24	30-1/4	40	6	THQD	THQD	(1) 800 or (2) 400 compression type; (1) 1000 or (2) 350 pressure type	(2) TGL2 (order separately)
TSDA2432UC42	No	R24	30-1/4	40	6	THQD	THQL/THHQL	(1) 800 or (2) 400 compression type	(2) TGL2 (order separately)
TSDA2440UC42	No	R24	30-1/4	40	6	THQD	TQD/THQD	(1) 800 or (2) 400 compression type	(2) TGL2 (order separately)
TSD032UFCU	No	R33	30-1/4	33	6-3/32	THQD	THQL/THHQL	(1) 800 or (2) 400 compression type	(2) TGL2 (order separately)
TM2440RMKS	Yes	R23	30-1/4	40	6	TQD	TQD	(1) 800 or (2) 400 compression type; (1) 1000 or (2) 350 pressure type	(2) TGL2 (order separately)
TM2440RMRS	Yes	R24	30-1/4	40	6	TQD	TQD	(1) 800 or (2) 400 compression type; (1) 1000 or (2) 350 pressure type	(2) TGL2 (order separately)
TMH2440RMRS	Yes	R24	30-1/4	40	6	THQD	THQD	(1) 800 or (2) 400 compression type; (1) 1000 or (2) 350 pressure type	(2) TGL2 (order separately)
TSDR040UFCU	Yes	R33	30-1/4	33	6-3/32	THQD	TQD/THQD	(1) 800 or (2) 400 compression type	(2) TGL2 (order separately)
TSDR840UFCU	Yes	R33	30-1/4	33	6-3/32	THQD	TQD/THQD	(1) 800 or (2) 400 compression type	(2) TGL2 (order separately)



# Load Centers and Circuit Breakers

## PowerMark Gold and Plus Load Centers

### Circuit Breakers

## Section 1

#### Field Installed Accessories

#### PowerMark Gold Main Circuit Breaker Kit

For use with 125A PowerMark Gold load Centers; 22kAIC RMS symmetrical.

Description	Product Number
Main Circuit Breaker Kit - Order appropriate THQL 10kAIC or THHQL 22kAIC breakers separately	TQMH000 <sup>1</sup>

<sup>1</sup>Please review the footnotes listed with the individual Load Center product numbers for proper parts needed to convert to a main circuit breaker. This main breaker base is only applicable for 16 circuit and larger 125 amp load centers, 12 circuit load centers with A C24 suffix, and the TLM812RCU2.

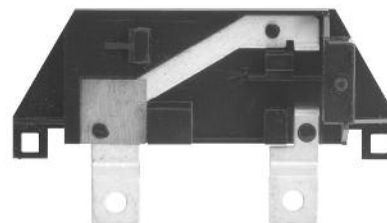

TQMH000

#### PowerMark Plus™ Equipment Ground Kits

Description	Standard Package Quantity	Product Number
(4) 14-8Cu/12-8AL, (3) 14-4Cu/6-4AL	20	TGL1
(8) 14-8Cu/12-8AL, (6) 14-4Cu/6-4AL	20	TGL2 <sup>1</sup>
(7) 14-8Cu/12-8AL, (3) 14-4Cu/6-4AL, (2) 14-4Cu/12-4AL, (1) 14-2Cu/AL	20	TGL8 <sup>1</sup>
(1) 6-2/0Cu/Al Number of Terminals, Equipment Ground Kits	20	TGL20 <sup>2</sup>
(3) 10-1/0 Cu/Al Number of Terminals for 400 and 600 Amp	1	TNG3 <sup>3</sup>
(6) 10-1/0 Cu/Al Number of Terminals for 400 and 600 Amp	1	TNG6 <sup>4</sup>

<sup>1</sup>TGL2, TGL4 and TGL8 mount interchangeably

<sup>2</sup>Add-on Equipment Ground Lug (for use on any TGL Kit)

<sup>3</sup>Suitable for use with up to six TPLUG108 lugs or six crimp lugs per pole



TGL2

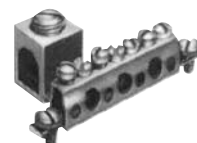

TGL20 combined with TGL1

#### PowerMark Gold Equipment Ground and Isolated Ground Bar Kits<sup>4,5</sup>

Description	Standard Package Quantity	Product Number
4-hole Ground	1	TGK4
12-hole Ground	1	TGK12
24-hole Ground	1	TGK24
32-hole Ground	1	TGK32
42-hole Ground	1	TGK42

<sup>4</sup>6-12 circuit indoor load centers use PowerMark Plus style neutrals and grounds

<sup>5</sup>Add TGKIS for isolated ground and mount to ground kit.



TGK12



TGK12 with TGKIS



# Load Centers and Circuit Breakers

## PowerMark Gold and Plus Load Centers

### Circuit Breakers

## Section 1

#### Field Installed Accessories

#### PowerMark Plus™ Neutral Kits

Description	Wire Range	Standard Package Quantity	Product Number
400 & 600 Amp PowerMark Plus™ Neutral Kit	(5) 14-1/0	1	TNLK1 <sup>1</sup>
400 & 600 Amp PowerMark Plus™ Neutral Kit	(3) 1-300	1	TNLK2 <sup>1</sup>
Add-on neutral lug for 100-200 Amp PowerMark Plus load centers	6-2/0	1	286A8894G1
Add-on neutral lug for 100-200 Amp PowerMark Plus load centers	1-300 Cu or 2/0-300 Al	1	192A7663G13

<sup>1</sup>Suitable for use with up to six TPLUG108 lugs or six crimp lugs per pole



192A7663G13



286A8894G1

#### PowerMark Gold Neutral Kits

Description	Wire Range	Standard Package Quantity	Product Number
PowerMark Gold Neutral Kit - Mounted on top of neutral only	6-2/0	1	TNLK20
PowerMark Gold Neutral Kit - Mounted on top of neutral only	6-250	1	TNLK250



TNLK250

#### PowerMark Gold Neutral/Ground Lug Kits

Mounted on any neutral or ground position by removing the termination screw

Description	Wire Range	Standard Package Quantity	Product Number
Neutral/Ground Lug Kit	6-2/0	1	TLK20
Neutral/Ground Lug Kit	6-250	1	TLK250
Neutral/Ground Lug Kit	6-300	1	TLK300



TLK20



TLK250

#### Isolated Ground Bus Bars Equipment Ground Kit

Description	Standard Package Quantity	Product Number
Isolated Ground Bar Kit (order with TGK Equipment Ground Kits)	1	TGKIS
Isolated Ground Bar Feet (Order with TGK8)	1	TGKIS2



TGK12 with TGKIS

#### Subfeed Lug Kits

Description	Standard Package Quantity	Product Number
125A 2 Pole Plug-in	1	THLK2125
150A 2 Pole Plug-in - For use with PowerMark Gold only	1	THLK2150
200A 2 Pole Plug-in - For use with PowerMark Gold only	1	THLK2200
125A 3 Pole Plug-in	1	THLK3125
225A 3 Pole Plug-in - For use with 3 phase only	1	THLK3225

#### Sub-feed and Feed-thru Lugs

UL Listed

For use in load centers to economically supply power to a subpanel.

Poles	Ampere Rating	Product Number
2	125	THLK2125
3	125	THLK3125
2	150	THLK2150 <sup>1</sup>
2	200	THLK2200 <sup>1</sup>
3	225	THLK3225 <sup>2</sup>

<sup>1</sup>For use with PowerMark Gold load centers only

<sup>2</sup>For use with three-phase load centers only. Includes mounting base.



THLK2125



# Load Centers and Circuit Breakers

## PowerMark Gold and Plus Load Centers

### Circuit Breakers

## Section 1

#### Field Installed Accessories

#### PowerMark Plus™ Main Lug Kits

Description	Wire Range (Cu/Al)	Product Number
150 Amp PowerMark Plus™ Replacement Main Lug kit	2-3/0	THLK150
200 Amp PowerMark Plus™ Replacement Main Lug kit	1-250	THLK200



THLK200

#### PowerMark Gold Main Lug Kits

Description	Wire Range (Cu/Al)	Product Number
125 Amp PowerMark Gold Replacement Main Lug kit	6-2/0	TMLK125
200 Amp PowerMark Gold Replacement Main Lug kit	6-250	TMLK200
225 Amp PowerMark Gold Replacement Main Lug kit	6-300	TMLK225

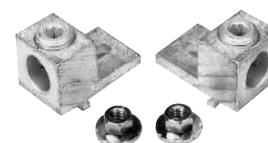

PowerMark Gold main lug kits - TMLK200

For replacement of main lugs on 125 amp load centers; TLM load centers include main lugs.

#### Door Lock

Description	Standard Package Quantity	Product Number
For indoor load centers larger than 12 circuits (Does not fit TPL412)	10	TDL106



TDL106

#### Circuit Directory

Description	Standard Package Quantity	Product Number
Card and holder with pressure-sensitive backing. Mounts inside the door.	1	TD42



TD42

#### Touch-up Paint

Description	Standard Package Quantity	Product Number
12 3/4 oz. spray can of light gray enamel	1	TSP61



TSP61



# Load Centers and Circuit Breakers

## PowerMark Gold and Plus Load Centers

### Circuit Breakers

#### Field Installed Accessories

#### Front Filler Plates

Description	Standard Package Quantity	Product Number
1/2" Front Filler Plate	100	TFH
1" Front Filler Plate	50	TQLFP1

Covers 1/2" rectangular breaker knockouts  
Covers 1" rectangular breaker knockouts



TFH

#### Universal Raintight Hubs

Description	Base Size (in.)	Standard Package Quantity	Product Number
3/4" Diameter	3	10	TC75
1" Diameter	3	10	TC100
1-1/4" Diameter	3	10	TC125
1-1/2" Diameter	3	10	TC150
2" Diameter	3	10	TC200
2-1/2" Diameter	3	10	TC250
3" Diameter	3	5	TC300
Closing Cap	3	10	TCCP
2" Diameter	4		TCU27
2-1/2" Diameter	4		TCU28
3" Diameter	4		TCU30
3-1/2" Diameter	4		TCU35
4" Diameter	4		TCU40 <sup>1</sup>
4" Cover Plate	4		TCUP

<sup>1</sup>For 40 and 42 circuit units in R8 boxes only.



TC150

#### Door Handle

Description	Standard Package Quantity	Product Number
Replacement Door Handle Universal	1	TRL22



TRL22

#### PowerMark Gold Cross Arm

Description	Standard Package Quantity	Product Number
Replacement cross arm for PowerMark Gold load centers	1	LCCROSSARM



LCCROSSARM



# Load Centers and Circuit Breakers

## PowerMark Gold and Plus Load Centers

### Circuit Breakers

## Section 1

#### Field Installed Accessories

#### PowerMark Gold Main Breaker Retainers

Description	Breaker Type	Product Number
Travel Trailer Main Breaker Retainer Kit for THQP Breakers	THQP	THQPSBK
For use on PowerMark Plus™ load centers with THQL Breakers 225A max	THQL	THQLRK
For use with 12 - 42 circuit PowerMark Gold load centers with THQL Breakers	THQL	THQLRK1
For use with 6 - 8 circuit PowerMark Gold load centers with THQL Breakers	THQL	THQLRK2
For use with TM/TLM1212CCU Mod 2 current model	THQL	THQLRK3
For use with 6 - 42 circuit PowerMark Gold load centers with THQL Breakers. Similar to THQLRK1 but it does not take up a breaker space.	THQL	THQLRK4

For main lug load centers utilizing a back fed branch breaker as a main



THQLRK



THQLRK1

#### Handle Locks - Padlocking

Description	Breaker Type	Product Number
THQP Padlocking Handle Lock	THQP	TQPPL
THQL Padlocking Handle Lock	THQL	THP100
TQD Padlocking Handle Lock	TQD	TQDPLD1

Snap on handle lock  
Padlock not included

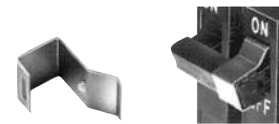

THL103

#### Handle Locks - Non Padlocking

Description	Breaker Type	Product Number
THQP Non Padlocking Handle Lock	THQP	TQPL
THQL Non Padlocking Handle Lock	THQL	THL103

Snap on handle lock

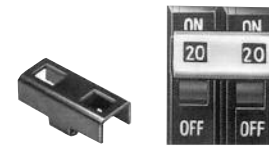

THT1

#### Handle Ties

Description	Breaker Type	Product Number
Handle Ties for THQP Breakers - Solid Snap-on Trip Indicating	THQP	THT1 <sup>1</sup>
Handle Ties for THQP Breakers - For 2 THQPs separated by 2 side-by-side THQPs	THQP	THT2 <sup>1</sup>
Snap-on Handle Tie - Trip Indicating	TQB	TQHT1 <sup>1</sup>
	TQC	
	TQL	
Snap-on Handle Tie - Solid	TQB	THT104 <sup>1</sup>
	TQC	
	TQL	
Multiwire Branch Breaker Handle Tie Kits	TQB	TQ3HTK <sup>2</sup>
	TQC	
	TQL	

All multi-pole breakers have internal common trip  
Handle ties provide manual on-off capability only between one-pole devices

<sup>1</sup>For two single-pole breakers

<sup>2</sup>For three single-pole breakers - kit includes (10) pcs.

<sup>3</sup>For four single-pole breakers - kit includes (10) pcs.



THT104



THT2



TQHT1



# Load Centers and Circuit Breakers

## PowerMark Gold and Plus Load Centers

### Circuit Breakers

Field Installed Accessories

## Section 1

### Load Center Hardware Kits Hardware

Description	Standard Package Quantity	Product Number
PowerMark Plus™ hardware kit: TQD THQD Main or THLK main lug kit in a TLM load center, installation instructions and front mounting screws	1	LCHKIT
Powermark Gold Bond Screw Kit Screw 100 - 200A	1	TBS
Powermark Gold Bond Screw Kit 225A	1	TBS22
Powermark Gold Hardware kit containing 20 front mounting screws	1	THDWRKIT
Powermark Gold Hardware kit containing 10 interior mounting screws	1	THDWRKIT2

### Generator Interlock Kit

Description	Standard Package Quantity	Product Number
Load Center Generator Interlock Kit	1	THQLLX1
MSLC Generator Interlock Kit	1	THQLLX4
MSLC Generator Interlock Kit	1	THQLLX8CU
MSLC Generator Interlock Kit	1	THQLLX8DR
MSLC Generator Interlock Kit	1	THQLLX8FL

### PowerMark Gold Auxiliary Gutter Enclosures

Description	Product Number
24" Auxiliary Gutter Enclosure	TMAGB24
28" Auxiliary Gutter Enclosure	TMAGB28
28" Auxiliary Gutter Enclosure Flush	TMAGB28F
33" Auxiliary Gutter Enclosure	TMAGB33
39" Auxiliary Gutter Enclosure	TMAGB39
43" Auxiliary Gutter Enclosure	TMAGB43
43" Deep Auxiliary Gutter Enclosure	TMAGB43D

### PowerMark Gold Gutter Tap Kits

Description	Product Number
250 kcmil Lugs Gutter Tap Kit - one kit per phase required	TMGT250
500 kcmil Lugs Gutter Tap Kit - one kit per phase required	TMGT500
750 kcmil Lugs Gutter Tap Kit - one kit per phase required - Not for use with riser panels	TMGT750

### Meter Socket Load Center Flange Kits

Description	Product Number
Semi-Flush Kit 400A for MSLC	SF400
Semi-Flush Kit 400A for MSLC Adjustable	SF400A
Semi-Flush Kit 200A for MSLC Adjustable	SF200A

### Surge Protectors

Description	Product Number
SurgePro AC 27KA Panel-Mount Surge Protector	THQLSURGE
SurgePro AC 60kA K/O Mount Surge Protector	THSASURGE60





# Load Centers and Circuit Breakers

## PowerMark Gold and Plus Load Centers

### Circuit Breakers

# Section 1

### Wiring Diagrams

Breaker Symbol	Breaker Fill	
	1" THQL	1/2" THQP
	1	—
	1	2

Terminal Symbol	Wire Range (AWG/kcmil)	
	Cu	Al
o	14-8	12-8
•	14-4	12-4
A	6-2	6-2
B	14-1/0	12-1/0
C	6-2/0	6-2/0
D	1-300	2/0-300
E	1-300	1-300
F	6-1	6-1
G	6-3	6-3

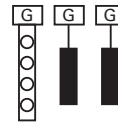

TL240SCU, RCU  
TL270SCU, RCU

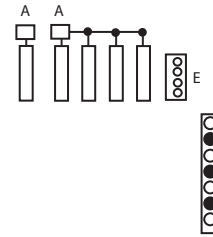

TL510RT

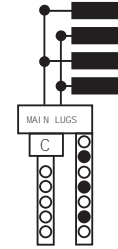

TPL412C, TL412C, TPL412R, TL412R1,  
TL412R2, TL412R250GF, TL412R260GF

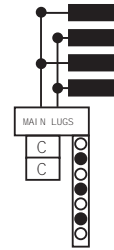

TPL412CT, TL412CT  
TPL412RT, TL412RT1

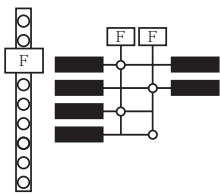

TLM612FCU, SCU  
FCUD, SCUD, RCU

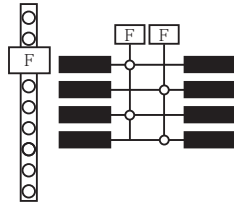

TLM812FCU, SCU,  
FCUD, SCUD, RCU

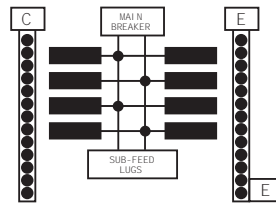

TM815RCUFL  
TM820RCUFL

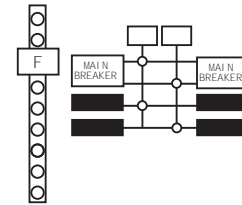

TM860FCUGEN, TLM830FCUGEN,  
TM860SCUGEN, TLM830SCUGEN,  
TM860RCUGEN, TLM830RCUGEN

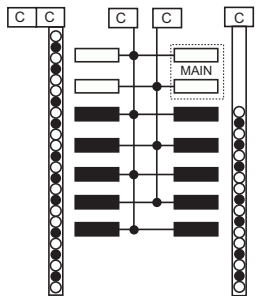

TLM1210CCU, TM1212CCU, TLM1212CCU

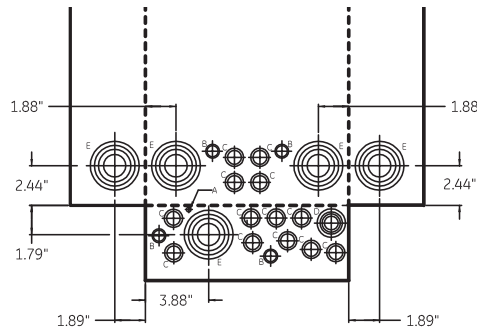

TLM1210RCU, TM1212RCU, TLM1212RCU

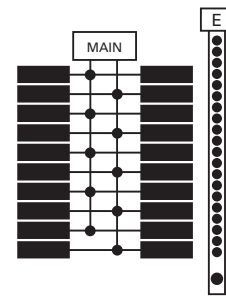

TLM2012CCURP

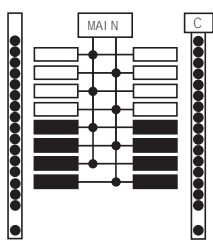

TLM1612CCU, TM1612CCU, TLM1612RCU

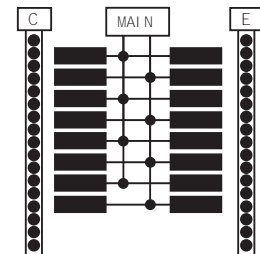

TLM1615CCU, TM1615RCU, TLM1620CCU,  
TLM1620RCU

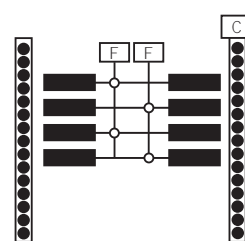

TLM812RCU2

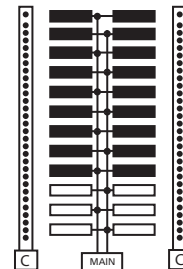

TM2420R42B



# Load Centers and Circuit Breakers

## PowerMark Gold and Plus Load Centers

### Circuit Breakers

Wiring Diagrams

# Section 1

Breaker Symbol	Breaker Fill	
	1" THQL	1/2" THQP
	1	—
	1	2

Terminal Symbol	Wire Range (AWG/kcmil)	
	Cu	Al
o	14-8	12-8
•	14-4	12-4
A	6-2	6-2
B	14-1/0	12-1/0
C	6-2/0	6-2/0
D	1-300	2/0-300
E	1-300	1-300
F	6-1	6-1
G	6-3	6-3

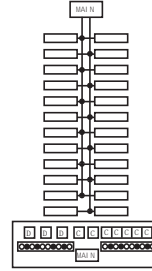

TL2440, TM2440

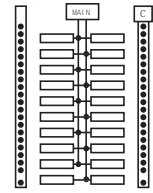

TM2010CCU, TM2010RCU

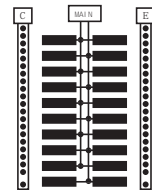

TM2020CCU, TM2020RCU  
TLM2020CCU, TLM2020RCU

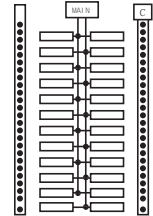

TM2410CCU, TM2412CCU  
TM2412RCU, TLM2412CCU, TLM2412RCU

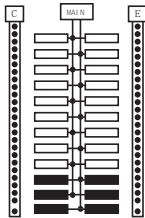

TM2415RCU, TLM2415RCU

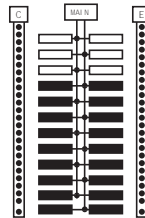

TLM2420C42, TM2415C42

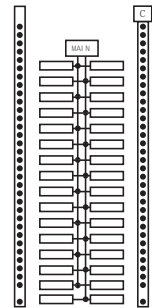

TM3210CCU

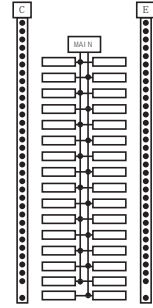

TM3215CCU, TM3215RCU

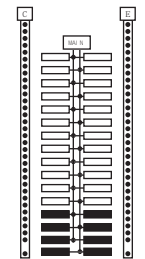

TM3220CCU, TM3220RCU, TLM3220CCU

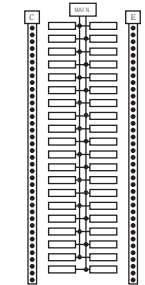

TM4020CCU, TM4020RCU  
TLM4020CCU, TLM4020RCU

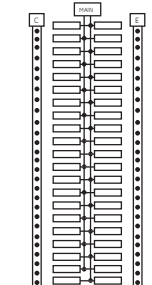

TM4222RCU, TLM4222CCU  
TLM4222RCU, TM4222CCU

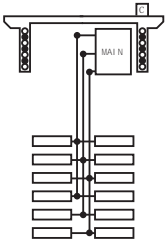

TM12410

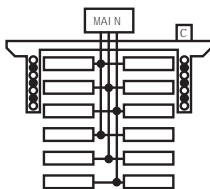

TL12412

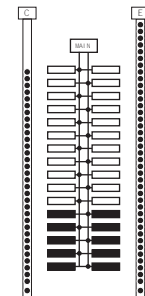

TM3215C42, TLM3220C42, TM3220C42

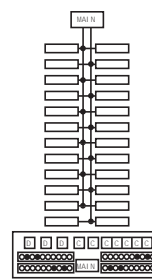

TL2460



# Load Centers and Circuit Breakers

## PowerMark Gold and Plus Load Centers

### Circuit Breakers

#### Wiring Diagrams

## Section 1

Breaker Symbol	Breaker Fill	
	1" THQL	1/2" THQP
	1	—
	1	2

Terminal Symbol	Wire Range (AWG/kcmil)	
	Cu	Al
o	14-8	12-8
•	14-4	12-4
A	6-2	6-2
B	14-1/0	12-1/0
C	6-2/0	6-2/0
D	1-300	2/0-300
E	1-300	1-300
F	6-1	6-1
G	6-3	6-3

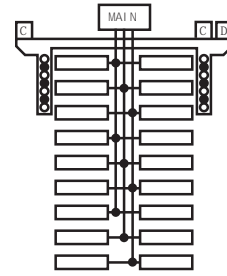

TL18415, TL18420

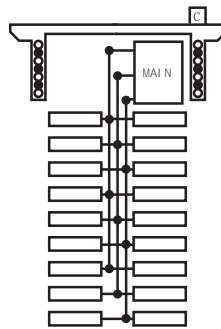

TM18410

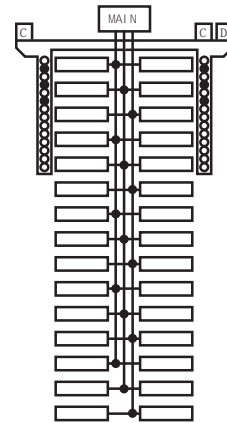

TM30412

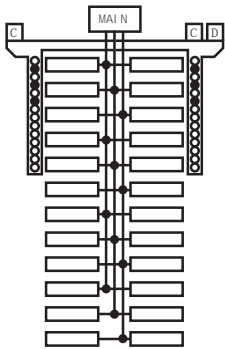

TL24415, TM24415

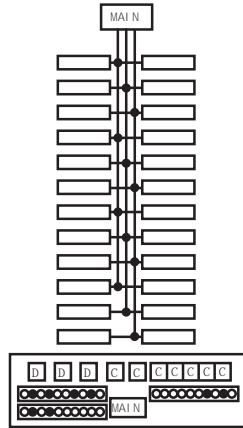

TL24440, TM24420

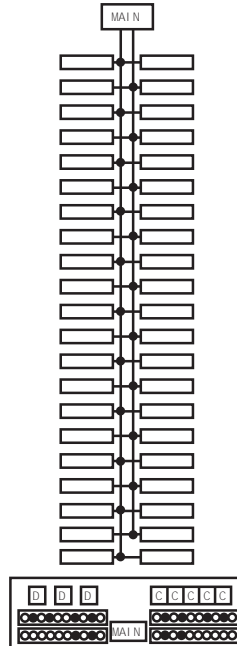

TL4260

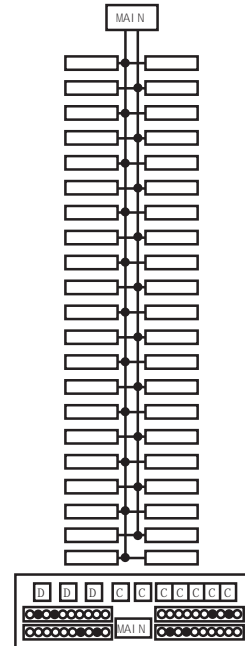

TM4240, TM4230, TL4240

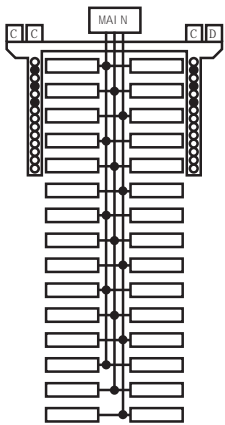

TM30415, TL30420, TM30240, TL30422

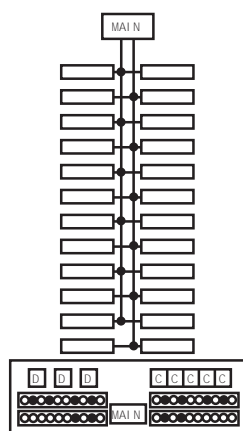

TL24460



# Load Centers and Circuit Breakers PowerMark Gold and Plus Load Centers Circuit Breakers

## Section 1

### Wiring Diagrams

Breaker Symbol	Breaker Fill	
	1" THQL	1/2" THQP
	1	—
	1	2

Terminal Symbol	Wire Range (AWG/kcmil)	
	Cu	Al
o	14-8	12-8
•	14-4	12-4
A	6-2	6-2
B	14-1/0	12-1/0
C	6-2/0	6-2/0
D	1-300	2/0-300
E	1-300	1-300
F	6-1	6-1
G	6-3	6-3

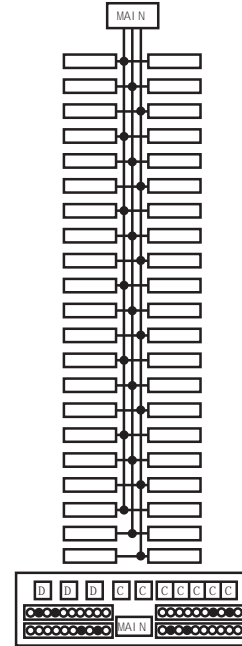

TM42430, TM42440

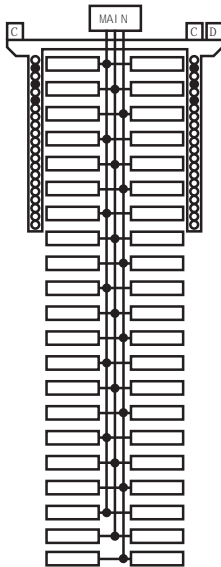

TL42420, TM42415C, TM42420

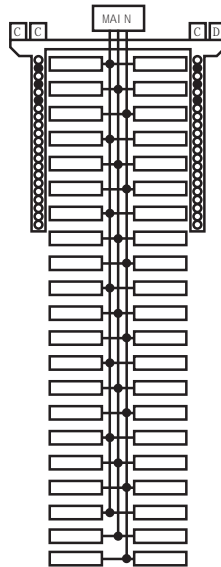

TL42422

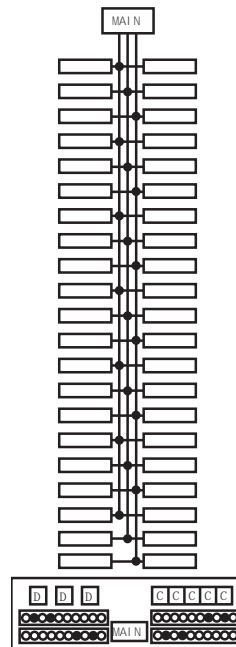

TL42440

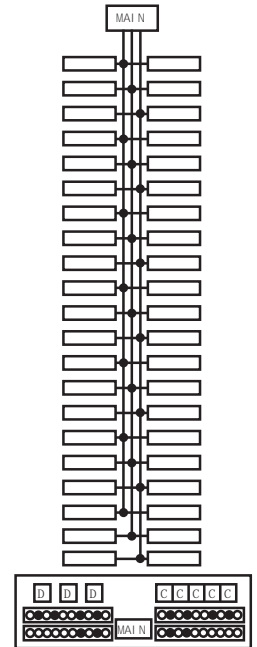

TL42460



# Load Centers and Circuit Breakers

## PowerMark Gold and Plus Load Centers

### Circuit Breakers

# Section 1

### Wiring Diagrams

Breaker Symbol	Breaker Fill	
	1" THQL	1/2" THQP
	1	—
	1	2

Terminal Symbol	Wire Range (AWG/kcmil)	
	Cu	Al
o	14-8	12-8
•	14-4	12-4
A	6-2	6-2
B	14-1/0	12-1/0
C	6-2/0	6-2/0
D	1-300	2/0-300
E	1-300	1-300
F	6-1	6-1
G	6-3	6-3

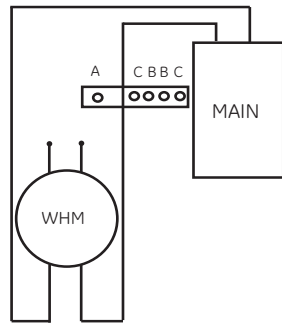

TM10RMC, TM12RMC, TM15RMC, TM20RMC,  
TSMR015CSGP, TSMR020CSGP

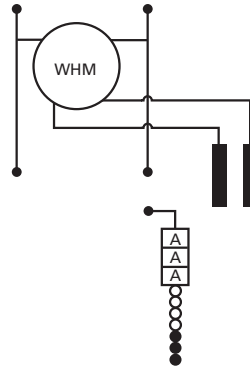

TSL210CSCU, TSL210CFCU

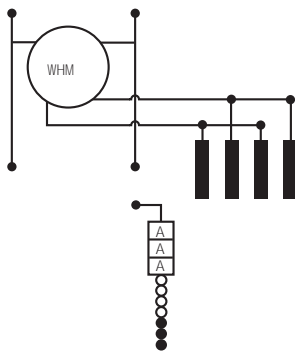

TSL412CSCU

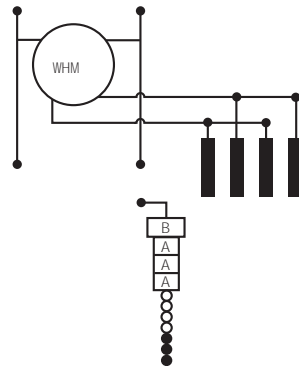

TSL420CSCU, TSL420CFCU

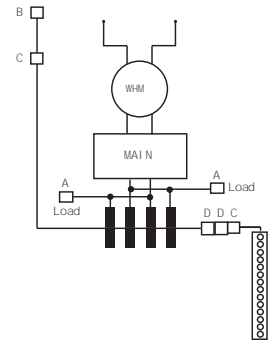

TSM415CSCU, TSM420CSCU, TSMF415CSFL,  
TSMF420CSFL, TSMR415CSCUGP, TSMR420CSCUGP,  
TSMR415CSFLFMG, TSMR420CSFLFMG

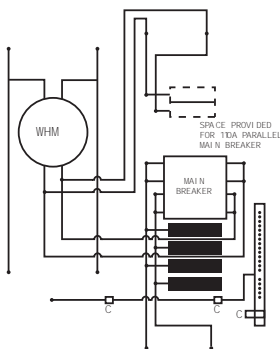

TSF420CSCU

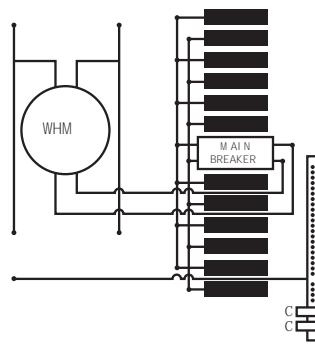

TSM1212CSCU, TSM1212CFCU

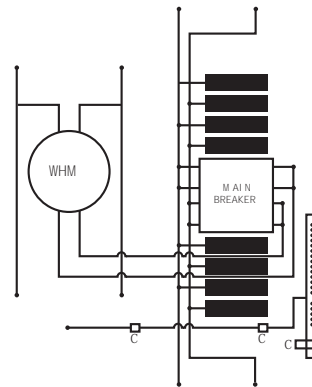

TSM815CSCU, TSM820CSCU



# Load Centers and Circuit Breakers

## PowerMark Gold and Plus Load Centers

### Circuit Breakers

# Section 1

### Wiring Diagrams

Breaker Symbol	Breaker Fill	
	1" THQL	1/2" THQP
	1	—
	1	2

Terminal Symbol	Wire Range (AWG/kcmil)	
	Cu	Al
o	14-8	12-8
•	14-4	12-4
A	6-2	6-2
B	14-1/0	12-1/0
C	6-2/0	6-2/0
D	1-300	2/0-300
E	1-300	1-300
F	6-1	6-1
G	6-3	6-3

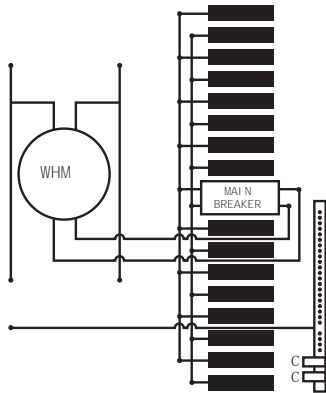

TSM1610CSCU, TSM1610CFCU, TSM1612CFCU, TSM1612CSCU

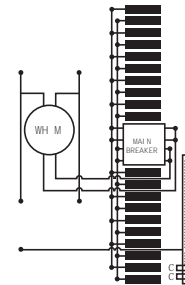

TSM2020CSCU, TSM2020CFCU

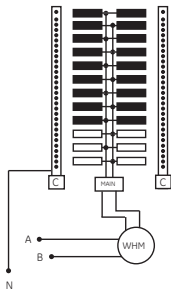

TSM2420UF42

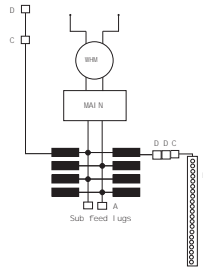

TSM815CSFL, TSM820CSFL, TSMF815CSFL,  
TSMF820CSFL, TSMR815CSFLFMG,  
TSMR820CSFLFMG

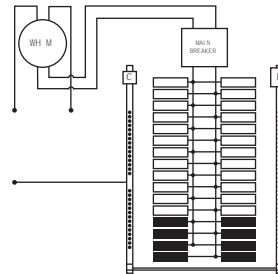

TSM3220UWCU

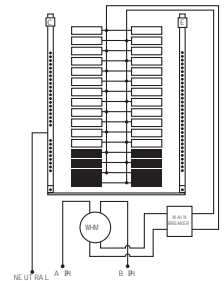

TSM3220USCU, TSM3220UF42, TSM3222USCU,  
TSM3222UF42

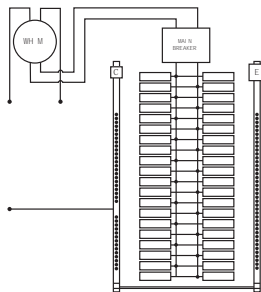

TSM4020UWCU

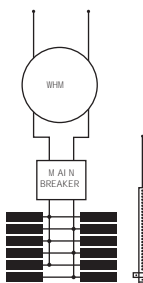

TSMR1212CSCU, TSMB1212CSCU

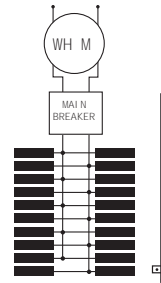

TSMR2020CSCU, TSMR2015CSCU,  
TSMB2020CSCU, TSMB2015CSCU

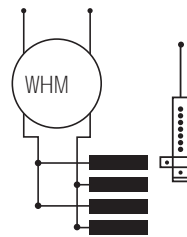

TSLR420CSCU, TSLR412CSCU,  
TSLB412CSCU, TSLB420CSCU





# Load Centers and Circuit Breakers

## PowerMark Gold and Plus Load Centers

### Circuit Breakers

# Section 1

### Wiring Diagrams

Breaker Symbol	Breaker Fill	
	1" THQL	1/2" THQP
	1	—
	1	2

Terminal Symbol	Wire Range (AWG/kcmil)	
	Cu	Al
o	14-8	12-8
•	14-4	12-4
A	6-2	6-2
B	14-1/0	12-1/0
C	6-2/0	6-2/0
D	1-300	2/0-300
E	1-300	1-300
F	6-1	6-1
G	6-3	6-3

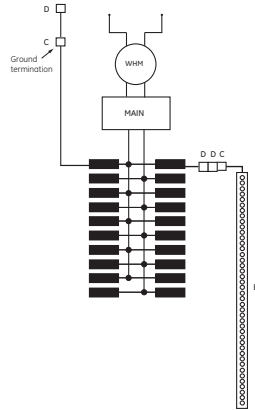

TSMR2020CSCUFMG

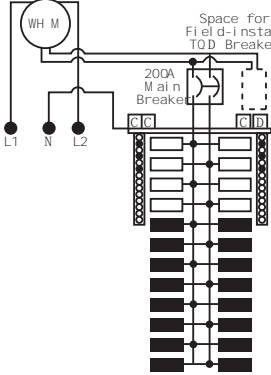

TM2440RMS, RMRS, RMS,  
TMH2440RMS, TMH2440RMRS

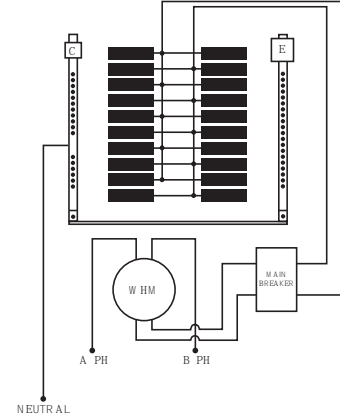

TSM2022USCU, TSM2022UFUCU

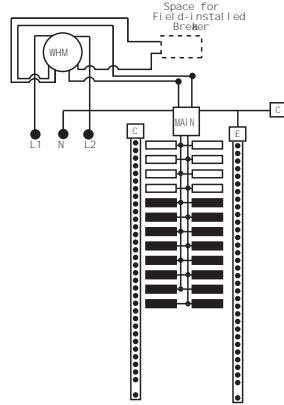

TSDA2432UC42, TSDA2440UC42

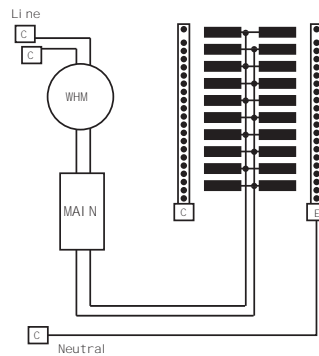

TSM2015URCU

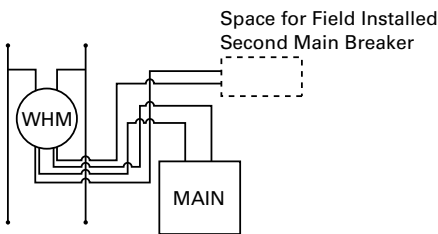

TSD032UFUCU

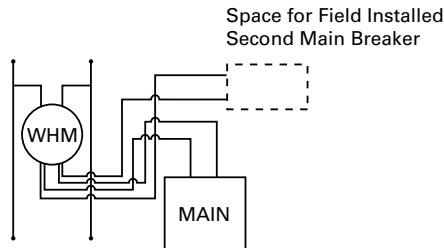

TSDR040UFUCU

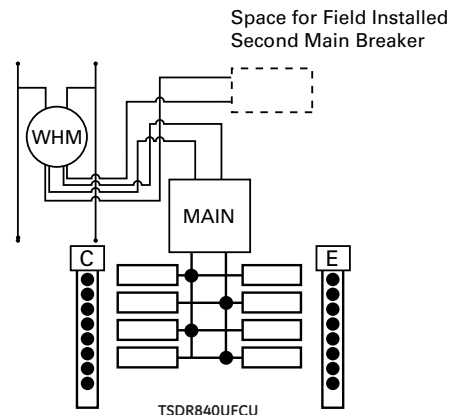

TSDR840UFUCU



# Load Centers and Circuit Breakers

## PowerMark Gold and Plus Load Centers

### Circuit Breakers

Indoor Enclosures

#### Knockouts

Symbol	A	•	B	C	D	E	F	G	H	J	K	L	M	N	P	Q	R	S	T	U	V	W	X	Y	Z		
Conduit Size in inches	5/16	-	-	-	-	-	-	-	-	-	-	-	-	-	-	-	-	-	-	-	-	-	-	-	-		
	-	3/8	-	3/8	-	-	3/8	-	-	-	-	-	-	-	-	-	-	-	-	-	-	-	-	-	-		
	-	1/2	1/2	1/2	1/2	-	1/2	1/2	1/2	-	-	-	-	-	-	-	-	-	-	-	-	-	-	-	1/2		
	-	-	-	3/4	3/4	3/4	3/4	3/4	3/4	3/4	3/4	3/4	-	-	3/4	-	-	-	-	3/4	-	-	3/4	-	3/4	3/4	
	-	-	-	-	-	-	1	1	1	1	1	1	1	-	1	1	-	-	1	-	-	1	-	1	1	1	
	-	-	-	-	-	-	-	-	-	-	-	-	-	-	-	-	-	-	1 1/4	1 1/4	-	-	-	1 1/4	1 1/4	-	
	-	-	-	-	-	-	-	-	-	-	-	1 1/2	1 1/2	1 1/2	1 1/2	-	1 1/2	1 1/2	1 1/2	-	-	-	1 1/2	1 1/2	1 1/2	1 1/2	
	-	-	-	-	-	-	-	-	-	-	-	-	-	-	-	2	2	2	2	2	-	2	2	-	2	2	2
	-	-	-	-	-	-	-	-	-	-	-	-	-	-	-	2 1/2	2 1/2	2 1/2	2 1/2	-	2 1/2	2 1/2	-	2 1/2	2 1/2	2 1/2	2 1/2
	-	-	-	-	-	-	-	-	-	-	-	-	-	-	-	-	-	-	3	-	3	3	-	-	-	-	
-	-	-	-	-	-	-	-	-	-	-	-	-	-	-	-	-	-	-	3 1/2	3 1/2	3 1/2	-	-	-	-		
-	-	-	-	-	-	-	-	-	-	-	-	-	-	-	-	-	-	-	-	4	-	-	-	-	-		

#### Dimensions (in inches)

Box No.	Width	Height	Depth
1A	5 11/16	10 1/4	3 3/8
2	7 1/2	9 7/32	3 5/16
2A	7 1/4	9	3
3A	11 9/16	11 3/8	3 3/8
4	14	19	3 3/4
4A	14	19	3 3/4
6	14	23	3 3/4
7	14	24 11/16	3 3/4
8	14	26 7/16	3 3/4
9	14	28 7/16	3 3/4
9A	14	28 7/16	3 3/4
11	14	33 3/16	3 3/4
12	14	35 7/16	3 3/4
13	14	39 3/16	3 3/4
14	14	43 7/16	3 3/4
15	14	43 7/16	4 5/8
16	16	45 1/8	5 13/16
17	20	59 7/8	6 3/32
18	14	16	3 3/8

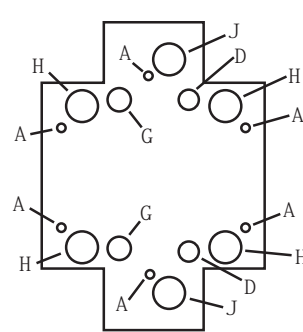

Box 1A

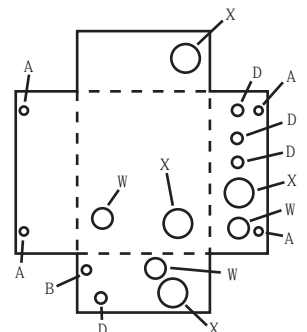

Box 2

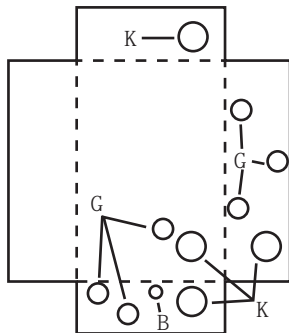

Box 2A

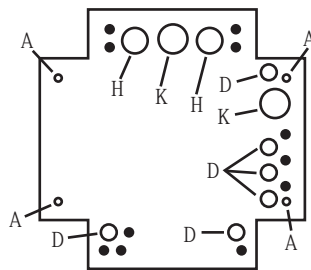

Box 3A

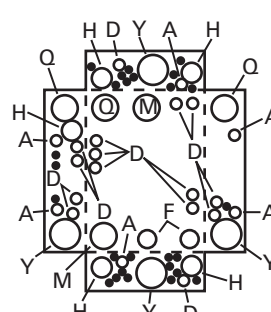

Box 4, 6, 7, 8, 9, 11, 12, 13, 14

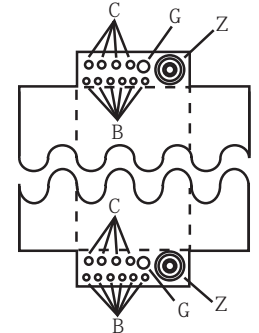

Box 4A, 9A

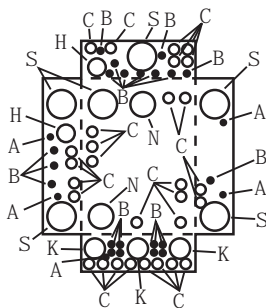

Box 15

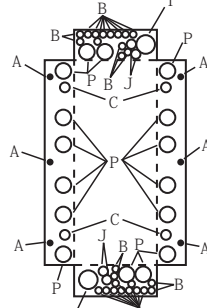

Box 16

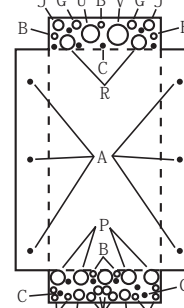

Box 17

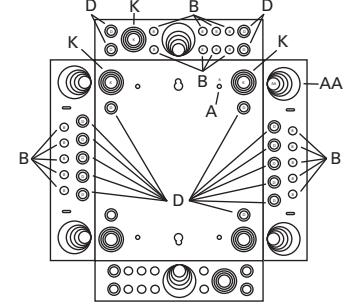

Box 18





# Load Centers and Circuit Breakers

## PowerMark Gold and Plus Load Centers

### Circuit Breakers

# Section 1

Outdoor Enclosures

### Knockouts

Symbol	A	•	B	C	D	E	F	G	H	J	K	L	M	N	P	Q	R	S	T	U	V	W	X	Y	Z	AA	BB	CC	DD	
Conduit Size in Inches	9/16	-	-	-	-	-	-	-	-	-	-	-	-	-	-	-	-	-	-	-	-	-	-	-	-	-	-	-	-	-
	3/8	-	-	3/8	-	-	-	-	-	-	-	-	-	-	-	-	-	-	-	-	-	-	-	-	-	-	-	-	-	-
	1/2	1/2	1/2	1/2	1/2	-	1/2	1/2	1/2	-	-	-	-	-	-	-	-	1/2	-	-	-	-	-	-	1/2	-	-	1/2	1/2	
	-	-	-	3/4	3/4	3/4	3/4	3/4	3/4	3/4	3/4	3/4	3/4	3/4	3/4	3/4	3/4	3/4	3/4	3/4	3/4	3/4	3/4	3/4	3/4	3/4	3/4	3/4	3/4	3/4
	-	-	-	-	-	1	1	1	1	1	1	1	1	1	1	1	1	1	1	1	1	1	1	1	1	1	1	1	1	1
	-	-	-	-	-	1 1/4	-	1 1/4	1 1/4	1 1/4	1 1/4	1 1/4	1 1/4	1 1/4	1 1/4	1 1/4	1 1/4	1 1/4	1 1/4	1 1/4	1 1/4	1 1/4	1 1/4	1 1/4	1 1/4	1 1/4	1 1/4	1 1/4	1 1/4	1 1/4
	-	-	-	-	-	1 1/2	-	-	-	-	1 1/2	1 1/2	1 1/2	1 1/2	1 1/2	1 1/2	1 1/2	1 1/2	1 1/2	1 1/2	1 1/2	1 1/2	1 1/2	1 1/2	1 1/2	1 1/2	1 1/2	1 1/2	1 1/2	
	-	-	-	-	-	-	-	-	-	-	-	2	2	2	2	2	2	2	2	2	2	2	2	2	2	2	2	2	2	2
	-	-	-	-	-	-	-	-	-	-	-	-	-	-	-	2 1/2	2 1/2	2 1/2	2 1/2	2 1/2	2 1/2	2 1/2	2 1/2	2 1/2	2 1/2	2 1/2	2 1/2	2 1/2	2 1/2	
	-	-	-	-	-	-	-	-	-	-	-	-	-	-	-	-	-	-	3	3	3	3	3	3	3	3	3	3	3	3
-	-	-	-	-	-	-	-	-	-	-	-	-	-	-	-	-	-	3 1/2	3 1/2	3 1/2	3 1/2	3 1/2	3 1/2	3 1/2	3 1/2	3 1/2	3 1/2	3 1/2		
-	-	-	-	-	-	-	-	-	-	-	-	-	-	-	-	-	-	-	4	4	4	4	4	4	4	4	4	4	4	

### Dimensions (in inches)

Box No.	Width	Height	Depth
R1	7 1/2	9 7/32	3 5/16
R1A	7 1/4	10	3 3/4
R1B	7 3/8	13	3 3/4
R2A	11 1/4	11 1/8	3 1/4
R3A	13	21 1/2	5
R3	12 1/2	21 3/16	4 5/8
R4A	14 11/16	30 3/16	5 1/4
R4	14	33 3/16	4 5/8
R5A	13	29	5
R5	12 1/2	28 11/16	4 5/8
R6A	13	33	5
R6	14	35 7/16	4 5/8
R7A	14 11/16	34 3/16	5 1/4
R7	14	39 3/16	4 5/8
R8A	14 21/32	43 1/4	6 13/32
R8	14	43 11/16	5 3/4
R9	16	45 15/16	5 27/32
R10	20	48 15/16	6 7/8
R11	20	59 15/16	6 7/8
R41	7 1/2	13 1/4	4

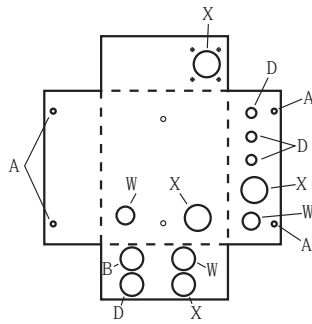

Box R1

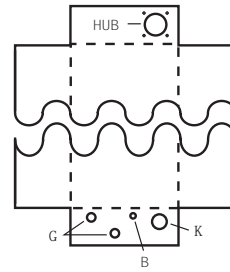

Box R1A

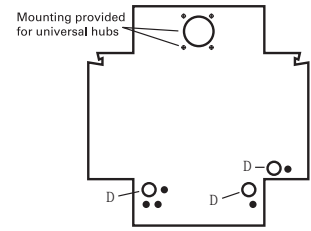

Box R2A

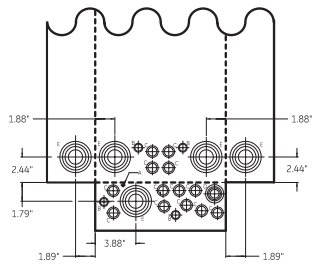

Box R3A, R5A, R6A

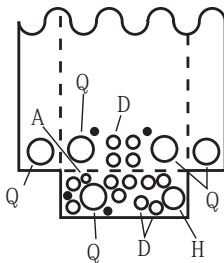

Box R3, R4, R5, R6, R7

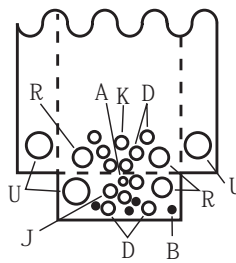

Box R8

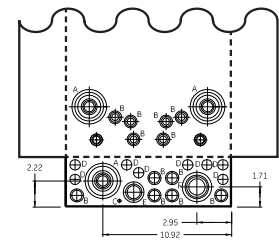

Box R4A, R7A

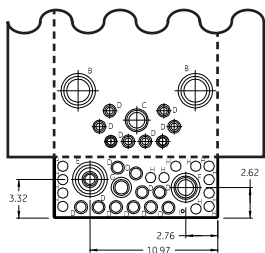

R8A

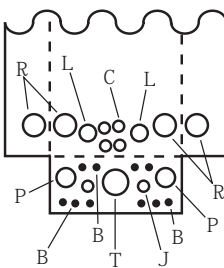

Box R9

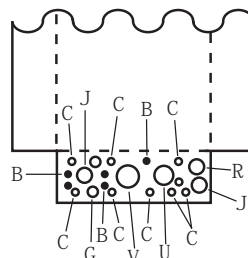

Box R10, R11

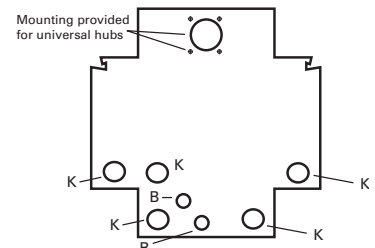

Box R41



# Load Centers and Circuit Breakers

## PowerMark Gold and Plus Load Centers

### Circuit Breakers

Meter Socket Load Centers

# Section 1

### Knockouts

Symbol	A	•	B	C	D	E	F	G	H	J	K	L	M	N	P	Q	R	S	T	U	V	W	X	Y	Z	AA	BB	CC	DD	EE	FF	
Conduit Size in inches	5/32	-	-	-	-	-	-	-	-	-	-	-	-	-	-	-	-	-	-	-	-	-	-	-	-	-	-	-	-	-	-	-
	-	3/8	-	3/8	-	-	3/8	-	-	-	-	-	-	-	-	-	-	-	-	-	-	-	-	-	-	-	-	-	-	-	-	-
	-	1/2	1/2	1/2	1/2	-	1/2	1/2	1/2	-	-	-	-	-	-	-	-	1/2	-	-	-	-	-	-	1/2	-	-	1/2	1/2	1/2	-	-
	-	-	-	3/4	3/4	3/4	3/4	3/4	3/4	3/4	3/4	3/4	-	-	3/4	-	3/4	-	3/4	-	-	-	3/4	-	3/4	-	3/4	3/4	-	3/4	-	-
	-	-	-	-	-	-	1	1	1	1	1	1	1	-	1	1	-	1	-	1	-	-	1	-	1	-	1	1	-	1	-	-
	-	-	-	-	-	-	1 1/4	-	1 1/4	1 1/4	1 1/4	1 1/4	1 1/4	1 1/4	1 1/4	1 1/4	-	1 1/4	1 1/4	-	1 1/4	1 1/4	-	1 1/4	1 1/4	1 1/4	-	1 1/4	1 1/4	-	1 1/4	1 1/4
	-	-	-	-	-	-	1 1/2	-	-	-	-	1 1/2	1 1/2	1 1/2	1 1/2	-	1 1/2	1 1/2	1 1/2	-	1 1/2	1 1/2	-	1 1/2	1 1/2	1 1/2	-	1 1/2	1 1/2	1 1/2	1 1/2	
	-	-	-	-	-	-	-	-	-	-	-	2	2	2	2	2	2	2	-	2	2	-	2	2	-	2	2	-	2	2	2	2
	-	-	-	-	-	-	-	-	-	-	-	-	-	-	-	2 1/2	2 1/2	2 1/2	2 1/2	-	2 1/2	2 1/2	-	2 1/2	-	2 1/2	-	-	2 1/2	2 1/2	2 1/2	
	-	-	-	-	-	-	-	-	-	-	-	-	-	-	-	-	-	-	-	-	3	3	-	-	-	-	3	-	-	-	-	-
-	-	-	-	-	-	-	-	-	-	-	-	-	-	-	-	-	-	-	-	3 1/2	3 1/2	3 1/2	-	-	-	3 1/2	-	-	-	-	-	
-	-	-	-	-	-	-	-	-	-	-	-	-	-	-	-	-	-	-	-	-	4	-	-	-	-	4	-	-	-	-	-	

### Dimensions (in inches)

Box No.	Width	Height	Depth
R12	14	23 1/2	4 7/8
R14	14	30 3/4	5 3/4
R15	16 3/4	33	6 3/16
R16	16 3/4	33	6 3/16
R17	16 3/4	34 1/4	7 5/16
R18	14 3/4	33	6 5/16
R19	16 3/4	28 1/2	7 5/16
R20	14 3/4	27 5/16	5 7/16
R21	14 9/16	43 5/8	7 3/16
R22	16 3/16	48 1/8	7 3/16
R23	30 1/4	40	6
R24	30 1/4	40	6

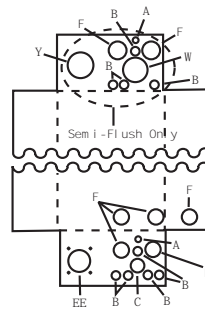

Box R12

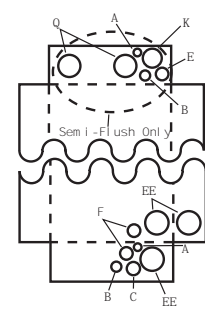

Box R14

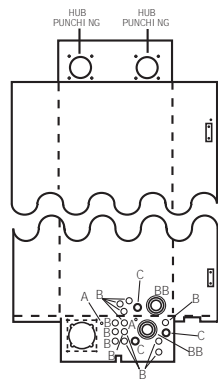

Box R16

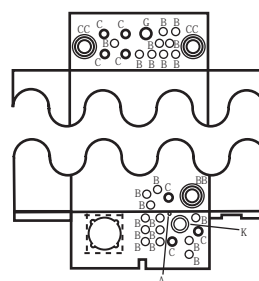

Box R17, R18

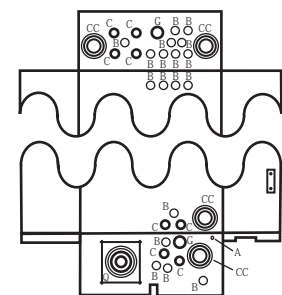

Box R19, R20

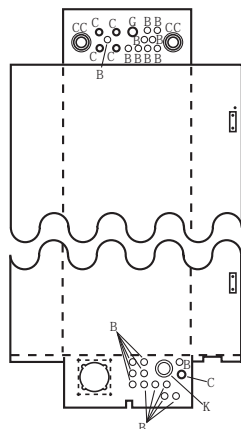

Box R21, R22

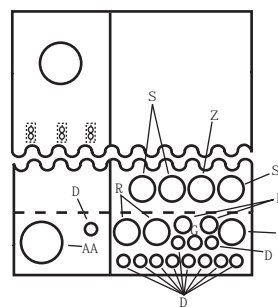

Box R23

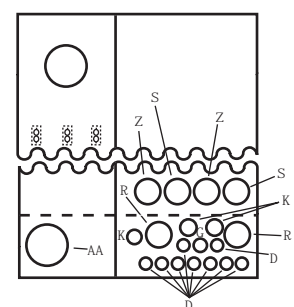

Box R24



# Load Centers and Circuit Breakers

## PowerMark Gold and Plus Load Centers

### Circuit Breakers

# Section 1

### Meter Socket Load Centers

### Knockouts

Symbol	A	*	B	C	D	E	F	G	H	J	K	L	M	N	P	Q	R	S	T	U	V	W	X	Y	Z	AA	BB	CC	DD	EE	FF	
Conduit Size in inches	5/32	-	-	-	-	-	-	-	-	-	-	-	-	-	-	-	-	-	-	-	-	-	-	-	-	-	-	-	-	-	-	
	-	3/8	-	3/8	-	3/8	-	3/8	-	3/8	-	3/8	-	3/8	-	3/8	-	3/8	-	3/8	-	3/8	-	3/8	-	3/8	-	3/8	-	3/8	-	3/8
	-	1/2	1/2	1/2	1/2	-	1/2	1/2	1/2	-	1/2	1/2	-	1/2	1/2	-	1/2	1/2	-	1/2	1/2	-	1/2	1/2	-	1/2	1/2	-	1/2	1/2	-	1/2
	-	-	3/4	3/4	3/4	3/4	3/4	3/4	3/4	3/4	3/4	3/4	3/4	3/4	3/4	3/4	3/4	3/4	3/4	3/4	3/4	3/4	3/4	3/4	3/4	3/4	3/4	3/4	3/4	3/4	3/4	3/4
	-	-	-	-	-	1	1	1	1	1	1	1	1	1	1	1	1	1	1	1	1	1	1	1	1	1	1	1	1	1	1	1
	-	-	-	-	-	1 1/4	-	1 1/4	1 1/4	1 1/4	1 1/4	1 1/4	1 1/4	1 1/4	1 1/4	1 1/4	1 1/4	1 1/4	1 1/4	1 1/4	1 1/4	1 1/4	1 1/4	1 1/4	1 1/4	1 1/4	1 1/4	1 1/4	1 1/4	1 1/4	1 1/4	
	-	-	-	-	-	1 1/2	-	1 1/2	1 1/2	1 1/2	1 1/2	1 1/2	1 1/2	1 1/2	1 1/2	1 1/2	1 1/2	1 1/2	1 1/2	1 1/2	1 1/2	1 1/2	1 1/2	1 1/2	1 1/2	1 1/2	1 1/2	1 1/2	1 1/2	1 1/2	1 1/2	
	-	-	-	-	-	-	-	-	-	-	-	-	-	-	-	2	2	2	2	2	2	2	2	2	2	2	2	2	2	2	2	2
	-	-	-	-	-	-	-	-	-	-	-	-	-	-	-	2 1/2	2 1/2	2 1/2	2 1/2	2 1/2	2 1/2	2 1/2	2 1/2	2 1/2	2 1/2	2 1/2	2 1/2	2 1/2	2 1/2	2 1/2	2 1/2	
	-	-	-	-	-	-	-	-	-	-	-	-	-	-	-	-	-	-	-	3	3	3	3	3	3	3	3	3	3	3	3	3
-	-	-	-	-	-	-	-	-	-	-	-	-	-	-	-	-	-	-	3 1/2	3 1/2	3 1/2	3 1/2	3 1/2	3 1/2	3 1/2	3 1/2	3 1/2	3 1/2	3 1/2	3 1/2	3 1/2	
-	-	-	-	-	-	-	-	-	-	-	-	-	-	-	-	-	-	-	-	4	4	4	4	4	4	4	4	4	4	4	4	

### Dimensions (in inches)

Box No.	Width	Height	Depth
R25	14	26	4 1/2
R26	14 9/16	43 5/8	6 3/16
R27	14 9/16	48 1/8	6 3/16
R28	22 1/2	27 7/8	6 1/4
R29	22 1/2	34 7/8	6 1/4
R30	14 9/16	40 1/2	6 3/16
R31	14 9/16	33 9/16	6 3/16
R32	16	17	5
R32A	18 7/8	18 9/16	5
R40	14	32	4 1/2

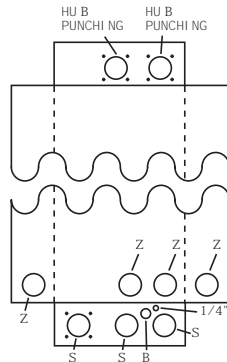

Box R25

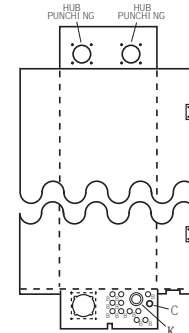

Box R26, R27

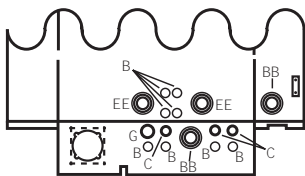

Box R28

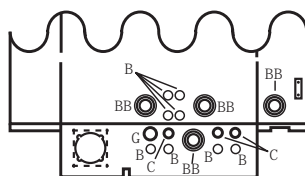

Box R29

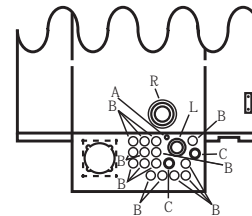

Box R30

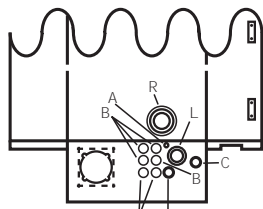

Box R31

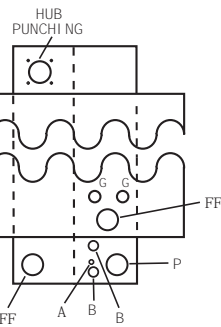

Box R32

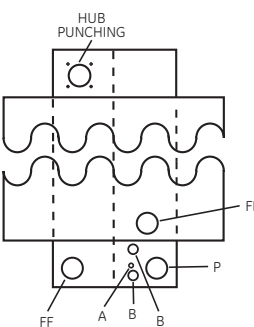

Box R32A

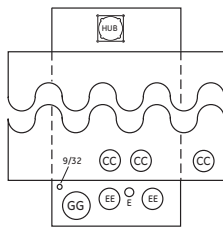

Box R40





