

For more information on these products, order publications from Section 27.

Quick Selection Guide, Enclosure Types	4-2
General Duty, Type TG	4-5
Heavy Duty, Type TH	4-7
Mill Duty, Type TH	4-14
Double Throw Switches, Type TC, TDT	4-17
Special Purpose, Heavy Duty, Type TH	4-20
Definite Purpose	4-22
AC Disconnects	4-23
Accessories: NEMA Type 1 and 3R Enclosures	4-24
Accessories: NEMA Type 4/4X and Mill Duty Enclosures	4-26
Additional Accessories	4-28
Enclosure and Knockout Dimensions	4-30 through 4-38

Notes:

General Duty Safety Switches incorporate a Cover Interlock (30–200 amps).

All General Duty, Heavy Duty, Mill Duty and Double Throw safety switches are certified for use in seismic zones. Refer to publication DET-789 for specific seismic ratings.



General Duty Safety Switch, Single-throw

Max. System Voltage	Ampere Rating	Switch Type	UL Listed Fusing		Enclosure Type	BuyLog Page
			Class	Withstanding Rating (rms Sym Amps)		
250Vac 250Vdc	30-200	Fusible	K	10,000	1 3R	4-5, 4-6
			H	10,000		
			R	100,000		
			K	10,000		
			H	10,000		
			R	10,000		
	400-600	No ¹ Fuse	K	10,000		
			H	10,000		
			R	10,000		
			K	10,000		
			H	10,000		
			R	10,000		



TG3321

Heavy Duty Safety Switch, Single-throw

Max. System Voltage	Ampere Rating	Switch Type	UL Listed Fusing		Enclosure Type	BuyLog Page
			Class	Withstanding Rating (rms Sym Amps)		
600Vac 250Vdc	30-1200	Fusible	H	10,000	1 3R 4/4X 5.12 Mill Duty	4-7 through 4-16
			R	200,000 ³		
			J	200,000 ³		
			L ²	100,000		
			H	10,000		
		No ¹ Fuse	R	10,000		
			J	10,000		
			L ²	10,000		



TH3361SS

Double-throw Safety Switch

Max. System Voltage	Ampere Rating	Switch Type	UL Listed Fusing		Enclosure Type	BuyLog Page
			Class	Withstanding Rating (rms Sym Amps)		
600Vac 250Vdc	30-600	No Fuse	—	10,000	1 3R	4-17 through 4-19

¹Non-fusible switch withstand ratings apply when protected by corresponding listed fuse type.

²Class L fuses are only applicable when used with 800 and 1200A Type TC safety switches.

³Unless otherwise noted.



TC10323R



Enclosure Types

Type 1—Enclosures constructed for indoor use to provide a degree of protection to personnel against incidental contact with the enclosed equipment and to provide a degree of protection against falling dirt.

Type 3R—Enclosures constructed for either indoor or outdoor use to provide a degree of protection to personnel against incidental contact with the enclosed equipment; to provide a degree of protection against falling dirt, rain, sleet, and snow; and that will be undamaged by the external formation of ice on the enclosure

Type 4—Enclosures constructed for either indoor or outdoor use to provide a degree of protection to personnel against incidental contact with the enclosed equipment; to provide a degree of protection against falling dirt, rain, sleet, snow, windblown dust, splashing water, and hose-directed water; and that will be undamaged by the external formation of ice on the enclosure.

Type 4X—Enclosures constructed for either indoor or outdoor use to provide a degree of protection to personnel against incidental contact with the enclosed equipment; to provide a degree of protection against falling dirt, rain, sleet, snow, windblown dust, splashing water, hose-directed water, and corrosion; and that will be undamaged by the external formation of ice on the enclosure.

Type 5—Enclosures constructed for indoor use to provide a degree of protection to personnel against incidental contact with the enclosed equipment; to provide a degree of protection against falling dirt; against settling airborne dust, lint, fibers, and flyings; and to provide a degree of protection against dripping and light splashing of liquids

Type 12—Enclosures constructed (without knockouts) for indoor use to provide a degree of protection to personnel against incidental contact with the enclosed equipment; to provide a degree of protection against falling dirt; against circulating dust, lint, fibers, and flyings; and to provide a degree of protection against dripping and light splashing of liquids

Application Note: For applications of disconnecting means in motor circuit applications, disconnect must be sized based on ampacity per NEC 430-110, but not less than 115% of Motor Name-Plate current.

Comparison of Specific Applications of Enclosures for Indoor Nonhazardous Locations

Provides a Degree of Protection Against the Following Environmental Conditions	Type of Enclosure				
	1*	4	4X	5	12
Incidental contact with the enclosed equipment	X	X	X	X	X
Falling dirt	X	X	X	X	X
Falling liquids and light splashing	-	X	X	X	X
Circulating dust, lint, fibers, and flyings**	-	X	X	-	X
Settling airborne dust, lint, fibers, and flyings**	-	X	X	X	X
Hosedown and splashing water	-	X	X	-	-
Oil and coolant seepage	-	-	-	-	X
Corrosive agents	-	-	X	-	-

*These enclosures may be ventilated.

** These fibers and flyings are nonhazardous materials and are not considered Class III type ignitable fibers or combustible flyings. For Class III type ignitable fibers or combustible flyings see the National Electrical Code, Article 500.

Applications of Enclosures for Outdoor Nonhazardous Locations

Provides a Degree of Protection Against the Following Environmental Conditions	Type of Enclosure		
	3R*	4	4X
Incidental contact with the enclosed equipment	X	X	X
Rain, snow, and sleet**	X	X	X
Windblown dust, lint, fibers, and flyings	-	X	X
Hosedown	-	X	X
Corrosive agents	-	-	X

* These enclosures may be ventilated.

** External operating mechanisms are not required to be operable when the enclosure is ice covered.



Safety Switches

Spec-Setter™ Safety Switches

Quick Selection Guide

Section 4

Product Number Structure

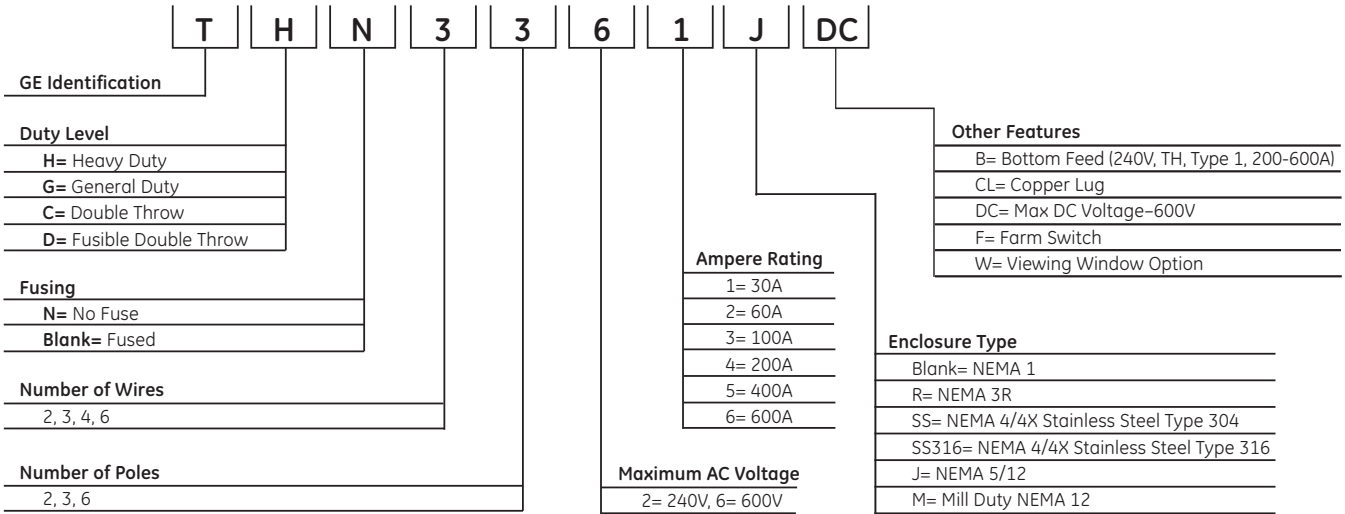

Note: This information is provided for interpreting product numbers. It should not be used to build product numbers.



Safety Switches General Duty, Type TG

Spec-Setter™ Safety Switches
30-600 Amperes
240 Volts AC
250 Volts DC

Cartridge Fuse, Type TG Switches

- Designed for residential or light commercial application where duty is not severe.
- UL Listed. Products in this section have been tested by UL and shown to meet the construction and performance requirements of UL Standard Number 98, Enclosed and Dead Front Switches.
- Meet or exceed NEMA Enclosed Switch Standard KS1 for Type GD.
- CSA Certified.
- Seismic Certified.
- 60°C and 75°C conductor rating.
- Cover Interlock (30-200 amps).
- Feature quick-make, quick-break mechanisms (30-200 amps).
- Suitable for use as service entrance equipment when installed in accordance with National Electrical Code.
- 30-200 amp fusible switches are rated 100,000 rms amps, sym IC when used with Class R fuses.
Order appropriate Class R Fusing Kit from pages 4-28 and 4-29.
- Bottom-feed version available for 200-600 amp, NEMA 1 only.

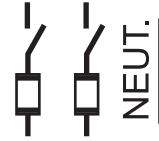

Fusible, Two-pole, 120/240 and 240 Volts AC; 250 Volts DC (30-100 amps only); Three-wire SN, 240 Volts AC

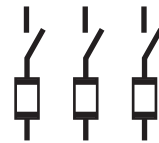

Fusible, Three-pole, 240 Volts AC

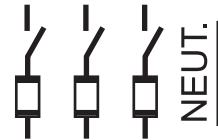

Fusible, Four-wire SN, 208/120 and 240 Volts AC



No Fuse, Two-pole, 240 Volts AC; 250 Volts DC (30-100 amps only); Three-pole, 240 Volts AC or Two-pole with Switching Neutral



Safety Switches General Duty, Type TG

Section 4

Spec-Setter™ Safety Switches

30-600 Amperes

240 Volts AC

250 Volts DC

Fusible, Two-pole, 120/240 and 240 Volts AC; 250 Volts DC (30-100 amps only); Three-wire SN, 240 Volts AC

Ampere Rating	Enclosure Type	HP, 240 Vac, NEC Std, 1-ph	HP, 240 Vac, NEC Std, 3-ph	HP, 240 Vac, Time Delay, 1-ph	HP, 240 Vac, Time Delay, 3-ph	HP, 125 Vdc	HP, 250 Vdc	Product Number
30A	NEMA Type 1	1 1/2	3	3	7 1/2	2	5	TG3221 ¹
60A	NEMA Type 1	3	7 1/2	10	15	3	10	TG3222
100A	NEMA Type 1	7 1/2	15	15	30	-	20	TG3223
200A	NEMA Type 1	15	25	15	50	-	-	TG3224
400A	NEMA Type 1	-	50	-	100	-	-	TG3225
600A	NEMA Type 1	-	75	-	100	-	-	TG3226
30A	NEMA Type 3R	1 1/2	3	3	7 1/2	2	5	TG3221R
60A	NEMA Type 3R	3	7 1/2	10	15	3	10	TG3222R
100A	NEMA Type 3R	7 1/2	15	15	30	-	20	TG3223R
200A	NEMA Type 3R	15	25	15	50	-	-	TG3224R
400A	NEMA Type 3R	-	50	-	100	-	-	TG3225R
600A	NEMA Type 3R	-	75	-	100	-	-	TG3226R

Fusible, Three-pole, 240 Volts AC; 250 Volts DC (30-100 amps only)

Ampere Rating	Enclosure Type	HP, 240 Vac, NEC Std, 1-ph	HP, 240 Vac, NEC Std, 3-ph	HP, 240 Vac, Time Delay, 1-ph	HP, 240 Vac, Time Delay, 3-ph	HP, 125 Vdc	HP, 250 Vdc	Product Number
30A	NEMA Type 1	1 1/2	3	3	7 1/2	-	5	TG4321 ¹
60A	NEMA Type 1	3	7 1/2	10	15	3	10	TG4322
100A	NEMA Type 1	7 1/2	15	15	30	-	20	TG4323
200A	NEMA Type 1	15	25	15	50	-	-	TG4324
400A	NEMA Type 1	-	50	-	100	-	-	TG3325
600A	NEMA Type 1	-	75	-	100	-	-	TG3326
30A	NEMA Type 3R	1 1/2	3	3	7 1/2	-	5	TG4321R
60A	NEMA Type 3R	3	7 1/2	10	15	3	10	TG4322R
100A	NEMA Type 3R	7 1/2	15	15	30	-	20	TG4323R
200A	NEMA Type 3R	15	25	15	50	-	-	TG4324R
400A	NEMA Type 3R	-	50	-	100	-	-	TG3325R
600A	NEMA Type 3R	-	75	-	100	-	-	TG3326R

Fusible, Four-wire SN, 208/120 and 240 Volts AC

Ampere Rating	Enclosure Type	HP, 240 Vac, NEC Std, 1-ph	HP, 240 Vac, NEC Std, 3-ph	HP, 240 Vac, Time Delay, 1-ph	HP, 240 Vac, Time Delay, 3-ph	HP, 125 Vdc	HP, 250 Vdc	Product Number
30A	NEMA Type 1	1 1/2	3	3	7 1/2	-	5	TG4321 ¹
60A	NEMA Type 1	3	7 1/2	10	15	3	10	TG4322
100A	NEMA Type 1	7 1/2	15	15	30	-	20	TG4323
200A	NEMA Type 1	15	25	15	50	-	-	TG4324
400A	NEMA Type 1	-	50	-	100	-	-	TG4325
600A	NEMA Type 1	-	75	-	100	-	-	TG4326
30A	NEMA Type 3R	1 1/2	3	3	7 1/2	-	5	TG4321R
60A	NEMA Type 3R	3	7 1/2	10	15	3	10	TG4322R
100A	NEMA Type 3R	7 1/2	15	15	30	-	20	TG4323R
200A	NEMA Type 3R	15	25	15	50	-	-	TG4324R
400A	NEMA Type 3R	-	50	-	100	-	-	TG3325R ²
600A	NEMA Type 3R	-	75	-	100	-	-	TN165 TG3326R ² TN166

No Fuse, Two-pole⁴, 240 Volts AC; 250 Volts DC (30-100 amps only); Three-pole, 240 Volts AC or Two-pole with Switching Neutral

Ampere Rating	Enclosure Type	HP, 240 Vac, NEC Std, 1-ph	HP, 240 Vac, NEC Std, 3-ph	HP, 240 Vac, Time Delay, 1-ph	HP, 240 Vac, Time Delay, 3-ph	HP, 125 Vdc	HP, 250 Vdc	Product Number
30A	NEMA Type 1	3	7 1/2	3	7 1/2	-	5	TGN3321 ¹
60A	NEMA Type 1	10	15	10	15	3	10	TGN3322 ³
100A	NEMA Type 1	15	30	15	30	-	20	TGN3323 ³
200A	NEMA Type 1	15	50	15	50	-	-	TGN3324
400A	NEMA Type 1	-	100	-	100	-	-	TGN3325
600A	NEMA Type 1	-	100	-	100	-	-	TGN3326
30A	NEMA Type 3R	3	7 1/2	3	7 1/2	-	5	TGN3321R
60A	NEMA Type 3R	10	15	10	15	3	10	TGN3322R ³
100A	NEMA Type 3R	15	30	15	30	-	20	TGN3323R ³
200A	NEMA Type 3R	15	50	15	50	-	-	TGN3324R

For Type 1 Enclosure: 200-600 amp devices available factory reversed for bottom feed. Add "B" suffix to product number (e.g., TG3224B). UL Listed.

For Type 3R Enclosure: 30-200 amp devices have removable closing cap. Order hubs for these devices separately on page 4-29. Larger amp devices require field cut openings and **customer-supplied** hub.

NEMA Type 3R No Fuse versions, 400-600 ampere rating, available in heavy duty, type TH models.

¹Packaged five per carton.

²For 4 wire applications order neutral kit separately. See page 4-24.

³Not suitable for use as service equipment. Solid neutral not available.

⁴Use three-pole switch for two-pole application.



Safety Switches Heavy Duty, Type TH

Spec-Setter™ Safety Switches

30-1200 Amperes

240 Volts AC

250 Volts DC

Section 4

Cartridge Fuse, Type TH Switches

- Designed for applications where safety, high performance and continuity of service are required.
- UL Listed. Products in this section have been tested by UL and shown to meet the construction and performance requirements of UL Standard Number 98, Enclosed and Dead Front Switches.
- CSA Certified.
- Seismic Certified.
- Meet Federal Specification WS-865C for heavy duty switches.
- Meet major automotive manufacturer's and JIC electrical specifications.
- Meet NEMA Enclosed Safety Switch Standard KS1 for Type HD.
- Full cover interlocks.
- 60°C and 75°C conductor ratings.
- Quick-make, quick-break mechanisms.
- Suitable for use as service entrance equipment when installed in accordance with the National Electrical Code.
- UL Listed ratings for fusible switches when used with these fuses:
 - Class H (10,000 rms amps, sym IC). Standard on 30-600 amps.
 - Class L (100,000 rms amps, sym IC). Only applicable when used with 800 and 1200 amp Type TC Safety Switches (e.g. TC72367)
 - Class J (200,000 rms amps, sym IC). See page 4-28 for field conversion details.
 - Class R (200,000 rms amps, sym IC). Order appropriate Class R fusing kit from page 4-28.
- Safety switch product numbers with suffix "SS" are grade 304 stainless steel. Product numbers with suffix "SS316" are grade 316 stainless steel.



Fusible, Two-pole,
240 Volts AC; 250 Volts DC
and Two-pole,
600 Volts DC, Fusible
(2 poles in series for 600 Vdc)

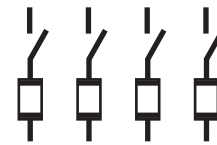

Four-pole, 480 and 600 Volts
AC, Fusible

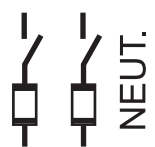

Fusible, Three-wire SN,
120/240 and 240 Volts AC

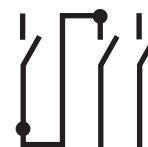

Two-pole, 600 Volts DC,
No Fuse



Fusible, Three-pole, 240 Volts
AC and Three-pole,
480, 480Y/277 and 600 Volts
AC-250 Volts DC, Fusible

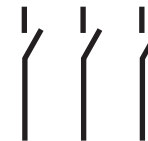

Three-pole, 480 and
600 Volts AC-250 Volts DC or
Two-pole with Switching
Neutral, No Fuse

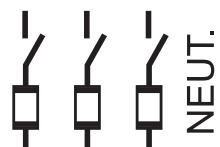

Fusible, Four-wire SN,
208/120 and 240 Volts AC



Four-pole, 480 and
600 Volts AC, No Fuse



Safety Switches Heavy Duty, Type TH

Spec-Setter™ Safety Switches

30-1200 Amperes

240 Volts AC

250 Volts DC

Section 4

Fusible, Two-pole, 240 Volts AC; 250 Volts DC

Ampere Rating	Enclosure Type	HP, 240 Vac, NEC Std, 1-ph	HP, 240 Vac, NEC Std, 3-ph	HP, 240 Vac, Time Delay, 1-ph	HP, 240 Vac, Time Delay, 3-ph	HP, 125 Vdc	HP, 250 Vdc	Product Number
30A	NEMA Type 1	1 1/2	3	3	7 1/2	-	5	TH3221
60A	NEMA Type 1	3	7 1/2	10	15	5	10	TH3222
100A	NEMA Type 1	7 1/2	15	15	30	-	20	TH3223
200A	NEMA Type 1	15	25	-	60	-	40	TH3224
400A	NEMA Type 1	-	50	-	125	-	50	TH3225
600A	NEMA Type 1	-	75	-	200	-	-	TH3226
800A	NEMA Type 1	-	-	-	-	-	-	TC72267 ^{1,2}
1200A	NEMA Type 1	-	-	-	-	-	-	TC72268 ¹
30A	NEMA Type 3R	1 1/2	3	3	7 1/2	-	5	TH3221R
60A	NEMA Type 3R	3	7 1/2	10	15	5	10	TH3222R
100A	NEMA Type 3R	7 1/2	15	15	30	-	20	TH3223R
200A	NEMA Type 3R	15	25	-	60	-	40	TH3224R
400A	NEMA Type 3R	-	50	-	125	-	50	TH3225R
600A	NEMA Type 3R	-	75	-	200	-	50	TH3226R
800A	NEMA Type 3R	-	-	-	-	-	-	TC72267R ^{1,2}
1200A	NEMA Type 3R	-	-	-	-	-	-	TC72268R ^{1,2}
30A	NEMA Type 4/4X	1 1/2	3	3	7 1/2	-	5	TH2221SS ⁴
60A	NEMA Type 4/4X	3	7 1/2	10	15	5	10	TH2222SS ⁴
100A	NEMA Type 4/4X	7 1/2	15	15	30	-	20	TH3223SS ⁴
200A	NEMA Type 4/4X	15	25	-	60	-	40	TH3224SS ⁴
400A	NEMA Type 4/4X	-	50	-	125	-	50	TH3225SS
600A	NEMA Type 4/4X	-	75	-	200	-	50	TH3226SS
30A	NEMA Type 5, 12	1 1/2	3	3	7 1/2	-	5	TH2221J
60A	NEMA Type 5, 12	3	7 1/2	10	15	5	10	TH2222J
100A	NEMA Type 5, 12	7 1/2	15	15	30	-	20	TH3223J
200A	NEMA Type 5, 12	15	25	-	60	-	40	TH3224J
400A	NEMA Type 5, 12	-	50	-	125	-	50	TH3225J
600A	NEMA Type 5, 12	-	75	-	200	-	50	TH3226J

Fusible, Three-wire SN, 120/240 and 240 Volts AC; 250 Volts DC (30-600 amps)

Ampere Rating	Enclosure Type	HP, 240 Vac, NEC Std, 1-ph	HP, 240 Vac, NEC Std, 3-ph	HP, 240 Vac, Time Delay, 1-ph	HP, 240 Vac, Time Delay, 3-ph	HP, 125 Vdc	HP, 250 Vdc	Product Number
30A	NEMA Type 1	1 1/2	3	3	7 1/2	-	5	TH3221
60A	NEMA Type 1	3	7 1/2	10	15	5	10	TH3222
100A	NEMA Type 1	7 1/2	15	15	30	-	20	TH3223
200A	NEMA Type 1	15	25	-	60	-	40	TH3224
400A	NEMA Type 1	-	50	-	125	-	50	TH3225
600A	NEMA Type 1	-	75	-	200	-	50	TH3226
800A	NEMA Type 1	-	-	-	-	-	-	TC72267 ^{1,3}
1200A	NEMA Type 1	-	-	-	-	-	-	TNI67
								TC72268 ^{1,3}
								TNI68A
30A	NEMA Type 3R	1 1/2	3	3	7 1/2	-	5	TH3221R
60A	NEMA Type 3R	3	7 1/2	10	15	5	10	TH3222R
100A	NEMA Type 3R	7 1/2	15	15	30	-	20	TH3223R
200A	NEMA Type 3R	15	25	-	60	-	40	TH3224R
400A	NEMA Type 3R	-	50	-	125	-	50	TH3225R
600A	NEMA Type 3R	-	75	-	200	-	50	TH3226R
800A	NEMA Type 3R	-	-	-	-	-	-	TC72267R ^{1,2,3}
								TNI67
								TC72268R ^{1,2,3}
								TNI68A
30A	NEMA Type 4/4X	1 1/2	3	3	7 1/2	-	5	TH3221SS ⁴
60A	NEMA Type 4/4X	3	7 1/2	10	15	5	10	TH3222SS ⁴
100A	NEMA Type 4/4X	7 1/2	15	15	30	-	20	TH3223SS ⁴
200A	NEMA Type 4/4X	15	25	-	60	-	40	TH3224SS ⁴
400A	NEMA Type 4/4X	-	50	-	125	-	50	TH3225SS
600A	NEMA Type 4/4X	-	75	-	200	-	50	TH3226SS
30A	NEMA Type 5, 12	1 1/2	3	3	7 1/2	-	5	TH3221J
60A	NEMA Type 5, 12	3	7 1/2	10	15	5	10	TH3222J
100A	NEMA Type 5, 12	7 1/2	15	15	30	-	20	TH3223J
200A	NEMA Type 5, 12	15	25	-	60	-	40	TH3224J
400A	NEMA Type 5, 12	-	50	-	125	-	50	TH3225J
600A	NEMA Type 5, 12	-	75	-	200	-	50	TH3226J

¹Rated 600 Vac only. Accepts Class L fuses only. Type TH electrical performance does not apply.

²Not CSA certified.

³Order switch and neutral separately.

⁴Available with "-BA" suffix for ARRA compliance. Same list price and GO schedule. Contact GE Sales Office for other ARRA compliant safety switches.



Safety Switches Heavy Duty, Type TH

Spec-Setter™ Safety Switches

30-1200 Amperes

240 Volts AC

250 Volts DC

Section 4

Fusible, Three-pole, 240 Volts AC; 250 Volts DC (30-600 amps)

Ampere Rating	Enclosure Type	HP, 240 Vac, NEC Std, 1-ph	HP, 240 Vac, NEC Std, 3-ph	HP, 240 Vac, Time Delay, 1-ph	HP, 240 Vac, Time Delay, 3-ph	HP, 125 Vdc	HP, 250 Vdc	Product Number
30A	NEMA Type 1	1 1/2	3	3	7 1/2	-	5	TH4321
60A	NEMA Type 1	3	7 1/2	10	15	5	10	TH4322
100A	NEMA Type 1	7 1/2	15	15	30	-	20	TH4323
200A	NEMA Type 1	15	25	-	60	-	40	TH4324
400A	NEMA Type 1	-	50	-	125	-	50	TH3325
600A	NEMA Type 1	-	75	-	200	-	50	TH3326
800A	NEMA Type 1	-	-	-	-	-	-	TC72367 ¹
1200A	NEMA Type 1	-	-	-	-	-	-	TC72368 ¹
30A	NEMA Type 3R	1 1/2	3	3	7 1/2	-	5	TH4321R
60A	NEMA Type 3R	3	7 1/2	10	15	5	10	TH4322R
100A	NEMA Type 3R	7 1/2	15	15	30	-	20	TH4323R
200A	NEMA Type 3R	15	25	-	60	-	40	TH4324R
400A	NEMA Type 3R	-	50	-	125	-	50	TH3325R
600A	NEMA Type 3R	-	75	-	200	-	50	TH3326R
800A	NEMA Type 3R	-	-	-	-	-	-	TC72367R ^{1,2}
1200A	NEMA Type 3R	-	-	-	-	-	-	TC72368R ^{1,2}
30A	NEMA Type 4/4X	1 1/2	3	3	7 1/2	-	5	TH3321SS ⁴
60A	NEMA Type 4/4X	3	7 1/2	10	15	5	10	TH3322SS ⁴
100A	NEMA Type 4/4X	7 1/2	15	15	30	-	20	TH4323SS ⁴
200A	NEMA Type 4/4X	15	25	-	60	-	40	TH4324SS ⁴
400A	NEMA Type 4/4X	-	50	-	125	-	50	TH4325SS
600A	NEMA Type 4/4X	-	75	-	200	-	50	TH4326SS
30A	NEMA Type 5, 12	1 1/2	3	3	7 1/2	-	5	TH3321J
60A	NEMA Type 5, 12	3	7 1/2	10	15	5	10	TH3322J
100A	NEMA Type 5, 12	7 1/2	15	15	30	-	20	TH4323J
200A	NEMA Type 5, 12	15	25	-	60	-	40	TH4324J
400A	NEMA Type 5, 12	-	50	-	125	-	50	TH4325J
600A	NEMA Type 5, 12	-	75	-	200	-	50	TH4326J

Fusible, Four-wire SN, 208/120 and 240 Volts AC; 250 Volts DC (30-600 amps)

Ampere Rating	Enclosure Type	HP, 240 Vac, NEC Std, 1-ph	HP, 240 Vac, NEC Std, 3-ph	HP, 240 Vac, Time Delay, 1-ph	HP, 240 Vac, Time Delay, 3-ph	HP, 125 Vdc	HP, 250 Vdc	Product Number
30A	NEMA Type 1	1 1/2	3	3	7 1/2	-	5	TH4321
60A	NEMA Type 1	3	7 1/2	10	15	5	10	TH4322
100A	NEMA Type 1	7 1/2	15	15	30	-	20	TH4323
200A	NEMA Type 1	15	25	-	60	-	40	TH4324
400A	NEMA Type 1	-	50	-	125	-	50	TH4325
600A	NEMA Type 1	-	75	-	200	-	50	TH4326
800A	NEMA Type 1	-	-	-	-	-	-	TC72367 ^{1,3}
1200A	NEMA Type 1	-	-	-	-	-	-	TNI67 TC72368 ^{1,3} TNI68A
30A	NEMA Type 3R	1 1/2	3	3	7 1/2	-	5	TH4321R
60A	NEMA Type 3R	3	7 1/2	10	15	5	10	TH4322R
100A	NEMA Type 3R	7 1/2	15	15	30	-	20	TH4323R
200A	NEMA Type 3R	15	25	-	60	-	40	TH4324R
400A	NEMA Type 3R	-	50	-	125	-	50	TH3325R ³
600A	NEMA Type 3R	-	75	-	200	-	50	TH3326R ³
800A	NEMA Type 3R	-	-	-	-	-	-	TC72367R ^{1,2,3} TNI67
1200A	NEMA Type 3R	-	-	-	-	-	-	TC72368R ^{1,2,3} TNI68A
30A	NEMA Type 4/4X	1 1/2	3	3	7 1/2	-	5	TH4321SS ⁴
60A	NEMA Type 4/4X	3	7 1/2	10	15	5	10	TH4322SS ⁴
100A	NEMA Type 4/4X	7 1/2	15	15	30	-	20	TH4323SS ⁴
200A	NEMA Type 4/4X	15	25	-	60	-	40	TH4324SS ⁴
400A	NEMA Type 4/4X	-	50	-	125	-	50	TH4325SS
600A	NEMA Type 4/4X	-	75	-	200	-	50	TH4326SS
30A	NEMA Type 5, 12	1 1/2	3	3	7 1/2	-	5	TH4321J
60A	NEMA Type 5, 12	3	7 1/2	10	15	5	10	TH4322J
100A	NEMA Type 5, 12	7 1/2	15	15	30	-	20	TH4323J
200A	NEMA Type 5, 12	15	25	-	60	-	40	TH4324J
400A	NEMA Type 5, 12	-	50	-	125	-	50	TH4325J
600A	NEMA Type 5, 12	-	75	-	200	-	50	TH4326J

240 Volts - No fuse or Four-pole, 240 Volts AC, Use 600-Volt switches on page 4-10 through 4-13.

For Type 1 Enclosure: 200-600 amp devices available factory reversed for bottom feed. Add "B" suffix to product number (e.g., TH3224B). UL Listed.

For Type 3R Enclosure: 30-200 amp devices have removable closing cap. Order hubs for these devices separately on page 4-29. Larger amp devices require field cut openings and **customer-supplied** hub.

¹Rated 600 Vac only. Accepts Class L fuses only. Type HD electrical performance does not apply.

²Not CSA certified.

³Order switch and neutral separately

⁴Available with "-BA" suffix for ARRA compliance. Same list price and GO schedule. Contact GE Sales Office for other ARRA compliant safety switches.



Safety Switches Heavy Duty, Type TH

Spec-Setter™ Safety Switches

30-1200 Amperes

240, 480, 600 Volts AC

600 Volts DC

Section 4

Two-pole 600 Volts DC, Fusible

Ampere Rating	Enclosure Type	HP, 480 Vac, NEC Std, 3-ph	HP, 600 Vac NEC Std, 3-ph	HP, 480 Vac Time Delay, 3-ph	HP, 600 Vac, Time Delay, 3-ph	HP, 125 Vdc	HP, 250 Vdc	HP, 600 Vdc	Product Number
30A	NEMA Type 1	-	-	-	-	-	-	15	TH2261DC
60A	NEMA Type 1	-	-	-	-	-	-	25	TH2262DC
100A	NEMA Type 1	-	-	-	-	-	-	25	TH2263DC
30A	NEMA Type 3R	-	-	-	-	-	-	15	TH2261RDC
60A	NEMA Type 3R	-	-	-	-	-	-	25	TH2262RDC
100A	NEMA Type 3R	-	-	-	-	-	-	25	TH2263RDC
30A	NEMA Type 4/4X	-	-	-	-	-	-	15	TH2261SSDC
60A	NEMA Type 4/4X	-	-	-	-	-	-	25	TH2262SSDC
100A	NEMA Type 4/4X	-	-	-	-	-	-	25	TH2263SSDC
30A	NEMA Type 5, 12	-	-	-	-	-	-	15	TH2261JDC
60A	NEMA Type 5, 12	-	-	-	-	-	-	25	TH2262JDC
100A	NEMA Type 5, 12	-	-	-	-	-	-	25	TH2263JDC

For Type 1 Enclosure: 200-600 amp devices available factory reversed for bottom feed. Add "B" suffix to product number (e.g., TH33365B). UL Listed.

For Type 3R Enclosure: 30-200 amp devices have removable closing cap. Order hubs for these devices separately on page 4-29. Larger amp devices require field cut openings and **customer-supplied** hub.



Safety Switches Heavy Duty, Type TH

Spec-Setter™ Safety Switches

30-1200 Amperes

240, 480, 600 Volts AC

600 Volts DC

Section 4



TH3361RF

Three-pole, 480, 480Y/277¹ and 600 Volts AC-250 DC, Fusible

Ampere Rating	Enclosure Type	HP, 480 Vac, NEC Std, 3-ph	HP, 600 Vac, NEC Std, 3-ph	HP, 480 Vac, Time Delay, 3-ph	HP, 600 Vac, Time Delay, 3-ph	HP, 125 Vdc	HP, 250 Vdc	HP, 600 Vdc	Product Number
30A	NEMA Type 1	5	7 1/2	15	20	-	5	-	TH3361
60A	NEMA Type 1	15	15	30	50	-	10	-	TH3362
100A	NEMA Type 1	25	30	60	75	-	20	-	TH3363
200A	NEMA Type 1	50	60	125	150	-	40	-	TH3364
400A	NEMA Type 1	100	125	250	350	-	50	-	TH3365
600A	NEMA Type 1	150	200	400	500	-	50	-	TH3366
800A	NEMA Type 1	-	-	-	-	-	-	-	TC72367 ²
1200A	NEMA Type 1	-	-	-	-	-	-	-	TC72368 ²
30A	NEMA Type 3R	5	7 1/2	15	20	-	5	-	TH3361R
30A	NEMA Type 3R	5	7 1/2	15	20	-	5	-	TH3361RF ⁴
60A	NEMA Type 3R	15	15	30	50	-	10	-	TH3361RF ^{2,4}
60A	NEMA Type 3R	15	15	30	50	-	10	-	TH3362R
60A	NEMA Type 3R	15	15	30	50	-	10	-	TH3362RF ⁴
100A	NEMA Type 3R	25	30	60	75	-	20	-	TH3363R
200A	NEMA Type 3R	50	60	125	150	-	40	-	TH3364R ⁶
400A	NEMA Type 3R	100	125	250	350	-	50	-	TH3365R
600A	NEMA Type 3R	150	200	400	500	-	50	-	TH3366R
800A	NEMA Type 3R	-	-	-	-	-	-	-	TC72367R ^{2,3}
1200A	NEMA Type 3R	-	-	-	-	-	-	-	TC72368R ^{2,3}
30A	NEMA Type 4/4X	5	7 1/2	15	20	-	5	-	TH3361SS ⁷
60A	NEMA Type 4/4X	15	15	30	50	-	10	-	TH3362SS ⁷
100A	NEMA Type 4/4X	25	30	60	75	-	20	-	TH3363SS ⁷
200A	NEMA Type 4/4X	50	60	125	150	-	40	-	TH3364SS ^{6,7}
400A	NEMA Type 4/4X	100	125	250	350	-	50	-	TH3365SS
600A	NEMA Type 4/4X	150	200	400	500	-	50	-	TH3366SS
30A	NEMA Type 5, 12	5	7 1/2	15	20	-	5	-	TH3361J
60A	NEMA Type 5, 12	15	15	30	50	-	10	-	TH3362J
100A	NEMA Type 5, 12	25	30	60	75	-	20	-	TH3363J
200A	NEMA Type 5, 12	50	60	125	150	-	40	-	TH3364J ⁶
400A	NEMA Type 5, 12	100	125	250	350	-	50	-	TH3365J
600A	NEMA Type 5, 12	150	200	400	500	-	50	-	TH3366J
30A	NEMA Type 3R, 5, 12	5	7 1/2	15	20	-	5	-	TH3361JR
60A	NEMA Type 3R, 5, 12	15	15	30	50	-	10	-	TH3362JR
100A	NEMA Type 3R, 5, 12	25	30	60	75	-	20	-	TH3363JR
200A	NEMA Type 3R, 5, 12	50	60	125	150	-	40	-	TH3364JR ⁶
400A	NEMA Type 3R, 5, 12	100	125	250	350	-	50	-	TH3365JR ⁸
600A	NEMA Type 3R, 5, 12	150	200	400	500	-	50	-	TH3366JR ⁸

Four-pole, 480 and 600 Volts AC, Fusible⁵

Ampere Rating	Enclosure Type	HP, 480 Vac, NEC Std, 2-ph	HP, 600 Vac, NEC Std, 2-ph	HP, 480 Vac, Time Delay, 2-ph	HP, 600 Vac, Time Delay, 2-ph	HP, 125 Vdc	HP, 250 Vdc	HP, 600 Vdc	Product Number
30A	NEMA Type 1, 3R, 5, 12	7 1/2	10	20	25	-	5	-	TH6661
60A	NEMA Type 1, 3R, 5, 12	15	20	40	50	-	10	-	TH6662
100A	NEMA Type 1, 3R, 5, 12	20	30	50	50	-	20	-	TH6663
200A	NEMA Type 1, 3R, 5, 12	50	50	-	-	-	40	-	TH6664

For Type 1 Enclosure: 200-600 amp devices available factory reversed for bottom feed. Add "B" suffix to product number (e.g., TH33365B). UL Listed.

For Type 3R Enclosure: 30-200 amp devices have removable closing cap. Order hubs for these devices separately on page 4-29. Larger amp devices require field cut openings and **customer-supplied** hub.

¹Order neutral kits from pages 4-24 and 4-26.

²Rated 600 Vac only. Accepts Class L fuses only. Type HD electrical performance does not apply.

³Not CSA Certified

⁴Farm switch with oversize Type 3R enclosure and vertical hinge. See enclosure dimensions on page 4-31.

⁵Use four poles of six-pole

⁶Rated to maximum 100,000 ampere interrupting capacity.

⁷Available with "-BA" suffix for ARRA compliance. Same list price and GO schedule. Contact GE Sales Office for other ARRA compliant safety switches.

⁸Not UL Listed.



Safety Switches Heavy Duty, Type TH

Spec-Setter™ Safety Switches

30-1200 Amperes

240, 480, 600 Volts AC

600 Volts DC

Section 4

Two-pole, 600 Volts DC, No Fuse

Ampere Rating	Enclosure Type	HP, 240 Vac, NEC Std, 1-ph	HP, 240 Vac, NEC Std, 3-ph	HP, 480 Vac, Time Delay, 3-ph	HP, 600 Vac, Time Delay, 3-ph	HP, 125 Vdc	HP, 250 Vdc	HP, 600 Vdc	Product Number
30A	NEMA Type 1	-	-	-	-	-	-	15	THN2261DC
60A	NEMA Type 1	-	-	-	-	-	-	25	THN2262DC
100A	NEMA Type 1	-	-	-	-	-	-	25	THN2263DC
30A	NEMA Type 3R	-	-	-	-	-	-	15	THN2261RDC
60A	NEMA Type 3R	-	-	-	-	-	-	25	THN2262RDC
100A	NEMA Type 3R	-	-	-	-	-	-	25	THN2263RDC
30A	NEMA Type 4/4X	-	-	-	-	-	-	15	THN2261SSDC
60A	NEMA Type 4/4X	-	-	-	-	-	-	25	THN2262SSDC
100A	NEMA Type 4/4X	-	-	-	-	-	-	25	THN2263SSDC
30A	NEMA Type 5, 12	-	-	-	-	-	-	15	THN2261JDC
60A	NEMA Type 5, 12	-	-	-	-	-	-	25	THN2262JDC
100A	NEMA Type 5, 12	-	-	-	-	-	-	25	THN2263JDC

Three-pole, 480 and 600 Volts AC - 250 Volts DC or Two-pole with Switching Neutral, No Fuse

Ampere Rating	Enclosure Type	HP, 240 Vac, NEC Std, 1-ph	HP, 240 Vac, NEC Std, 3-ph	HP, 480 Vac, Time Delay, 3-ph	HP, 600 Vac, Time Delay, 3-ph	HP, 125 Vdc	HP, 250 Vdc	HP, 600 Vdc	Product Number
30A	NEMA Type 1	3	10	-	-	3	5	-	THN3321 ¹
30A	NEMA Type 1	3	10	20	30	3	5	-	THN3361
60A	NEMA Type 1	10	20	50	60	5	10	-	THN3362
100A	NEMA Type 1	20	40	75	100	-	20	-	THN3363
200A	NEMA Type 1	30	60	125	150	-	40	-	THN3364
400A	NEMA Type 1	-	125	250	350	-	50	-	THN3365
600A	NEMA Type 1	-	200	400	500	-	50	-	THN3366
800A	NEMA Type 1	-	-	-	-	-	-	-	TC36367 ^{2,3}
1200A	NEMA Type 1	-	-	-	-	-	-	-	TC36368 ^{2,3}
30A	NEMA Type 3R	3	10	20	30	3	5	-	THN3361R
30A	NEMA Type 3R	3	10	20	30	3	5	-	THN3361RF ⁴
60A	NEMA Type 3R	10	20	50	60	5	10	-	THN3362R
60A	NEMA Type 3R	10	20	50	60	5	10	-	THN3362RF ⁴
100A	NEMA Type 3R	20	40	75	100	-	20	-	THN3363R
200A	NEMA Type 3R	30	60	125	150	-	40	-	THN3364R
400A	NEMA Type 3R	-	125	250	350	-	50	-	THN3365R
600A	NEMA Type 3R	-	200	400	500	-	50	-	THN3366R
30A	NEMA Type 4/4X	3	10	20	30	3	5	-	THN3361SS ⁵
60A	NEMA Type 4/4X	10	20	50	60	5	10	-	THN3362SS ⁵
100A	NEMA Type 4/4X	20	40	75	100	-	20	-	THN3363SS ⁵
200A	NEMA Type 4/4X	30	60	125	150	-	40	-	THN3364SS ⁵
400A	NEMA Type 4/4X	-	125	250	350	-	50	-	THN3365SS
600A	NEMA Type 4/4X	-	200	400	500	-	50	-	THN3366SS
30A	NEMA Type 5, 12	3	10	20	30	3	5	-	THN3361J
60A	NEMA Type 5, 12	10	20	50	60	5	10	-	THN3362J
100A	NEMA Type 5, 12	20	40	75	100	-	20	-	THN3363J
200A	NEMA Type 5, 12	30	60	125	150	-	40	-	THN3364J
400A	NEMA Type 5, 12	-	125	250	350	-	50	-	THN3365J
600A	NEMA Type 5, 12	-	200	400	500	-	50	-	THN3366J

For Type 1 Enclosure: 200-600 amp devices available factory reversed for bottom feed. Add "B" suffix to product number (e.g., TH33365B). UL Listed.

For Type 3R Enclosure: 30-200 amp devices have removable closing cap. Order hubs for these devices separately on page 4-29. Larger amp devices require field cut openings and **customer-supplied** hub.

¹Rated 250 Vac/dc only. Compact enclosure.

²Rated 600 Vac only. Type HD electrical performance does not apply.

³Neutral kit not available. Not suitable for use as service equipment. Order TC72XXX series product numbers and separate neutral kit as required.

⁴Farm switch with oversize Type 3R enclosure and vertical hinge. See enclosure dimensions on page 4-31.

⁵Available with "-BA" suffix for ARRA compliance. Same list price and GO schedule. Contact GE Sales Office for other ARRA compliant safety switches.



Safety Switches Heavy Duty, Type TH

Spec-Setter™ Safety Switches

30-1200 Amperes

240, 480, 600 Volts AC

600 Volts DC

Section 4

Four-pole, 480 and 600 Volts AC, No Fuse^{2,3}

Ampere Rating	Enclosure Type	HP, 240 Vac, NEC Std, 1-ph	HP, 240 Vac, NEC Std, 2-ph	HP, 480 Vac, Time Delay, 2-ph	HP, 600 Vac, Time Delay, 2-ph	HP, 125 Vdc	HP, 250 Vdc	HP, 600 Vdc	Product Number
30A	NEMA Type 1, 3R, 5, 12	-	10	20	25	-	5	-	THN6661
60A	NEMA Type 1, 3R, 5, 12	-	20	40	50	-	10	-	THN6662
100A	NEMA Type 1, 3R, 5, 12	-	30	50	50	-	20	-	THN6663
200A	NEMA Type 1, 3R, 5, 12	-	50	-	-	-	40	-	THN6664

Heavy Duty Safety Switches with 316 Stainless Steel Type NEMA 4/4X, Water and Dust-tight

- More resistant to general corrosion and pitting/crevice corrosion than 304 stainless steel
- Higher creep, stress-to-rupture and tensile strength at elevated temperatures than 304 stainless steel
- Excellent resistance to reducing acids and similar media
- Standard lead time 2 weeks

Three-pole 240/600 Volts—Fusible, 316 Stainless Steel

Ampere Rating	Enclosure Type	System Voltage	Product Number
30A	NEMA Type 4/4X	600Vac	TH3361SS316 ⁴
60A	NEMA Type 4/4X	600Vac	TH3362SS316 ⁴
100A	NEMA Type 4/4X	600Vac	TH3363SS316 ⁴
200A	NEMA Type 4/4X	600Vac	TH3364SS316 ^{4,5}
400A	NEMA Type 4/4X	600Vac	TH3365SS316
600A	NEMA Type 4/4X	600Vac	TH3366SS316

Three-pole 600 Volts—Non-Fusible, 316 Stainless Steel

Ampere Rating	Enclosure Type	System Voltage	Product Number
30A	NEMA Type 4/4X	600Vac	THN3361SS316 ⁴
60A	NEMA Type 4/4X	600Vac	THN3362SS316 ⁴
100A	NEMA Type 4/4X	600Vac	THN3363SS316 ⁴
200A	NEMA Type 4/4X	600Vac	THN3364SS316 ⁴
400A	NEMA Type 4/4X	600Vac	THN3365SS316
600A	NEMA Type 4/4X	600Vac	THN3366SS316

Viewing Window Option—Factory Installed Only

UL Listed Installation-Safety Switch Rating NEMA Type 4/4X, 5, 12 Standard Lead Time-3 Weeks

Factory Installed Product Number	Suffix for Water and Dust Tight NEMA Type 4/4X	Suffix for Drip and Dust Tight NEMA Type 5, 12
TH2221	SSW	JW
TH2222	SSW	JW
TH3221	SSW	JW
TH3222	-	JW
TH3223	SSW	JW
TH3224	SSW	JW
TH3321	-	JW
TH3322	SSW	JW
TH3361	SSW	JW
TH3362	SSW	JW
TH3363	SSW	JW
TH3364	SSW ⁵	JW ⁵
TH4321	SSW	JW
TH4322	SSW	JW
TH4323	SSW	JW
TH4324	SSW	JW
THN3361	SSW	JW
THN3362	SSW	JW
THN3363	SSW	JW
THN3364	SSW	JW

¹2-pole device

²Not CSA Certified

³Use four poles of six-pole switch. Reference page 4-20 for additional information.

⁴Available with "-BA" suffix for ARRA compliance. Same list price and GO schedule. Contact GE Sales Office for other ARRA compliant safety switches.

⁵Rated to maximum 100,000 amperes interrupting capacity.



Safety Switches Mill Duty, Type TH

Spec-Setter™ Safety Switches
30-600 Amperes
240, 480, 600 Volts AC
250, 600 Volts DC

Section 4

Cartridge Fuse, Type TH Switches

- Designed for mill, foundry and industrial applications where safety, high performance and continuity of service are required.
- UL Listed. Products in this section have been tested by UL and shown to meet the construction and performance requirements of UL Standard Number 98, Enclosed and Dead Front Switches.
- Meet Federal Specification WS-865C for heavy duty switches.
- Meet major automotive manufacturer's and JIC electrical specifications.
- Meet NEMA Enclosed Safety Switch Standard KS1 for Type HD.
- Full cover interlocks.
- Seismic Certified.
- 60°C and 75°C conductor ratings.
- Quick-make, quick-break mechanisms.
- Suitable for use as service entrance equipment when installed in accordance with the National Electrical Code.
- UL Listed ratings for fusible switches when used with these fuses:
 - Class H (10,000 rms amps, sym IC). Standard on 30-600 amp.
 - Class J (200,000 rms amp, sym IC). See page 4-28 for field conversion details.
 - Class R (200,000 rms amp, sym IC). Order appropriate Class R fusing kit from page 4-28.
- Safety switch product numbers with suffix "SS" are grade 304 stainless steel.

Type TH Interrupting and Withstandability Ratings

Ampere Rating	Interrupting Rating Amps ¹		Fuse Clearing ² (I ² t x 10 ³)
	Symmetrical 600 volts AC, 3-phase		
30A	360		50
60A	1200		200
100A	1200		500
200A	3,400		2,000
400A	10,000		6,000
600A	10,000		12,000

¹Maximum current at rated voltage that switch will interrupt three times without assistance from an external device.

²Peak let-through energy for withstandability and circuit closing tests.



Two-pole, 240 Volts AC - 250 Volts DC, Fusible

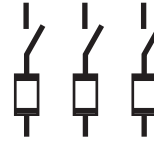

Three-pole, 240 Volts AC, Fusible



Fusible, Two-pole, 240 Volts AC; 250 Volts DC and Two-pole, 600 Volts DC, Fusible (2 poles in series for 600 Vdc)

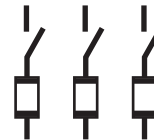

Three-pole, 480 and 600 Volts AC - 250 Volts DC Fusible

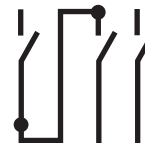

Two-pole, 600 Volts DC, No Fuse

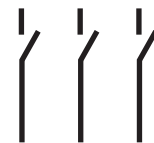

Three-pole, 480 and 600 Volts AC - 250 Volts DC, No Fuse



Safety Switches Mill Duty, Type TH

Spec-Setter™ Safety Switches

300-600 Amperes

240, 480, 600 Volts AC

250, 600 Volts DC

Section 4

Two-pole, 240 Volts AC - 250 Volts DC, Fusible

Ampere Rating	Enclosure Type ¹	HP, 240 Vac, NEC Std, 1-ph	HP, 240 Vac, NEC Std, 3-ph	HP, 240 Vac, Time Delay, 1-ph	HP, 240 Vac, Time Delay, 3-ph	HP, 125 Vdc	HP, 250 Vdc	HP, 600 Vdc	Product Number
30A	NEMA Type 12	1 1/2	-	3	-	-	5	-	TH2221M
60A	NEMA Type 12	3	-	10	-	5	10	-	TH2222M
100A	NEMA Type 12	7 1/2	-	15	-	-	20	-	TH2223M
200A	NEMA Type 12	15	-	-	-	-	40	-	TH2224M
30A	NEMA Type 4/4X	1 1/2	-	3	-	-	5	-	TH2221MSS
60A	NEMA Type 4/4X	3	-	10	-	5	10	-	TH2222MSS
100A	NEMA Type 4/4X	7 1/2	-	15	-	-	20	-	TH2223MSS
200A	NEMA Type 4/4X	15	-	-	-	-	40	-	TH2224MSS

Three-pole, 240 Volts AC, Fusible

Ampere Rating	Enclosure Type ¹	HP, 240 Vac, NEC Std, 1-ph	HP, 240 Vac, NEC Std, 3-ph	HP, 240 Vac, Time Delay, 1-ph	HP, 240 Vac, Time Delay, 3-ph	HP, 125 Vdc	HP, 250 Vdc	HP, 600 Vdc	Product Number
30A	NEMA Type 12	1 1/2	3	3	7 1/2	-	5	-	TH3321M
60A	NEMA Type 12	3	7 1/2	10	15	5	10	-	TH3322M ²
100A	NEMA Type 12	7 1/2	15	15	30	-	20	-	TH3323M
200A	NEMA Type 12	15	25	-	60	-	40	-	TH3324M
400A	NEMA Type 12	-	50	-	125	-	50	-	TH3325M
600A	NEMA Type 12	-	75	-	200	-	50	-	TH3326M
30A	NEMA Type 4/4X	1 1/2	3	3	7 1/2	-	5	-	TH3321MSS
60A	NEMA Type 4/4X	3	7 1/2	10	15	5	10	-	TH3322MSS
100A	NEMA Type 4/4X	7 1/2	15	15	30	-	20	-	TH3323MSS
200A	NEMA Type 4/4X	15	25	-	60	-	40	-	TH3324MSS
400A	NEMA Type 4/4X	-	50	-	125	-	50	-	TH3325MSS
600A	NEMA Type 4/4X	-	75	-	200	-	50	-	TH3326MSS

240 Volts-No Fuse use 600 Volt switches

Two-pole, 600 Volts DC, Fusible

Ampere Rating	Enclosure Type ¹	HP, 480 Vac, NEC Std, 3-ph	HP, 600 Vac, NEC Std, 3-ph	HP, 480 Vac, Time Delay, 3-ph	HP, 600 Vac, Time Delay, 3-ph	HP, 125 Vdc	HP, 250 Vdc	HP, 600 Vdc	Product Number
30A	NEMA Type 12	-	-	-	-	-	-	15	TH2261MDC
60A	NEMA Type 12	-	-	-	-	-	-	25	TH2262MDC
100A	NEMA Type 12	-	-	-	-	-	-	25	TH2263MDC

Three-pole, 480 and 600 Volts AC - 250 Volts DC, Fusible

Ampere Rating	Enclosure Type ¹	HP, 480 Vac, NEC Std, 3-ph	HP, 600 Vac, NEC Std, 3-ph	HP, 480 Vac, Time Delay, 3-ph	HP, 600 Vac, Time Delay, 3-ph	HP, 125 Vdc	HP, 250 Vdc	HP, 600 Vdc	Product Number
30A	NEMA Type 12	5	7 1/2	15	20	-	5	-	TH3361M ²
60A	NEMA Type 12	15	15	30	50	5	10	-	TH3362M
100A	NEMA Type 12	25	30	60	75	-	20	-	TH3363M
200A	NEMA Type 12	50	60	125	150	-	40	-	TH3364M ³
400A	NEMA Type 12	100	125	250	350	-	50	-	TH3365M
600A	NEMA Type 12	150	200	400	500	-	50	-	TH3366M
30A	NEMA Type 4/4X	5	7 1/2	15	20	-	5	-	TH3361MSS
60A	NEMA Type 4/4X	15	15	30	50	5	10	-	TH3362MSS ²
100A	NEMA Type 4/4X	25	30	60	75	-	20	-	TH3363MSS
200A	NEMA Type 4/4X	50	60	125	150	-	40	-	TH3364MSS ³
400A	NEMA Type 4/4X	100	125	250	350	-	50	-	TH3365MSS
600A	NEMA Type 4/4X	150	200	400	500	-	50	-	TH3366MSS

¹All mill duty switches accept neutral and auxiliary contact kits. Order from page 4-25.

²Available with viewing window - add "W" suffix. Consult Customer Service for price and availability.

³Rated to maximum 100,000 amperes interrupting capacity.



Safety Switches Mill Duty, Type TH

Spec-Setter™ Safety Switches

300-600 Amperes

240, 480, 600 Volts AC

250, 600 Volts DC

Section 4

Three-pole, 480 and 600 Volts AC – 250 Volts DC Fusible With Viewing Window

Ampere Rating	Enclosure Type ¹	HP, 240 Vac, NEC Std, 1-ph	HP, 240 Vac, NEC Std, 3-ph	HP, 480 Vac, Time Delay, 3-ph	HP, 600 Vac, Time Delay, 3-ph	HP, 125 Vdc	HP, 250 Vdc	HP, 600 Vdc	Product Number
30	NEMA Type 12	5	7 1/2	15	20	-	5	-	THN3361MW

Two-pole, 600 Volts DC, No Fuse

Ampere Rating	Enclosure Type ¹	HP, 240 Vac, NEC Std, 1-ph	HP, 240 Vac, NEC Std, 3-ph	HP, 480 Vac, Time Delay, 3-ph	HP, 600 Vac, Time Delay, 3-ph	HP, 125 Vdc	HP, 250 Vdc	HP, 600 Vdc	Product Number
30A	NEMA Type 12	-	-	-	-	-	-	15	THN2261MDC
60A	NEMA Type 12	-	-	-	-	-	-	25	THN2262MDC
100A	NEMA Type 12	-	-	-	-	-	-	25	THN2263MDC

Three-pole, 480 and 600 Volts AC - 250 Volts DC, No Fuse

Ampere Rating	Enclosure Type ¹	HP, 240 Vac, NEC Std, 1-ph	HP, 240 Vac, NEC Std, 3-ph	HP, 480 Vac, Time Delay, 3-ph	HP, 600 Vac, Time Delay, 3-ph	HP, 125 Vdc	HP, 250 Vdc	HP, 600 Vdc	Product Number
30A	NEMA Type 12	3	10	20	30	3	5	-	THN3361M
60A	NEMA Type 12	10	20	50	60	5	10	-	THN3362M ²
100A	NEMA Type 12	20	40	75	100	-	20	-	THN3363M
200A	NEMA Type 12	30	60	125	150	-	40	-	THN3364M
400A	NEMA Type 12	-	125	250	350	-	50	-	THN3365M
600A	NEMA Type 12	-	200	400	500	-	50	-	THN3366M
30A	NEMA Type 4/4X	3	10	20	30	3	5	-	THN3361MSS ²
60A	NEMA Type 4/4X	10	20	50	60	5	10	-	THN3362MSS
100A	NEMA Type 4/4X	20	40	75	100	-	20	-	THN3363MSS
200A	NEMA Type 4/4X	30	60	125	150	-	40	-	THN3364MSS
400A	NEMA Type 4/4X	-	125	250	350	-	50	-	THN3365MSS
600A	NEMA Type 4/4X	-	200	400	500	-	50	-	THN3366MSS

¹All mill duty switches accept neutral and auxiliary contact kits. Order from page 4-25.

²Available with viewing window – add “W” suffix. Consult Customer Service for price and availability.



Safety Switches

Double-Throw Switches

Spec-Setter™ Safety Switches

Type TC, Type TDT
 240, 480, 600 Volts AC
 250 Volts DC

Type TC Non-Fused (NEMA 1) and Outdoor (NEMA 3R) Double-Throw Switches

- Designed for application where safety, high performance, and continuity of service are required.
- UL Listed. Products in this section have been tested by UL and shown to meet the construction and performance requirements of UL Standard Number 98, Enclosed and Dead Front Switches. Suitable for use in accordance with Article 702 of the National Electrical Code.
- Meet Federal Specification W-S-865C for enclosed switches; 30-200 amps, Type HD; 400-600 amps, Type LD.
- Meet or exceed NEMA Enclosed Switch Standard KS1 except paragraph 1-4.24 (withstand and short circuit) for Type HD 30-200 amps, Type GD 400-600 amps.
- Seismic Certified (non-fused).
- 60°C and 75°C conductor ratings.
- Quick-make, quick-break mechanisms 30-200 amps; quick break mechanisms 400-600 amps.
- UL Service Entrance rated (NEMA 1 and NEMA 3R).

Type TC Outdoor Emergency Power Transfer Switches

- Designed for residential or light commercial applications where duty is not severe.
- UL Listed. Products in this section have been tested by UL and shown to meet the construction and performance requirements of UL Standard Number 98, Enclosed and Dead Front Switches.
- Meet or exceed NEMA Enclosed Switch Standard KS1 for Type GD.
- Suitable for use as service entrance equipment when installed in accordance with National Electrical Code.
- 60°C and 75°C conductor ratings.
- Not quick-make, quick-break

Type TDT Fusible Double-Throw Safety Switches

- TDT safety switches are suitable for use as service entrance equipment when either neutral kit DT200NK or ground lug kit DS200GK is installed. UL listed (no CSA or cUL).



TC35322, Type TC Indoor Double-throw Switch



TC35321, Type TC Outdoor Double-throw Switch



TC10323R, Type TC Outdoor Emergency Power Transfer Switch

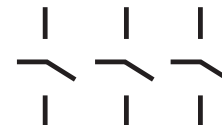

Three-pole, 240 Volts AC, 250 Volts DC, No Fuse



Three-pole, 600 Volts AC, 250 Volts DC, No Fuse



Three-wire SN, 120/240 Volts AC, No Fuse



Four-wire SN, 240 Volts AC, No Fuse



Safety Switches

Double-Throw Switches

Spec-Setter™ Safety Switches

Type TC, Type TDT

240, 480, 600 Volts AC

250 Volts DC

Three-pole, 240 Volts AC, 250 Volts DC, No Fuse

Ampere Rating	Enclosure Type	HP, 240 Vac, NEC Std, 3-ph	HP, 480 Vac, NEC Std, 3-ph	HP, 600 Vac, NEC Std, 3-ph	Lug Wire Size, AWG/kcmil, Cu Only	Product Number
30A	NEMA Type 1	2	-	-	14-8	TC35321
60A	NEMA Type 1	3	-	-	14-4	TC35322
100A	NEMA Type 1	7 1/2	-	-	14-1/0	TC35323
200A	NEMA Type 1	15	-	-	6-250	TC35324
400A	NEMA Type 1	30	-	-	(2)1/0-250 or #2-600	TC35325
600A	NEMA Type 1	50	-	-	(2)3/0-350 or #2-600	TC35326 ²

Three-pole, 240 Volts AC, 250 Volts DC, No Fuse

Ampere Rating	Enclosure Type	HP, 240 Vac, NEC Std, 3-ph	HP, 480 Vac, NEC Std, 3-ph	HP, 600 Vac, NEC Std, 3-ph	Lug Wire Size, AWG/kcmil, Cu Only	Product Number
30A	NEMA Type 3R	2	-	-	14-8	TC35321R
60A	NEMA Type 3R	3	-	-	14-4	TC35322R
100A	NEMA Type 3R	7.5	-	-	14-1/0	TC35323R
200A	NEMA Type 3R	15	-	-	6-250	TC35324R
400A	NEMA Type 3R	30	-	-	(2) 1/0-250 or #2-600	TC35325R

Three-pole, 600 Volts AC, 250 Volts DC, No Fuse

Ampere Rating	Enclosure Type	HP, 240 Vac, NEC Std, 3-ph	HP, 480 Vac, NEC Std, 3-ph	HP, 600 Vac, NEC Std, 3-ph	Lug Wire Size, AWG/kcmil, Cu Only	Product Number
30A	NEMA Type 1	10	10	10	14-4	Use 60A
60A	NEMA Type 1	10	10	10	14-4	TC35362
100A	NEMA Type 1	15	15	15	14-1/0	TC35363
200A	NEMA Type 1	30	30	30	6-250	TC35364
400A	NEMA Type 1	-	-	-	(2)1/0-250 or #2-600	TC35365 ^{1,2,5}
600A	NEMA Type 1	-	-	-	(2)3/0-350 or #2-600	TC35366 ^{1,2}

Three-pole, 600 Volts AC, 250 Volts DC, No Fuse

Ampere Rating	Enclosure Type	HP, 240 Vac, NEC Std, 3-ph	HP, 480 Vac, NEC Std, 3-ph	HP, 600 Vac, NEC Std, 3-ph	Lug Wire Size, AWG/kcmil, Cu Only	Product Number
30A	NEMA Type 3R	10	10	10	14.4	Use 60A
60A	NEMA Type 3R	10	10	10	14-4	TC35362R
100A	NEMA Type 3R	15	15	15	14-1/0	TC35363R
200A	NEMA Type 3R	30	30	30	6-250	TC35364R

240 Volts AC, Fusible

Ampere Rating	Enclosure Type	HP, 240 Vac, Time Delay, 1-ph	HP, 480 Vac, Time Delay, 1-ph	HP, 600 Vac, Time Delay, 1-ph	HP, 240 Vac, Time Delay, 3-ph	HP, 480 Vac, Time Delay, 3-ph	HP, 600 Vac, Time Delay, 3-ph	HP, DC @ 250V	Product Number
30A	NEMA Type 1	3	-	-	7 1/2	-	-	5	TDT3321
60A	NEMA Type 1	10	-	-	15	-	-	10	TDT3322
100A	NEMA Type 1	15	-	-	30	-	-	20	TDT3323
200A	NEMA Type 1	15	-	-	60	-	-	40	TDT3324 ³
400A	NEMA Type 1	-	-	-	125	-	-	50	TDT3325
600A	NEMA Type 1	-	-	-	50	-	-	50	TDT3326 ⁴
30A	NEMA Type 3R	3	7 1/2	10	7 1/2	15	20	5	TDT3321R
60A	NEMA Type 3R	10	20	25	15	30	50	10	TDT3322R
100A	NEMA Type 3R	15	30	40	30	60	75	20	TDT3323R
200A	NEMA Type 3R	15	50	50	60	125	150	40	TDT3324R ³

600 Volts AC, Fusible

Ampere Rating	Enclosure Type	HP, 240 Vac, Time Delay, 1-ph	HP, 480 Vac, Time Delay, 1-ph	HP, 600 Vac, Time Delay, 1-ph	HP, 240 Vac, Time Delay, 3-ph	HP, 480 Vac, Time Delay, 3-ph	HP, 600 Vac, Time Delay, 3-ph	HP, DC @ 250V	Product Number
30A	NEMA Type 1	3	7 1/2	10	7 1/2	15	20	-	TDT3361
60A	NEMA Type 1	10	20	25	15	30	50	-	TDT3362
100A	NEMA Type 1	15	30	40	30	60	75	-	TDT3363
200A	NEMA Type 1	15	50	50	60	125	150	40	TDT3364 ³
400A	NEMA Type 1	-	-	-	125	250	350	50	TDT3365
100A	NEMA Type 3R	15	30	40	30	60	75	20	TDT3363R
200A	NEMA Type 3R	15	50	50	60	125	150	40	TDT3364R ³

¹Not UL Listed.

²Not suitable for use as service equipment per NEC Article 702.

³200 Amp switches move load base for Class J fuses.

⁴600 Amp switch available with Class T fuse provision only.

⁵No provision for auxiliary contact kit.



Safety Switches

Double-Throw Switches

Spec-Setter™ Safety Switches

Type TC Outdoor

240, 480, 600 Volts AC

250 Volts DC

Three-wire SN, 120/240 Volts AC, No Fuse—Emergency Power Transfer Switch

Ampere Rating	Poles	Enclosure Type	Lug Wire Size, AWG/kcmil, Cu/Al	Product Number
100A	2	NEMA Type 3R	12-1	TC10323R
200A	2	NEMA Type 3R	6-250	TC10324R

Four-wire SN, 240 Volts AC, No Fuse—Emergency Power Transfer Switch

Ampere Rating	Poles	Enclosure Type	Lug Wire Size, AWG/kcmil, Cu/Al	Product Number
200A	3	NEMA Type 3R	6-250	TC10424R

Accessories for TDT-Style Fusible Double-Throw Safety Switches (Standard Delivery—4 Weeks)

Accessory Type	Description	Product Number
Control Pole	–	DS16CP
Electrical Interlocks	30-800 A, 1N	DS200EK1
Electrical Interlocks	30-800 A, 2N	DS200EK2
Neutral Kit	30-100 A	DT100NK
Neutral Kit	200 A	DT200NK
Neutral Kit	400-600 A	DS800NK
Class J Fuse Field Conversion Kit	400 A (600 V only)	DT400JK
Equipment Ground Kits	30-100 A Kit	DS100GK
Equipment Ground Kits	200 A Kit	DS200GK
Equipment Ground Kits	400-800 A Kit	DS468GK
Class R Fusing Kit—Field Installable	for 3 Poles 30 A (240V)	DS12FK
Class R Fusing Kit—Field Installable	for 3 Poles 30 & 60 A	DS16FK
Class R Fusing Kit—Field Installable	for 3 Poles 60 A (600V)	DS26FK
Class R Fusing Kit—Field Installable	for 3 Poles 100 A (240V & 600V)	DS36FK
Class R Fusing Kit—Field Installable	for 3 Poles 200 A (240V & 600V)	DS46FK
Class R Fusing Kit—Field Installable	for 3 Poles 400 A (240V & 600V)	DS56FK
Class R Fusing Kit—Field Installable	for 3 Poles 600A (240V & 600V)	DS66FK
T Fuse Clip	for 3 Pole 200A (240V)	DS426TK
T Fuse Clip	for 3 Pole 200A (600V)	DS466TK
T Fuse Clip	for 1 Pole 400A (240V)	DS526TK ¹
T Fuse Clip	for 1 Pole 400A (600V)	DS566TK ¹
T Fuse Clip	for 1 Pole 600A (240V)	DS626TK ¹
T Fuse Clip	for 1 Pole 600A (600V)	DS666TK ¹
Conduit Hub—3"	for 200A Type 3R (240V & 600V)	TC300

¹Order one kit per pole.

Accessories for 240V & 600V TC Non-Fusible Double Throw Safety Switches

Accessory Type	Switch Amp Rating	Description	Voltage	Product Number
Neutral Kits	30	(5) 1/0-14 with bond strap	240	TNK100
Neutral Kits	60	(5) 1/0-14 with bond strap	240	TNK100
Neutral Kits	100	(5) 1/0-14 with bond strap	240	TNK100
Neutral Kits	200	with bond screw	240	TNK200
Neutral Kits	400	(3) 2-600MCM with bond lug	240	TNK400
Neutral Kits	60	(5) 1/0-14 with bond strap	600	TNK100
Neutral Kits	100	(5) 1/0-14 with bond strap	600	TNK100
Neutral Kits	200	with bond screw	600	TNK200
Ground Kits	30	(4) 14-8 AWG CU or 12-8 AWG AL plus (3) 14-4 AWG CU or 6-4 AWG AL		TGL1
Ground Kits	60	(4) 14-8 AWG CU or 12-8 AWG AL plus (3) 14-4 AWG CU or 6-4 AWG AL		TGL1
Ground Kits	100	(3) #12-1/0 AWG CU/AL		TNG3
Ground Kits	200	(3) #12-1/0 AWG CU/AL		TNG3
Ground Kits	400	(3) #2-250MCM CU/AL		TGL6
Ground Kits	600	(3) #2-250MCM CU/AL		TGL6
Auxiliary Contact Kit (field installed)	30-400	Auxiliary Contact Kit - Field installed for NEMA 1 and NEMA 3R TC35XXX Series Switches (unless noted otherwise)		THAUXDT



Safety Switches

Special Purpose Heavy Duty, Type TH

Spec-Setter™ Safety Switches

Section 4

Six-pole Switches

- UL Listed. Products in this section have been tested by UL and shown to meet the construction and performance requirements of UL Standard Number 98, Enclosed and Dead Front Switches.
- Single enclosure rated Type 1, 3R and 5/12.
- Drip hood included.
- Furnished without knockouts or hubs. Order hubs separately (see page 4-29).
- Horsepower rated.
- Quick-make, quick-break.
- Full cover interlocks.
- Equipment ground provided.
- Suitable for four-pole applications.
- 60°C and 75°C conductor ratings.



TH6663, Six-pole Switch

Fusing—UL Listed

- Class H (10,000 rms amps, sym IC) standard.
- Class J (200,000 rms amps, sym IC). See page 4-28 for field conversion details.
- Class R (200,000 rms amps, sym IC). Order appropriate Class R fusing kit (2 kits per switch) from table below.

System Voltage	Fusible	Ampere Rating	Product Number
240Vac, 250Vdc	Yes	30A	TH6621
240Vac, 250Vdc	Yes	60A	TH6622
240Vac, 250Vdc	Yes	100A	TH6623
240Vac, 250Vdc	Yes	200A	TH6624
250Vdc, 480Vac, 600Vac	Yes	30A	TH6661
250Vdc, 480Vac, 600Vac	Yes	60A	TH6662
250Vdc, 480Vac, 600Vac	Yes	100A	TH6663
250Vdc, 480Vac, 600Vac	Yes	200A	TH6664
250Vdc, 480Vac, 600Vac	No	30A	THN6661
250Vdc, 480Vac, 600Vac	No	60A	THN6662
250Vdc, 480Vac, 600Vac	No	100A	THN6663
250Vdc, 480Vac, 600Vac	No	200A	THN6664

Optional Neutrals

Switch Rating (Amperes)	Switch Rating (Volts)	Product Number
30/60	240/600	TNI62
100	240-600	TNI63
200	240-600	TNIJ64

Class R Fuse Kits

Ampere Rating	System Voltage	Product Number
30A	240V	TPBRK12A
30A	600V	TPBRK16A
60A	240V	TPBRK22A
60A	600V	TPBRK26A
100A	240Vac-600Vac	TPBRK36A
200A	240Vac-600Vac	TRK46A



Safety Switches

Special Purpose Heavy Duty, Type TH

Spec-Setter™ Safety Switches

Interlocked Receptacle Switches

- UL Listed. Products in this section have been tested by UL and shown to meet the construction and performance requirements of UL Standard Number 98, Enclosed and Dead Front Switches.
- Meet NEMA Enclosed Safety Switch Standard KS1 for Type HD.
- Type 12 enclosure.
- Furnished without knockouts or hubs. Order hubs separately (see page 4-29).
- Quick-make, quick-break.
- Full cover interlocks.
- 60°C and 75°C conductor ratings.
- Meet horsepower ratings and descriptive data on pages 4-8 through 4-13.

Fusing—UL Listed

- Class H (10,000 rms amps, sym IC) standard.
- Class J (100,000 rms amps, sym IC). See page 4-28 for field conversion details.
- Class R (100,000 rms amps, sym IC). Order appropriate Class R fusing kit from page 4-28.
- Typical application: Portable power supply connection during building construction.
- Interlocked receptacle switches are equipped with 60-amp, three-phase, three-wire grounded type receptacle, prewired and mounted with an interlock linkage to the switch mechanism. The interlock linkage is designed to deter insertion or removal of the plug while the switch is in the “ON” position. It also prevents operation of the switch unless the mating plug is inserted.

Note: Crouse Hinds receptacles use mating plugs that are not supplied with the switch. These can be ordered directly from Crouse Hinds.

Fusible	Receptacle Manufacturer	Mating Plug	Ampere Rating	Product Number
Yes	Crouse Hinds	Arktite #APJ6485	60A	TH3362JCH
No	Crouse Hinds	Arktite #APJ6485	60A	THN3362JCH
Yes	Crouse Hinds	Arktite #APJ6485	60A	TH3362JCHSS

Arktite is a registered trademark of Crouse Hinds Co.



TH3362JCH,
Interlocked Receptacle Switch



Manual Motor Starters

- UL Listed.
- Toggle operated tumbler.
- Copper wire only, 14-10 AWG.
- No overload protection.
- Standard Package = 50 pcs/carton.

No. of Poles	Ampere Rating ¹	System Voltage	HP 110 Vac	HP 240 Vac	HP 480 Vac	HP 600 Vac	Switch Only (no enclosure)	Type 1 Indoor Enclosure
							Product Number	Product Number
2	30A	240Vac	-	2	2	2	TC2228S	TC2228
3	30A	240Vac						
	20A	480Vac	3	7 1/2	15	15	TC2368S	TC2368
	20A	600Vac						

¹2-Pole manual motor starters do not have a general duty rating at 480 Vac or 600 Vac
 Manual motor starters are not rated for Tungsten or DC lamp loads



TC2368S, Manual Motor Starter

Safety Switches

AC Disconnects

Spec-Setter™ Safety Switches

Section 4

Air Conditioner Disconnects

- Puller type
- UL Listed
 - Fusible – UL869
 - Service Equipment
 - No fuse – UL1429
 - Enclosed Pull-out Switch

Enclosure Type ¹	Enclosure Material	Fusible	Ampere Rating	System Voltage	Horsepower Rating	Lug Wire Range AWG		Standard Package	Product Number
						Cu	Al		
NEMA Type 3R	Thermoplastic	Yes	30A	120/240Vac	3	14-3		6	TPF30R
NEMA Type 3R	Thermoplastic	Yes	60A	120/240Vac	10	14-3		6	TPF60R
NEMA Type 3R	Thermoplastic	No	60A	240Vac	10	14-3		6	TPN60R1
NEMA Type 3R	Thermoplastic	Non-automatic	60A	240Vac	10	14-3		6	TPNA60R1
NEMA Type 3R	Steel	Yes	30A	240Vac	3	14-3		6	TF30R
NEMA Type 3R	Steel	Yes	60A	240Vac	10	14-3		6	TF60R
NEMA Type 3R	Steel	No	60A	240Vac	10	14-3		6	TFN60R
NEMA Type 3R	Steel	Non-automatic	60A	240Vac	10	14-3		6	TNA60R1
NEMA Type 3R	Steel	No	60A	240Vac	10	14-3		6	TFN60RGFR ²
NEMA Type 3R	Steel	Non-automatic	60A	240Vac	10	14-3		6	TNA60RGFR ²

¹Devices do not have removable closing cap.

²These AC disconnects include a GFCI outlet.



TPF60R, Air Conditioner Disconnect, Thermoplastic Enclosure



TFN60R, Air Conditioner Disconnect, Steel Enclosure



TNA60RGFR



TFN60RGFR

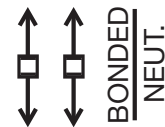

Fusible

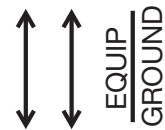

No Fuse



Non-automatic



Safety Switches

Accessories: NEMA Type 1 and 3R Enclosures

Section 4

Spec-Setter™ Safety Switches
 30-600 Amperes: TG and TH
 800-1200 Amperes: TC



TGL1 Equipment Ground Kit

Equipment Ground Kits

Ampere Rating	Wire Range AWG/kcmil Copper	Wire Range AWG/kcmil Aluminum	Standard Package	Product Number
30A	(4) 14-8, (3) 14-4	(4) 14-8, (3) 6-4	20	TGL1
60A				
100A	(3) 10-1/0	(3) 10-1/0	1	TNG3
200A				
600A	(3) 2-250	(3) 2-250	1	TGL6
400A				

Neutral Kit Insulated, Groundable and Bondable

Ampere Rating	System Voltage	Fusible	Wire Range AWG/kcmil Copper	Wire Range AWG/kcmil Aluminum	Standard Package	Product Number
30A	240Vac					TNI21
30A	600Vac		12-2	12-2	1	TNI62 ¹
60A		Yes	12-2	12-2	1	TNIA62
100A		Yes	10-1/0	10-1/0	1	TNIA63
100A		No	10-1/0	10-1/0	1	TNI63 ¹
200A			2-250	2-250	1	TNIA64
400A			(1) 2-600 or (2) 1/0-250	(1) 2-600 or (2) 1/0-250	1	TNI65
400A			(1) 350-800	(1) 350-800	1	TNI65A
600A			(2) 4-500	(2) 4-500	1	TNI66
800A			(3) 2-600 or (6) 1/0-250	(3) 2-600 or (6) 1/0-250	1	TNI67
1200A			(4) 3/0-800	(4) 3/0-800	1	TNI68A



TNG3 Equipment Ground Kit

Switching Neutral: Order standard switch of required number of poles and use dummy fuse in neutral pole.

¹Not suitable for type TG switches.

Lug Wire Sizes Line and Load Terminals

Ampere Rating	Wire Range AWG/kcmil Copper	Wire Range AWG/kcmil Aluminum
30A (250V)	14-8	12-8
30A (600V)	12-2	12-2
60	12-2	12-2
100	10-1/0	10-1/0
200	2-250	2-250
400	(1) 2-600 or (2) 1/0-250	(1) 2-600 or (2) 1/0-250
600	(2) 4-500	(2) 4-500
800	(3) 2-600 or (6) 1/0-250	(3) 2-600 or (6) 1/0-250
1200	(4) 3/0-800	(4) 3/0-800



Safety Switches

Accessories: NEMA Type 1 and 3R Enclosures

Spec-Setter™ Safety Switches
30-600 Amperes: TH and THN

Auxiliary Contact Kits

- UL Listed for field installation.
- Auxiliary contacts open before switch blades.
- Standard Package = 1.

Series Prefix	Ampere Rating	No. of Poles	Contacts	Contact Ratings	Product Number
TH,THN	30A	2	DPDT	10A, 125/250Vac 0.30A, 125Vdc 0.15A, 250Vdc	THAUX21D
		3			
TH,THN	30A	2	SPDT	15A, 600Vac 0.50A, 125Vdc 0.25A, 250Vdc	THAUX61S
		3			
TH,THN	60A	2	DPDT	15A, 600Vac 0.50A, 125Vdc 0.25A, 250Vdc	THAUX64D
	100A	3			
	200A				
TH,THN	400A	2	DPDT	15A, 600Vac 0.50A, 125Vdc 0.25A, 250Vdc	THAUX66D
	600A	3			
TH,THN	30A	6	DPDT	15A, 600Vac 0.50A, 125Vdc 0.25A, 250Vdc	THAUX66D
	60A				
	100A				
TH,THN	200A	6	DPDT	15A, 600Vac 0.50A, 125Vdc 0.25A, 250Vdc	THAUX66D2

Contact Pilot Duty Ratings - 600 Volt Kits

Volts	Inrush Current			DC (Resistive)	
	N.C.	N.O.	AC Break Normal Current	Volts	Break Normal Current
115	30	15	15	125	0.5
230	30	15	250	0.25	
460	30	15	15	-	-
575	15	15	2	-	-

Semidust-tight Door Gasket Kits

Types TH Indoor, TG and TH Outdoor Switches. Product Number listed is for field mounted kit.

Ampere Rating	Standard Package	Product Number
30A	1	THG106
60A		
100A		
200A	1	THG107
600A	1	THG108
400A		



Safety Switches

Accessories: NEMA Type 4/4X, 12 and Mill Duty Enclosures

Section 4

Spec-Setter™ Safety Switches
30-600 Amperes: TH

Lug Wire Sizes

Line and Load Terminals

Switch Ampere Rating	Factory Installed		Field Installed Crimp Lugs (See Table on page 4-27)	
	Copper	Aluminum	Copper	Aluminum
30A-240V	14-8	12-8	-	-
30A-600V	14-6	14-6	14-8	-
60	14-2	14-2	8-4	-
100	14-1/0	12-1/0	6-1/0	6-2/0
200	6-250	-	1/0-250	-
400	(1) 2-600 or (2) 1/0-250	-	(2) 300-600 or (1) 750	(2) 250-600 or (1) 750
600	(2) 4-600	-	(2) 300-600 or (1) 750	(2) 250-600 or (1) 750

Equipment Ground Terminals—Two lugs supplied per switch, provision for one additional lug.

30	14-6	14-6	14-8	-
60	14-6	14-6	14-8	-
100	14-4	14-4	8	6
200	14-4	14-4	6	4
400	14-1/0	12-1/0	3-2	1
600	14-2/0	14-2/0	1	2/0

Auxiliary Contact Kits

Auxiliary contacts designed to open before switch blades. UL Listed for field installation. Product number listed is for field installed kit.

Series Prefix	Ampere Rating	System Voltage	Standard Package	Contacts	Product Number
TH, THN	30A	240V	1	DPDT	THAUX21D
TH, THN	30A	240V	1	SPDT	THAUX61S
TH, THN	30A	600V	1	DPDT	THAUX64D
TH, THN	60-200A	240-600V	-	-	-
TH, THN	400-600A	240-600V	1	DPDT	THAUX66D

For Contact Pilot Duty Ratings, see page 4-25.

Optional Copper Lug Neutrals

Ampere Rating	Fusible	Lug Wire Size, AWG/kcmil, Cu Only	Standard Package	Product Number
30A-60A	No	14-2	1	TNIJA62CL

Neutral Kit Insulated, Groundable and Bondable

Ampere Rating	System Voltage	Fusible	Lug Wire Size AWG/kcmil Factory Installed Aluminum	Lug Wire Size AWG/kcmil Factory Installed Copper	Lug Wire Size AWG/kcmil Field Installed Crimp Lugs Copper	Lug Wire Size AWG/kcmil Field Installed Crimp Lugs Aluminum	Standard Package	Product Number
30A	240Vac	Yes	12-8	14-8	-	-	-	TNI21
30A	600Vac ¹	Yes/No	14-6	14-6	14-8	-	1	TNIJ61
60A	600Vac ²	Yes	14-2	14-2	8-4	-	1	TNIJ62
60A	240Vac ²	Yes	14-2	14-2	8-4	-	1	TNIJ62
60A	600Vac	Yes	14-2	14-2	8-4	-	1	TNIJ62
60A	600Vac ²	No	14-2	14-2	8-4	-	1	TNIJA62
60A	600Vac	No	14-2	14-2	8-4	-	1	TNIJA62
100A	240-600Vac	-	12-1/0	14-1/0	6-1/0	6-2/0	1	TNIJ63
200A	240-600Vac	-	6-250	6-250	1/0-250	1/0-250	1	TNIJ64
400-600A	240-600Vac	-	(2) 4-600	(2) 4-600	(2) 300-600 or (1) 750	(2) 250-600 or (1) 750	1	TNIJ66

¹Type 4, 4x, 12

²Mill duty type



Safety Switches

Section 4

Accessories: NEMA Type 4/4X, 12 and Mill Duty Enclosures

Spec-Setter™ Safety Switches

30-600 Amperes: TH

Crimp-type Connectors - Field Replaceable

(Obtain from normal source. Not furnished with switches.)

Line and Load Terminals

Switch Ampere Rating	Lug Wire Size AWG/kcmil	Thomas and Betts Product Number		Burdny Product Number	
		Copper	Aluminum	Copper	Aluminum
30	14-12	-	-	YAV12 G2	-
30	12-10	-	-	YAV10	-
30	8	54104	-	YAV8C-L	-
60	8	54130	-	YAV8C-L1	-
60	6	54105	-	YAV6C-L	-
60	4	54106	-	YAV4CLY1	-
100	6	54105	60107	-	-
100	4	54106	60112	-	-
100	2	54017	60116	-	-
100	1	54108	60122	-	-
100	1/0	-	-	YA25-L	YA25A1
200	1/0	54153	60129	-	-
200	1/0	54109	60130	-	-
200	2/0	54158	60135	-	-
200	2/0	54110	60136	-	-
200	3/0	54163	60141	-	-
200	3/0	54111	60142	-	-
200	4/0	54168	60147	-	-
200	4/0	54112	60148	-	-
200	250	54173	60153	-	-
200	250	54174	60154	-	-
400 and 600	250	-	60156	-	-
400 and 600	300	54114	60162	-	-
400 and 600	350	54115	60165	-	-
400 and 600	400	54116	-	-	-
400 and 600	500	54118	60171	-	-
400 and 600	600	54120	60174	-	-
400 and 600	750	54123	60178	-	-

Equipment Ground Terminals (provision for three per switch)

30	10	-	-	YAV10	-
30	8	54104	-	-	-
60	8	54104	-	YAV8C-L	-
100	8	54105	-	YAV8C-L	-
100	6	-	60106	-	-
200	6	54105	-	-	-
200	4	-	60112	-	-
400	3-2	54107	-	-	-
400	1	-	60122	-	-
600	1	54108	-	-	-
600	2/0	-	60134	-	-



Class J Fuse Field Conversion Kit UL Listed

TH switches, 30-400 amperes, 600 volt and 100-400 amperes, 240 volt, may be adapted to accept Class J fuses without a kit by moving the load-block toward the switch base and remounting. One kit required per two-pole or three-pole switch.

Series Prefix	Ampere Rating	System Voltage	Product Number
TH	600A	240Vac 600Vac	THJ6

Class R Fusing Kit—Field Installable Type TH, UL Listed

When specifications permit only Class R fuses to be used, these kits may be installed in the safety switch to deter fuses other than Class R from being installed. Kits for 30 or 60A switches incorporate replacement fuse clips. Kits for 100-600A switches incorporate rejection pins that assemble to the standard fuse clips.

Enclosure Type	Ampere Rating	System Voltage	Product Number
NEMA Type 1, 3R, 4/4X, 12	30A	240Vac	TRK12B
NEMA Type 1, 3R	30A	600Vac	TRK16B
NEMA Type 4/4X, 12	30A	600Vac	TRK16SA
NEMA Type 1, 3R, 4/4X, 12	60A	240Vac	TRK22A
NEMA Type 1, 3R, 4/4X, 12	60A	600Vac	TRK26A
NEMA Type 1, 3R	100A	240Vac 600Vac	TRK46A ¹
NEMA Type 4/4X, 12	100A	240Vac 600Vac	TPBRK36A
NEMA Type 1, 3R, 4/4X, 12	200A	240Vac 600Vac	TRK46A
NEMA Type 1, 3R, 4/4X, 12	400A	240Vac 600Vac	TRK56A
NEMA Type 1, 3R, 4/4X, 12	600A	240Vac 600Vac	TRK66A

¹Starting August 2011.



Class R Fuse Kit—Field Installable Type TG, UL Listed

When specifications permit only Class R fuses to be used, these kits may be installed in the safety switch to deter fuses other than Class R from being installed. Kits for 30 or 60A switches incorporate replacement fuse clips. Kits for 100-200A switches incorporate rejection pins that assemble to the standard fuse clips.

Enclosure Type	Ampere Rating	Product Number
NEMA Type 1, 3R	30A	TGRK12
NEMA Type 1, 3R	60A	TGRK22
NEMA Type 1, 3R	100A	TGRK42 ¹
NEMA Type 1, 3R	200A	TGRK42

Universal Raintight Aluminum Hubs

For outdoor enclosures that have removable closing caps.

Nominal Conduit Diameter (in.)	Standard Package	Product Number
3/4	10	TC75
1	10	TC100
1 1/4	10	TC125
1 1/2	10	TC150
2	10	TC200
2 1/2	10	TC250



TC200 Universal Raintight Hub

Closing Cap for Universal Raintight Aluminum Hub

Standard Package	Product Number
10	TCCP

Replacement Red Handle Grip for HD Switches

Product Number
THGRIP

¹Starting August 2011.



Safety Switches Enclosure Dimensions

Spec-Setter™ Safety Switches

TG, TH and TS, NEMA Type 1 and 3R Enclosures

Section 4

NEMA Type 1 TG Approximate Dimensions in Inches Figure 1

Product Number	Dimension W	Dimension H	Dimension D	Dimension W2	KO Figure Number ¹
TG3221	6 1/2	10 5/8	3 5/16	7	1
TG3222	8 1/2	13 7/8	4	9	15
TG3223	9 1/2	21 3/8	5	10	3
TG3224	13 3/4	29 1/4	5 1/2	14	4
TG3225	22	49 1/2	9	23	5
TG3226	23 1/4	50	9 1/4	23 3/4	6
TG3325	22	49 1/2	9	23	7
TG3326	23 1/4	50	9 1/4	23 3/4	6
TG4321	6 1/2	10 5/8	3 5/16	7	1
TG4322	8 1/2	13 7/8	4	9	15
TG4323	9 1/2	21 3/8	5	10	3
TG4324	13 3/4	29 1/4	5 1/2	14	4
TG4325	22	49 1/2	9	23	7
TG4326	23 1/4	50	9 1/4	23 3/4	6
TGN3321	6 1/2	10 5/8	3 5/16	7	1
TGN3322	8 1/2	13 7/8	4	9	15
TGN3323	9 1/2	21 3/8	5	10	3
TGN3324	13 3/4	29 1/4	5 1/2	14	4
TGN3325	22	49 1/2	9	23	7
TGN3326	23 1/4	50	9 1/4	23 3/4	6

¹See page 4-32.

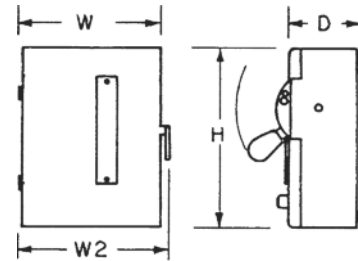

Figure 1

NEMA Type 1 TH Approximate Dimensions in Inches Figure 2

Product Number	Dimension W	Dimension H	Dimension D	Dimension W2	KO Figure Number ¹
TH3221	6 1/2	10 3/8	3 3/8	7 1/8	1
TH3222	9 1/2	17 5/8	5	10 1/8	3
TH3223	9 3/8	19 3/8	5 1/16	10 1/4	3
TH3224	13 1/2	25 3/8	5 1/16	14 1/4	4
TH3225	23 1/5	50 7/8	8 3/8	15 1/4	6
TH3226	24 5/8	59 9/16	8 3/8	25 3/4	6
TH3325	23 1/4	50 7/8	8 3/8	24 1/4	6
TH3326	23 1/4	50 7/8	8 3/8	24 1/4	6
TH4321	6 1/2	10 3/8	3 3/8	7 1/8	1
TH4322	9 1/2	17 5/8	5	10 1/8	3
TH4323	9 1/2	21 3/8	5	10 1/8	3
TH4324	13 5/8	31 5/8	5 1/4	14 1/2	4
TH4325	23 1/4	50 7/8	8 3/8	24 1/4	6
TH4326	23 1/4	50 7/8	8 3/8	24 1/4	6
TH2261DC	8 5/8	12 5/8	4	9 1/2	15
TH2262DC	9 1/2	21 3/8	5	10 1/8	3
TH2263DC	9 1/2	22 3/4	5	10 1/8	14
TH3361	8 5/8	12 5/8	4	9 1/2	15
TH3362	9 1/2	21 3/8	5	10 1/8	3
TH3363	9 1/2	22 3/4	5	10 1/8	14
TH3364	13 5/8	31 5/8	5 1/4	14 1/2	4
TH3365	23 1/4	54	8 3/8	24 1/2	6
TH3366	23 1/4	54	8 3/8	24 1/2	6
THN2261DC	8 1/2	10 9/16	4	9 1/4	15
THN2262DC	9 1/2	17 5/8	5	10 1/8	3
THN2263DC	9 1/2	17 5/8	5	10 1/8	3
THN3321	6 1/2	10 3/8	3 3/8	7 1/8	1
THN3361	8 1/2	10 9/16	4	9 1/4	15
THN3362	9 1/2	17 5/8	5	10 1/8	3
THN3363	9 1/2	17 5/8	5	10 1/8	3
THN3364	13 5/8	31 5/8	5 1/4	14 1/2	4
THN3365	23 1/4	42 1/2	8 3/8	24 1/2	6
THN3366	23 1/4	42 1/2	8 3/8	24 1/2	6

¹See page 4-32.

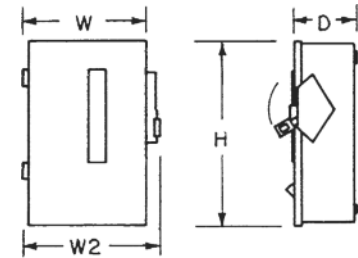

Figure 2



Safety Switches Enclosure Dimensions

Spec-Setter™ Safety Switches
TG, TH and TS, NEMA Type 1 and 3R Enclosures

Section 4

NEMA Type 3R TG Approximate Dimensions in Inches Figure 3

Product Number	Dimension W	Dimension H	Dimension D	Dimension W2	KO Figure Number ¹
TG3221R	6 7/8	9 7/8	3 5/16	7 1/4	8
TG3222R	8 3/4	13 3/4	4	9 1/4	19
TG3223R	9 7/8	21 1/4	5	10	10
TG3224R	13 3/8	28 3/4	5 1/4	14 1/4	11
TG3225R	22 1/4	49 1/2	9	22 1/2	12
TG3226R	23 5/8	50	9 1/4	23 3/4	13
TG3325R	22 1/4	49 1/2	9	22 1/2	12
TG3326R	23 5/8	50	9 1/4	23 3/4	13
TG4321R	6 7/8	9 7/8	3 5/16	7 1/4	8
TG4322R	8 3/4	13 3/4	4	9 1/4	19
TG4323R	9 7/8	21 1/4	5	10	10
TG4324R	14	29	5 3/8	14 1/4	11
TGN3321R	6 7/8	9 7/8	3 5/16	7 1/4	8
TGN3322R	8 3/4	13 3/4	4	9 1/4	19
TGN3323R	9 1/4	15 1/2	5	10 1/4	10
TGN3324R	13 3/8	28 3/4	5 1/4	14 1/4	11

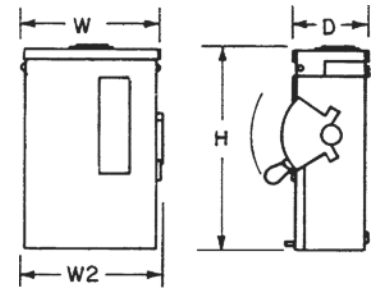

Figure 3

¹See page 4-32.

NEMA Type 3R TH Approximate Dimensions in Inches Figure 4

Product Number	Dimension W	Dimension H	Dimension D	Dimension W2	KO Figure Number ¹
TH3221R	6 7/8	10 5/8	3 5/16	7 1/8	8
TH3222R	9 3/8	19 3/8	5 1/16	10 1/4	10
TH3223R	13 1/2	25 3/8	5 1/16	14 1/4	10
TH3224R	14 1/2	35 1/8	5 5/16	15 1/4	11
TH3225R	24 5/8	59 9/16	8 3/8	25 3/4	18
TH3226R	23 1/2	53 1/4	8 3/8	24 1/4	18
TH3325R	23 1/2	49 1/8	8 3/8	24 1/4	18
TH3326R	23 1/2	53 1/4	8 3/8	24 1/4	18
TH4321R	6 7/8	10 5/8	3 5/16	7 1/8	8
TH4322R	9 7/8	17 1/2	5	10 1/8	10
TH4323R	9 7/8	22 1/4	5	10 5/8	10
TH4324R	14	31 1/2	5 5/16	14 1/8	11
TH2261RDC	8 7/8	13 1/4	4	9 1/2	19
TH2262RDC	9 7/8	22 1/4	5	10 5/8	10
TH2263RDC	9 7/8	22 1/4	5	10 5/8	10
TH3361R	8 7/8	13 1/4	4	9 1/2	19
TH3361RF	10 2/5	15	4 1/8	11 3/10	-
TH3361RF2	13 2/5	22 1/2	5 1/8	14 3/8	-
TH3362R	9 7/8	22 1/4	5	10 5/8	10
TH3362RF	13 2/5	22 1/2	5 1/8	14 3/8	-
TH3363R	9 7/8	22 1/4	5	10 5/8	10
TH3364R	14	31 1/2	5 5/16	14 1/8	11
TH3365R	23 1/2	53 1/4	8 3/8	24 1/4	18
TH3366R	23 1/2	53 1/4	8 3/8	24 1/4	18
THN2261RDC	8 7/8	13 1/4	4	9 1/2	19
THN2262RDC	9 7/8	17 1/2	5	10 1/8	10
THN2263RDC	9 7/8	17 1/2	5	10 1/8	10
THN3361R	8 7/8	13 1/4	4	9 1/2	19
THN3361RF	10 2/5	15	4 1/8	11 3/10	-
THN3362R	9 7/8	17 1/2	5	10 1/8	10
THN3362RF	13 2/5	22 1/2	5 1/8	14 3/8	-
THN3363R	9 7/8	17 1/2	5	10 1/8	10
THN3364R	14	31 1/2	5 5/16	14 1/8	11
THN3365R	23 1/2	49 1/8	8 3/8	24 1/4	18
THN3366R	23 1/2	53 1/4	8 3/8	24 1/4	18

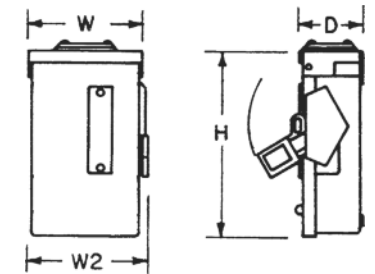

Figure 4

¹See page 4-32.



Safety Switches Knockouts

Spec-Setter™ Safety Switches
TG and TH, NEMA Type 1 and 3R Enclosures

Section 4

Dimensions—Knockouts

Symbol	A	B	C	D	E	F	G	H	J	K	L	M	N
Conduit Size (Inches)	9/32	1/2	1/2	1/2	1/2	1/2	3/4	3/4	1	1	2	2	2 1/2
	—	—	3/4	3/4	3/4	3/4	1	1	1 1/4	1 1/2	2 1/2	2 1/2	3
	—	—	—	1	1	1	—	1 1/4	1 1/2	2	3	3	—
	—	—	—	—	1 1/4	1 1/2	—	1 1/2	2	2 1/2	—	3 1/2	—

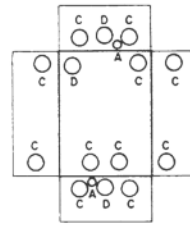

Figure 1

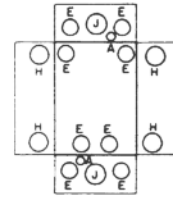

Figure 2

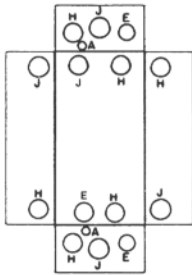

Figure 3

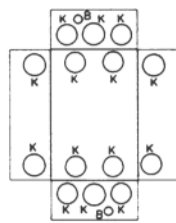

Figure 4

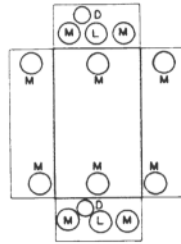

Figure 5

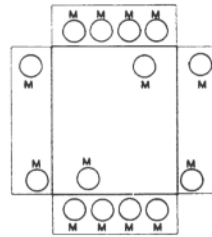

Figure 6

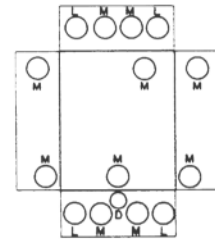

Figure 7

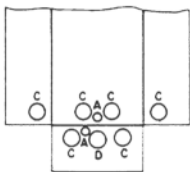

Figure 8

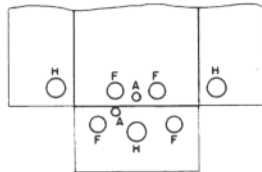

Figure 9

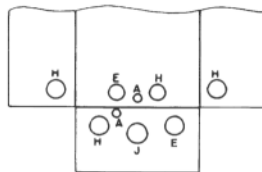

Figure 10

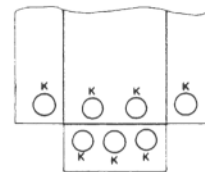

Figure 11

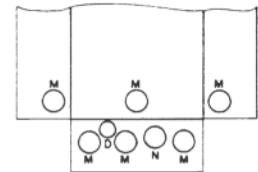

Figure 12

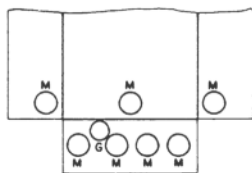

Figure 13

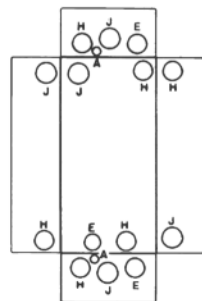

Figure 14

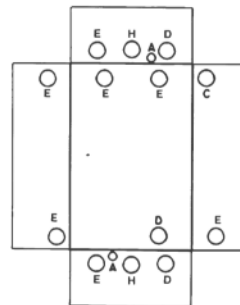

Figure 15

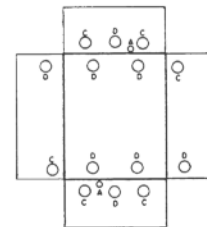

Figure 16

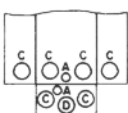

Figure 17

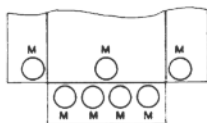

Figure 18

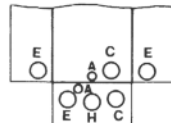

Figure 19



Safety Switches Enclosure Dimensions

Spec-Setter™ Safety Switches
TH NEMA Type 4/4X, 12 and Mill Duty Enclosures

Section 4

NEMA Type 4/4X TH Approximate Dimensions in Inches Figure 1

Product Number	Dimension W	Dimension H	Dimension D	Dimension W2
TH2221SS	7 3/8	11 3/8	5 1/16	8 1/8
TH2222SS	9 3/8	19 3/8	5 1/16	10 1/4
TH2261SSDC	9 3/8	13 3/8	5 5/16	10 1/4
TH2262SSDC	9 3/8	19 3/8	5 5/16	10 1/4
TH2263SSDC	13 1/2	25 3/8	5 5/16	14 1/4
TH3221SS	7 3/8	11 3/8	5 1/16	8 1/8
TH3222SS	9 7/8	17 1/2	5	10 1/8
TH3223SS	9 7/8	22 1/4	5	10 5/8
TH3224SS	14	31 1/2	5 5/16	14 1/8
TH3225SS	23 1/2	49 1/8	8 3/8	24 1/4
TH3226SS	24 5/8	59 9/16	8 3/8	25 3/4
TH3321SS	7 3/8	11 3/8	5 5/16	8 1/8
TH3322SS	9 3/8	19 3/8	5 5/16	10 1/4
TH3361SS	9 3/8	13 3/8	5 5/16	10 1/4
TH3362SS	9 3/8	19 3/8	5 5/16	10 1/4
TH3363SS	13 1/2	25 3/8	5 5/16	14 1/4
TH3364SS	14 1/2	35 1/8	5 5/16	15 1/4
TH3365SS	24 5/8	59 9/16	8 3/8	25 3/4
TH3366SS	24 5/8	59 9/16	8 3/8	25 3/4
TH4321SS	7 3/8	11 3/8	5 1/16	8 1/8
TH4322SS	9 3/8	19 3/8	5 1/16	10 1/4
TH4323SS	13 1/2	25 3/8	5 1/16	14 1/4
TH4324SS	13 1/2	35 1/8	5 5/16	15 1/4
TH4325SS	24 5/8	59 9/16	8 3/8	25 3/4
TH4326SS	24 5/8	59 9/16	8 3/8	25 3/4
THN2261SSDC	9 3/8	13 3/8	5 1/16	10 1/4
THN2262SSDC	9 3/8	19 3/8	5 1/16	10 1/4
THN2263SSDC	13 1/2	25 3/8	5 5/16	14 1/4
THN3361SS	9 3/8	13 3/8	5 1/16	10 1/4
THN3362SS	9 3/8	19 3/8	5 1/16	10 1/4
THN3363SS	13 1/2	25 3/8	5 5/16	14 1/4
THN3364SS	14 1/2	35 1/8	5 5/16	15 1/4
THN3365SS	24 5/8	59 9/16	8 3/8	25 3/4
THN3366SS	24 5/8	59 9/16	8 3/8	25 3/4

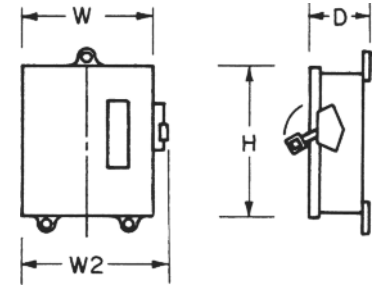

Figure 1

NEMA Type 12 TH Approximate Dimensions in Inches Figure 1

Product Number	Dimension W	Dimension H	Dimension D	Dimension W2
TH2221J	7 3/8	11 3/8	5 1/16	8 1/8
TH2222J	9 3/8	19 3/8	5 1/16	10 1/4
TH2261JDC	9 3/8	13 3/8	5 5/16	10 1/4
TH2262JDC	9 3/8	19 3/8	5 5/16	10 1/4
TH2263JDC	13 1/2	25 3/8	5 5/16	14 1/4
TH3221J	7 3/8	11 3/8	5 1/16	8 1/8
TH3222J	23 1/4	50 7/8	8 3/8	24 1/4
TH3223J	9 1/2	21 3/8	5	10 1/8
TH3224J	13 5/8	31 5/8	5 1/4	14 1/2
TH3225J	23 1/4	50 7/8	8 3/8	24 1/4
TH3226J	24 5/8	59 9/16	8 3/8	25 3/4
TH3321J	7 3/8	11 3/8	5 5/16	8 1/8
TH3322J	9 3/8	19 3/8	5 5/16	10 1/4
TH3361J	9 3/8	13 3/8	5 5/16	10 1/4
TH3362J	9 3/8	19 3/8	5 5/16	10 1/4
TH3363J	13 1/2	25 3/8	5 5/16	14 1/4
TH3364J	14 1/2	35 1/8	5 5/16	15 1/4
TH3365J	24 5/8	59 9/16	8 3/8	25 3/4
TH3366J	24 5/8	59 9/16	8 3/8	25 3/4
TH4321J	7 3/8	11 3/8	5 1/16	8 1/8
TH4322J	9 3/8	19 3/8	5 1/16	10 1/4
TH4323J	13 1/2	25 3/8	5 1/16	14 1/4
TH4324J	13 1/2	35 1/8	5 5/16	15 1/4
TH4325J	24 5/8	59 9/16	8 3/8	25 3/4
TH4326J	24 5/8	59 9/16	8 3/8	25 3/4
THN2261JDC	9 3/8	13 3/8	5 1/16	10 1/4
THN2262JDC	9 3/8	19 3/8	5 1/16	10 1/4
THN2263JDC	13 1/2	25 3/8	5 5/16	14 1/4
THN3361J	9 3/8	13 3/8	5 1/16	10 1/4
THN3362J	9 3/8	19 3/8	5 1/16	10 1/4
THN3363J	13 1/2	25 3/8	5 5/16	14 1/4
THN3364J	14 1/2	35 1/8	5 5/16	15 1/4
THN3365J	24 5/8	48 1/16	8 3/8	25 3/4
THN3366J	24 5/8	48 1/16	8 3/8	25 3/4



Safety Switches Enclosure Dimensions

Spec-Setter™ Safety Switches

TH NEMA Type 4/4X, 12 and Mill Duty Enclosures

Section 4

Mill Duty TH Approximate Dimensions in Inches Figure 1

Product Number	Dimension W	Dimension H	Dimension D	Dimension W2
TH2221M	7 3/8	11 3/8	5 1/16	9 1/4
TH2222M	9 3/8	19 3/8	5 1/16	11 1/4
TH2223M	13 1/2	25 3/8	5 1/16	15 1/4
TH2224M	14 1/2	35 1/8	5 5/16	16 1/4
TH2221MSS	7 3/8	11 3/8	5 1/16	9 1/4
TH2222MSS	9 3/8	19 3/8	5 1/16	11 1/4
TH2223MSS	13 1/2	25 3/8	5 1/16	15 1/4
TH2224MSS	14 1/2	35 1/8	5 5/16	16 1/4
TH2261MDC	9 3/8	19 3/8	5 5/16	11 1/4
TH2262MDC	9 3/8	19 3/8	5 5/16	11 1/4
TH2263MDC	13 1/2	25 3/8	5 5/16	15 1/4
TH3321M	7 3/8	11 3/8	5 1/16	9 1/4
TH3322M	9 3/8	19 3/8	5 1/16	11 1/4
TH3323M	13 1/2	25 3/8	5 1/16	15 1/4
TH3324M	14 1/2	35 1/8	5 5/16	16 1/4
TH3325M	24 5/8	59 9/16	8 3/8	25 3/4
TH3326M	24 5/8	59 9/16	8 3/8	25 3/4
TH3321MSS	7 3/8	11 3/8	5 1/16	9 1/4
TH3322MSS	9 3/8	19 3/8	5 1/16	11 1/4
TH3323MSS	13 1/2	25 3/8	5 1/16	15 1/4
TH3324MSS	14 1/2	35 1/8	5 5/16	16 1/4
TH3325MSS	24 5/8	59 9/16	8 3/8	25 3/4
TH3326MSS	24 5/8	59 9/16	8 3/8	25 3/4
TH3361M	9 3/8	19 3/8	5 5/16	11 1/4
TH3362M	9 3/8	19 3/8	5 5/16	11 1/4
TH3363M	13 1/2	25 3/8	5 5/16	15 1/4
TH3364M	14 1/2	35 1/8	5 5/16	16 1/4
TH3365M	24 5/8	59 9/16	8 3/8	25 3/4
TH3366M	24 5/8	59 9/16	8 3/8	25 3/4
TH3361MSS	9 3/8	19 3/8	5 5/16	11 1/4
TH3362MSS	9 3/8	19 3/8	5 5/16	11 1/4
TH3363MSS	13 1/2	25 3/8	5 5/16	15 1/4
TH3364MSS	14 1/2	35 1/8	5 5/16	16 1/4
TH3365MSS	24 5/8	59 9/16	8 3/8	25 3/4
TH3366MSS	24 5/8	59 9/16	8 3/8	25 3/4
THN2261MDC	9 3/8	13 3/8	5 5/16	11 1/4
THN2262MDC	9 3/8	19 3/8	5 5/16	11 1/4
THN2263MDC	13 1/2	25 3/8	5 5/16	15 1/4
THN3361M	9 3/8	19 3/8	5 5/16	11 1/4
THN3362M	9 3/8	19 3/8	5 5/16	11 1/4
THN3363M	13 1/2	25 3/8	5 5/16	15 1/4
THN3364M	14 1/2	35 1/8	5 5/16	16 1/4
THN3361MSS	9 3/8	19 3/8	5 5/16	11 1/4
THN3362MSS	9 3/8	19 3/8	5 5/16	11 1/4
THN3363MSS	13 1/2	25 3/8	5 5/16	15 1/4
THN3364MSS	14 1/2	35 1/8	5 5/16	16 1/4
THN3365M	24 5/8	48 1/16	8 3/8	25 3/4
THN3365MSS	24 5/8	59 9/16	8 3/8	25 3/4
THN3366M	24 5/8	48 1/16	8 3/8	25 3/4
THN3366MSS	24 5/8	59 9/16	8 3/8	25 3/4

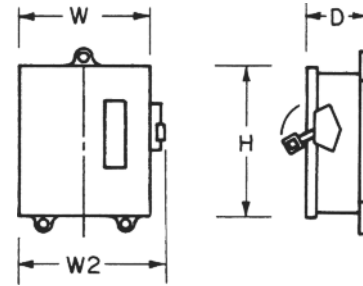

Figure 1



Safety Switches Enclosure Dimensions

Spec-Setter™ Safety Switches
TH NEMA Type 4/4X, 12 and Mill Duty Enclosures

Copper Lug THR Approximate Dimensions in Inches Figure 1

Product Number	Dimension W	Dimension H	Dimension D	Dimension W2
THN3361JCL	9 3/8	19 3/8	5 5/16	10 1/4
THN3363JCL	13 1/2	25 3/8	5 5/16	14 1/4
THN3365JCL	24 5/8	48 1/16	8 3/8	25 3/4
THN3366JCL	24 5/8	48 1/16	8 3/8	25 3/4

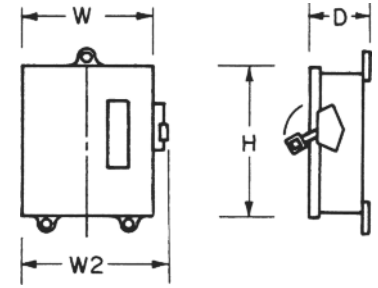

Figure 1

6-pole TH Approximate Dimensions in Inches Figure 1

Product Number	Dimension W	Dimension H	Dimension D	Dimension W2
TH6621	19	14 5/8	6	19 3/4
TH6622	19	24 1/8	6	19 3/4
TH6623	19	24 1/8	6	19 3/4
TH6624	26 1/4	35 3/8	6	27
TH6661	19	14 5/8	6	19 3/4
TH6662	19	24 1/8	6	19 3/4
TH6663	19	24 1/8	6	19 3/4
TH6664	26 1/4	35 3/8	6	27
THN6661	19	14 5/8	6	19 3/4
THN6662	19	24 1/8	6	19 3/4
THN6663	19	24 1/8	6	19 3/4
THN6664	26 1/4	35 3/8	6	27

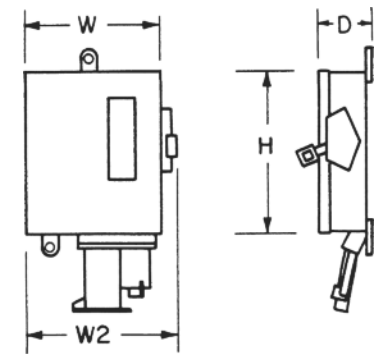

Figure 2

Receptacle TH Approximate Dimensions in Inches Figure 2

Product Number	Dimension W	Dimension H	Dimension D	Dimension W2
TH3362JCH	9 3/8	19 3/8	5 5/16	10 1/4
THN3362JCH	9 3/8	19 3/8	5 5/16	10 1/4



Safety Switches Enclosure Dimensions

Spec-Setter™ Safety Switches

TC, TDT, TPF and TPN

NEMA Type 1 and 3R Enclosures

Section 4

NEMA Type 1 TC Double Throw Approximate Dimensions in Inches Figure 1

Product Number	Dimension W	Dimension H	Dimension D	Dimension W2	KO Figure Number ¹
TC35321	10.37	15.81	5.33	12.04	7
TC35322	11.37	18.75	6.43	13.10	7
TC35323	14.37	22.37	8.06	16.12	9
TC35324	17.87	30.12	9.15	19.88	10
TC35325	24.40	34.31	10.52	26.94	10
TC35326	23.50	44.38	9.25	26.00	12
TC35362	11.37	18.75	6.43	13.10	7
TC35363	14.37	22.37	8.06	16.12	9
TC35364	17.87	30.12	9.15	19.88	10
TC35365	20.44	34.31	8.25	22.90	10
TC35366	23.50	44.38	9.25	26.00	12

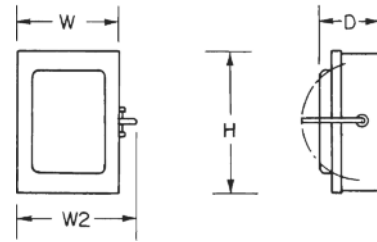

Figure 1

NEMA Type 3R TC Double Throw Approximate Dimensions in Inches Figure 1

Product Number	Dimension W	Dimension H	Dimension D	Dimension W2	KO Figure Number ¹
TC35321R	10.88	19.75	5.33	11.98	No KO
TC35322R	11.88	20.80	6.43	12.98	No KO
TC35323R	14.88	22.91	8.06	16.38	No KO
TC35324R	17.87	30.63	9.15	19.88	No KO
TC35325R	24.40	34.83	10.52	26.94	No KO
TC35362R	11.88	20.80	6.43	12.98	No KO
TC35363R	14.88	22.91	8.06	16.38	No KO
TC35364R	17.87	30.63	9.15	19.88	No KO

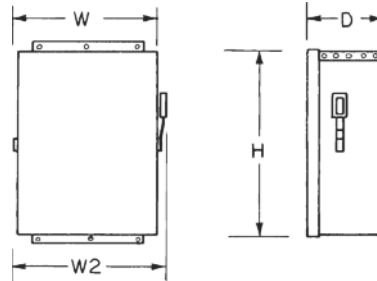

Figure 2

NEMA Type 1 TDT Fusible Double Throw Approximate Dimensions in Inches Figure 5

Product Number	Dimension W	Dimension H	Dimension D	Dimension W2	KO Figure Number ¹
TDT3321	-	37	9 7/8	12 3/4	No KO
TDT3322	-	37	9 7/8	12 3/4	No KO
TDT3323	-	37	9 7/8	12 3/4	No KO
TDT3324	-	51 3/8	11 1/4	20 3/8	No KO
TDT3325	-	74 3/4	14 1/8	26 1/8	No KO
TDT3326	-	86 1/8	14 1/8	28 1/4	No KO
TDT3361	-	37	9 7/8	12 3/4	No KO
TDT3362	-	37	9 7/8	12 3/4	No KO
TDT3363	-	37	9 7/8	12 3/4	No KO
TDT3364	-	51 3/8	11 1/4	20 3/8	No KO
TDT3365	-	74 3/4	14 1/8	26 1/8	No KO

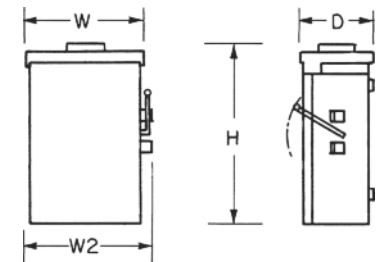

Figure 3

NEMA Type 1 TC 800 and 1200 Amp Approximate Dimensions in Inches Figure 2

Product Number	Dimension W	Dimension H	Dimension D	Dimension W2	KO Figure Number ¹
TC36367	32 1/4	52 1/2	12 1/2	34	No KO
TC36368	37 1/2	65 1/2	13 1/2	39 1/4	No KO
TC72267	41 3/4	62	12 1/2	43 1/2	No KO
TC72268	47 1/2	77	13 1/2	49 1/4	No KO
TC72367	41 3/4	62	12 1/2	43 1/2	No KO
TC72368	47 1/2	77	13 1/2	49 1/4	No KO

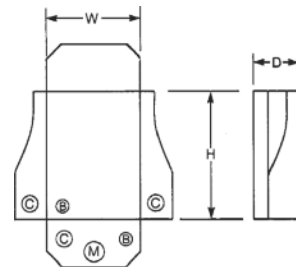

Figure 4

NEMA Type 3R TC Double Throw Approximate Dimensions in Inches Figure 3

Product Number	Dimension W	Dimension H	Dimension D	Dimension W2	KO Figure Number ¹
TC10323R	7 3/8	15 1/8	4	8 1/16	15
TC10324R	13 9/16	30	6 1/4	15 5/8	13
TC10424R	13 9/16	30	6 1/4	15 5/8	13

NEMA Type 3R TDT Fusible Double Throw Approximate Dimensions in Inches Figure 5

Product Number	Dimension W	Dimension H	Dimension D	Dimension W2	KO Figure Number ¹
TDT3321R	-	37	9 7/8	12 3/4	No KO
TDT3322R	-	37	9 7/8	12 3/4	No KO
TDT3323R	-	37	9 7/8	12 3/4	No KO
TDT3324R	-	51 3/8	11 1/4	20 3/8	No KO
TDT3363R	-	37	9 7/8	12 3/4	No KO
TDT3364R	-	51 3/8	11 1/4	20 3/8	No KO

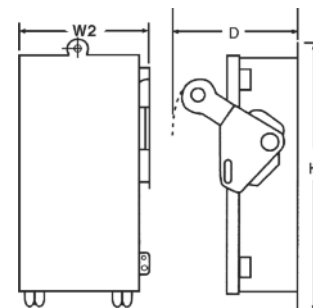

Figure 5

¹See page 3-38.



Safety Switches Enclosure Dimensions

Spec-Setter™ Safety Switches
TC, TDT, TPF and TPN
NEMA Type 1 and 3R Enclosures

Section 4

NEMA Type 3R TC 800 and 1200 Amp Approximate Dimensions in Inches Figure 2

Product Number	Dimension W	Dimension H	Dimension D	Dimension W2	KO Figure Number
TC72267R	41 3/4	62	12 1/2	43 1/2	No KO
TC72268R	47 1/2	77	13 1/2	49 1/4	No KO
TC72367R	41 3/4	62	12 1/2	43 1/2	No KO
TC72368R	47 1/2	77	13 1/2	49 1/4	No KO

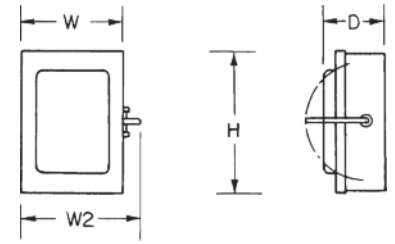

Figure 1

NEMA Type 3R TP AC Disconnect Approximate Dimensions in Inches Figure 4

Product Number	Dimension W	Dimension H	Dimension D	Dimension W2	KO Figure Number ¹
TPF30R	5 3/4	8	3 1/8	-	5
TPF60R	5 3/4	8	3 1/8	-	5
TPN60R1	5	7 1/4	2 1/8	-	5
TPNA60R1	5	7 1/4	2 1/8	-	5

¹See page 4-38.

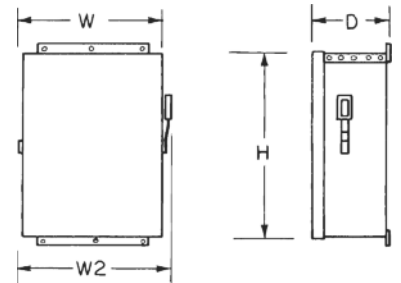

Figure 2

NEMA Type 3R TF AC Disconnect Approximate Dimensions in Inches Figure 5

Product Number	Dimension W	Dimension H	Dimension D	Dimension W2	KO Figure Number ¹
TF30R	4 3/4	7 1/2	2	-	16
TF60R	6 1/2	9	3 1/4	-	16
TFN60R	4 3/4	7 1/2	2	-	16
TFN60RGFR	5 3/4	7 1/8	5 3/16	-	16

¹See page 4-38.

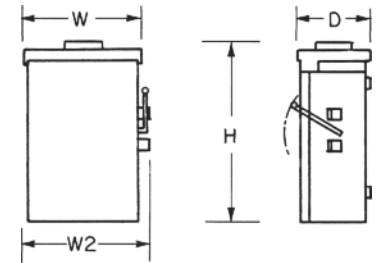

Figure 3

NEMA Type 3R TN AC Disconnect Approximate Dimensions in Inches Figure 5

Product Number	Dimension W	Dimension H	Dimension D	Dimension W2	KO Figure Number ¹
TNA60R1	4 3/4	7 1/2	2	-	16
TNA60RGFR	5 3/4	7 1/8	5 3/16	-	16

¹See page 4-38.

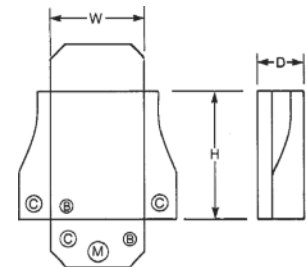

Figure 4

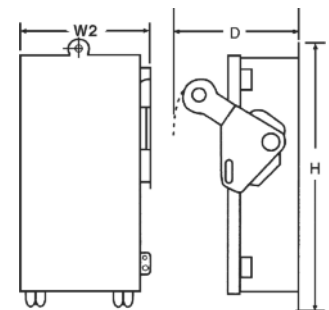

Figure 5



Safety Switches Knockouts

Spec-Setter™ Safety Switches
TC, TDT, TPF and TPN
NEMA Type 1 and 3R Enclosures

Dimensions—Knockouts

Symbol	A	B	C	D	E	F	G	H	J	K	L	M	N
Conduit Size (Inches)	1/2	1/2	3/4	1/2	3/4	1	1 1/4	2	2 1/2	2	3	1	3/4
	—	3/4	1	3/4	1	1 1/4	1 1/2	2 1/2	3	2 1/2	3 1/2	1 1/4	—
	—	—	—	1	1 1/4	1 1/2	2	—	—	3	—	—	—

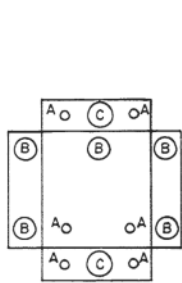

Figure 6

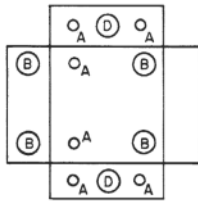

Figure 7

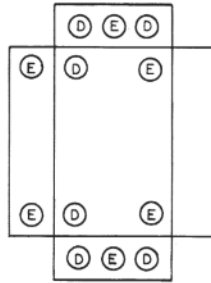

Figure 8

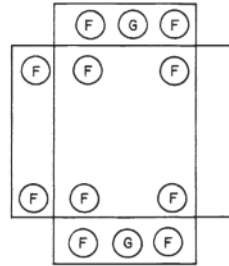

Figure 9

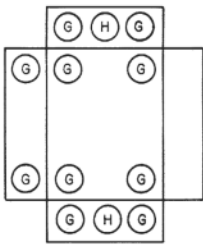

Figure 10

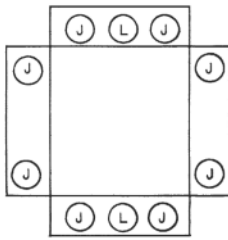

Figure 11

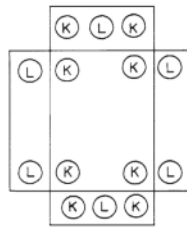

Figure 12

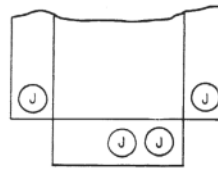

Figure 13

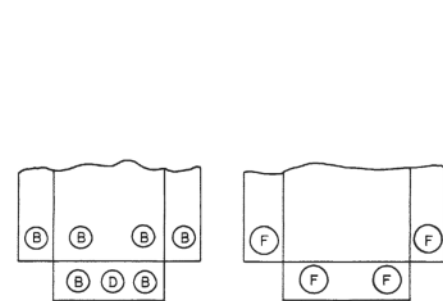

Figure 14

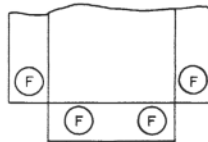

Figure 15

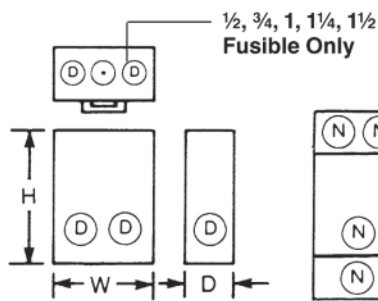

Figure 16



Figure 17

