



## Table of Contents

.....

Finishes and Materials .....	A2
Channels and Concrete Inserts .....	A3–A7
Threaded Products and Hardware .....	A8–A12
Fittings and Brackets .....	A13–A23
Beam Clamps .....	A24–A32
Pipe Straps, Pipe Clamps and Hangers .....	A33–A46
Hanger Accessories .....	A47
Surface Raceway and Lighting Systems .....	A48–A54
Right Angle Slotted Metal Framing .....	A55–A56
Engineering Data & Specifications .....	A57–A73

## Finishes and Materials

### Finishes on Steel

#### Bare (Suffix BC)

#### Pregalvanized (Suffix PGC)

A zinc coating is applied to the steel coil at the mill prior to fabrication. Once the material is worked by roll-forming, cutting, or punching, minimal protection is provided for raw edges. This weakness is typical with precoated material and affects the channel section around holes, extreme ends, and the edges of the U-shape lips. Superstrut® pregalvanized material is in conformance with ASTM A-525/G-90 specification standards, representing 0.90 oz. of zinc per square foot of steel. This finish is often referred to as “mill galvanized.”

#### Electrogalvanized (Suffix EGC)

Often referred to as “zinc plated” or “electroplated zinc,” the steel and 0.5 mils of zinc are bonded by an electrolysis process. Electrogalvanizing is most commonly applied to small fittings, hardware, and threaded products.

#### GoldGalv® (No Suffix)

Gold coloured zinc dichromate is applied over the zinc, producing a chemically bonded non porous barrier for protection from moisture and air. This extends the protective life of the zinc, and provides an excellent base for paint, if desired. The GoldGalv® hardware finish also provides a low electrical resistance when grounding of the system is required. Superstrut® channel and fittings are plated after fabrication, so there are no unprotected edges from cutting or punching. Where field cutting is necessary or scratches occur due to construction handling, you still have the sacrificial protection of the plated zinc to minimize the corrosion of raw edges and prevent spreading.

#### Hot-Dipped Galvanized (Suffix HDGC)

The material is zinc coated after fabrication providing total product protection on all surfaces. The fabricated channel or fitting is suspended and then dipped into tanks of hot zinc for a prolonged period, creating a coherent bond. The result is superior corrosion resistance as compared to pregalvanized material. Hot-dipped galvanizing is not recommended for threaded products, considering the zinc coating thickness will often disrupt the threads. Superstrut® hot-dipped galvanized is in conformance with ASTM Specifications A-123 (formerly A-386) and A-153. Superstrut channels maintain a minimum 1.5 oz. of zinc per square foot of steel or 2.5 mils (ASTM A-123, Thickness Grade 65). This finish is also referred to as “Hot-dipped galvanized after fabrication”.

#### Epoxy Powder Coated — Green, Grey or White (Suffix GR, GY or WH)

Epoxy powder resins are applied electrostatically to the steel after fabrication. Once the material is completely covered with the powder-form epoxy, it proceeds through a 400°F (204°C) baking process for ten minutes, creating a chemical bond. This results in a minimum of 1.5 mil thickness of epoxy coating providing excellent resistance to chipping or peeling.

### Special Materials

#### Aluminum (Suffix ALC)

Superstrut® channel is available in aluminum. Fittings in HDG finish or fiberglass material are suggested for fastening products.

#### Stainless Steel (Suffix SS)

Superstrut® channel is supplied in Type 316 (T316L) stainless steel. All fittings and accessories are in 316SS (SS6). Contact your Regional Sales Office for availability.

**Thomas & Betts reserves the right to change material and finish specifications without notice, to improve its products.**

Bare (suffix BC) is available upon request.

## Channels and Concrete Inserts

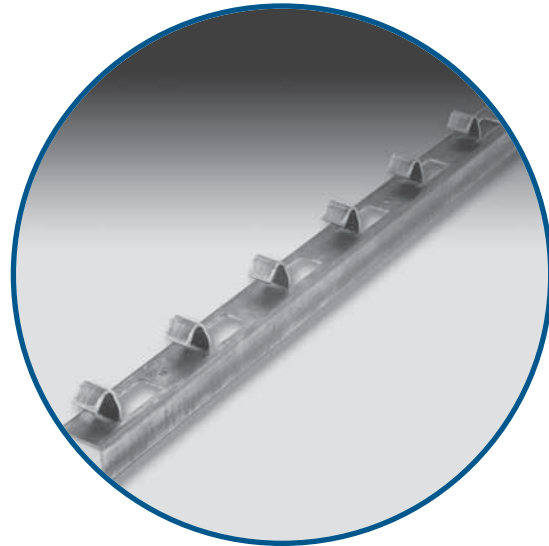
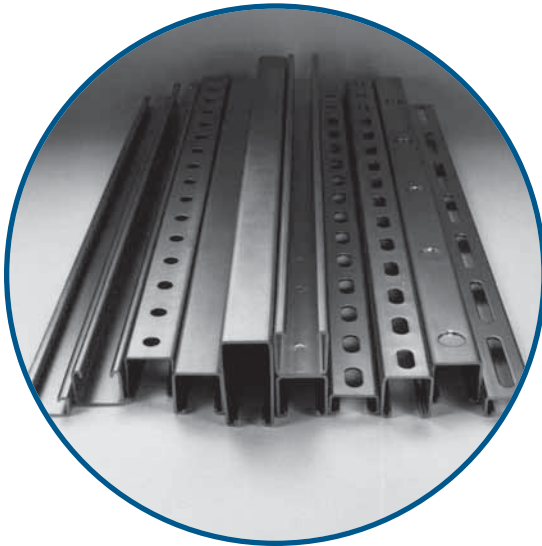

### Channels

#### Material

Steel channels are cold-roll formed from strip steel. Aluminum and Fiberglass channels are extruded profiles.

#### Material Thickness

- All Series 1200** 12 gauge material
- All Series 1400** 14 gauge material
- All Series 1600** 16 gauge ribbed material

#### Standard Lengths

Standard lengths for channels are 10 ft. and 20 ft. with a tolerance of +1/8 in. Special lengths can be requested; however, minimum quantities may apply. Channels are sold per foot.

#### Warning

**Load tables, charts, and design criteria provided in this catalogue are intended as guides only. Selection of proper product, support spacing, erection, and placement are the responsibility of the user.**

**When improperly used as tools of erection, pipe hanger products have occasionally failed. To avoid an accident, the user is cautioned to use the product only as it was intended.**

### Concrete Inserts

#### Material

Superstrut continuous insert channel is manufactured from 12 gauge hot rolled strip steel in two basic sizes as follows:

#### **Cat. No. A302**

1-5/8 in. x 1-5/8 in. 7/8 in. slot

#### **Cat. No. C302**

1-5/8 in. x 1-3/8 in. 7/8 in. slot

#### Standard Lengths

Standard lengths are 10 ft. and 20 ft. Product is supplied with foam filler and end caps to prevent concrete from seeping into channel.

#### Application

For casting into concrete walls, floors or ceilings to provide for attachment anywhere along the continuous slot.

#### Design Data

Load ratings as shown have a safety factor of 3 in 3000 lb. hard rock concrete. Where sound concrete does not exist, the load ratings shall not apply.

GoldGalv® hardware finish is standard for all Superstrut Concrete insert products. This is a multi-process finish of electro-plated zinc, followed by gold coloured zinc dichromate to give excellent corrosion resistance and a superior paint base.

For more information on load design, see page A57 for Engineering Data and Specifications.

**Channels and Concrete Inserts**

**Channels at Full Scale**  
Available in 10 and 20 foot length

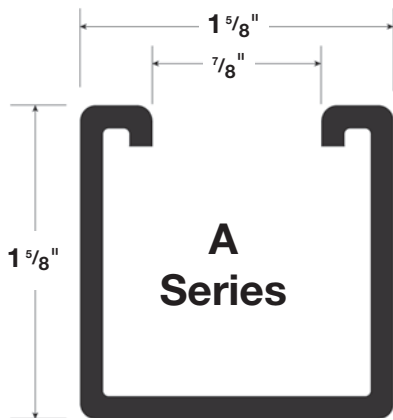

**A Series**  
A1200 12 gauge  
A1400 14 gauge

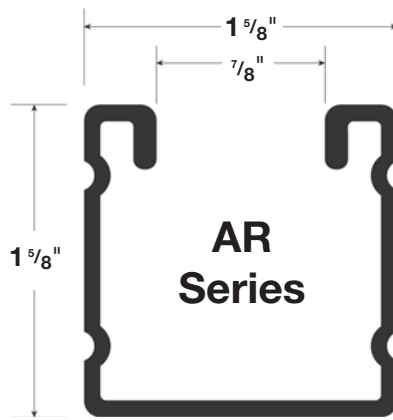

**AR Series**  
16 gauge only

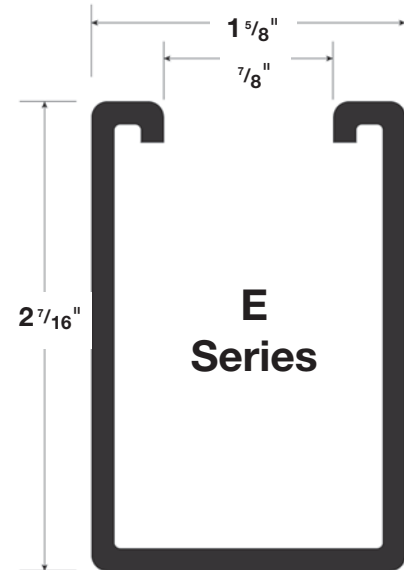

**E Series**  
E1200 12 gauge

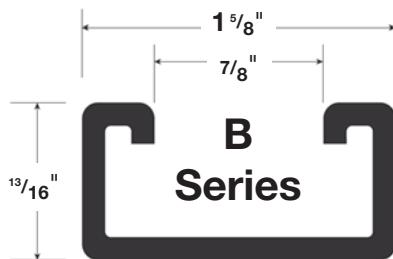

**B Series**  
B1200 12 gauge  
B1400 14 gauge

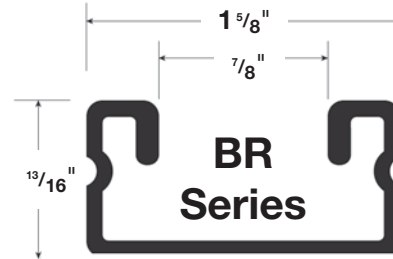

**BR Series**  
16 gauge only

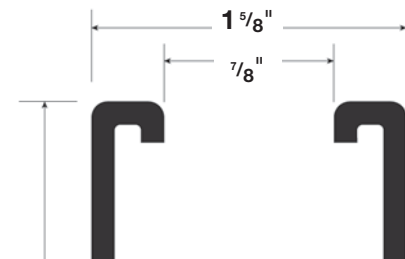

**H Series**  
H1200 12 gauge

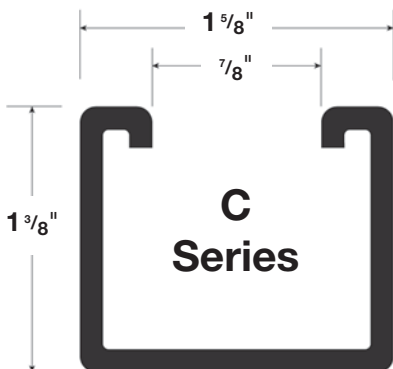

**C Series**  
C1200 12 gauge

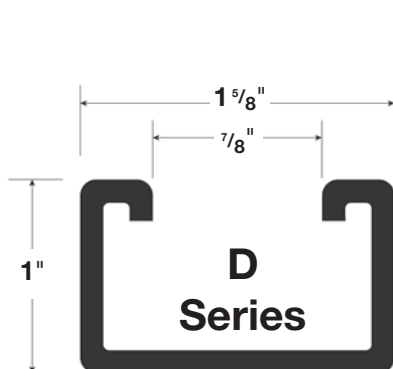

**D Series**  
D1200 12 gauge

## Channels and Concrete Inserts

### Channel Selection Chart

CHANNEL	HOLE CONFIGURATIONS					LENGTH	FINISH ON STEEL					SPECIAL MATERIALS					
	Series	HS	S	SW	P		KO	ft.	BC	PG(C)	EG(C)	GoldGalv®	HDG(C)	GR,GY,WH	PV(C)	AL(C)	T316L
A1200						10 or 20											
A1400						10 or 20											
AR1600						10 or 20											
B1200						10 or 20											
B1400						10 or 20											
BR1600						10 or 20											
C1200						10 or 20											
D1200						10 or 20											
E1200						10 or 20											
H1200						10 or 20											

### Legend

EXAMPLES	HOLE CONFIGURATION		FINISH ON STEEL		SPECIAL MATERIALS	
<b>A120010PG</b> Plain channel, 10 ft., pre- galvanized finish	Suffix		Suffix		Suffix	
	blank	Plain, no holes	BC	Bare	AL	Aluminum
	HS	Half slot	PGC	Pre-galvanized	SS6 (C)	Stainless Steel Type 316
	S	Slotted	EGC	Electrogalvanized	T316L	Stainless Steel Type 316L
<b>B1400P10</b> Punched channel, 10 ft., GoldGalv® finish	SW	Slotted wide	Blank	GoldGalv®		
	P	Punched	HDGC	Hot dipped galvanized		
<b>E1200HS20HDG</b> Half slot channel, 20 ft. hot dipped galvanized	KO	Knockout	GR,GY,WH	Epoxy paint in green (GR), grey (GY), or white (WH)		
		Standard offering		A minimum order quantity may apply		

### Hole Configuration

Half Slot Channel

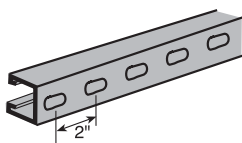

Slots: 9/16 in. X 1-1/8 in.

Slotted Channel

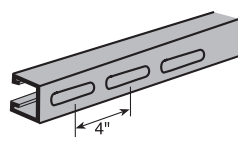

Slots: 7/16 in. X 3 in.

SW "Slotted Wide" Channel

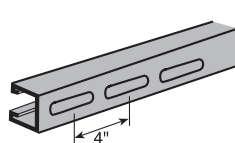

Slots: 9/16 in. X 3 in.

Punched Channel

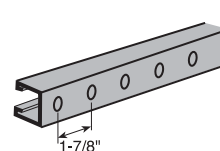

Holes: 9/16 in.

Channel with Knockouts

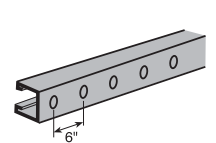

KO: 1/2 in.

## Channels and Concrete Inserts

### Welded Combinations

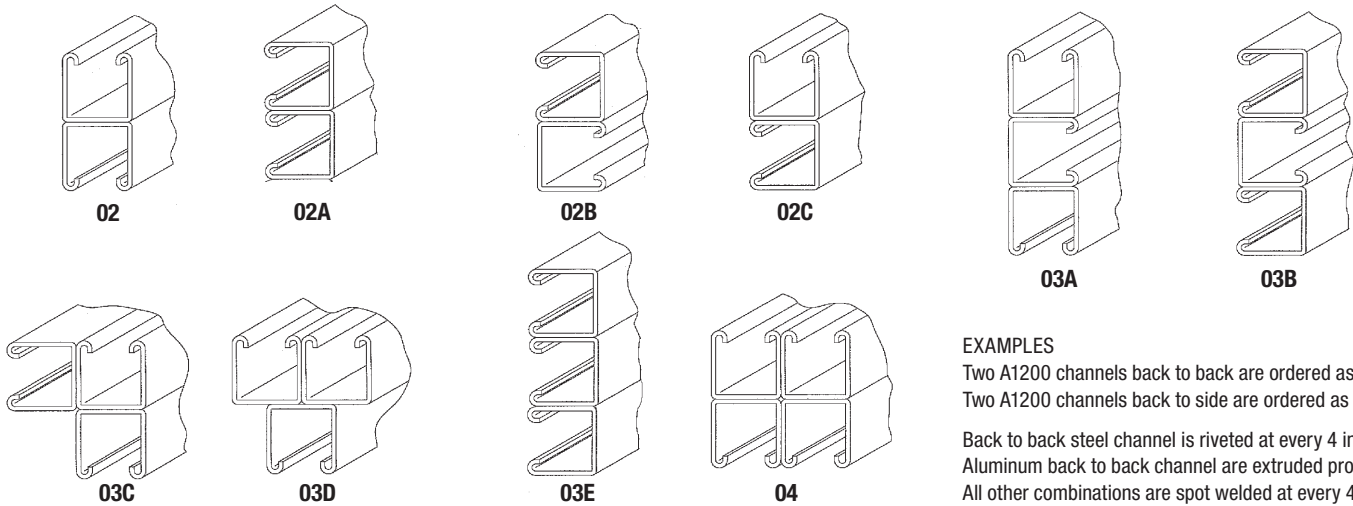

#### EXAMPLES

Two A1200 channels back to back are ordered as A1202.  
Two A1200 channels back to side are ordered as A1202C.

Back to back steel channel is riveted at every 4 inches.  
Aluminum back to back channel are extruded profiles.  
All other combinations are spot welded at every 4 inches.

### End Caps and Closure Strips

#### A804 End Cap

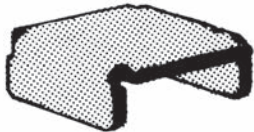

Cat. No.	For Channel	Wt./C lb.
<b>A804EG</b>	A1200	10
	A1400 AR1600	10
<b>B804EG</b>	B1400 BR1600	5
<b>C804EG</b>	C1200	8
<b>E804EG</b>	E1200	15
<b>H804</b>	H1200	20

#### Safety End Cap

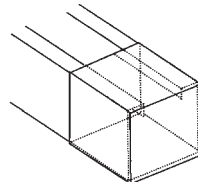

1-5/8 in. x 1-5/8 in. White Plasticsol

Cat. No.	For Channel	Wt./C lb.
<b>A804NEOPWH</b>	A1200 AR1600	1.75
	A1400	
<b>B804NEOPWH</b>	B1200 BR1600	5
<b>H804NEOPWH</b>	H1200	2

#### A243-1EGC End Cap



For A1200 Channel

Wt./C 16 lb.

#### A208

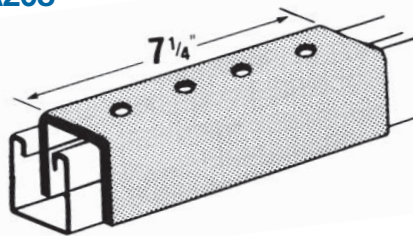

**A208HDGC**  
**A208EG**

Does not include stud nut or bolts.

**A208**  
**A208SS6C**

For A and AR Series channel. Wt./C 275 lb.

#### A213 Inside Joiner

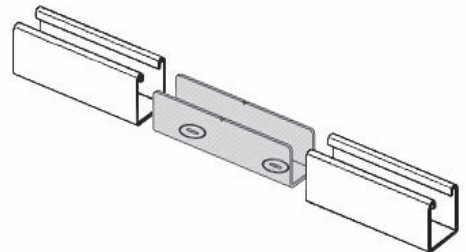

For A1200 Series only.  
Available only in GoldGalv® finish.

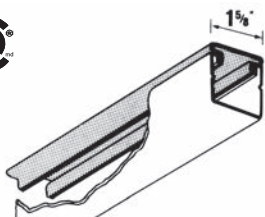

**AB844PGC**  
Pre-Galvanized  
Closure Strip

**AB844PCGY**  
Plastic Closure Strip  
Colour: Grey

**AB844PC**  
Plastic Closure Strip  
Colour: Gold

For all channel. Standard lengths 10 ft.

## Channels and Concrete Inserts

### Concrete inserts

#### Concrete Channel Inserts

**\*Finishes**

- HDGC
- GoldGalv®
- PGC

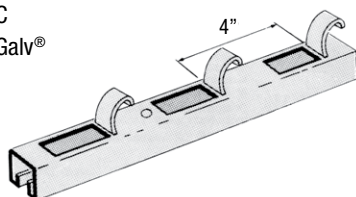

Insert with end caps and foam closure strip installed.

Cat. No.	Length (ft.)	Gauge	Wt. (lb./ft.)
A302-10*	10	12	2.19
A302-20*	20		2.19
B302-10*	10		1.36
B302-20*	20		1.36

Design Load 2000 lb. per foot in hard rock concrete with a safety factor of 3.

Standard lengths: 10 ft. and 20 ft.

Length tolerance: 3/16 in.

#### Anchor Caps

**\*Finishes**

- EGC
- GoldGalv®

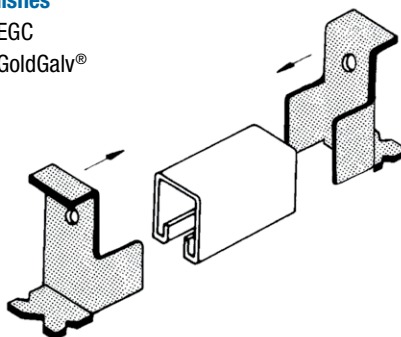

12 gauge, Wt./C: 30 lb./C

A450\* For A Series

C450\* For C Series

From pieces of A, B, C channel and a pair of anchor caps, short concrete inserts can be fabricated in the field.

#### 460-10TB Removable Plastic Closure Strip

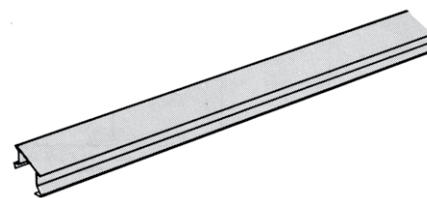

Designed as an added precaution to keep insert free of concrete. Closure strip fits all 1-5/8 in. wide strip inserts, regardless of depth.

Order per 10 foot, standard length is 10 ft.

Material – Black Plastic

Wt./C 52 lb.

#### SI400 Spot Insert Kit

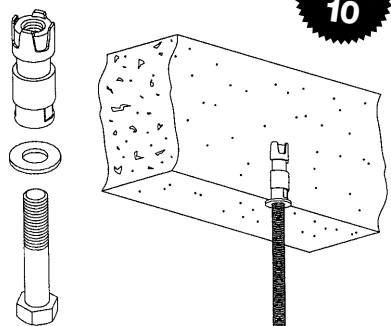

Cat. No.	Thred size	O.D. Insert	Wt./C lb.
SI400-3/8	3/8 – 16	2x5/8	10
SI400-1/2	1/2x13x1-1/4	2-1/2x7/8	35

Other sizes available.

Maximum recommended load:

SI400-3/8 = 450 lb./204 kg

SI400-1/2 = 1000 lb./454 kg

#### 452TB Spot Insert

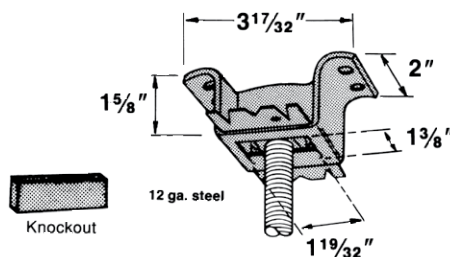

**Standard Finish – GoldGalv®**

An insert with a knockout saves covering the opening. Accommodates hanger rod sizes from 1/4 in. through 7/8 in. by means of an AB102 insert nut, to be ordered separately.

**Design load:** 1350 lb. in 3000 lb. hard rock concrete with a safety factor of 3.

Complies with Specification MSS SP69, Type 18.

## Threaded Products and Hardware

### Channel Nuts

Superstrut® channel nuts are manufactured from Grade 2 mild steel and are case hardened.

### Design Data

Superstrut® self aligning channel nuts are designed to provide resistance to pullout and resistance to side slip in excess of the full strength of the channels with which they are used. The extreme resistance to side slip results from the unique design of the alternate teeth, spaced and designed to develop a wedging action that increases with pressure or load.

### Screw Threads

All threaded products are American Standard thread, free fit class 2.

Thread Size	1/4	5/16	3/8	1/2	5/8	3/4	7/8	1
Threads per inch	20	18	16	13	11	10	9	8
Design Torque (ft.-lb.)	6	11	19	50	100	125	185	275

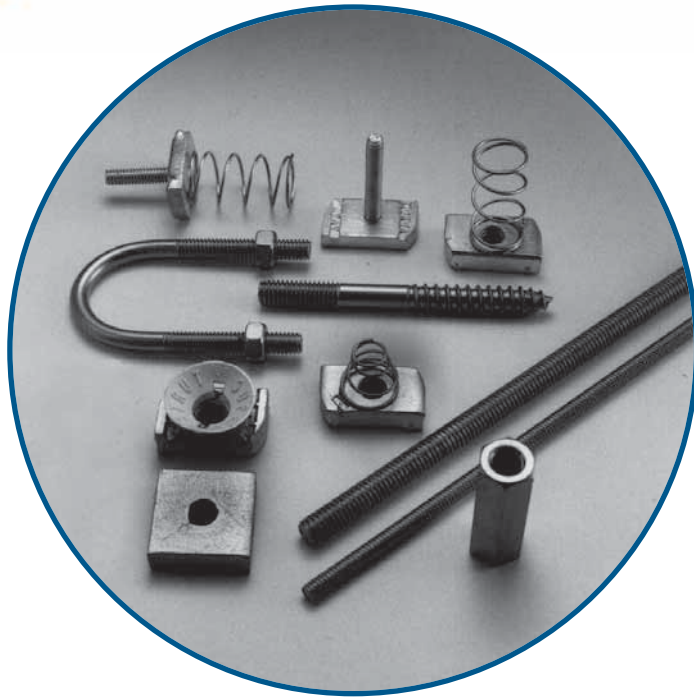

### Spring Nut Selector Chart

SPRING NUT	CHANNEL SERIES					
	A - AR	B - BR	C	D	E	H
A100-1/4EGC	■		■			
A100-5/16EGC	■		■			
A100-3/8EGC	■		■			
A100-1/2EGC	■		■			
A100-3/4	■		■			
B100-1/4EGC		■		■		
B100-5/16EGC		■		■		
B100-3/8EGC		■		■		
B100-1/2EGC		■		■		
H100-3/8EGC					■	■
H100-1/2EGC					■	■
CM100-1/4	■		■		■	■
CM100-3/8	■		■		■	■
CM100-1/2	■		■		■	■
CM100-1/2B		■				
UC100-1/4	■		■		■	■
UC100-3/8	■		■		■	■
UC100-1/2	■		■		■	■

### Finish and special materials

Standard finish for all hardware is Electrogalvanized (EGC) or GoldGalv®. Stainless Steel Type 316 is also available. Contact your Regional Sales Office for availability and minimum quantities.



## Threaded Products and Hardware

### A100 Regular Spring Nut\*

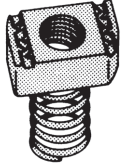

Available in Stainless Steel 316. Nut is square over 1/2 in. size. For all A and C Series channel and inserts.

Cat. No.	Size (in.)	Wt./C lb.
A100-1/4EGC	1/4	8
A100-5/16EGC	5/16	9
A100-3/8EGC	3/8	10
A100-1/2EGC	1/2	12
A100-5/8EGC	5/8	19
A100-3/4	3/4	19
A100-7/8	7/8	18

STD. PACK 100

### B100 Short Spring Nut\*



Cat. No.	Size (in.)	Wt./C lb.
B100-1/4EGC	1/4	7
B100-5/16EGC	5/16	8
B100-3/8EGC	3/8	9
B100-1/2EGC	1/2	9

STD. PACK 100

For all B and D Series channel and inserts.

### H100 Long Spring Nut\*

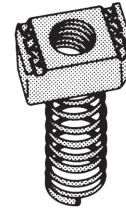

Cat. No.	Size (in.)	Wt./C lb.
H100-3/8EGC	3/8	10
H100-1/2EGC	1/2	14

STD. PACK 100

For all E and H Series channel and inserts.

### AB100 Springless Nut 1/4 in. thick



For use with all channels. Nut is square over 1/2 in. size.

Cat. No.	Size (in.)	Wt./C lb.
AB100-1/4EGC	1/4	7
AB100-5/16EGC	5/16	8
AB100-3/8EGC	3/8	9
AB100-1/2EGC	1/2	9
AB100-5/8EGC	5/8	10
AB100-3/4EGC	3/4	10

STD. PACK 100

### AC100 Springless Nut Heavy duty 3/8 in. thick



Cat. No.	Size (in.)	Wt./C lb.
AC100-3/8EGC	3/8	9
AC100-1/2EGC	1/2	11
AC100-5/8EGC	5/8	18
AC100-3/4EGC	3/4	18

STD. PACK 100

For all A, C, E and H Series channel and inserts. Nut is square over 1/2 in. size.

### 813EG Springless Nut Light Duty

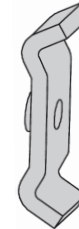

Cat. No.	Size (in.)	Wt./C lb.
813EG	1/4	5

STD. PACK 100

For use with all channels.

### A182 to A185 Regular Spring Stud Nut\*

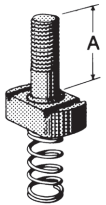

For all A and C Series channels.

Cat. No.	Bolt Dia (in.)	Length A (in.)	Wt./C lb.
A182-1/4x100EG	1/4	1	10
A182-1/4x125EG	1/4	1-1/4	15
A184-3/8x100EG	3/8	1	10
A184-3/8x125EG	3/8	1-1/4	15
A185-1/2x100EG	1/2	1	10
A185-1/2x125EG	1/2	1-1/4	15

STD. PACK 100

### A177 to A179 Springless Stud Nut

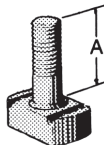

Cat. No.	Bolt Dia (in.)	Length A (in.)	Wt./C lb.
A177-1/4x100EG	1/4	1	8
A177-1/4x125EG	1/4	1-1/4	10
A179-3/8x100EG	3/8	1	13
A179-3/8x125EG	3/8	1-1/4	13.5

STD. PACK 100

For use with all channels.

### 812 Stud Nut

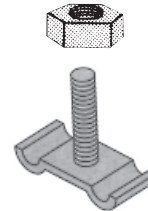

Cat. No.	For Channel	Wt./C lb.
812-1EG	1/4 x 1	6

STD. PACK 100

For attaching fixture to channel slot down or to channel slot up knockouts. Specify length. Hex nut included.

### E145 Standard Hex Nut



Cat. No.	Size (in.)	Wt./C lb.
E145-1/4EGC	1/4	.72
E145-3/8EGC	3/8	1.60
E145-1/2EGC	1/2	2.78
E145-5/8EGC	5/8	6.92
E145-3/4EGC	3/4	12.70
E145-7/8EGC	7/8	19.00
E145-1EGC	1	28.00

STD. PACK 100

### UCN Universal Nylon Cone Nut

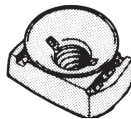

Cat. No.	Size (in.)	Wt./C lb.
UCN-1/4	1/4	8
UCN-3/8	3/8	10
UCN-1/2	1/2	12

STD. PACK 100

GoldGalv® only  
For all 1-5/8 in. and 1-1/2 in. channels.  
May be used with ALL Strut Depths.  
Can be used for A100 Series, B100 Series and AB100 Series.

### AB102 Unhardened Square Nut

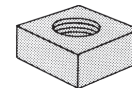

Cat. No.	Size (in.)	Wt./C lb.
AB102-1/4	1/4	13
AB102-3/8	3/8	14
AB102-1/2	1/2	14
AB102-5/8	5/8	12
AB102-3/4	3/4	11
AB102-7/8	7/8	10

STD. PACK 100

### ES145 Swivel Nut and Jam Nut Combinations

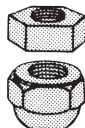

Cat. No.	Size (in.)	Wt./C lb.
ES145-3/8	3/8	5.5
ES145-1/2	1/2	6.0

STD. PACK 100

### E146 Standard Square Nut



Cat. No.	Size (in.)	Wt./C lb.
E146-1/4EGC	1/4	.93
E146-5/16EGC	5/16	1.60
E146-3/8EGC	3/8	2.65
E146-1/2EGC	1/2	5.83
E146-5/8EGC	5/8	10.80

STD. PACK 100

\*Supplied with a plastic sleeve over the spring portion to prevent tangling inside the carton.

## Threaded Products and Hardware

### E147 Flat Steel Washer

STD. PACK: 100

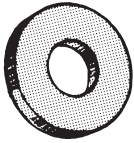

Cat. No.	Size (in.)	Wt./C lb.
E147-1/4EG	1/4	0.67
E147-5/16EG	5/16	1.11
E147-3/8EG	3/8	1.49
E147-1/2EG	1/2	3.85
E147-5/8EG	5/8	7.69
E147-3/4EG	3/4	9.89
E147-7/8EG	7/8	15.40

Available in Stainless Steel.

### EF147 Fender Washer

STD. PACK: 100

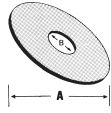

Cat. No.	Size (in.)	A (in.)	B (in.)	Wt./C lb.
EF147-1/4EGC	1/4	1-1/4	5/16	3.1
EF147-3/8EGC	3/8	1-1/2	7/16	2.9
EF147-1/2EGC	1/2	2	9/16	5.0

Available in Stainless Steel.

### E148 Lock Washer

STD. PACK: 100



Cat. No.	Size (in.)	Wt./C lb.
E148-1/4EG	1/4	0.26
E148-3/8EG	3/8	0.50
E148-1/2EG	1/2	1.09
E148-5/8EG	5/8	2.57

Available in Stainless Steel.

### E142 Hex Head Cap Screw

STD. PACK: 100

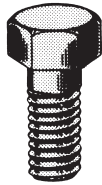

Cat. No.	Size (in.)	Wt./C lb.
E142-1/4x100EG	1/4x1	1.74
E142-1/4x150EG	1/4x1-1/2	2.43
E142-3/8x100EG	3/8x1	4.17
E142-3/8x150EG	3/8x1-1/2	5.64
E142-1/2x100EG	1/2x1	8.94
E142-1/2x150EG	1/2x1-1/2	10.00
E142-1/2x200EG	1/2x2	11.19
E142-1/2x225EG	1/2x2-1/4	11.90
E142-1/2x250EG	1/2x2-1/2	12.52
E142-1/2x275EG	1/2x2-3/4	13.22

Available in Stainless Steel.

### E150S Lag Bolt

STD. PACK: 50



Cat. No.	Drill Size (in.)	Size (in.)	Wt./C lb.
E150S-3/8x1-1/2EG	1/4	3/8x1-1/2	5
E150S-3/8x2EG	1/4	3/8x2	7
E150S-3/8x2-1/2EG	1/4	3/8x2-1/2	8
E150S-3/8x3EG	1/4	3/8x3	9
E150S-1/2x1-1/2EG	11/32	1/2x1-1/2	12
E150S-1/2x2EG	11/32	1/2x2	13
E150S-1/2x2-1/2EG	11/32	1/2x2-1/2	15
E150S-1/2x3EG	11/32	1/2x3	18

### E151 Coach Screw Rod



Cat. No.	Rod Size (in.)	Std Rod Lengths (in.)	Wt./C lb.
E151-3/8x4EG	3/8	4	9
E151-3/8x6EG	3/8	6	14
E151-3/8x8EG	3/8	8	22
E151-3/8x10EG	3/8	10	29
E151-3/8x12EG	3/8	12	35
E151-1/2x4EG	1/2	4	17
E151-1/2x6EG	1/2	6	22
E151-1/2x8EG	1/2	8	40
E151-1/2x10EG	1/2	10	51

Machine threaded opposite end, carbon steel.

### H104 Hanger Rod Continuous Threaded



STD. PACK: 3

Cat. No.	Thread Size (in.)	Wt./lb. 100 ft.	Design Load lb.
H104-1/4x10EGC	1/4	12.5	150
H104-3/8x10EGC	3/8	29	610
H104-1/2x10EGC	1/2	53.5	1130
H104-5/8x10EGC	5/8	85	1810
H104-3/4x10EGC	3/4	123	2710
H104-7/8x10EG	7/8	130	3770
H104-1x10EG	1	214	4960

- Black available upon request
- Sold per foot; standard length, 10 ft.
- Also available in stainless steel (316) standard length 6 ft.
- National coarse thread

### H119 Rod Couplings

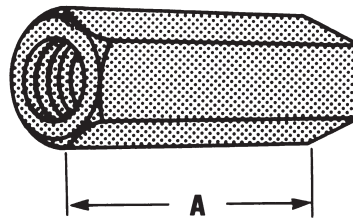

Rod Size	A (in.)	Wt./C lb.
1/4	7/8	1.90
5/16	7/8	3.75
3/8	1-1/8	3.50
1/2	1-1/4	5.50
5/8	2-1/8	18.00
3/4	2-1/4	28.00
7/8	2-1/2	55.00
1	2-1/4	56.00

Standard Rod Coupling  
**Example:** H119-1/2EG

Order by product number, rod size, and finish.  
 Available in Stainless Steel.

Rod Size	A (in.)	Wt./C lb.
1/4 to 3/8	1-1/2	3.50
3/8 to 1/2	1-1/4	6.70
1/2 to 5/8	1-1/4	14.00
5/8 to 3/4	1-1/2	21.00
3/4 to 7/8	1-3/4	40.00

Rod Reducer Coupling  
**Example:** H119-1/4x3/8EG

## Threaded Products and Hardware

### H122 Trapnut™ Strut Fastener



Cat. No.	Size (in.)	Design Load lb.	Std. Ctn.
H 122 1/4	1/4	150	50
H 122 3/8	3/8	590	
H 122 1/2	1/2	1080	
H 122 1/4 EG	1/4	150	
H 122 3/8 EG	3/8	590	
H 122 1/2 EG	1/2	1080	
H 122 1/4 SS6	1/4	150	

Finishes: Electrogalvanized (EG), GoldGalv®, Stainless Steel Type 316 (SS6)



### M117 Eye Socket

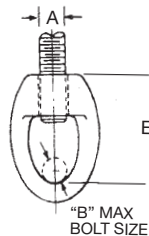
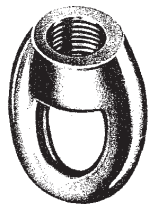

Rod Size A (in.)	Pipe Size (in.)	B (in.)	E (in.)	Wt./C lb.	Design Load, lb.
1/4	3/8	1/4	1-11/32	5	230
3/8	1/2 - 2	1/4	1-11/32	7	610
1/2	2-1/2 - 3-1/2	1/4	1-17/32	13	1130
5/8	4 - 5	3/8	1-13/16	19	1810
3/4	6	1/2	2-5/32	31	2400
7/8	8	1/2	2-11/32	44	2800

#### Standard Finishes - Bare (B), Electrogalvanized (EG)

Malleable iron. For attaching hanger rod to various types of hangers and beam clamps.

Order by product number, rod size, and finish. **Example: M117-1/4B**

Complies with Specification MSS SP69, Type 16.

### E120 Swivel Joint

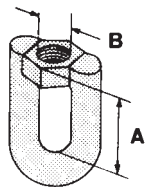

Cat. No.	Size (in.)	A (in.)	B (in.)	Wt./C lb.	Design Load, lb.
E120-3/8	3/8	1-3/8	3/8	15	1000
E120-1/2	1/2	1-1/2	1/2	25	1800

### E120A Weldless Eye Nut

#### Standard Finish - Bare (B)

Drop Forged Steel.

For use on high temperature piping installations.

Order by product number and rod size.

**Example: E120A-3/8B**

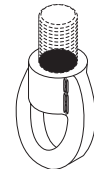

Rod Size T	A (in.)	B (in.)	C (in.)	D (in.)	E (in.)	F (in.)	Wt./C lb.	Design Load, lb.
3/8	7/8	5/8	1-1/4	2	2-1/2	3/8	20	2700
1/2	7/8	5/8	1-1/4	2	2-1/2	3/8	22	2700
5/8	1-3/8	3/4	1-1/2	2-1/2	3	1/2	60	5000
3/4	1-3/8	3/4	1-1/2	2-1/2	3	1/2	56	5000
7/8	1-1/2	1-5/8	1-5/16	3-5/8	4-1/2	3/4	174	10000
1	1-1/2	1-5/8	1-5/16	3-5/8	4-1/2	3/4	168	10000

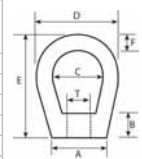

### E122 Swivel Joint

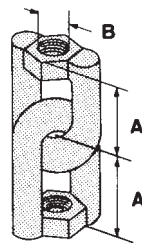

Cat. No.	Size (in.)	A (in.)	B (in.)	Wt./C lb.	Design Load, lb.
E122-3/8	3/8	1-3/8	3/8	28	1000
E122-1/2	1/2	1-1/2	1/2	48	1800

### E130 Swivel Joint

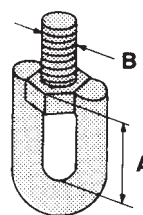

Cat. No.	Size (in.)	A (in.)	B (in.)	Wt./C lb.	Design Load, lb.
E130-3/8	3/8	1-3/8	3/8	23	1000
E130-1/2	1/2	1-1/2	1/2	28	1800

### E131 Swivel Joint

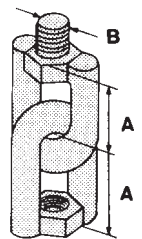

Cat. No.	Size (in.)	A (in.)	B (in.)	Wt./C lb.	Design Load, lb.
E131-3/8	3/8	1-3/8	3/8	25	1000
E131-1/2	1/2	1-1/2	1/2	52	1800

## Threaded Products and Hardware

### C781 Square Washer

STD.  
PACK:  
50

Cat. No.	Rod Size (in.)	Hole Size (in.)	Overall Dimensions (in.)	Wt./C lb.
C781-3/8*	3/8	7/16	3 x 3 x 3/16	27
C781-1/2*	1/2	9/16	3 x 3 x 3/16	27
C781-5/8*	5/8	11/16	3 x 3 x 1/4	47
C781-3/4*	3/4	13/16	3 x 3 x 1/4	42
C781-7/8*	7/8	15/16	4 x 4 x 3/8	85
C781-1*	1	1-1/8	4 x 4 x 3/8	160

#### \*Finishes

- B
- HDG
- EG
- SS6

Used for beam applications.  
For channel applications use AB241.

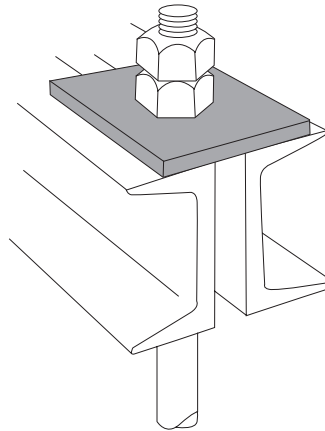

### H115 Standard U-Bolt

Pipe Size (in.)	A (in.)	B (in.)	C (in.)	D (in.)	E (in.)	Wt./C lb.	Design Load, lb.
1/2	15/16	1-3/4	1-1/2	1/4	2-3/4	13	1500
3/4	1-1/8	1-3/4	1-5/8	1/4	3-1/16	15	2000
1	1-3/8	1-7/8	1-5/8	1/4	3-5/16	16	2500
1-1/4	1-23/32	1-3/4	1-15/32	3/8	3-1/2	17	2500
1-1/2	2	1-3/4	1-7/16	3/8	3-3/4	18	2500
2	2-7/16	2-1/16	1-7/8	3/8	4-11/16	32	3300
2-1/2	2-15/16	2-1/16	1-13/16	1/2	5-1/8	34	4000
3	3-9/16	2	1-3/4	1/2	5-11/16	38	4000
3-1/2	4-3/32	2	1-23/32	1/2	6-3/16	40	4000
4	4-19/32	2-1/4	1-31/32	1/2	6-15/16	46	4000
5	5-5/8	3	2-7/32	1/2	8-5/16	101	4000
6	6-3/4	3-3/4	2-13/16	5/8	10-1/8	197	4000
8	8-3/4	3-3/4	2-13/16	5/8	12-1/8	233	4000
10	10-7/8	4	3	3/4	14-9/16	491	5400
12	12-7/8	4-1/4	3-1/4	7/8	16-15/16	773	7500

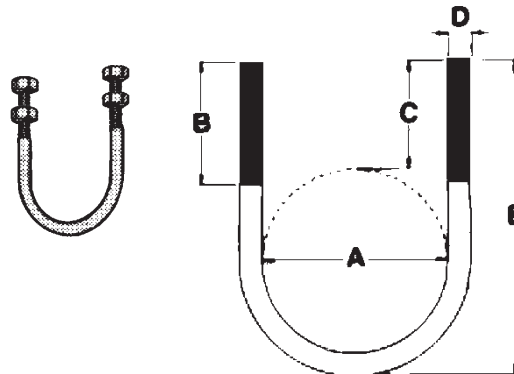

Standard Finishes - Electrogalvanized (EG), GoldGalv®, Stainless Steel or Bare (B)

Example: H115-1/2EG

Sizes through 4 in. furnished with one hex nut per leg.

Sizes 5 in. and above furnished with two hex nuts per leg.

Order by Cat. No., pipe size, finish.

Complies with Specification MSS SP69, Type 24.

## Fittings and Brackets

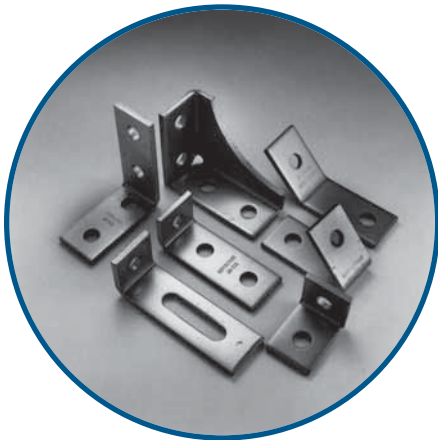

### Material

Superstrut® fittings and brackets are manufactured from hot rolled carbon steel.

### Dimensions

The following standard dimensions apply to all fittings except as indicated on the individual drawings.

<b>Hole spacing</b>	13/16 in. from end of fittings
<b>Hole spacing</b>	1-7/8 in. centers
<b>Hole size</b>	9/16 in. diameter
<b>Material</b>	1-5/8 in. wide
<b>Material</b>	1/4 in. thick

### Application Instructions

Parts drawings illustrate a typical use for the fitting, and in many cases other uses for the part are appropriate.

### Design Data

Load ratings vary depending fittings and brackets are used with 12, \*14 or 16 gauge channel. Ratings are shown for each channel material. (See page A57 for Engineering Data and Specifications).

### Nuts and Bolts Required

Unless otherwise noted, nuts and bolts for use with fittings and brackets should be ordered separately.

The standard bolt for the 9/16 in. hole is a 1/2 in. hex head cap screw 1 in. long. The 1 in. length may be used with all Series channel.

### Design Load

For more information on design load, see page A57 Engineering Data and Specifications.

### Finishes and Special Materials

Standard finishes are Hot Dipped Galvanized (HDGC) and GoldGalv® (no suffix). Fittings are also available in ElectroGalvanized (EG) and Stainless Steel 316 (SS6C). Contact your Regional Sales Office for availability and minimum quantities.

### Aluminum channel

For Aluminum channel, we suggest fittings in HDG (C) or SS6 (C).

## Fittings and Brackets

### Flat Fittings

#### AB206

AB206HDGC  
AB206EG  
AB206  
AB206SS6C  
Wt./C 35 lb.

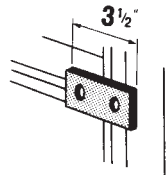

#### AB207

AB207HDGC  
AB207EG  
AB207  
AB207SS6C  
Wt./C 52 lb.

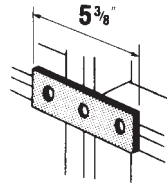

#### X207

X207HDG  
X207EG  
X207  
X207SS6  
Wt./C 78 lb.

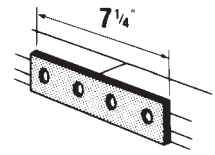

#### X208

X208HDG  
X208EG  
X208  
X208SS6C  
Wt./C 88 lb.

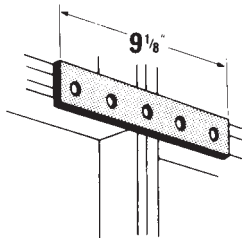

#### AB219

AB219HDGC  
AB219EG  
AB219  
AB219SS6C  
Wt./C 53 lb.

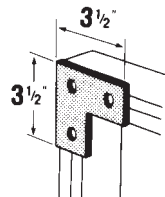

#### AB220

AB220HDGC  
AB220EG  
AB220  
AB220SS6C  
Wt./C 78 lb.

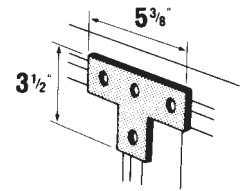

#### AB240

AB240HDG  
AB240EG  
AB240  
Wt./C 69 lb.

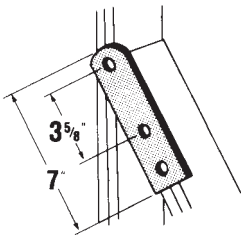

#### AB241

**\*Finishes**

- HDGC
- EG
- GoldGalv®
- SS6C

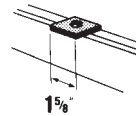

Cat. No.	Bolt Size (in.)	Wt./C lb.
AB241-1/4*	1/4	18
AB241-5/16*	5/16	18
AB241-3/8*	3/8	18
AB241-1/2*	1/2	17
AB241-5/8*	5/8	15
AB241-3/4*	3/4	14

#### AB242

AB242HDGC  
AB242EG  
AB242  
Wt./C 9 lb.

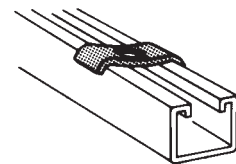

For use with either 3/8 in. or 1/2 in. hanger rod.

#### AB253

AB253HDGC  
AB253EG  
AB253  
AB253SS6C  
Wt./C 97 lb.

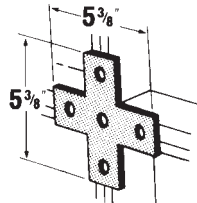

#### AB255

AB255HDGC  
AB255EG  
AB255  
Wt./C 70 lb.

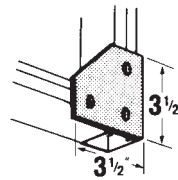

#### AB257

AB257HDGC  
AB257EG  
AB257  
Wt./C 105 lb.

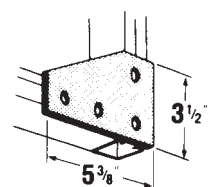

#### AB261

AB261HDGC  
AB261EG  
AB261  
Wt./C 148 lb.

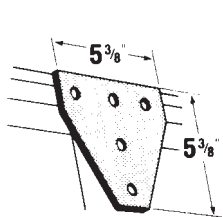

#### AB263

AB263HDGC  
AB263EG  
AB263  
AB263SS6  
Wt./C 150 lb.

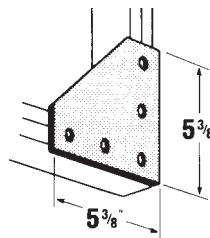

#### AB265

AB265HDGC  
AB265EG  
AB265  
Wt./C 105 lb.

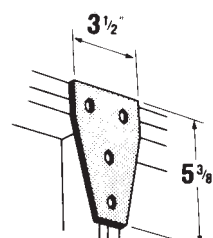

**Standard Dimensions**

Hole Spacing  
Hole Spacing  
Hole Size  
Material  
Material

13/16 in. From End  
1-7/8 in. Centers  
9/16 in. Diam.  
1-5/8 in. Width  
1/4 in. Thick

**Materials**

HDG(C)  
EG(C)  
(No suffix)  
SS6(C)

Hot-Dipped Galvanized  
ElectroGalvanized  
GoldGalv®  
Stainless Steel 316

## Fittings and Brackets

### 90° Fittings

#### AB201

AB201HDGC

AB201EG

AB201

AB201SS6C

Wt./C 35 lb.

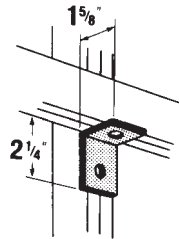

#### AB202

AB202HDGC

AB202EG

AB202

AB202SS6C

Wt./C 35 lb.

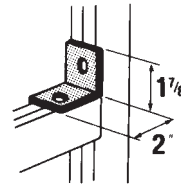

#### AB203

AB203HDGC

AB203EG

AB203

AB203SS6C

Wt./C 58 lb.

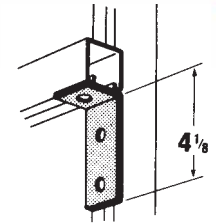

#### AB204

AB204HDGC

AB204EG

AB204

AB204SS6C

Wt./C 58 lb.

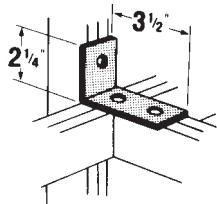

#### AB205

AB205HDGC

AB205EG

AB205

AB205SS6C

Wt./C 78 lb.

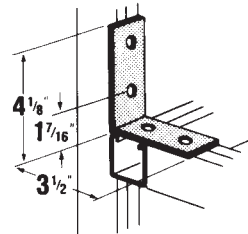

#### AB213

AB213HDGC

AB213EG

AB213

Wt./C 125 lb.

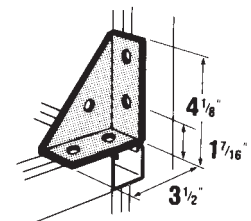

#### AB214

AB214HDGC

AB214EG

AB214

AB214SS6C

Wt./C 125 lb.

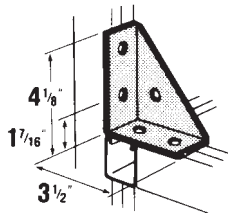

#### AB216

AB216HDGC

AB216EG

AB216SS6C

Wt./C 135 lb.

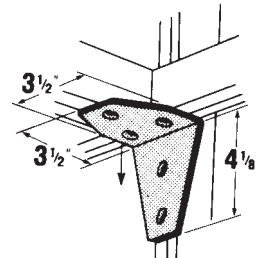

#### AB252

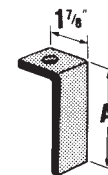

#### \*Finishes

- HDGC
- GoldGalv®
- EG

Cat. No.	A (in.)	Wt./C lb.
AB252-1*	3-7/8	61
AB252-2*	5-7/8	84
AB252-3*	7-7/8	107
AB252-4*	9-7/8	130

#### AB254R

AB254RHDGC

AB254REG

AB254R

Wt./C 105 lb.

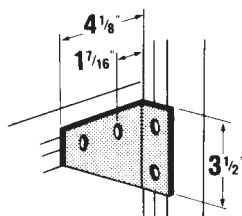

#### AB254L

AB254LHDGC

AB254LEG

AB254L

Wt./C 105 lb.

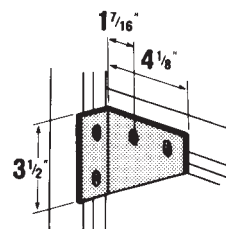

#### AB260R

AB260RHDGC

AB260REG

AB260R

Wt./C 58 lb.

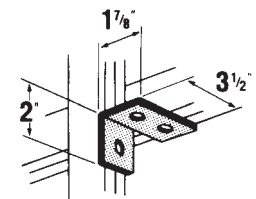

#### AB260L

AB260LHDGC

AB260LEG

AB260L

Wt./C 58 lb.

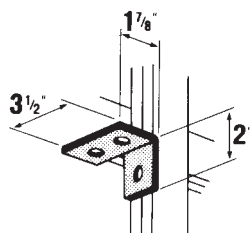

#### AB274

AB274HDG

AB274EG

AB274

Wt./C 70 lb.

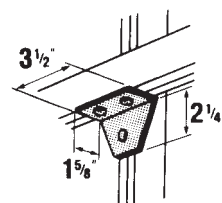

#### AB275

AB275HDGC

AB275EG

AB275SS6C

Wt./C 77 lb.

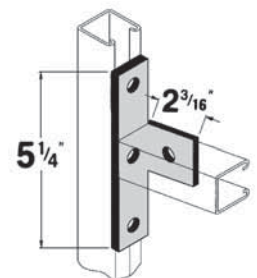

Standard Dimensions

Hole Spacing  
Hole Spacing  
Hole Size  
Material

13/16 in. From End  
1-7/8 in. Centers  
9/16 in. Diam.  
1-5/8 in. Width  
1/4 in. Thick

Materials

HDG(C)  
EG(C)  
(No suffix)  
SS6(C)

Hot-Dipped Galvanized  
Electrogalvanized  
GoldGalv®  
Stainless Steel 316

## Fittings and Brackets

### 90° Fittings

#### AB284R

AB284RHDG  
AB284REG  
AB284R  
Wt./C 230 lb.

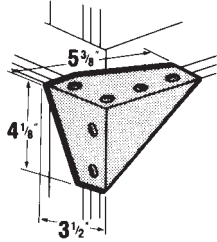

#### AB284L

AB284LHDG  
AB284LEG  
AB284L  
Wt./C 230 lb.

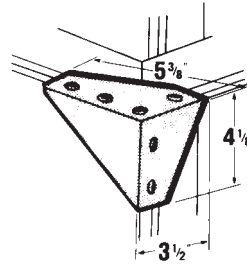

#### AB299

AB299HDG  
AB299EG  
AB299  
Wt./C 40 lb.

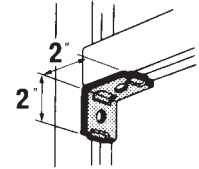

#### X201

X201HDG  
X201EG  
X201  
Wt./C 65 lb.

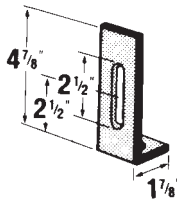

#### X204

X204HDG  
X204EG  
X204  
Wt./C 1-90 lb.

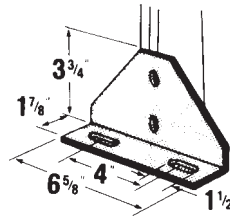

#### X289

X289HDGC  
X289EG  
X289  
Wt./C 105 lb.

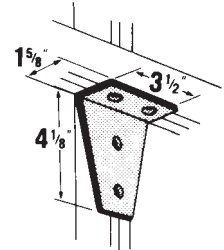

#### X299

X299HDGC  
X299EG  
X299  
Wt./C 38 lb.



#### N205

N205HDGC  
N205EG  
N205  
N205SS6C  
Wt./C 74 lb.

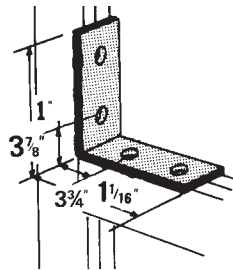

#### N219

N219HDG  
N219EG  
N219  
N219SS6  
Wt./C 71 lb.

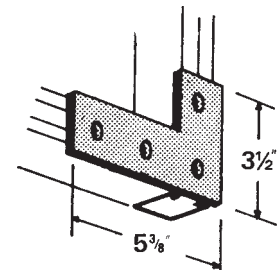

**Standard Dimensions**

Hole Spacing  
Hole Spacing  
Hole Size  
Material  
Material

13/16 in. From End  
1-7/8 in. Centers  
9/16 in. Diam.  
1-5/8 in. Width  
1/4 in. Thick

**Materials**

HDG(C)  
EG(C)  
(No suffix)  
SS6(C)

Hot-Dipped Galvanized  
ElectroGalvanized  
GoldGalv®  
Stainless Steel 316



## Fittings and Brackets

### Angular Fittings

#### AB225

AB225HDGC

AB225EG

AB225

AB225SS6

Wt./C 58 lb.

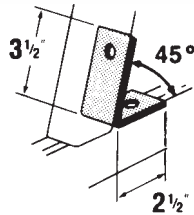

Other angles available. Contact your Regional Sales Office.

#### AB226

AB226HDGC

AB226SS6

Wt./C 119 lb.

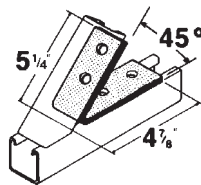

Other angles available. Contact your Regional Sales Office.

#### AB227

AB227HDGC

AB227EG

AB227

AB227SS6

Wt./C 58 lb.

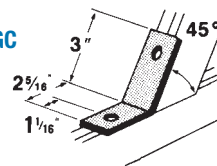

Other angles available. Contact your Regional Sales Office.

#### AB228

AB228HDGC

AB228SS6C

Wt./C 69 lb.

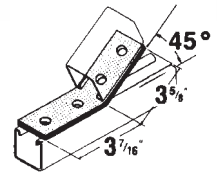

Other angles available. Contact your Regional Sales Office.

#### AB231

AB231EG

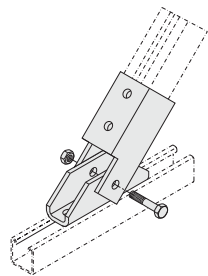
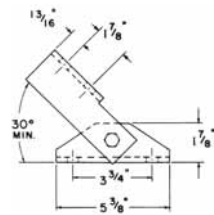

#### AB232

AB232EG

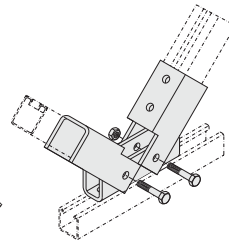
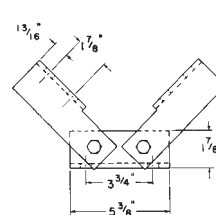

#### AB239

\*Finishes

- HDGC
- GoldGalv®
- EG

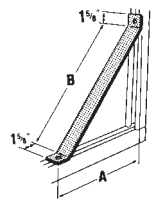

Cat. No.	A (in.)	B (in.)	Wt./C lb.
AB239-1*	7-13/16	8-1/2	148
AB239-2*	13-3/4	17	255
AB239-3*	19-3/4	25-1/2	363

### "Z" Shape Fittings

#### A209

A209HDGC

A209EG

A209

A209SS6

Wt./C 55 lb.

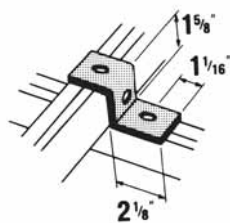

For attaching A and AR Series channel.

#### B209

B209HDG

B209EG

B209

Wt./C 43 lb.

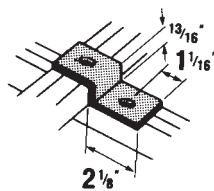

For attaching B and BR Series channel.

#### C209

C209

Wt./C 49 lb.

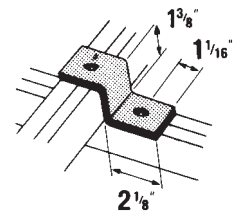

For attaching C Series channel.

#### D209

Wt./C 45 lb.

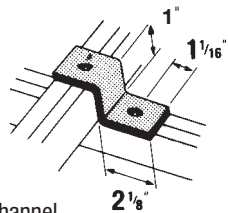

For attaching D Series channel.

#### CZ209

For attaching H Series and A back to back.

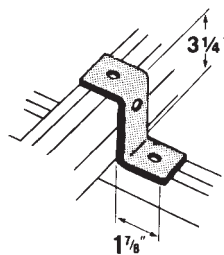

#### EZ209

EZ209HDGC

EZ209EG

EZ209

EZ209SS6

For attaching E Series channel.

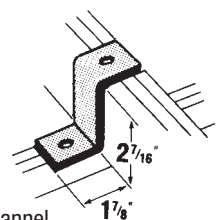

Standard Dimensions

Hole Spacing  
Hole Spacing  
Hole Size  
Material

13/16 in. From End  
1-7/8 in. Centers  
9/16 in. Diam.  
1-5/8 in. Width  
1/4 in. Thick

Materials

HDG(C)  
EG(C)  
(No suffix)  
SS6(C)

Hot-Dipped Galvanized  
Electrogalvanized  
GoldGalv®  
Stainless Steel 316

## Fittings and Brackets

### "U" Shape Fittings

#### A208

A208HDGC

A208EG

A208

A208SS6C

Wt./C 275 lb.

Does not include stud nut or bolts.

For A and AR Series channel.

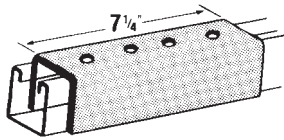

#### A213 Inside Joiner

Wt./C 40 lb.

For A1200 Series.

Available only in GoldGalv® finish.

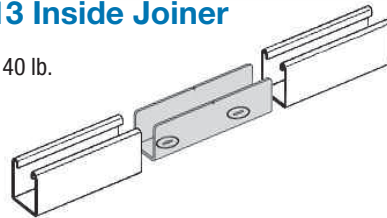

#### A210

A210HDGC

A210EG

A210

A210SS6C

Wt./C 88 lb.

For attaching A and AR Series channel.

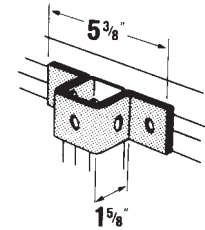

#### A211

A211HDGC

A211EG

A211

Wt./C 128 lb.

For attaching A and AR Series double channel, and H Series.

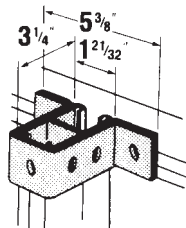

#### AN211

AN211HDGC

AN211EG

AN211

Wt./C 181 lb.

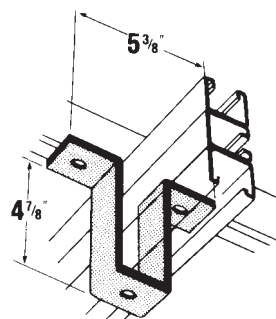

#### A212

A212HDGC

A212EG

A212

A212SS6

Wt./C 113 lb.

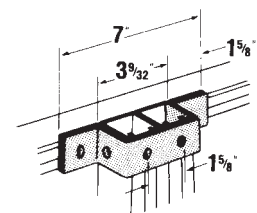

#### B210

B210HDGC

B210EG

B210

B210SS6

Wt./C 65 lb.

For attaching B and BR Series.

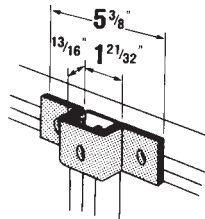

#### C210

C210HDGC

C210EG

C210

Wt./C 77 lb.

For attaching C Series channel.

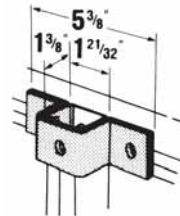

#### D210

D210HDGC

D210EG

D210

D210SS6

Wt./C 71 lb.

For attaching D Series channel.

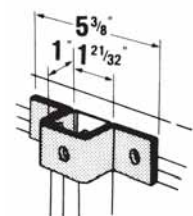

#### E210

E210HDGC

E210EG

E210

Wt./C 112 lb.

For attaching E Series channel.

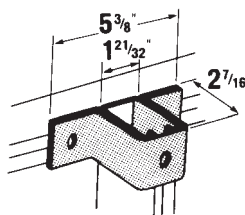

#### AB245

AB245HDGC

AB245EG

AB245

Wt./C 70 lb.

For attaching A and AR Series double channel.

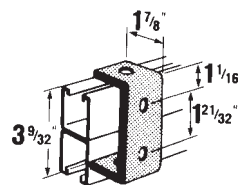

#### AB288

##### \*Finishes

- HDGC
- GoldGalv®
- EG

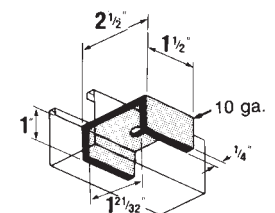

Cat. No.	Bolt Size (in.)	Wt./C lb.
AB288-3/8*	3/8	37
AB288-1/2*	1/2	
AB288-5/8*	5/8	

##### Standard Dimensions

Hole Spacing 13/16 in. From End  
Hole Spacing 1-7/8 in. Centers  
Hole Size 9/16 in. Diam.  
Material 1-5/8 in. Width  
Material 1/4 in. Thick

##### Materials

HDG(C)  
EG(C)  
(No suffix)  
SS6(C)

Hot-Dipped Galvanized  
ElectroGalvanized  
GoldGalv®  
Stainless Steel 316

## Fittings and Brackets

### Wing Fittings

#### AW204

AW204HDG

AW204EG

AW204

Wt./C 76 lb.

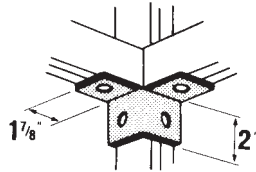

#### AW214

AW214HDG

AW214EG

AW214

Wt./C 115 lb.

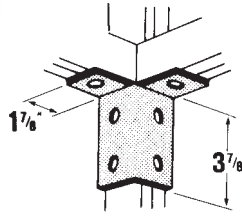

#### A217

AW217HDG

A217EG

A217

Wt./C 155 lb.

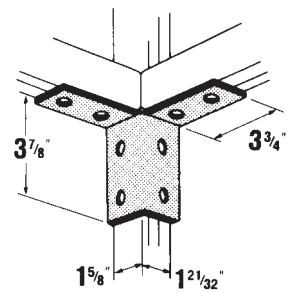

#### AW205L

AW205LHDG

AW205LEG

AW205L

Wt./C 59 lb.

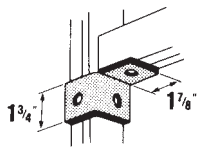

#### AW205R

AW205REG

AW205R

Wt./C 59 lb.

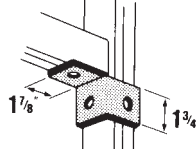

#### AW215L

AW215LHDG

AW215LEG

AW215L

Wt./C 98 lb.

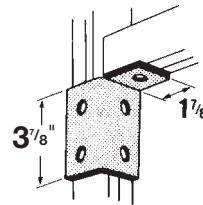

#### AW215R

AW215RHDG

AW215REG

AW215R

Wt./C 98 lb.

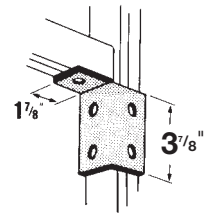

#### AW220

AW220HDGC

AW220EG

AW220

Wt./C 90 lb.

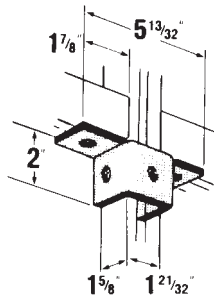

#### AW224

AW224HDGC

AW224EG

AW224

Wt./C 147 lb.

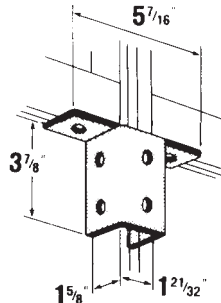

#### AW219

AW219HDGC

AW219EG

AW219

Wt./C 187 lb.

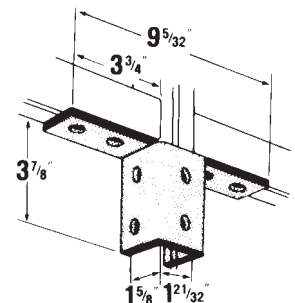

#### AW226

AW226HDG

AW226

Wt./C 113 lb.

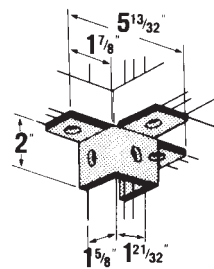

#### A218

A218HDG

A218EG

A218

Wt./C 177 lb.

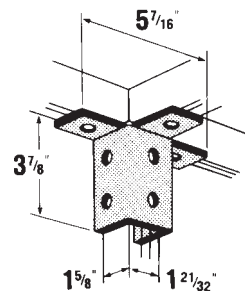

#### AW228

AW228HDG

AW228EG

AW228

Wt./C 230 lb.

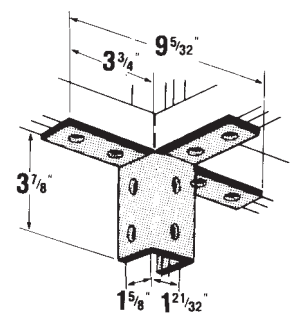

Standard Dimensions

Hole Spacing  
Hole Spacing  
Hole Size  
Material

13/16 in. From End  
1-7/8 in. Centers  
9/16 in. Diam.  
1-5/8 in. Width  
1/4 in. Thick

Materials

HDG(C)  
EG(C)  
(No suffix)  
SS8(C)

Hot-Dipped Galvanized  
Electrogalvanized  
GoldGalv®  
Stainless Steel 316

## Fittings and Brackets

### Brackets

### S202

- \*Finishes**
- HDG

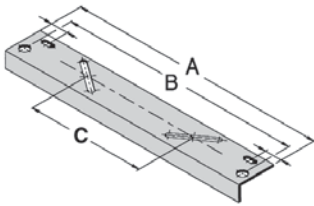

Cat. No.	A (in.)	B (in.)	C (in.)	Wt./C lb.
S202-6*	6	5	—	75
S202-9*	9	8	2	100
S202-15*	15	14	18	175
S202-21*	21	20	14	250
S202-27*	27	26	20	325
S202-33*	33	32	26	400

### S203

- \*Finishes**
- HDG

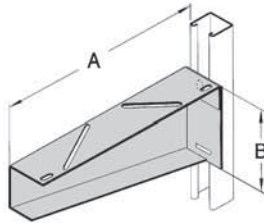

Cat. No.	A (in.)	B (in.)	Design Load/lb.	Wt./C lb.
S203-8*	8-1/2	4-1/16	1200	180
S203-14*	14-1/2	5-3/8		325
S203-20*	20-1/2	6-11/16		525
S203-26*	26-1/2	8		675
S203-32*	32-1/2	8		840
S203-38*	38-1/2	8		1050

### S249

- \*Finishes**
- HDG
  - SS6C

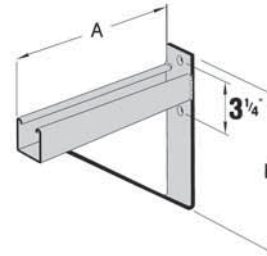

Cat. No.	A (in.)	B (in.)	Design Load/lb.	Wt./C lb.
S249-8*	8-1/2	8	1500	320
S249-14*	14-1/2	9		520
S249-20*	20-1/2	9		660
S249-26*	26-1/2	11-1/2		870
S249-32*	32-1/2	11-1/2		1030
S249-38*	38-1/2	11-1/2		1230

### S250

- \*Finishes**
- HDG
  - SS6C

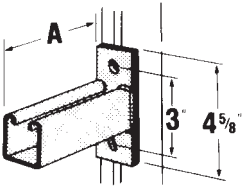

Cat. No.	A (in.)	Design Load/lb.	Wt./C lb.
S250-6*	6	1500	150
S250-8*	8-1/2	1500	150
S250-12*	12	800	250
S250-14*	14-1/2	800	250
S250-18*	18	550	350
S250-20*	20-1/2	550	350
S250-24*	24	400	450
S250-26*	26-1/2	400	450

May be installed inverted with no change in load ratings.

### S251

- \*Finishes**
- HDG
  - SS6C

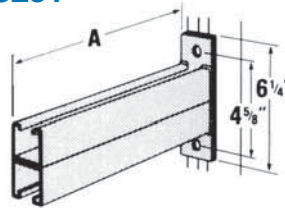

Cat. No.	A (in.)	Design Load/lb.	Wt./C lb.
S251-12*	12	1650	514
S251-14*	14-1/2	1650	514
S251-18*	18	1050	714
S251-20*	20-1/2	1050	714
S251-24*	24	800	914
S251-26*	26-1/2	800	914
S251-30*	30	650	1114
S251-32*	32-1/2	650	1114
S251-36*	36	500	1314
S251-38*	38-1/2	500	1314

### S256

- \*Finishes**
- HDG
  - SS6C

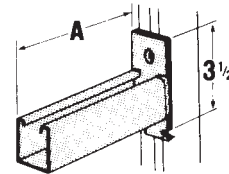

Cat. No.	A (in.)	Design Load/lb.	Wt./C lb.
S256-6*	6	1000	151
S256-8*	8-1/2	1000	151
S256-12*	12	500	251
S256-14*	14-1/2	500	251
S256-18*	18	300	351
S256-20*	20-1/2	300	351
S256-24*	24	250	451
S256-26*	26-1/2	250	451

When installed in inverted position reduce load rating 40%.

### S247

- S247HDG  
S247  
S247SS6

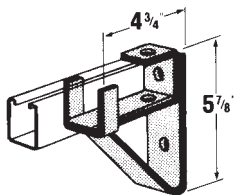

**Design Moment**  
(channel upright as shown)  
**When Supported By**  
A-1200 5250 inch lb.  
A-1400 3650 inch lb.

Applies to fitting only, not to the arm.

### S248

- S248HDGC  
S248

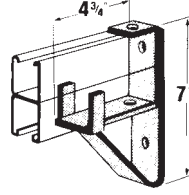

**Design Moment**  
(channel upright as shown)  
**When Supported By**  
A-1202 10 800 inch lb.  
A-1402 7550 inch lb.

Applies to fitting only, not to the arm.

**Standard Dimensions**

Hole Spacing  
Hole Spacing  
Hole Size  
Material  
Material

13/16 in. From End  
1-7/8 in. Centers  
9/16 in. Diam.  
1-5/8 in. Width  
1/4 in. Thick

**Materials**

HDG(C)  
EG(C)  
(No suffix)  
SS6(C)

Hot-Dipped Galvanized  
ElectroGalvanized  
GoldGalv®  
Stainless Steel 316

## Fittings and Brackets

### Brackets

#### S204

S204HDGC

S204

Wt./C 174 lb.

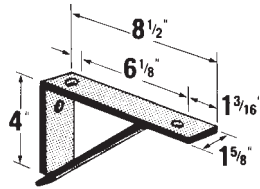

Design Uniform Load/lb.	
A-1200	750
A-1400	500

#### S205

S205HDGC

S205

Wt./C 264 lb.

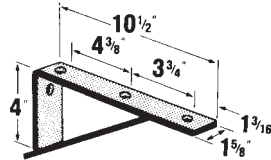

Design Uniform Load/lb.	
A-1200	750
A-1400	500

#### S217

S217HDG

S217

S217SS6

Wt./C 264 lb.

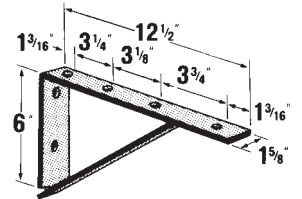

Design Uniform Load/lb.	
A-1200	750
A-1400	650

#### S218

S218HDG

S218

Wt./C 295 lb.

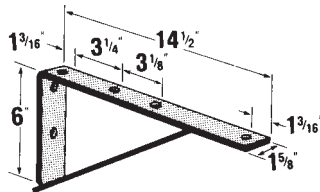

Design Uniform Load/lb.	
A-1200	750
A-1400	650

#### S222

S222HDG

S222

Wt./C 385 lb.

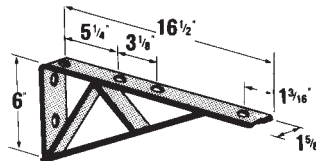

Design Uniform Load/lb.	
A-1200	1000
A-1400	750

#### S226

S226HDG

S226

Wt./C 421 lb.

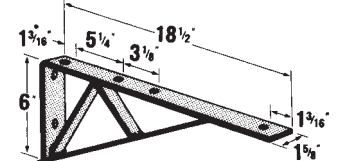

Design Uniform Load/lb.	
A-1200	1000
A-1400	750

## Fittings and Brackets

### Post Bases

#### AP232

AP232HDGC

AP232EG

AP232

Wt./C 384 lb.

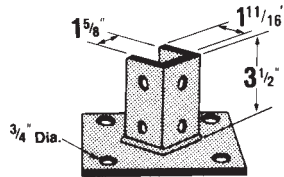

#### AP235

AP235HDGC

AP235EG

AP235

Wt./C 400 lb.

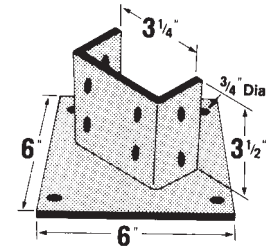

#### AP232SQ

AP232SQHDGC

AP232SQEG

AP232SQSS6

Wt./C 384 lb.

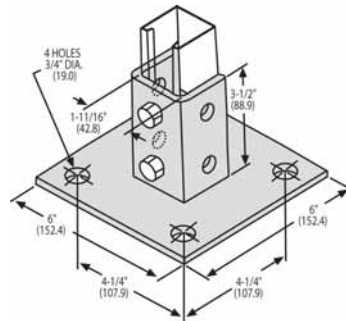

#### AP235SQ

AP235SQHDGC

AP235SQEG

AP235SQ

AP235SQSS6

Wt./C 400 lb.

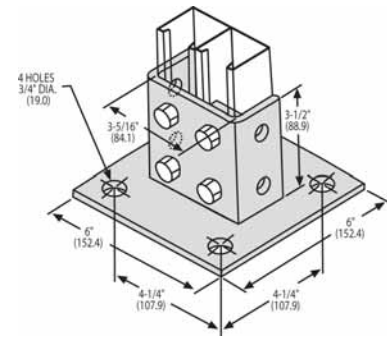

#### AN270

\*Finishes

- HDG
- EG

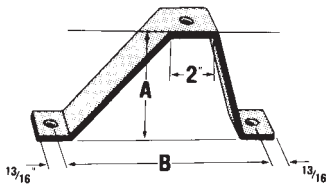

#### TS272 Track Support

TS272HDG

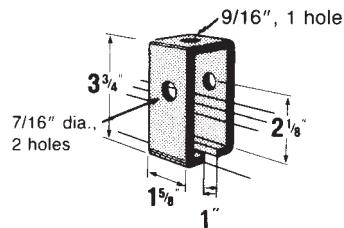

Requires 3/8 in. x 2-1/2 in. bolt and nut (not included)

Design load: 1000 lb.

Wt./C 104 lb.

#### TS273 Track Support

TS273HDG

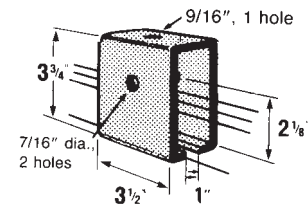

For use over channel splice

Requires 3/8 in. x 2-1/2 in. bolt and nut (not included)

Design load: 2000 lb.

Wt./C 228 lb.

Cat. No.	A	B	Wt./C lb.
AN270-1*	2-3/8	6	113
AN270-2*	4-3/8	8	151
AN270-3*	6-3/8	10	199
AN270-4*	8-3/8	12	246
AN270-*	10-3/8	14	293

## Fittings and Brackets

### Special Application Fittings and Brackets

#### TR292

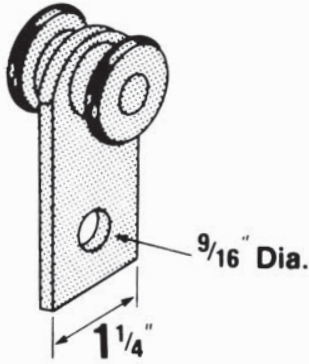

Can be used for Series A, E and H channels only.

Standard finish is ElectroGalvanized.

Frictionless needle bearings.

Design load: 500 lb.

Safety factor of 5.

Wt./C 59 lb.

#### TR294

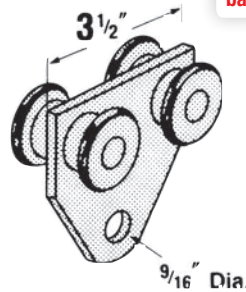

Do not use with back to back Strut

Can be used for Series A, E and H channels only.

Standard finish is ElectroGalvanized.

Frictionless needle bearings.

Design load: 1000 lb.

Safety factor of 5.

Wt./C 106 lb.

#### C728 Pipe Roller (Pair)

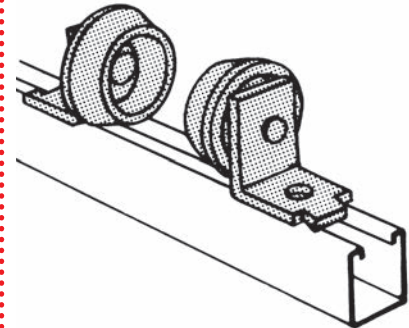

Cast aluminum rollers, steel brackets. Designed for standard saddles. Order separately for each pair of rollers: two 1/2 in. x 5/16 in. hex head cap screws and two 1/2 in. channel nuts. Space to suit O.D. of pipe and wrapping.

Design Load: 2350 lb.

Wt./C : 300 lb.

## Adjustable Universal Support

Support building services and access equipment on flat roofs and flat surfaces



The T&B Adjustable Universal Support (AUS) provides an easy method for supporting pipes, conduit and equipment on flat roofs, below raised floors and even on level ground applications. The AUS reduces installation time compared to other support solutions such as wooden blocks, cement blocks, straps and clips. These labor intensive solutions also increase the danger of roof membrane penetration.

The AUS system also allows for tool free adjustment of the pedestal height from 6 to 9 inches with a twist of the wrist. This ensures that the supported objects or pipes are uniformly supported and no high stress supports are carrying a disproportionate load in a single location.

Cat. No.	Description	Qty.
<b>AUS14-96</b>	Adjustable Universal Support (Base only)	1
<b>AUS-RISER-KIT</b>	Riser Kit	
A1200HS100PG	14 in. strut	1
H104-1/2X10EGC	12 in. threaded rod	2
E145-1/2EGC	Nut	8
E147-1/2EGC	Washer	8
E148-1/2EGC	Lock washer	4
<b>AUS-STRUT-KIT</b>	Bolt Kit	
A1200HS100PG	14 in. strut	1
E142-1/2X200EGC	Bolt	2
E145-1/2EGC	Nut	2
E147-1/2EGC	Washer	4
E148-1/2EGC	Lock washer	2
<b>AUS125PCSS6</b>	4-1/2 in. stainless steel 316 strap (to restrain 1-1/4 in. pipe)	2
<b>AUS150PCSS6</b>	5 in. strap (to restrain 1-1/2 in. pipe)	2
<b>AUS200PCSS6</b>	6 in. strap (to restrain 2 in. pipe)	2

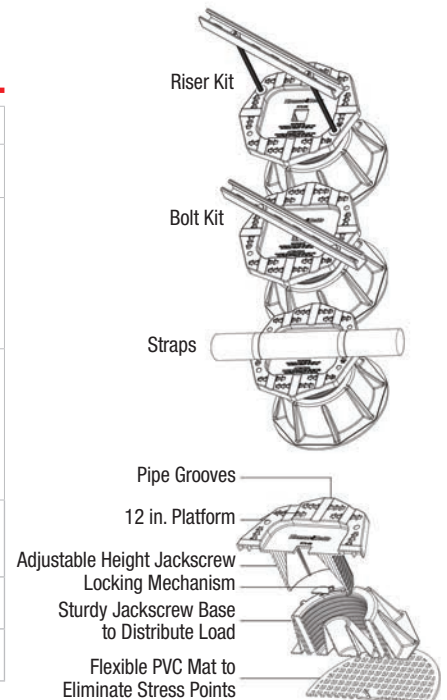

## Beam Clamps

.....

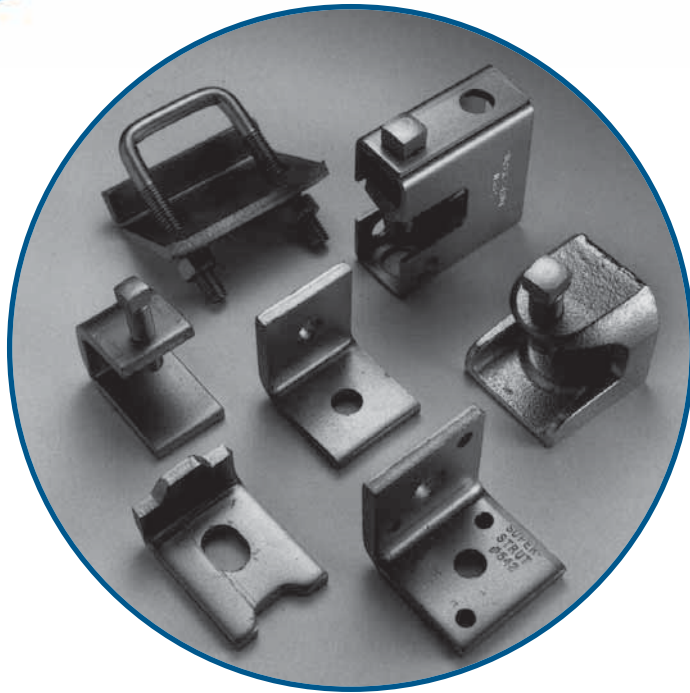

### Design Loads

Where design loads are indicated, they provide for a safety factor of 3 in conformance with the American Standard Code for Pressure Piping. For more information, see page A57 for Engineering Data and Specifications.

### Finishes and Special Materials

Hot-Dipped Galvanized (HDGC) is standard for all Superstrut® beam clamps. The material is zinc coated after fabrication providing total product protection on all surfaces. The fabricated beam clamps are suspended and then dipped into tanks of hot zinc for a prolonged period, creating a coherent bond.

Selected beam clamps can also be available in GoldGalv® (no suffix) or Stainless Steel Type 316 (SS6C). Contact your Regional Sales Office for availability and minimum quantities.



## Beam Clamps

### Beam Clamps for Mounting Channel

#### U501, U502

**\*Finishes**

- HDG
- EG
- GoldGalv®
- SS6C

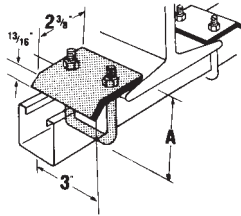

Cat. No.	For Channel	Size (in.)	Wt./C lb.
U501*	A1200 A1400	3-3/16	90
	B1200 B1400		
	C1200 B1402		
U502*	A1202 A1402	4-13/16	100
	C1202 H1200		

Furnished complete.

Design Load U501 : 2150 lb.

U502 : 3000 lb.

#### U504

- U504HDG
- U504EG
- U504
- U504SS6

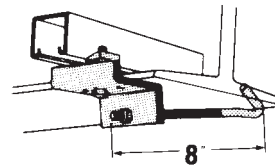

Can be used with all channels.

Wt./C 140 lb.

#### U505

- U505HDG
- U505EG
- U505

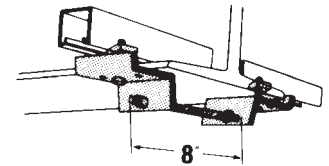

Can be used with all channels.

Wt./C 270 lb.

#### U510

- U510HDGC
- U510EG
- U510
- U510SS6

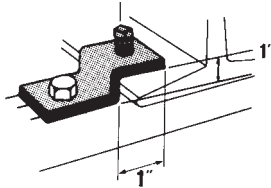

Design Load/lb.	Channel
1000	A-1200
800	A-1400

1/2 in. x 1-1/2 in. set screw included.

Order separately one 1/2 in. x 1-1/2 in. hex head cap screw and 1/2 in. channel nut.

Wt./C 75 lb.

#### 512U

- 512UHDG
- 512UEG
- 512U

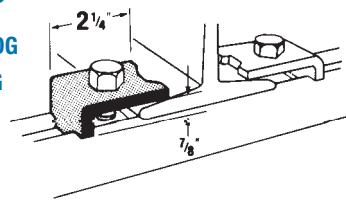

Design Load/lb.	Channel
1000	A-1200
800	A-1400

Order separately one 1/2 in. x 1-1/2 in. hex head cap screw and 1/2 in. channel nut.

Wt./C 26 lb.

#### U514

- U514HDGC
- U514EG
- U514
- U514SS6

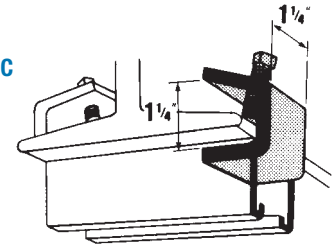

3/8 in. x 1-1/2 in. set screw included.

Design Load 750 lb./pair

Wt./C 40 lb.

#### U514-A

- U514-AHDGC
- U514-AEG
- U514-A
- U514-ASS6

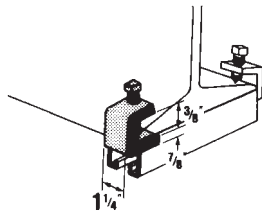

1/2 in. x 1-1/2 in. set screw included.

Design Load 1650 lb./pair

Wt./C 59 lb.

#### U515

- U515HDGC
- U515EG
- U515
- U515SS6

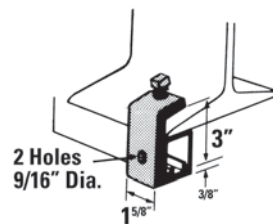

For all A Series channel.

1/2 in. x 1-1/2 in. set screw included.

Design Load 800 lb.

Wt./C 95 lb.

#### U515B

- U515BHDG
- U515BEG
- U515B
- U515BSS6

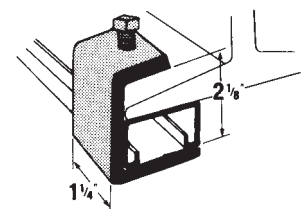

For all B Series channel.

1/2 in. x 1-1/2 in. set screw included.

Design Load 800 lb.

Wt./C 91 lb.

**Materials**  
 HDG(C) Hot-Dipped Galvanized  
 EG(C) ElectroGalvanized  
 (No suffix) GoldGalv®  
 SS6(C) Stainless Steel 316

## Beam Clamps

### Beam Clamps for Mounting Channel

#### U520, U521, U522

**\*Finishes**

- GoldGalv®

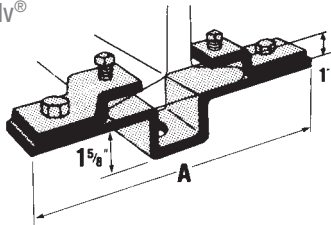

Nuts, cap screws and set screws included.

Cat. No.	Flange Width	A	Wt./C lb.	Design Load lb./ea
U520*	2-3/8 - 4-1/2	8-3/4	328	2000
U521*	3-3/4 - 5-3/4	10	343	1300
U522*	5-5/8 - 7-5/8	11-7/8	353	900

#### A597

**\*Finishes**

- HDGC
- SS6C

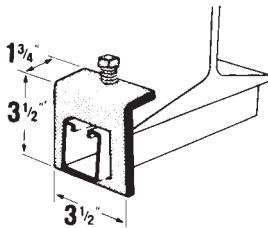

Cat. No.	Channel Series	Wt./C lb.	Design Load lb./ea
A597*	A	108	800

#### U544 Single Adjusting Screw End Cap Set

U544EG

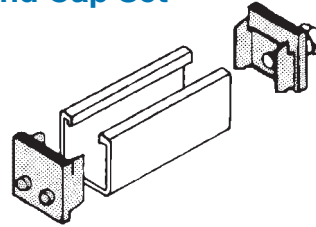

Should be ordered as one set.  
Wt./C 39 lb.

#### U543 Adjusting Screw End Caps

U543HDG

U543EG

U543

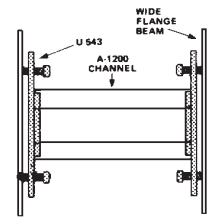

Should be ordered in multiples of two (2).  
Wt./C 44 lb.

#### U570-1, U570-2

**\*Finishes**

- HDGC

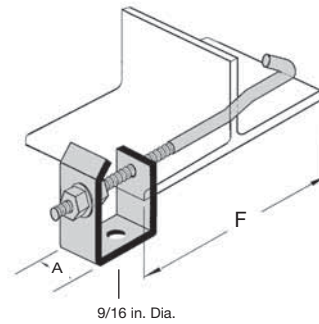

Cat. No.	A (in.)	F (in.)	Wt./C lb.	Design Load lb./ea
U570-1*	1-1/2	4 to 9	240	800
U570-2*	1-1/2	7 to 17	300	800

**Materials**

HDG(C)  
EG(C)  
(No suffix)  
SS6(C)

Hot-Dipped Galvanized  
ElectroGalvanized  
GoldGalv®  
Stainless Steel 316

## Beam Clamps

### Beam Clamps for Hanging Rod

#### U562 Beam Clamp

U562HDG  
U562EG  
U562  
U562SS6

Optional Use of  
U562HDG  
Beam Clamp

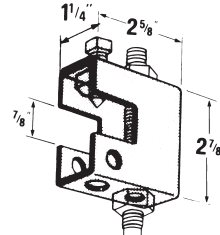
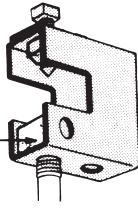

E146 square nut order separately.  
1/2 in. set screw included.

1/2 in. set screw included.

Rod Size (in.)	Wt./C lb.	Design Load lb./ea
1/2	80	800

Rod Size (in.)	Wt./C lb.	Design Load lb./ea
1/2	80	500

For 20° swivel application use ES-145-1/2 nut.

#### UM562 Beam Clamp

UM562HDGC  
UM562EG  
UM562  
UM562SS6

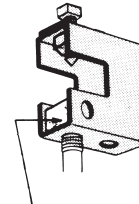

E146 square nut order separately.  
1/2 in. set screw included.

Rod Size (in.)	Wt./C lb.	Design Load lb./ea
1/2	100	1200

For 20° swivel application use ES-145-1/2 nut.

#### US562 Beam Clamp with Swing Hanger

US562HDG  
US562EG  
US562

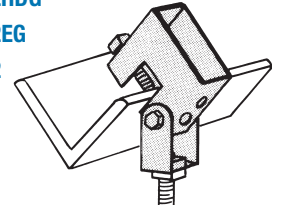

1/2 in. set screw included.

Rod Size (in.)	Wt./C lb.	Design Load lb./ea
1/2	113	800

#### U563 Beam Clamp

U563HDG  
U563EG  
U563  
U563SS6

Optional Use of  
U563HDG  
Beam Clamp

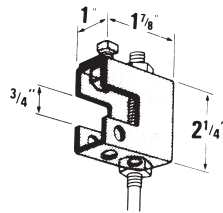
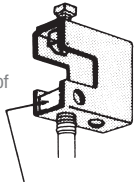

Square nut order separately.  
3/8 in. set screw included.

3/8 in. set screw included.

Rod Size (in.)	Wt./C lb.	Design Load lb./ea
3/8	33	400

Rod Size (in.)	Wt./C lb.	Design Load lb./ea
3/8	33	240

#### US563 Beam Clamp with Swing Hanger

US563HDG  
US563

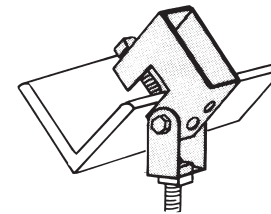

3/8 in. set screw included.

Rod Size (in.)	Wt./C lb.	Design Load lb./ea
3/8	50	400

#### U569 Beam Clamp

U569HDG  
U569

Maximum flange width 5 in.

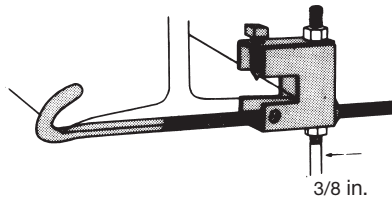

Cat. No.	A Size (in.)	Wt./C lb.	Design Load lb./ea
U569	3/8	150	400

#### A570 Beam Clamp with Safety Rod

A570HDG

Flange width 4 in. min. - 8 in. max.  
For use with 3/8 in. rod see U-569.

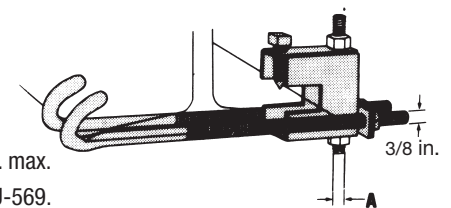

Cat. No.	A Size (in.)	Wt./C lb.	Design Load lb./ea
A570HDG	1/2	220	500

Materials HDG(C) Hot-Dipped Galvanized  
EG(C) ElectroGalvanized  
(No suffix) GoldGalv®  
SS6(C) Stainless Steel 316

## Beam Clamps

### Beam Clamps for Hanging Rod

#### U560 Heavy Duty Beam Clamp

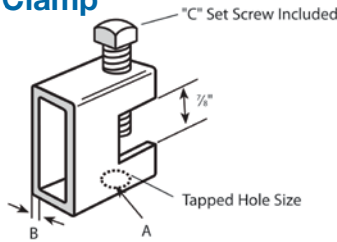

- \*Finishes
- GoldGalv®
  - EG

Cat. No.	A (in.)	B (in.)	C (in.)	Wt./C lb.	Design Load, lb.
U560-1/4*	1/4	1/8	3/8 x 1-1/2	67	1050
U560-3/8*	3/8	1/8	3/8 x 1-1/2	67	1050
U560-1/2*	1/2	1/4	1/2 x 1-1/2	130	2650
U560-5/8*	5/8	1/4	1/2 x 1-1/2	130	2650

#### U564 Heavy Duty Beam Clamp

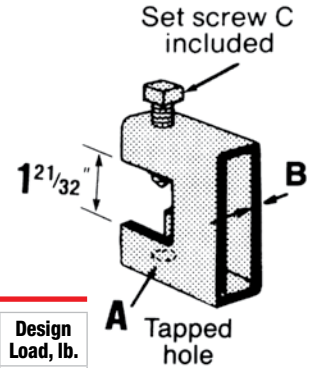

- \*Finishes
- GoldGalv®
  - EG

Cat. No.	A (in.)	B (in.)	C (in.)	Wt./C lb.	Design Load, lb.
U564-3/8*	3/8	1/8	3/8 x 2-3/4	109	1300
U564-1/2*	1/2	1/4	1/2 x 2-3/4	201	3150
U564-5/8*	5/8	1/4	1/2 x 2-3/4	201	3150

#### U568 Beam Clamp Safety Strap

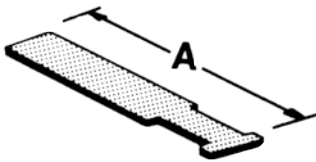

For U563 beam clamp.

Cat. No.	Beam Flange Width (in.)	A (in.)	Wt./C lb.
U568-1EG	6	8	18
U568-2EG	9	11	28

16 gauge material

#### U568 Beam Clamp Safety Strap

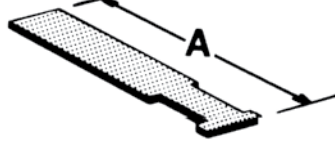

For U562 and UM562 beam clamp.

Cat. No.	Beam Flange Width (in.)	A (in.)	Wt./C lb.
U568-3EG	6	9	25
U568-4EG	9	12	33
U568-5EG	12	15	42

16 gauge material

#### U568 Beam Clamp Safety Strap



For U560 and U564 beam clamp.

Cat. No.	Beam Flange Width (in.)	A (in.)	Wt./C lb.
U568-4EG	6	9	33
U568-5EG	9	12	42
U568-6EG	12	15	24

16 gauge material

#### C775L / M775L Clamp with Lock Nut

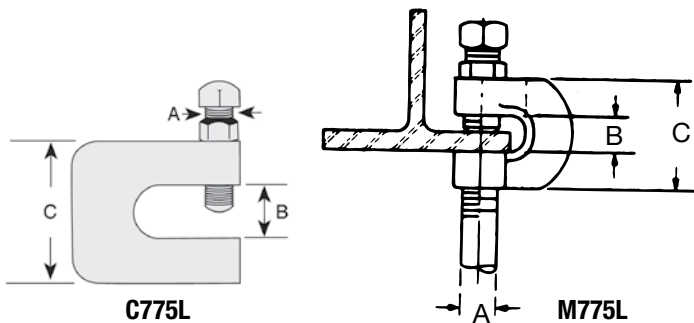

#### Standard Finish - Electrogalvanized (EG)

Malleable Iron (M775L)

Carbon Steel (C775L)

Cat. No.	Pipe Size (in.)	Dimensions			Wt./C lb.	Design Load, lb.
		A (in.)	B (in.)	C (in.)		
C775L-3/8EG	3/8	3/8	3/8	3/4	38	400
C775L-1/2EG	1/2	3/8	3/8	3/4	39	500
C775L-5/8EG	5/8	1/2	1/2	3/4	60	550
C775L-3/4EG	3/4	5/8	5/8	3/4	69	600
C775L-7/8EG	7/8	3/4	3/4	1	184	900
M775L-3/8EG	3/8	3/8	3/4	1-3/4	27	400
M775L-1/2EG	1/2	1/2	3/4	1-3/4	35	400
M775L-5/8EG	5/8	5/8	3/4	2	52	440
M775L-3/4EG	3/4	3/4	3/4	2	63	500

Materials	HDG(C)	EG(C)	(No suffix)	SS6(C)
	→ Hot-Dipped Galvanized	→ Electrogalvanized	→ GoldGalv®	→ Stainless Steel 316

## Beam Clamps

### Beam Clamps for Hanging Rod

500SC, 502, 503SC, 507, 508, 509, 510, 511 Beam Clamp

Standard Finish -

Electrogalvanized (no suffix)

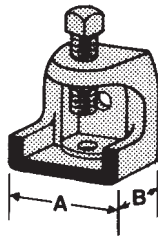

Cat. No.	Tapped Holes	Base Dim.		Jaw Opening (in.)	Wt./C lb.	Design Load/lb.
		A (in.)	B (in.)			
500SC	1/4 - 20	1	1-1/4	15/16	18	450
502	3/8 - 16	2	2	1	92	1300
503SC	1/2 - 13	2-5/8	2-1/2	1	164	1300
507	1/2 - 13	2-1/2	2-3/8	1-3/8	165	1700
508	1/2 - 13	2-1/2	2-3/8	2-1/8	184	1700
509	10 - 24	1	1-1/4	15/16	22	375
510	1/4 - 20	27/32	1-1/8	5/8	15	400
511	10 - 24	27/32	1-1/8	5/8	15	400

### 6H Series in combination with 500 Series Beam Clamp Conduit and Pipe Hanger

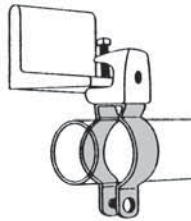

#### Features

- Accommodates 1/2 in. through 4 in. EMT or rigid conduit
- Can be used for either vertical or horizontal installation
- 6H-TB Series is threaded so there are less parts to handle or drop
- Installs easily with a screwdriver

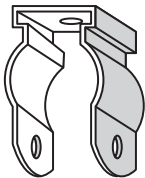

6H Series without bolt  
Fig. 1



6H-B Series with bolt and hex nut  
Fig. 2



6H-T Threaded Series threaded without bolt  
Fig. 3



6H-TB Threaded Series threaded with bolt  
Fig. 4

Without Bolt		With Bolt		EMT (in.)	Rigid Conduit or Pipe (in.)	Qty. per Box
Cat. No.	Fig. No.	Cat. No.	Fig. No.			
6H0	1	6H0-B	2	1/2	3/8-1/2	100
6H0-T	3	6H0-TB	4			
6H1	1	6H1-B	2	3/4	3/4	
6H1-T	3	6H1-TB	4			
6H2	1	6H2-B	2	1	1	
		6H2-TB	4			
6H2 1/2	1	6H2 1/2B	2	1-1/4	-	
		6H2 1/2-TB	4			
6H3-SC	1	6H3-B	2	1-1/2	1-1/4	
		6H3-TB	4			
6H4	1	6H4-B	2	-	1-1/2	
		6H4-TB	4			
6H5	1	6H5-B	2	2	2	
		6H5-TB	4			
6H6	1	6H6-B	2	2-1/2	2-1/2	
6H7	1	6H7-B	2	3	3	
6H8	1	6H8-B	2	3-1/2	3-1/2	
6H9	1	6H9-B	2	4	4	

Standard Finish - Electrogalvanized (no suffix). Use SS suffix for Stainless Steel.

Load rating: 500 lb. with a safety factor of 3. (For weight per 100 see page A38.)

## Beam Clamps

### Beam Clamps for Mounting Pipe and Conduit

#### U571, U572 Conduit Clamp

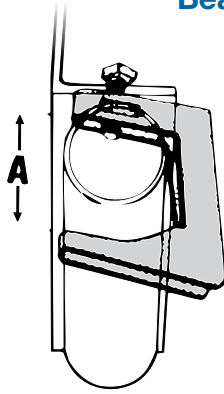

For attaching 1/2 in. thru 1-1/2 in. conduit to beam, channel, angle or column. Secures conduit to the support parallel or at right angles to it.

5/16 in. set screw

12 gauge material

Standard Finish - GoldGalv®

Wt./C 38 lb.

Cat. No.	Conduit Size (in.)	Max. Flange Thickness (in.)	Dim. A (in.)	Wt./C lb.
U571	1/2	1	1-3/4	36
	3/4	3/4		
	1	1/2		
U572	3/4	1-1/2	2-1/2	59
	1	1-1/4		
	1-1/4	1		
	1-1/2	5/8		

## Pipe Supports

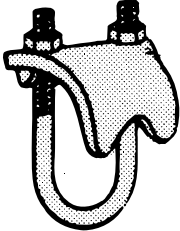

Type RC and RCS

- Malleable Iron
- For mounting pipe or conduit at right angles to the beam
- Use SS316 suffix for 316 Stainless Steel
- Use HDG suffix for Hot-Dipped Galvanized

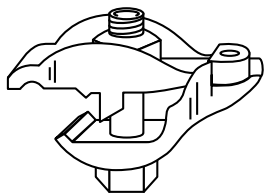

Type EC

- Malleable Iron
- For mounting pipe or conduit vertically across the beam
- Use HDG suffix for Hot-Dipped Galvanized
- CSA Certified

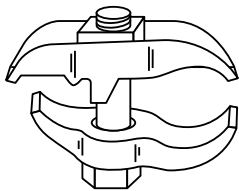

Type PC

- Malleable Iron
- For mounting pipe or conduit parallel to the beam
- Use HDG suffix for Hot-Dipped Galvanized

### Pipe Supports

Three types of pipe clamps are available to provide right angle, vertical and parallel attachment to a beam. Types RC, EC and PC are malleable iron clamps with an edge that grips the structural member for maximum holding power when tightened.

Type RCS clamps are all steel, providing two bearing surfaces for strong attachment for mounting pipe or conduit at right angles to the beam.

All parts are electrogalvanized (no suffix) including the threads. The clamps are designed for clamping to a wide variety of beam thicknesses and tapers. Can be installed using only a wrench.

Cat. No. and Size	O.D. of Conduit or Pipe (in.)	Nom. Conduit or Pipe Size (in.)	Std. Ctn.	Wt./C lb.
RCS-3/8	0.675	3/8	50	31
RCS-1/2	0.840	1/2		34
RCS-3/4	1.050	3/4		39
RCS-1	1.315	1		42
RCS-1-1/4	1.660	1-1/4		43
RCS-1-1/2	1.900	1-1/2		60
RCS-2	2.375	2		72
RC-1/2	0.840	1/2		36
RC-3/4	1.050	3/4		43
RC-1	1.315	1		49
RC-1-1/4	1.660	1-1/4	51	
RC-1-1/2	1.900	1-1/2	54	
RC-2-SC	2.375	2	25	76
RC-2-1/2	2.875	2-1/2		107
RC-3	3.500	3		116
RC-3-1/2	4.000	3-1/2		134
RC-4-SC	4.500	4	20	158
EC-1/2	0.840	1/2	50	69
EC-3/4	1.050	3/4		78
EC-1	1.315	1	25	83
EC-1-1/4	1.660	1-1/4		108
EC-1-1/2	1.900	1-1/2		112
EC-2	2.375	2	10	140
EC-2-1/2	2.875	2-1/2		183
EC-3	3.500	3	50	203
PC-3/8	0.675	3/8		32
PC-1/2	0.840	1/2		53
PC-3/4	1.050	3/4		53
PC-1	1.315	1	25	61
PC-1-1/4	1.660	1-1/4		79
PC-1-1/2	1.900	1-1/2		56
PC-2	2.375	2	10	116
PC-2-1/2	2.875	2-1/2		148
PC-3	3.500	3	10	175
PC-3-1/2	4.000	3-1/2		199
PC-4	4.500	4		224

## Beam Clamps

### Beam Fittings

#### C781 Square Washer

**\*Finishes**

- B
- EDG
- EG
- SS6

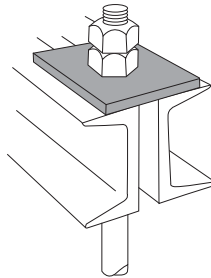

Used for beam applications.

For channel applications use AB241.

STD.  
PACK:  
50

Cat. No.	Rod Size (in.)	Hole Size (in.)	Overall Dimensions	Wt./C lb.
C781-3/8*	3/8	7/16	3 x 3 x 3/16	27
C781-1/2*	1/2	9/16	3 x 3 x 3/16	27
C781-5/8*	5/8	11/16	3 x 3 x 1/4	47
C781-3/4*	3/4	13/16	3 x 3 x 1/4	42
C781-7/8*	7/8	15/16	4 x 4 x 3/8	85
C781-1*	1	1-1/8	4 x 4 x 3/8	160

#### M742R Ceiling Flange

**\*Finishes**

- B
- EG

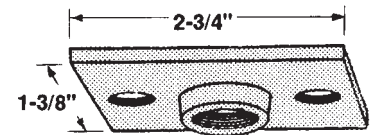

Cat. No.	Rod Size (in.)	Wt./C lb.
M742R-3/8*	3/8	16
M742R-1/2*	1/2	16

#### 540 Side Beam Hanger Clip

**\*Finishes**

- B
- EG
- GoldGalv®

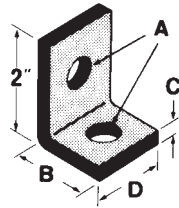

Cat. No.	A (in.)	B (in.)	C (in.)	D (in.)	Wt./C lb.
540-3/8*	7/16	1-7/8	1/4	7/8	38
540-1/2*	9/16	1-7/8	1/4	1-5/8	36
540-5/8*	11/16	2-1/2	3/8	2	84
540-3/4*	13/16	2-1/2	3/8	2	113

#### 542 Side Beam Hanger Clip

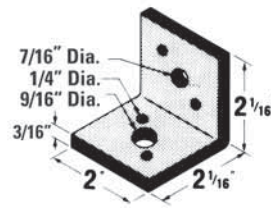

Cat. No.	Rod Size (in.)	Design Load/lb.	Wt./C lb.
542-3/8	3/8	610	35
542-1/2	1/2	1000	38

**Standard Finish - GoldGalv®**

For 3/8 in. and 1/2 in. rods.

#### S541 Swing Connector

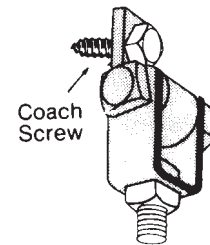

3/8 in. x 1-3/4 in. bolt, nut and clevis included.

Cat. No.	Rod Size (in.)	Wt./C lb.
S541-3/8	3/8	31

**Standard Finish - GoldGalv®**

For use with wood beam.

**Materials**

HDG(C)  
EG(C)  
(No suffix)

Hot-Dipped Galvanized  
ElectroGalvanized  
GoldGalv®

SS6(C)  
B

Stainless Steel 316  
Bare

## Beam Clamps

### Beam Fittings

#### U577 Clevis and Swing Connector

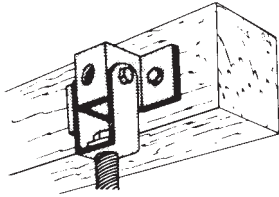

Cat. No.	Rod Size (in.)	Wt./C lb.
U577-1/2	1/2	69

**Standard Finish - GoldGalv®**

For use with wood beam.

#### U576 Hanger Clevis

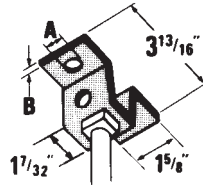

Cat. No.	Hole A (in.)	Material Thickness B (in.)	Wt./C lb.
U576-3/8	7/16	3/16	27
U576-1/2	9/16		

**Standard Finish - GoldGalv®**

For rods up to 1/2 in.

Mounting holes 7/16 in. diameter.

For use with wood beam.

#### U579 Ceiling Flange

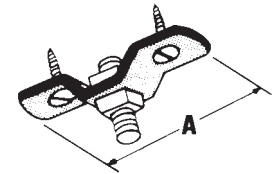

Cat. No.	A (in.)	Wt./C lb.
U579-3/8	3-1/2	30
U579-1/2	4-1/4	50

**Standard Finish - GoldGalv®**

Malleable Iron

Nuts and wood screws not included.

Mounting holes 13/32 in.

Materials

HDG(C)  
EG(C)  
(No suffix)

Hot-Dipped Galvanized  
ElectroGalvanized  
GoldGalv®

SS6(C)  
B

Stainless Steel 316  
Bare



## Pipe Straps, Pipe Clamps and Hangers

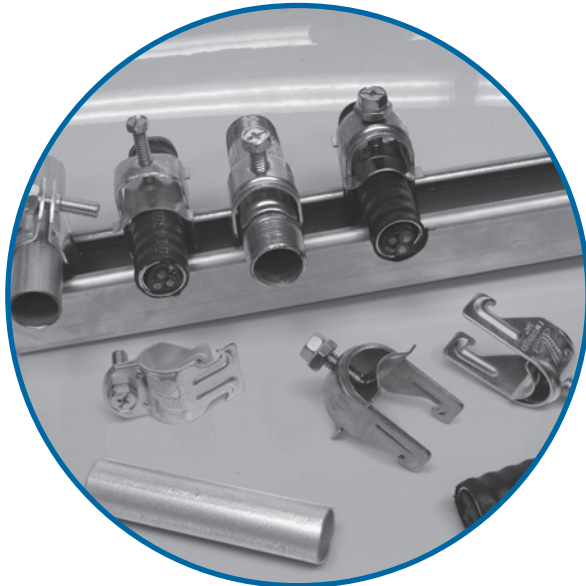

### Design Loads

Where design loads are indicated, they provide for a safety factor of 3 in conformance with the American Standard Code for Pressure Piping.

### Hanger Design

Pipe hangers are of advanced design to be user friendly.

### Finishes and Special Materials

The standard finish is Electrogalvanized (EGC) or GoldGalv®. Some products are offered in Aluminum and Stainless Steel where noted.

### 701 O.D. Pipe and Conduit Clamp

Machine screw and nut included.

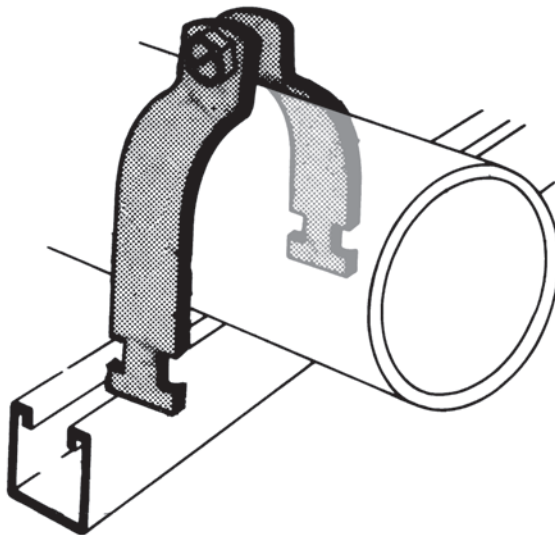

#### Standard Finishes and Materials

- PG** = Pregalvanized (i.e. 701-045PG)
- AL** = Aluminum (i.e. 701-045AL) with zinc plated hardware
- SS6** = Stainless Steel Type 316 (i.e. 701-045SS6)

N° de cat.	O.D. of pipe		Rigid Cond.	EMT Cond.	WT./C. lb.	Std. Pack
	(in.)	(mm)				
701-045PG	0.36-0.45	9-11.5	-	-	9	10
701-055PG	0.46-0.55	11.5-14	-	-	10	
701-065PG	0.56-0.65	14-17	-	-	11	
701-075PG	0.66-0.75	17-19.5	-	1/2	13	
701-088PG	0.76-0.88	19.5-22.5	1/2	-	15	
701-100PG	0.89-1.00	22.5-25.4	-	3/4	16	
701-113PG	1.01-1.13	25.5-29	3/4	-	17	
701-126PG	1.14-1.26	29-32	-	1	18	
701-140PG	1.27-1.40	32-36	1	-	18	
701-153PG	1.41-1.53	36-39	-	1-1/4	19	
701-167PG	1.54-1.67	39-42.5	1-1/4	-	20	
701-180PG	1.68-1.80	42.5-46	-	1-1/2	23	
701-193PG	1.81-1.93	46-49	1-1/2	-	26	
701-204PG	1.93-2.04	49-52	-	-	30	
701-225PG	2.10-2.25	53-57.5	-	2	32	
701-237PG	2.26-2.37	57.5-60	2	-	34	
701-245PG	2.33-2.45	59.95-62.5	-	-	36	
701-257PG	2.46-2.57	62.5-65.5	-	-	38	
701-287PG	2.75-2.87	70-73	2-1/2	2-1/2	40	
701-294PG	2.88-2.94	73-75	-	-	42	
701-306PG	2.95-3.06	75-78	-	-	42.5	
701-319PG	3.07-3.19	78-81	-	-	43	
701-350PG	3.36-3.50	85.5-89	3	3	45	
701-356PG	3.51-3.56	89-90	-	-	46	
701-379PG	3.70-3.79	94-96.5	-	-	48	
701-400PG	3.80-4.00	96.5-101.5	3-1/2	3-1/2	49	
701-450PG	4.25-4.50	108-114	4	4	70	
701-556PG	5.25-5.56	121-141	5	5	75	
701-665PG	6.25-6.65	146-170	6	6	80	
701-876PG	8.50-8.75	197-222	8	8	85	

## Pipe Straps, Pipe Clamps and Hangers

### Conduit and Cable Clamps

#### 703 Universal Clamp

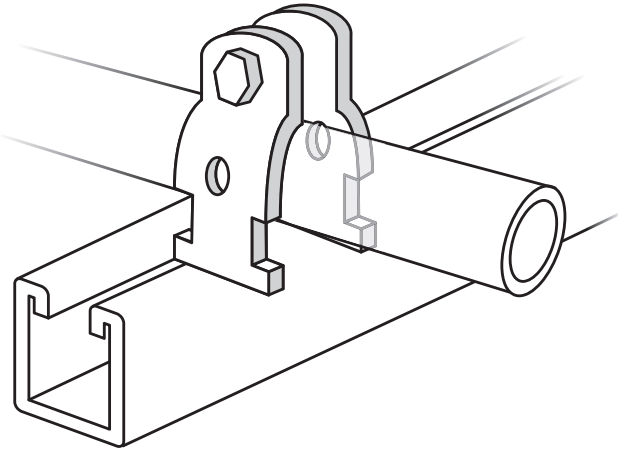

Cat. No.	EMT/ Rigid (in.)	Conduit O.D.O	Material Thickness	Wt./C lb.	Std. Ctn.
703-1/2EG	1/2	0.706 - 0.840	16 ga.	13	100
703-3/4EG	3/4	0.932 - 1.050	14 ga.	14	100
703-1EG	1	1.163 - 1.315	14 ga.	15	100
703-1-1/4EG	1-1/4	1.508 - 1.660	14 ga.	18	50
703-1-1/2EG	1-1/2	1.738 - 1.900	14 ga.	28	50
703-2EG	2	2.195 - 2.375	14 ga.	29	50

Standard Finishes - GoldGalv® (i.e.) 703-1/2

Electrogalvanized (EG suffix) (i.e.) 703-1-1/2EG

One size fits both Rigid and Electric Metal Tubing (EMT).

Individually assembled with screw and nut.

#### Quik Clamp II™

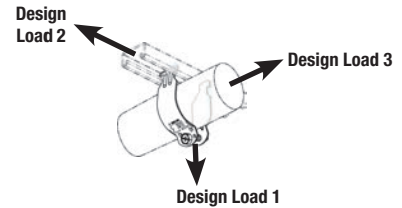
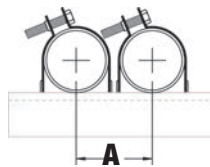

Design Load 1 has a safety factor of 4.  
Design Loads 2 and 3 have a safety factor of 1.

Cat. No.	Dimension A EMT in. (mm)	Dimension A Rigid Conduit in. (mm)	Quantity per Box	Wt./C lb.
TBQC050	1-5/16 (33.5)	1-1/4 (31.5)	100	10
TBQC075	1-3/4 (44.5)	1-11/16 (43)	100	12
TBQC100	1-13/16 (46)	1-3/4 (44.5)	100	13
TBQC125	2-1/8 (54)	2 (51)	50	15
TBQC150	2-3/8 (60.5)	2-3/16 (55.5)	50	16
TBQC200	2-5/8 (66.5)	2-1/2 (63.5)	50	19
TBQC250	3-1/16 (78)	3-1/16 (78)	25	29
TBQC300	3-11/16 (93.5)	3-11/16 (93.5)	25	34
TBQC350	4-3/16 (106.5)	4-3/16 (106.5)	25	38
TBQC400	4-11/16 (119)	4-11/16 (119)	25	42

Design Load 1 Static Load Limit lb. (kg)	Design Load 2 lb. (kg)	Design Load 3 lb. (kg)
200 (90)	50 (23)	50 (23)
200 (90)		
200 (90)		
200 (90)		
200 (90)		
200 (90)		
200 (90)		
350 (158)		
350 (158)		
350 (158)		

## Pipe Straps, Pipe Clamps and Hangers

### Conduit and Cable Clamps

#### Cobra®

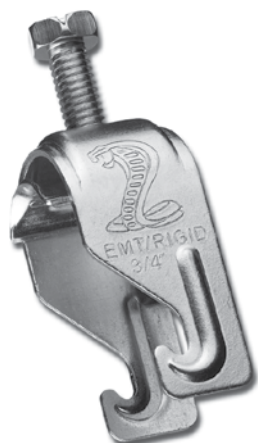

Standard material is commercial-grade, bright electrogalvanized steel. Stainless steel 316L is also available; add the suffix "SS6" to catalogue no. (i.e.: CPC050SS6). Stainless steel bolt head is hexagonal and slotted only. **Now available in aluminum.**

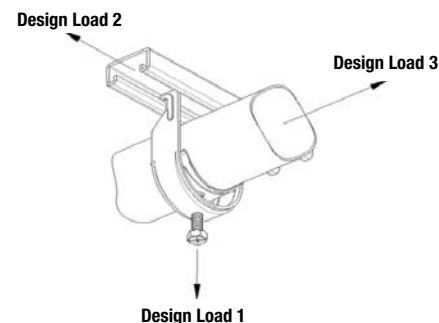

Cat. No.	EMT Trade Size (in.)	Rigid Cond. Trade Size (in.)	Cable O.D. Range (in.)	Static Load Limit (lb.) Safety Factor = 4	Qty. per Box	Wt./C lb.	Torque Value (ft.-lb.)
CPC025	1/4	1/4	0.312 - 0.600	200	100	8	35
CPC050	1/2	1/2	0.500 - 0.890	200	100	10	
CPC075	3/4	3/4	0.860 - 1.110	200	100	12	
CPC100	1	1	1.100 - 1.400	200	100	14	
CPC125	1 1/4	1 1/4	1.400 - 1.725	200	50	16	
CPC150	1 1/2	1 1/2	1.690 - 1.980	200	50	18	
CPC200	2	2	1.980 - 2.576	200	50	24	
CPC250	2 1/2	2 1/2	2.576 - 3.060	350	25	36	
CPC300	3	3	3.060 - 3.626	350	25	42	
CPC350	3 1/2	3 1/2	3.626 - 4.126	350	25	46	
CPC400	4	4	4.126 - 4.626	350	25	50	

Design Load 1 Static Load Limit lb. (kg)	Design Load 2 lb. (kg)	Design Load 3 lb. (kg)
200 (91)	50 (23)	50 (23)
200 (91)		
200 (91)		
200 (91)		
200 (91)		
200 (91)		
200 (91)		
350 (159)		
350 (159)		
350 (159)		
350 (159)		
350 (159)		
350 (159)		

#### Loc-King Cobra™

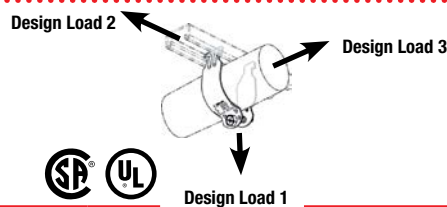

Cat. No.	EMT Trade Size (in.)	Rigid Cond. Trade Size (in.)	Cable O.D. Range (in.)	Static Load Limit (lb.) Safety Factor = 4	Qty. per Box	Wt./C lb.	Torque Value (ft.-lb.)
LKCPC050	1/2	1/2	0.650 - 0.890	100	15	10	35
LKCPC075	3/4	3/4	0.860 - 1.110	100	16	12	
LKCPC100	1	1	1.100 - 1.400	50	19	14	
LKCPC125	1 1/4	1 1/4	1.400 - 1.725	50	23	16	
LKCPC150	1 1/2	1 1/2	1.690 - 1.980	50	27	18	
LKCPC200	2	2	1.980 - 2.576	50	38	24	
LKCPC250	2 1/2	2 1/2	2.576 - 3.060	25	44	36	
LKCPC300	3	3	3.060 - 3.626	25	53	42	
LKCPC350	3 1/2	3 1/2	3.626 - 4.126	25	58	46	
LKCPC400	4	4	4.126 - 4.626	25	66	50	

Design Load 1 Static Load Limit lb. (kg)	Design Load 2 lb. (kg)	Design Load 3 lb. (kg)
350 (159)	50 (23)	50 (23)
350 (159)		
350 (159)		
350 (159)		
350 (159)		
350 (159)		
350 (159)		
450 (204)		
450 (204)		
450 (204)		
450 (204)		
450 (204)		
450 (204)		

## Pipe Straps, Pipe Clamps and Hangers

### Conduit and Cable Clamps

#### CH118 Heavy Duty Cable Clamp

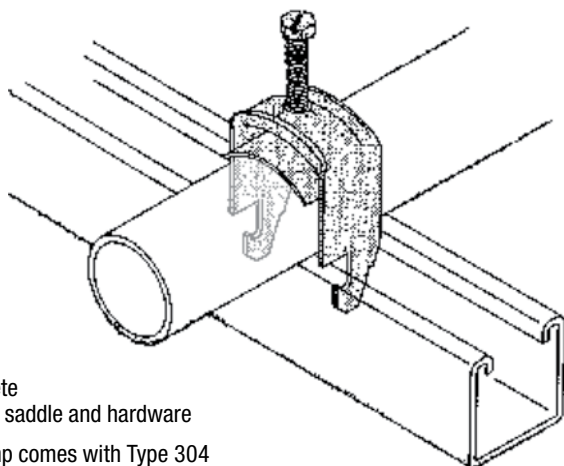

##### Standard Finishes:

Electrogalvanized (EG)

Aluminum (AL) comes complete with Stainless Steel Type 304 saddle and hardware

Stainless Steel Type 316 clamp comes with Type 304 stainless steel hardware.

Cat. No.	O.D. of cable or pipe		Rigid Cond.	EMT Cond.	WT./C. lb.
	(in.)	(mm)			
CH118-055EG	0.40-0.55	10-14	-	-	8
CH118-081EG	0.50-0.81	13-21	1/2	1/2	9
CH118-110EG	0.70-1.10	18-28	3/4	3/4	17
CH118-125EG	0.85-1.25	22-27	3/4	1	18
CH118-135EG	1.00-1.35	26-36	1	1	19
CH118-175EG	1.33-1.75	34-44	1-1/4	1-1/4	21
CH118-205EG	1.65-2.05	42-52	1-1/2	1-1/2	24
CH118-250EG	2.12-2.50	54-64	2	2	48
CH118-300EG	2.60-3.00	66-76	2-1/2	2-1/2	54
CH118-325EG	2.75-3.25	70-82	-	-	65
CH118-375EG	3.25-3.75	82-94	3	3	105
CH118-425EG	3.75-4.25	94-110	3-1/2	3-1/2	113
CH118-475EG	4.25-4.75	110-120	4	4	124

Available in double or triple configurations.

Example: Double - CH128-047EG

Triple - CH138-047EG

#### CB118 Counterbed EB118 Extended Bed DB118 Double Bed

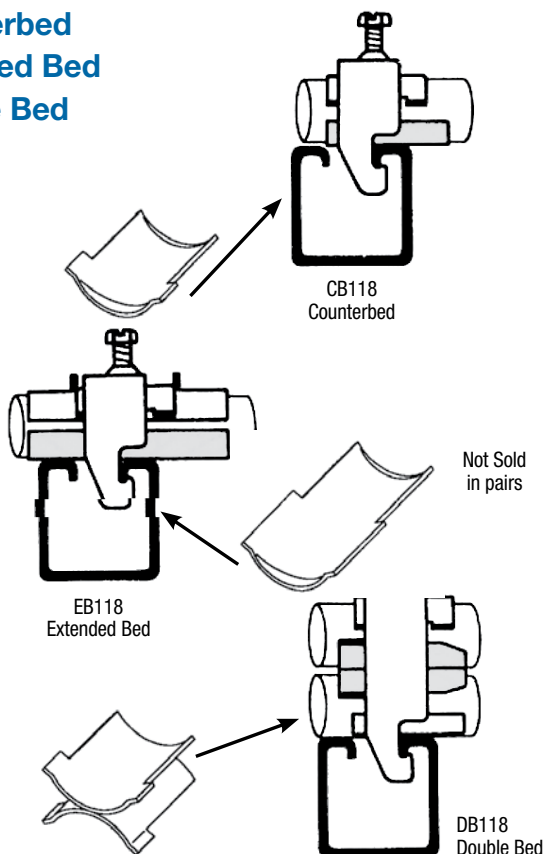

Cat. No.	Wt./C. lb.
<b>Counterbed</b>	
CB118-055PG	1
CB118-090PG	2
CB118-110PG	3-1/2
CB118-140PG	4
CB118-175PG	4-1/2
CB118-200PG	5
CB118-250PG	11
CB118-300PG	13
<b>Extended bed</b>	
EB118-047PG	4
EB118-055PG	4-1/2
EB118-090PG	6
EB118-110PG	13-1/2
EB118-140PG	16
EB118-175PG	17
EB118-200PG	20
EB118-250PG	30
EB118-300PG	38
<b>Double Bed</b>	
DB118-047PG	2
DB118-055PG	2
DB118-070PG	3

Standard Finishes - Pregalvanized (PG)

## Pipe Straps, Pipe Clamps and Hangers

### Conduit and Cable Clamps

#### A716 Snap•Guard® Cushioned Clamp Tube Series

#### P716 Snap•Guard® Cushioned Clamp Pipe Series

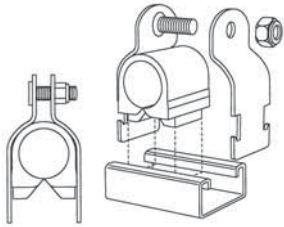

A716 / P716

- Assembly consisting of GoldGalv® finish steel clamp with bolt/locknut and cushion
- Secure pipes, tubes and hoses for fluid conductors.
- Installation is easy and requires no more time than a simple pipe clamp installation
- Cushion absorbs the shocks and associated vibrations from fluid surges in tubes, pipes and hoses
- It can handle temperatures from 149°C to -40°C (300°F to -40°F)
- Cushioned Clamp assemblies are available individually bagged

Standard Finishes GoldGalv®

Available in Stainless Steel 316 use SS316 suffix.

(i.e) A716-1SS316

Electrogalvanized (Silver) - use EG suffix.

(i.e) A716-1EG

Assembly Cat. No.	Tubing		Assembly Cat. No.	Standard Pipe		Wt./C lb.
	Tube O.D. (in.)	Wt./C lb.		Nominal Pipe Size (in.)	Std. Ctn.	
A716-1/4	1/4	10	P716-1/4	1/4	25	10
A716-3/8	3/8	14	P716-3/8	3/8		14
A716-1/2	1/2	16	P716-1/2	1/2		16
A716-5/8	5/8	16	P716-3/4	3/4		18
A716-3/4	3/4	18	P716-1	1		22
A716-7/8	7/8	18	P716-1-1/4	1-1/4		27
A716-1	1	22	P716-1-1/2	1-1/2		36
A716-1-1/8	1-1/8	24	P716-2	2		43
A716-1-1/4	1-1/4	27	P716-2-1/2	2-1/2	49	
A716-1-3/8	1-3/8	27	P716-3	3	60	
A716-1-1/2	1-1/2	36	P716-3-1/2	3-1/2	62	
A716-1-5/8	1-5/8	37	P716-4	4	94	
A716-1-3/4	1-3/4	37	-	-	10	
A716-1-7/8	1-7/8	43	-	-		
A716-2	2	43	-	-		
A716-2-1/8	2-1/8	44	-	-		
A716-2-3/8	2-3/8	49	-	-		
A716-2-5/8	2-5/8	53	-	-		
A716-3-1/8	3-1/8	62	-	-		
A716-4-1/8	4-1/8	94	-	-		

### U716 Two Hole Cushioned Clamp

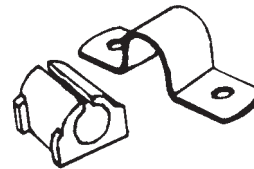

U716

- Guides, protects, and uniformly spaces line runs. Low cost, time saving method of attaching tubing and hose to equipment.
- Cushion is built to withstand the effects of most oils, chemical and industrial cleaning compounds, in temperatures from -45°C to 121°C (-50°F to 275°F). Interlock edge insures cushion remains in place.
- Attached with two standard fasteners to any flat surface, this clamp eliminates the use of special channels, providing a savings in both space requirements and cost
- Cushioned clamps reduce vibration, shock, and noise in fluid systems and eliminates electrolysis

Standard Finish – GoldGalv®

Assembly Cat. No.	Copper and Steel Tubing O.D. (in.)	Copper Water Pipe (nom.) (in.)	Normal Pipe Size (in.)	Std. Ctn.	Wt./C lb.
U716-1/4	1/4	-	-	25	3
U716-3/8	3/8	1/4	-		4
U716-1/2	1/2	3/8	1/4		6
U716-5/8	5/8	1/2	3/8		6
U716-3/4	3/4	5/8	-		7
U716-7/8	7/8	3/4	1/2		7
U716-1	1	-	-		8
U716-1-1/8	1-1/8	1	-		8
U716-1-1/4	1-1/4	-	-	10	17
U716-1-3/8	1-3/8	1-1/4	-		20
U716-1-1/2	1-1/2	-	-		22
U716-1-5/8	1-5/8	1-1/2	-		23
U716-2	2	-	-		41
U716-2-1/8	2-1/8	-	-		41
U716-2-3/8	2-3/8	-	-		44

## Pipe Straps, Pipe Clamps and Hangers

### Conduit and Cable Clamps

#### 6H Series Conduit and Pipe Hanger



6H Series



6H-B Series with Bolt and Hex Nut

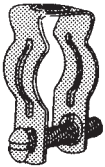

6H-TB Threaded Series



6H-T Threaded Series

#### Features

- Accommodates 1/2 in. through 4 in. EMT or rigid conduit
- Can be used for either vertical or horizontal installation
- 6HTB Series have a built-in nut so there are fewer parts to handle or drop
- Installs easily with a screwdriver

**Standard Finish - Electrogalvanized (no suffix)**

Cat. No.	Conduit Size		Wt./C. lb.
	Rigid (in.)	EMT (in.)	
6H0			5
6H0-B	3/8 - 1/2	1/2	7
6H0-T			5
6H0-TB			6
6H1			6
6H1-B	3/4	3/4	7
6H1-T			6
6H1-TB			7
6H2	1	1	7
6H2-B			9
6H2-1/2	-	1-1/4	8
6H2-1/2-B			10
6H3-SC	1-1/4	1-1/2	8
6H3-B			10
6H3-TB			10
6H4	1-1/2	-	17
6H4-B			19
6H4-TB			19
6H5	2	2	24
6H5-B			26
6H5-TB			26
6H6	2-1/2	2-1/2	28
6H6-B			30
6H7	3	3	36
6H7-B			38
6H8	3-1/2	3-1/2	39
6H8-B			41
6H9			44
6H9-B	4	4	44
			47

#### Cable Tie Mounting Bases For Framing Channel



Cat. No.	Channel Size (in.)	Maximum Tie Width Accom. (in.)	Unit Qty.	Std. Pkg.
TC5363X	1-1/2 & 1-5/8	0.301	50	250

#### Installation

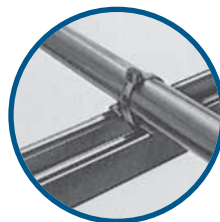
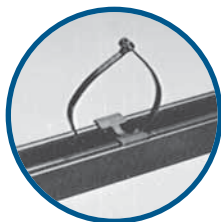

- Installs with a push and twist
- Designed for indoor or outdoor use
- Smooth design protects cable insulation
- Takes range of cable diameters

When fastening wire bundles, cables, or hoses to framing channels, you can cut costs considerably by using this mounting base. It is made of smooth, weather-resistant nylon and designed to protect cable insulation and hoses from the wear or damage that can occur with metal clamps. The mounting base may be used for both indoor or outdoor applications. It installs in the framing channel with a simple push and twist. It requires no screws, nuts or tools. The mounting base fits all 1-1/2 in. and 1-5/8 in. channels regardless of channel depth. Ty-Rap® and Ty-Fast® to be ordered separately.

## Pipe Straps, Pipe Clamps and Hangers

### Conduit and Cable Clamps

#### W716 Maple Hardwood Clamps

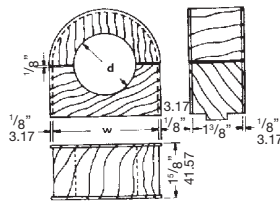
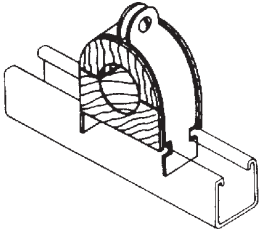

Standard Finishes -  
Pregalvanized (PG)  
Aluminum (AL)

Paraffin impregnated maple.

Cat. No.	Dimensions			
	Depth		Width	
<b>Hardwood</b>	(in.)	(mm)	(in.)	(mm)
<b>Paraffin Imp.</b>				
W716-3/4PG	3/4	19.0	2-1/8	53.9
W716-1PG	1	25.4	2-1/8	53.9
W716-1-1/4PG	1-1/4	31.7	2-5/8	66.6
W716-1-1/2PG	1-1/2	38.1	2-5/8	66.6
W716-1-3/4PG	1-3/4	44.4	3	76.2
W716-2PG	2	50.8	3-5/8	92.0
W716-2-1/4PG	2-1/4	57.1	3-5/8	92.0
W716-2-1/2PG	2-1/2	63.5	4-5/8	117.7
W716-2-3/4PG	2-3/4	69.8	4-5/8	117.7
W716-3PG	3	76.2	4-5/8	117.7
W716-4PG	4	98.0	5-5/8	143.4

Note: Holding clamp is included with W716 maple hardwood clamps.  
It is not necessary to order 701 Series separately.

#### U861, U862 and 863 Maple Cable Clamp

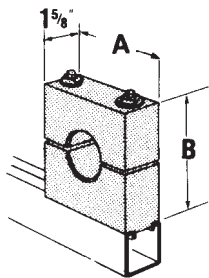

Electrogalvanized hardware included.

Custom made to your needs			
<b>Step 1</b>		<b>Cat. No.</b>	<b>Number of holes</b>
	i.e.	U861	1 hole
		U862	2 holes
		U863	3 holes
<b>Step 2</b>	Specify O.D. of cable i.e. 3/4 in. hole	U861 - 0.75	

Contact your Regional Sales Office for quotation.

#### WS716 Maple Hardwood Saddle

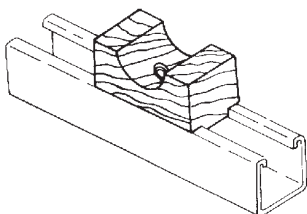

Paraffin impregnated maple.

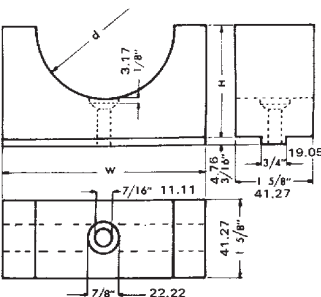

To fasten saddle, use 3/8 in. x 2 in. screw bolt.

Cat. No.	Dimensions					
	Depth		Width		Height	
<b>Hardwood</b>	(in.)	(mm)	(in.)	(mm)	(in.)	(mm)
<b>Paraffin Imp.</b>						
WS716-3/4	3/4	19.0	3	76.2	1-3/4	44.4
WS716-1	1	25.4	3	76.2	1-3/4	44.4
WS716-1-1/4	1-1/4	31.7	3-1/2	88.9	2	50.8
WS716-1-1/2	1-1/2	38.1	3-1/2	88.9	2	50.8
WS716-1-3/4	1-3/4	44.4	4	101.6	2-1/4	57.1
WS716-2	2	50.8	4	101.6	2-1/4	57.1
WS716-2-1/4	2-1/4	57.1	4-1/2	114.3	2-1/2	63.5
WS716-2-1/2	2-1/2	63.5	4-1/2	114.3	2-1/2	63.5
WS716-2-3/4	2-3/4	69.8	5	127	2-3/4	69.8
WS716-3	3	76.2	5	127	2-3/4	69.8
WS716-3-1/4	3-1/4	82.5	5-1/2	139.7	2-3/4	76.2
WS716-3-1/2	3-1/2	88.9	5-1/2	139.7	3	76.2
WS716-3-3/4	3-3/4	95.2	6	152.4	3-1/4	82.5
WS716-4	4	101.6	6	152.4	3-1/4	82.5
WS716-4-1/2	4-1/2	114.3	6-1/2	165.1	3-1/2	88.9
WS716-5	5	127	7	177.8	3-3/4	95.2
WS716-5-1/2	5-1/2	139.7	7-1/2	190.5	4	101.6
WS716-6	6	152.4	8	203.2	4-1/4	107.9
WS716-6-1/2	6-1/2	165.1	8-1/2	215.9	4-1/2	114.3
WS716-7	7	177.8	9	228.6	4-3/4	120.6

STD.  
PACK:  
10

## Pipe Straps, Pipe Clamps and Hangers

### Conduit and Cable Clamps

**AB880 3 in.  
Porcelain Saddle**

**AB881 4 in.  
Porcelain Saddle**

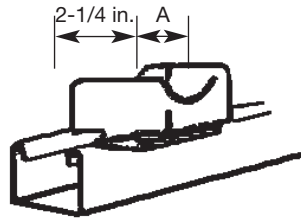

Cat. No.	A (in.)	Max. Cable Diam. (in.)	Wt./C lb.
AB880	3	3	73
AB881	4	4-1/2	104

### C755 Porcelain Cable Clamps

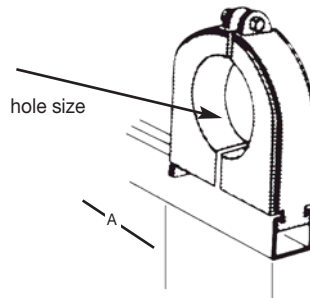

Cat. No.	Hole Size (in.)	A (in.)	Wt./C lb.
C755-1A	3/8	1-9/16	50
C755-1B	1/2	1-9/16	50
C755-1C	5/8	1-9/16	50
C755-2	3/4	2-5/32	91
C755-2A	7/8	2-5/32	90
C755-2B	1	2-5/32	85
C755-2C	1-1/8	2-5/32	82
C755-3	1-1/4	2-5/8	114
C755-3A	1-3/8	2-5/8	110
C755-3B	1-1/2	2-5/32	105
C755-3C	1-5/8	2-5/8	102
C755-4	1-3/4	3-3/4	220
C755-4A	1-7/8	3-3/4	214
C755-4B	2	3-3/4	205
C755-4C	2-1/8	3-3/4	200
C755-5	2-1/4	4-1/4	260
C755-5A	2-3/8	4-1/4	250
C755-5B	2-1/2	4-1/4	243

Cat. No.	Hole Size (in.)	A (in.)	Wt./C lb.
C755-5C	2-5/8	4-1/4	240
C755-6	2-3/4	4-3/4	250
C755-6A	2-7/8	4-3/4	240
C755-6B	3	4-3/4	230
C755-6C	3-1/8	4-3/4	220
C755-7	3-1/4	5-13/16	340
C755-7A	3-3/8	5-13/16	330
C755-7B	3-1/2	5-13/16	318
C755-7C	3-5/8	5-13/16	387
C755-8	3-3/4	6-7/8	565
C755-8A	3-7/8	6-7/8	550
C755-8B	4	6-7/8	535
C755-8C	4-1/8	6-7/8	520
C755-8D	4-1/4	6-7/8	490
C755-8E	4-3/8	6-7/8	475
C755-8F	4-1/2	6-7/8	460

**Standard Finish -**

**GoldGalv® with bronze hardware**

Also fits 1-1/2 in. wide channel.

For minimum order quantities, contact your Regional Sales Office.



## Pipe Straps, Pipe Clamps and Hangers

### Conduit and Cable Clamps

#### S716 Cushioned Strip for Isolation and Vibration Applications

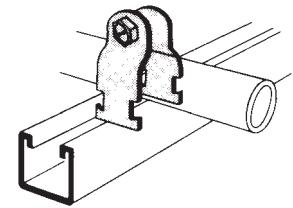
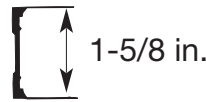
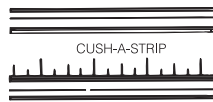
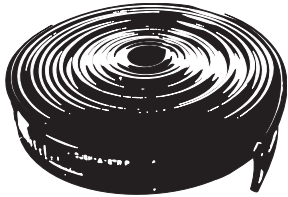

For use with 701 O.D. tubing and pipe clamp. To determine 701 clamp size add 1/4 in. to O.D. tube size to allow for the Cushioned Strip material.

1/4 in. markings for fast measuring and cutting. Measurement chart is printed on back of carton. 20 feet included in each carton.

Order 701 clamp separately.

Prevent metal to metal contact with the Cushioned Strip material. It aids in sound insulation, shock absorption and protects against corrosion, distortion and abrasion. Cushioned Strip material is designed for optimal use between -1°C and 149°C (30°F and 300°F). Cushioned Strip material combined with the Superstrut 701 pipe strap can handle clamping assignments from 1/4 in. to 6 in.

#### C708U Short Strap for Channel or Wall Mounting

Standard Finish - GoldGalv®

Example: C708U-1/2

No clearance between pipe and channel.

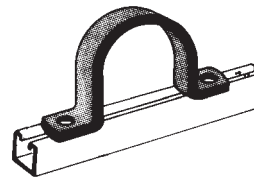
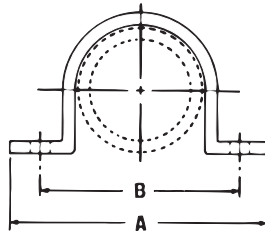

Carbon Steel

Pipe Size (in.)	A (in.)	B (in.)	Thickness (in.)	Width (in.)	Hole Size (in.)	Design Load lb.	Wt./C lb.
1/2	2-7/8	2	1/8	1-5/8	9/32	650	23
3/4	3-1/16	2-3/16					26
1	3-3/8	2-1/2					31
1-1/4	3-11/16	2-13/16					35
1-1/2	3-15/16	3-1/16	1/4		7/16	1000	39
2	5-3/4	4-1/8					94
2-1/2	6-3/16	4-9/16					114
3	6-13/16	5-3/16					133
3-1/2	7-5/16	5-11/16	1/4	7/16	1200	152	
4	7-13/16	6-3/16				176	
5	8-7/8	7-1/4				198	
6	9-15/16	8-5/16				246	

## Pipe Straps, Pipe Clamps and Hangers

### Conduit and Cable Clamps

#### C711 "J" Pipe Hanger

**Standard Finishes - GoldGalv®, ElectroGalvanized (EG)**

Complies with Specification MSS SP69, Type 5.  
Hole provided for side mounting to wall as bracket.

**Example: C711-1/2**

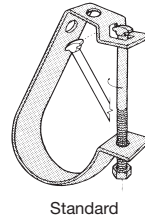

Standard

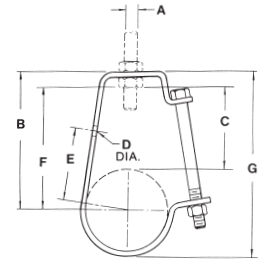

Pipe Size (in.)	A Rod Size (in.)	B (in.)	C (in.)	Overall Dimension D (in.)	E (in.)	F (in.)	Bolt Size (in.)	G	Thickness	Width (in.)	Max. Rec. Load lb.	Approx. Wt./C lb.	
1/2	3/8	2-5/8	1-3/4	7/16	1-1/2	1-15/16	1/4	3-5/32	12 ga	3/4	400	18	
3/4	3/8	2-7/8	1-7/8		1-11/16	2-1/8		3-1/2				21	
1	3/8	2-15/16	1-15/16		1-13/16	2-5/16		3-11/16				22	
1-1/4	3/8	3-1/4	2		2-1/16	2-5/8		4-1/8				25	
1-1/2	3/8	3-9/16	2-3/16		2-7/16	2-7/8		4-5/8				27	
2	3/8	3-11/16	2-1/8		2-9/16	3-1/16		5				29	
2-1/2	1/2	4-7/16	2-7/16		3-3/16	3-5/8		6				64	
3	1/2	4-13/16	2-9/16		3-1/2	4-1/16		6-21/32				72	
3-1/2	1/2	5-1/8	2-5/8	9/16	3-3/4	4-3/8	3/8	7-5/16	3/16	1-1/4	500	84	
4	5/8	6-1/8	3-3/16		4-5/8	5-3/16		8-9/16				138	
5	5/8	6-3/4	3-1/4		5-1/16	5-3/5		9-23/32				162	
6*	3/4	7-3/4	3-9/16		5-13/16	6-5/8		11-1/4				249	
8*	7/8	9-3/16	3-15/16		6-15/16	8		13-11/16				760	291

\*Hangers 6 in. and over have hole instead of slot.

#### C727 Adjustable Ring

**Standard Finish - Pregalvanized (no suffix)**

Carbon steel. For suspension of non-insulated pipe lines.  
Complies with Specification MSS SP69, Type 10.

**Example: C727-1/2**

Tube Size (in.)	Rod Size (in.)	A (in.)	B (in.)	C (in.)	Thickness	Width (in.)	Approx Max. Rec. Load	Wt./C lb.		
1/2	3/8	3-1/8	2-5/8	1-3/8	16 ga	1	400	9		
3/4		3-1/8	2-1/2	1-1/8				9		
1		3-3/8	2-5/8	1-1/8				9		
1-1/4		3-3/4	2-7/8	1-1/8				10		
1-1/2		3-7/8	2-7/8	1				11		
2		4-1/4	3	1				12		
2-1/2		5-3/4	4-1/4	1-5/8				28		
3		6	4-1/8	1-1/4				30		
3-1/2	1/2*	7-3/8	5-1/4	2-1/8	14 ga	1-3/16	600	34		
4		7-3/8	5	2-5/8				37		
5		9	6-1/8	2-1/4				1-1/4	1000	83
6		9-3/8	6-1/2	1-7/8					1250	95

\*3/8 in. nut is used when NFPA rod sizing is requested.

\*\*1/2 in. nut is used when NFPA rod sizing is requested.

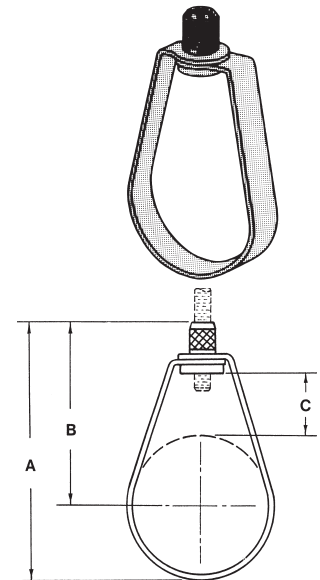

## Pipe Straps, Pipe Clamps and Hangers

### Pipe Hangers

#### C710 Adjustable Clevis Hanger

**Standard Finishes - GoldGalv®, Electrogalvanized (EG)**  
Complies with Specification MSS SP69, Type 1.

**Example: C710-1/2EG**

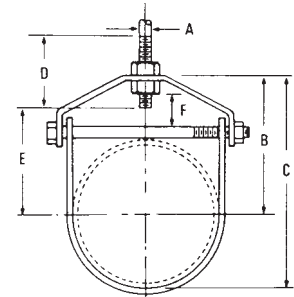

Pipe Size (in.)	Size of Steel		A (in.)	B (in.)	C (in.)	D (in.)	E (in.)	F (in.)	Max. Rec. Load, lb.	Wt./C lb.
	Upper	Lower								
1/2	1/8x1	1/8x1	3/8	1-11/16	2-1/8	2-1/2	7/8	7/16	610	30
3/4				1-7/8	2-7/16		1	1/2		32
1				2-1/8	2-13/16		1-1/4	5/8		36
1-1/4				2-9/16	3-7/16		1-3/4	7/8		42
1-1/2				3	4		2-1/8	1-1/16		55
2				3-11/16	4-7/8		2-15/16	1-5/8		60
2-1/2	3/16x1-1/4	3/16x1-1/4	1/2	4-11/16	6-1/8	3	3-13/16	2	1130	115
3				4-3/4	6-9/16		3-7/8	1-3/4		132
3-1/2				4-15/16	6-15/16		4-1/16	1-3/4		156
4				5-9/16	7-13/16		4-1/2	1-15/16		190
5				6-3/16	9		5-1/8	1-3/4		240
6				1/4x1-1/2	3/16x1-1/2		3/4	6-13/16		10-1/8
8	1/4x1-3/4	3/16x1-3/4	7/8	8-5/16	12-5/8	4-1/4	7	2-1/8	1940	500

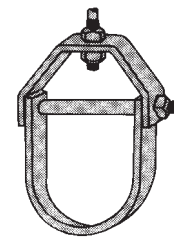

#### CL710 Light Duty Adjustable Clevis Hanger

**Standard Finishes - GoldGalv®, Bare (B), Electrogalvanized (EG), Fiberglass (FG).**

Carbon Steel

Used on non-insulated, stationary pipelines.

A lock nut above the clevis yoke is required for full rated load.

**Example: CL710-3/8B**

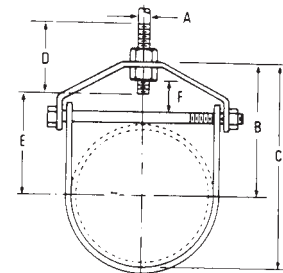

Pipe Size (in.)	Thickness of Steel		A (in.)	B (in.)	C (in.)	D (in.)	E (in.)	F (in.)	Max. Rec. Load, lb.	Wt./C lb.
	Upper	Lower								
3/8	16 ga x 7/8	16 ga x 7/8	3/8	1-7/8	2-3/16	2-1/2	1-1/4	9/16	150	12
1/2				1-3/4	2-3/16	2-1/2	1-1/8	9/16		13
3/4				1-7/8	2-1/4	2-1/2	1-1/4	1/2		15
1				2-3/16	2-3/4	2-1/2	1-1/2	3/4		18
1-1/4				2-5/8	3-3/8	2-1/2	1-3/4	1		20
1-1/2				3	3-7/8	2-1/2	2-1/4	1-3/16		30
2	13 ga x 7/8	13 ga x 7/8	3/8	3-9/16	4-3/4	2-1/2	2-13/16	1-5/8	250	38
2-1/2				4	5-1/2	3	3-1/4	1-3/8		80
3				4-9/16	6-1/2	3	3-9/16	1-1/2		89
3-1/2				5	7	3	4-1/8	1-3/4		106
4				5-1/4	7-1/2	3-1/2	4-1/4	1-7/8		146
6				1/4x1-1/2	3/16x1-1/2	3/4	6-13/16	10-1/8		4
8	1/4x1-3/4	3/16x1-3/4	7/8	8-5/16	12-5/8	4-1/4	7	2-1/8	1940	500



## Pipe Straps, Pipe Clamps and Hangers

### Pipe Hangers

#### M718 Split Pipe Ring

Standard Finishes - Bare (B) or Electrogalvanized (EG)

Malleable iron.

For suspension of non-insulated, stationary pipelines.

Example: M718-3/8B

Pipe Size (in.)	A (in.)	B (in.)	Max. Rec. Load, lb.	Wt./C Approx.
3/8	3/8	13/16	180	10
1/2		7/8		13
3/4		1		14
1		1-1/8		16
1-1/4		1-5/16		22
1-1/2		1-7/16		24
2	1/2	1-11/16	300	31
2-1/2		2-1/8		60
3		2-7/16		74
4		2-15/16		116

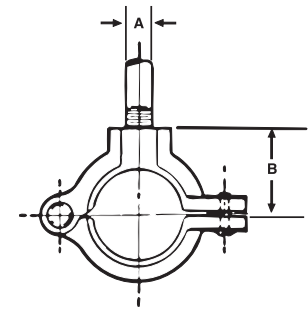
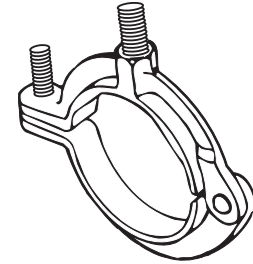

#### C725 Medium Pipe Clamp

Standard Finishes - GoldGalv®, Bare (B), Electrogalvanized (EG)

Carbon steel. For suspension of pipelines where little or no insulation is required.

Complies with Specification MSS SP69, Type 23.

Example: C725-1/2B

Pipe Size (in.)	B (in.)	C (in.)	D (in.)	E (in.)	F (in.)	H (in.)	S (in.)	Max. Rec. Load, lb.	Wt./C Approx.
1/2	1	7/16	1-5/8	1	5/16	1-1/2	1/8 x 1	500	29
3/4	1-1/8		1-3/4	1-1/4		1-3/4			32
1	1-1/4		1-13/16	1-1/4		1-13/16			33
1-1/4	1-7/16	1/2	2	1-7/16	1/2	2	1/4 x 1	715	38
1-1/2	1-5/8		2-1/16	1-1/2		2-1/4			39
2	2-1/8	9/16	3-1/8	2-1/4	1/2	3	1/4 x 1	1040	117
2-1/2	2-5/16		3-5/16	2-1/2		3-1/4			128
3	2-3/4		3-3/4	2-3/4		3-5/8			140
3-1/2	3-7/8	5/8	3-3/4	3	5/8	3-7/8	1/4 x 1-1/4	1615	145
4	3-5/16	3/4	4-1/4	3-5/16		4-1/4			238
6	4-7/8	7/8	5-7/8	5	3/4	5-3/4	3/8 x 1-1/2	2490	542
8	6	1	7	6-1/8	3/4	6-7/8			651
10	7-5/16		8-9/16	7-7/16	7/8	8-7/16	1360		
12	8-1/4		9-9/16	8-7/16	7/8	9-3/8	1605		

Based on the allowable stresses shown in ANSI Code for pressure piping.

For sizes 14 to 24, contact your Regional Sales Office.

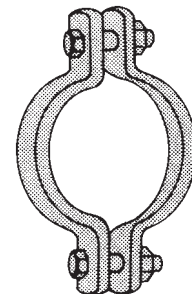
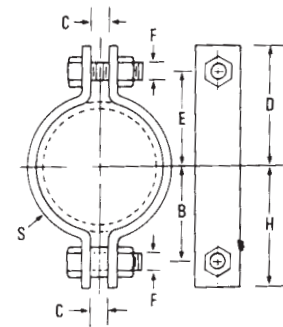

## Pipe Straps, Pipe Clamps and Hangers

### Pipe Hangers

#### C720 Riser Clamp

**Standard Finishes - GoldGalv®, Bare (B)**

Available in sizes 1/2 in. through 10 in.

Complies with Specification MSS SP69, Type 8.

**Example: C720-1-1/2B**

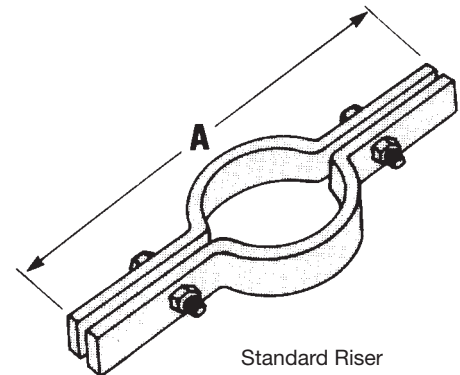

Standard Riser

Pipe Size (in.)	A (in.)	Thickness (in.)	Width (in.)	Bolt (in.)	Max. Rec. Load, lb.	Wt./Ea. Approx.			
1/2	9-1/8	3/16	1	3/8 x 1-1/2	220	1.01			
3/4	9-1/4					1.06			
1	9-5/8					1.07			
1-1/4	9-7/8					1.12			
1-1/2	10					1.20			
2	10-1/2					1.25			
2-1/2	11-1/16	1/4	1-1/2	1/2 x 1-3/4	1500	3.44			
3	11-13/16					3.65			
3-1/2	13					2.12			
4	13-1/2					2.22			
5	14					2.50			
6	15-3/16					2.50			
8	19					3/8	5/8 x 2-1/2	2500	7.24

#### C726 Double Bolt Pipe Clamp

**Standard Finish - Bare (B)**

Carbon Steel. For the suspension of insulated pipelines. Normally used with weldless eye nut.

**Example: C726-1/2B**



Pipe Size (in.)	B (in.)	C (in.)	D (in.)	E (in.)	F (in.)	H (in.)	S (in.)	Max. Rec. Load, lb.	Wt./C Approx.				
3/4	1-1/16	5/8	3-3/16	2-1/2	3/8	1-11/16	3/16 x 1	950	66				
1	1-1/2		3-3/4	2-1/2		2-1/16			69				
1-1/4	1-1/2	3/4	3-11/16	2-7/8	5/8	2-1/4	1/4 x 1-1/4	1545	75				
1-1/2	1-13/16		4-7/8	3-3/4		2-13/16			181				
2	2-1/4		5-11/16	4-11/16		3-3/16			200				
2-1/2	2-5/8		6-1/2	5-3/8		3-1/2			232				
3	2-3/4	1-1/16	6-7/8	6	3/4	3-3/4	3/8 x 2	2500	258				
3-1/2	3		7-1/16	6-3/16		4			264				
4	3-3/8		7-5/8	6-1/2		4-1/2			750				
5	3-15/16		8-1/8	7		5			813				
6	4-3/4		1-7/16	9-15/16		8-9/16			1	6-1/8	3/8 x 2-1/2	2865	1311
8	5-3/4			10-15/16		9-9/16				7-1/8			1467

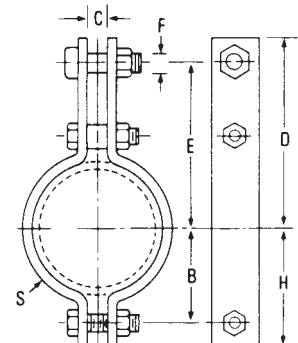

## Pipe Straps, Pipe Clamps and Hangers

### Seismic Bracing

#### C749N Seismic Brace

Standard Finish - GoldGalv®

1650 lb. load  
safety factor 3  
Wt./C 61 lb.

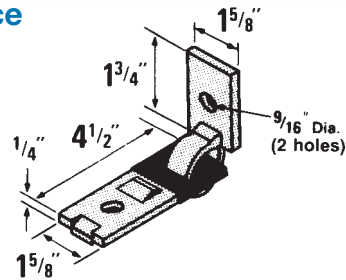

#### C749N-5/8 Seismic Brace

Standard Finish - GoldGalv®

1650 lb. load  
safety factor 3  
Wt./C 56 lb.

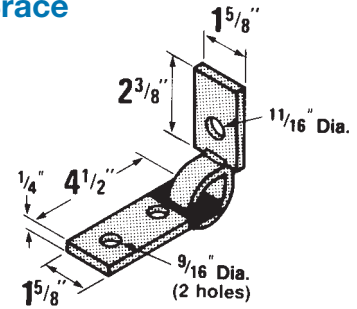

#### C749N-7/8 Seismic Brace

Standard Finish - GoldGalv®

1650 lb. load  
safety factor 3  
Wt./C 74 lb.

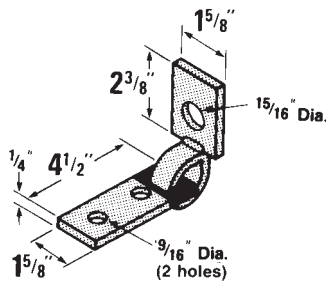

#### C749N-1 1/8 Seismic Brace

Standard Finish - GoldGalv®

1650 lb. load  
safety factor 3  
Wt./C 72 lb.

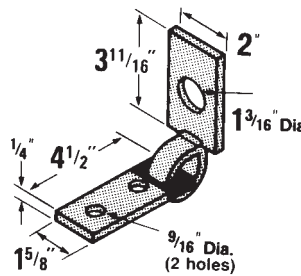

#### ES142

Standard Finish - GoldGalv®

Seismic bracing rod  
stiffener connector.  
Wt./C 21 lb.

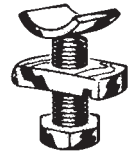

Cat. No.	Bolt Dia.	Wt./C lb.
ES-142-1/2 x 1-1/2	1/2	21

All braces have plastisol coating on the flat member.

Plastisol insulates against vibration noise transmission and eliminates rattle at the connection points.

## Hanger Accessories

Other products available. Contact your Regional Sales Office.

### C704A

Offset J-Hook



Sizes 1/2 in. thru 3 in. IPS

### M732H

I-Beam w/Eye Nut



MSS SP69 Type 28

### M732 / M732 Ext

I-Beam Clamp w/Swing Nut



Sizes 3/8 in. thru 7/8 in. Rod  
MSS SP69 Type 30

### C736

Light Welded Steel Bracket



Max. Load 750 Lb.  
MSS SP69 Type 31

### C739M

Medium Welded Steel Bracket



Max. Load 1500 Lb.  
MSS SP69 Type 32

### C739H

Heavy Welded Steel Bracket



Max. Load 3000 Lb.  
MSS SP69 Type 33

### M750

Side Beam Bracket



Sizes 3/8 in. thru 7/8 in. Rod  
MSS SP69 Type 34

### C785A

Pipe Stanchion Saddle



Sizes 4 in. thru 36 in. IPS  
MSS SP69 Type 37

### C786

Adj. Pipe Saddle Support



Sizes 2-1/2 in. thru 36 in. IPS  
MSS SP69 Type 38

### C789

Steel Pipe Covering Protection Saddle



MSS SP69 Type 39

### C790

Insulation Protection Shield for PVC coated pipe lines and insulated copper tubing

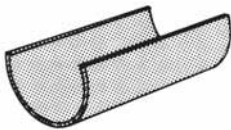

Sizes 3/4 in. thru 12 in. IPS  
MSS SP69 Type 40

### RC729A

Single Pipe Roll



Sizes 1 in. thru 24 in. IPS  
MSS SP69 Type 41

### C729

Adj. Roller Hanger



Sizes 1 in. thru 20 in. IPS  
MSS SP69 Type 43

### S730C

Pipe Roll + Base

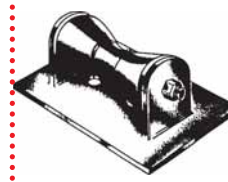

MSS SP69 Type 44

### S730D

Adj. Pipe Roll & Base



MSS SP69 Type 46

### C769

Top I-Beam Clamp

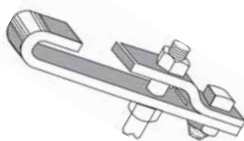

Sizes 3/4 in. thru 7/8 in. Rod  
MSS SP69 Type 25

### C755 T / C757 T

Center I-Beam Clamp

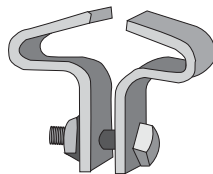

MSS SP69 Type 21

### C780

Weld attachment as shown or inverted less bolt

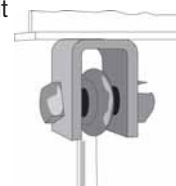

MSS SP69 Type 22

### M778

Top Beam C-Clamp

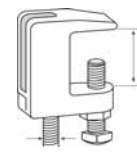

Sizes 3/8 in. thru 3/4 in. Rod  
MSS SP69 Type 19

### M777

Junior Top Beam C-Clamp

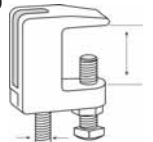

Sizes 3/8 in. thru 1/2 in. Rod  
MSS SP69 Type 18

## Surface Raceway and Lighting Systems

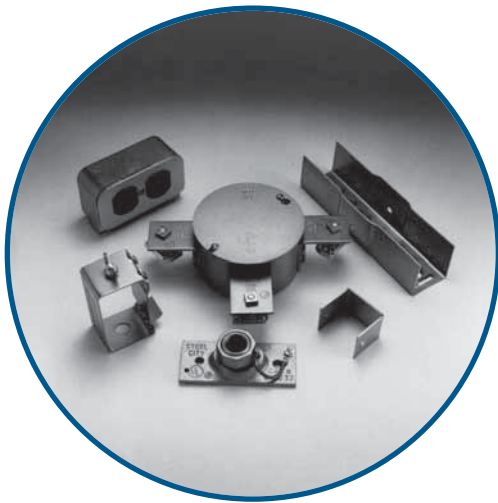

### Material

Superstrut® electrical raceway, fixture hanging channel, closure strip and accessories are manufactured from hot rolled strip steel. Standard finish for the accessories is GoldGalv®.

### Design Data

Deflections at various hanger rod spacings for raceway channels based on 40 to 45 lb. per fixture.

Deflection			
Channel	at 10 ft. (in.)	at 12 ft. (in.)	at 14 ft. (in.)
A1200	1/4	1/2	3/4
C1200			*
A1400	3/8	3/4	*

Deflection			
Channel	at 6 ft. (in.)	at 7 ft. (in.)	at 9 ft. (in.)
B1200	3/8	9/16	5/8
B1400	1	1/2	*

\*Not recommended for this spacing.

### Electrical Raceway

Superstrut channel together with snap-in closure strip is listed by Underwriters Laboratories as a surface metal raceway. Other accessories listed by Underwriters Laboratories are identified on the drawings.

Wire Size AWG	Maximum Number of Wires							
	Raceway							
	With or Without KO A1200 A1400		B1200 B1400		C1200		E1200 H1200	
	A	B	A	B	A	B	A	B
14	6	10	4	6	5	10	6	10
12	6	10	3	6	4	10	6	10
10	5	8			4	6	5	8
8	4	6			3	4	4	6
6	2	3			2	2	2	3

COLUMN A: Suitable for number of wires indicated when used as a raceway. Also suitable for number of wires indicated when installed to support and supply electrical fixtures when raceway wiring is suitable for not less than 75°C.

By providing clearance between fixture and raceway of not less than 1/2 in., where suitable for 60°C may be used.

COLUMN B: Suitable for number of wires indicated when used as a raceway. Also suitable for number of wires indicated when installed to support electrical fixtures when clearance of not less than 1/8 in. is provided between raceway and fixture and when wiring is suitable for 75°C.

Applicable Channels	
A1200	B1200
A1200-KO	B1400
A1400	C1200
A1400-KO	E1200
	H1200





## Surface Raceway and Lighting Systems

### Fixture Fittings

#### 802 Raceway Joiner With Reinforcing Plate

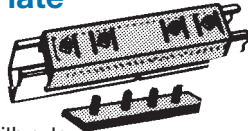

Furnished complete with nuts.

Cat. No.	For Channel	Wt./C lb.
A802EG	A Series	158
B802EG	B Series	112
E802EG	E Series	170
H802	H Series	182

#### 822 Raceway Joiner & Seal

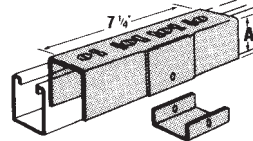

Furnished complete with 1/4 in. x 5/8 in. machine screws and AB100-1/4 nuts.

Cat. No.	A (in.)	For Channel	Wt./C lb.
A822	1-11/16	A Series	75
B822	7/8	B Series	56

#### A213 Inside Joiner

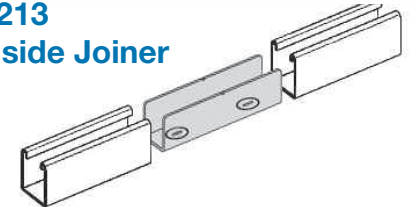

For A1200 Series channel.  
Only available in GoldGalv® finish.

#### 805 End Cap With Knockout

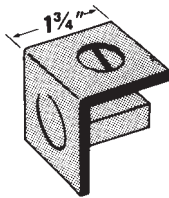

KO for 1/2 in. conduit. Furnished complete with 1/4 in. x 5/8 in. flat head machine screw and AB100-1/4 nut.

Cat. No.	For Channel	Wt./C lb.
A805EG	A Series	21
H805EG	H Series	31

#### 809 Tapped End Cap

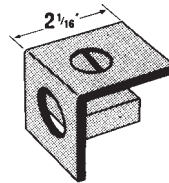

12 ga. steel. For 3/4 in. or 1 in. conduit. Furnished complete with 1/4 in. x 5/8 in. flat head machine screw and AB100-1/4 nut.

Rod Size	For Channel	Wt./C lb.
A809-3/4EG	A Series	2
E809-3/4EG	E Series	26

#### A853 Channel Hanger

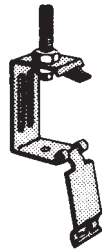

Use hanger rod 3/8 in. or 1/2 in. Use with A, AR, B, BR or C Series single channel.  
Wt./C 25 lb.

#### A853L Channel Hanger - Long

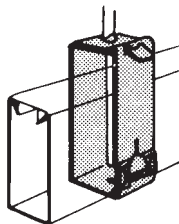

Long type for all Series channel.  
Wt./C 48 lb.

#### A854 Channel Hanger

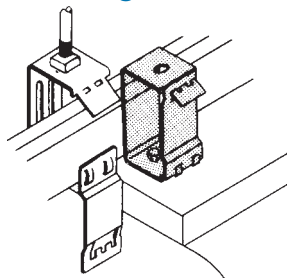

Illustration showing A854 with nut and bolt furnished to attach to fluorescent fixture.  
Use with A, B, C or D Series channel.  
Wt./C 34 lb.

#### A854L Channel Hanger - Long

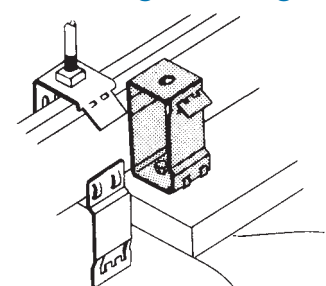

Illustration showing A854L with nut and bolt furnished to attach to fluorescent fixture.  
Use with E and H Series channel as well as A, B, C or D Series channel.  
Wt./C 51 lb.

## Surface Raceway and Lighting Systems

### Fixture Fittings

#### AB844PGC

Steel Closure Strip

#### AB844PC

Plastic Closure Strip Colour: Gold

#### AB844PCGY

Plastic Closure Strip Colour: Grey

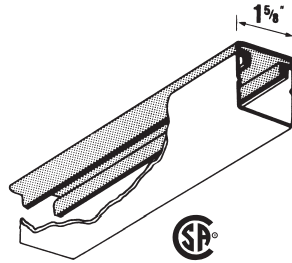

- When used as a raceway, channel is normally installed with the slot up. After wiring has been completed the closure strip is installed.
- For all channels
- Standard length: 10 ft.

#### AB803

Cast Conduit Connector

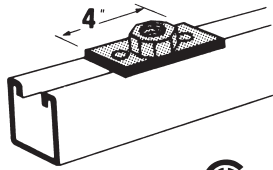

To connect 1/2 in. or 3/4 in. conduit to raceway channel. Furnished complete with stud nuts and hex nuts. Part has removable bushing to increase size from 1/2 in. to 3/4 in.

Wt./C 60 lb.

#### AB815

Swing Connector

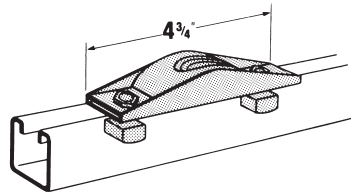

Nuts and bolts to clamp to channel is included. For 1/2 in. or 3/4 in. conduit.

Wt./C 95 lb.

#### AB885

15° Swivel

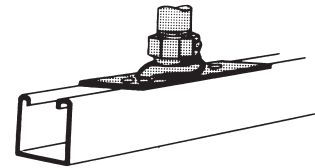

Nuts and bolts to clamp to channel included. For 1/2 in. or 3/4 in. conduit.

Wt./C 25 lb.

#### AB867 Spacer

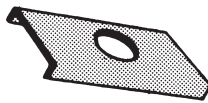

For use with AB866 wiring stud nuts.

Wt./C 24 lb.

#### AB866 Wiring Stud Nut

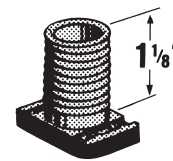

1/2 in. Pipe thread

Wt./C 21 lb.

#### 811 Stud Nut

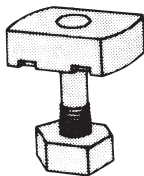

#### 812 Stud Nut

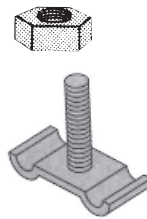

For attaching fixture to slot down channel or to slot up knockouts. Specify length. Hex nut included.

#### AB868 Fiber Retainer for Cables Until Closure Strip is Installed

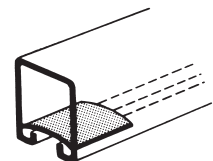
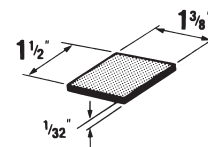

Wt./C 3 lb.

STD.  
PACK:  
100

Cat. No.	For Channel	Wt./C lb.
811-1STR	1/4 x 1	8
811-2STR	1/4 x 1-1/4	9

Cat. No.	For Channel	Wt./C lb.
812-1EG	1/4 x 1	6

## Surface Raceway and Lighting Systems

### Kindorf® Channel Boxes and Receptacles

**G2000**

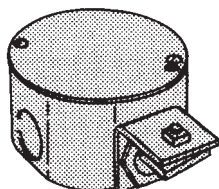

Finish - GoldGalv® Wt./C 110 lb.

**G2001**

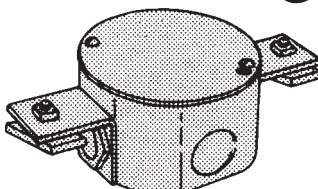

Finish - GoldGalv® Wt./C 120 lb.

**G2002**

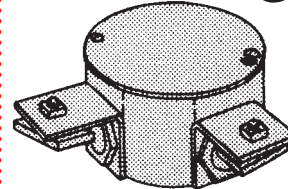

Finish - GoldGalv® Wt./C 120 lb.

**G2003**

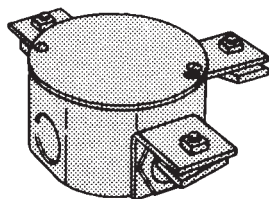

Finish - GoldGalv® Wt./C 130 lb.

**G2004**

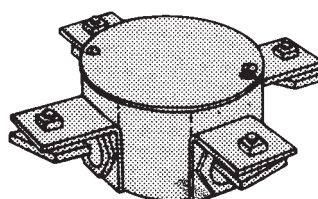

Finish - GoldGalv® Wt./C 140 lb.

**G1038 Duplex Outlet**

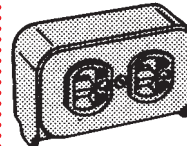

Complete unit including housing, standard DUPLEX 3-wire, 15 Amp., 125 volt, ground receptacle and cover plate.

Finish - GoldGalv® Wt./C 55 lb.

**G1038A Single Outlet**

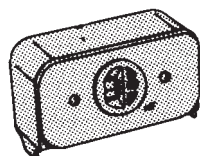

Complete unit including housing, standard SINGLE 3-wire, 15 Amp., 125 volt, ground receptacle and cover plate.

Finish - GoldGalv® Wt./C 50 lb.

**G1038D Raceway Outlet**



Complete unit including housing, duplex, 3-wire, 15 amp., 277 volt-twistlock receptacle and cover plate.

Finish - GoldGalv® Wt./C 60 lb.

**G1038E Raceway Outlet**

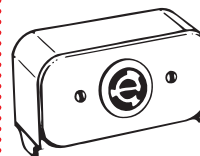

Complete unit including housing, single, 3-wire, 15 amp., 277 volt-twistlock receptacle and cover plate.

Finish - GoldGalv® Wt./C 50 lb.

**G1038B Housing Only**

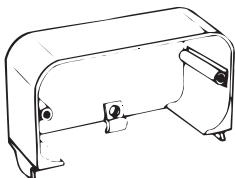

Finish - GoldGalv® Wt./C 25 lb.

**G1038C Duplex Cover Plate**

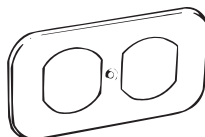

Finish - GoldGalv® Wt./C 12 lb.

**G1038CA Single Cover Plate**

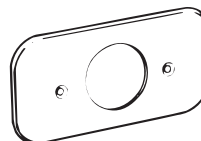

Size of opening: 1.391 diameter

Finish - GoldGalv® Wt./C 14 lb.

**G1038CX Blank Cover Plate**

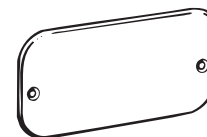

Finish - GoldGalv® Wt./C 15 lb.

## Surface Raceway and Lighting Systems

### Kindorf® Fixture Accessories

#### G1017 Mercury Vapor Hanger

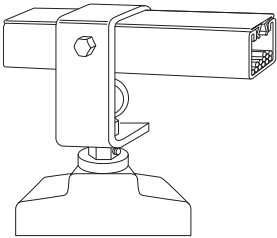

##### Finish - GoldGalv®

To support high or low bay mercury vapor or heavy incandescent fixtures from raceway channels. Permits plug-in connections with G-1038 raceway outlets.

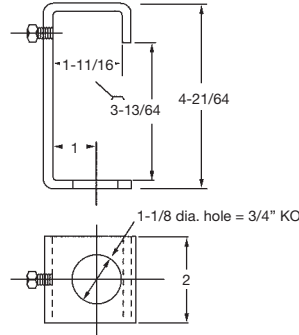

#### G972HB1/2 Steel Fixture Hanger Adapter

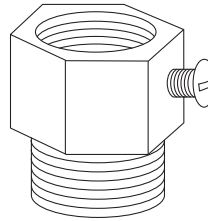

##### Finish - GoldGalv®

The hanger adapter securely mounts the fixture hanger or box to the channel through the 1/2 in. KO in the base. No special tools are needed for installation of fittings and fixtures.

Superstrut® channels, with 1/2 in. KO's every 6 in., hangs and feeds the fixtures thereby simplifying installation.

Wt./C 17 lb.

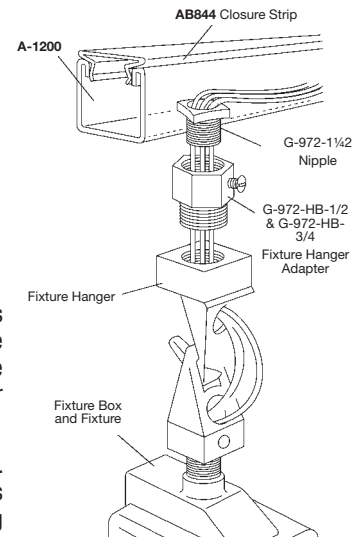

Used with Channel	Depth (in.)	Wt./C lb.
A-1200	4-1/4	76

### Electrical Applications

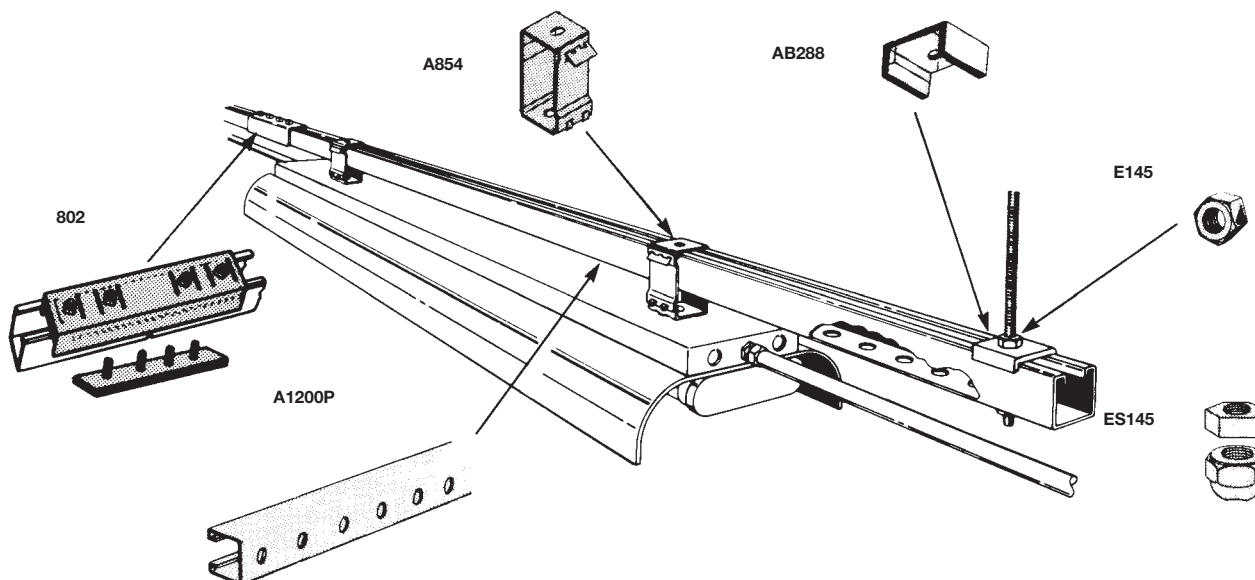

## Surface Raceway and Lighting Systems

### Electrical Applications

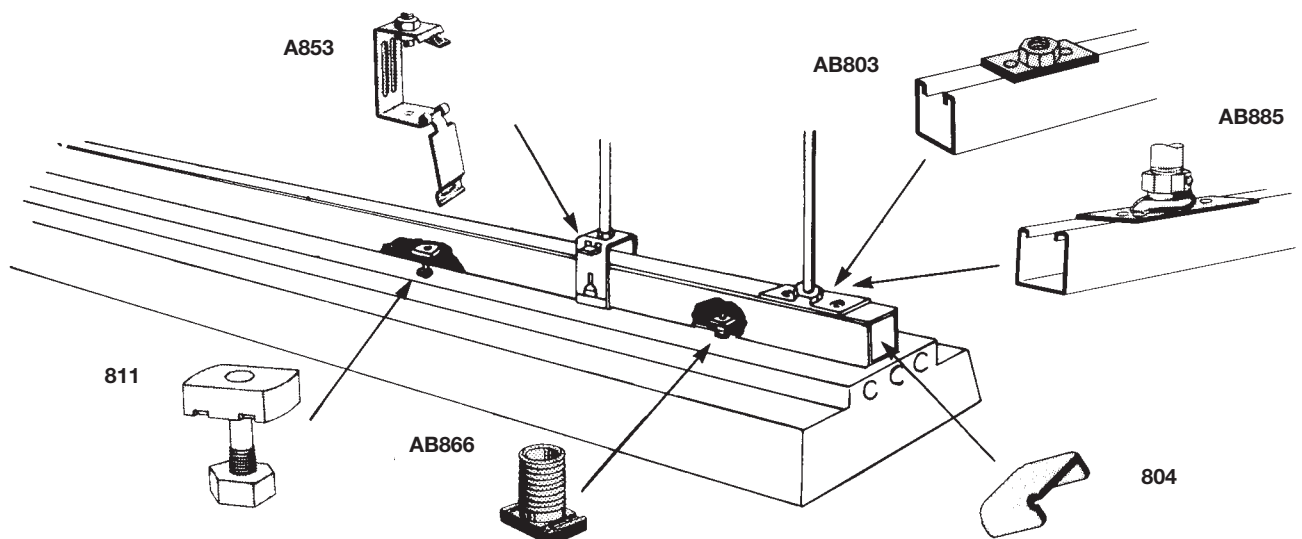
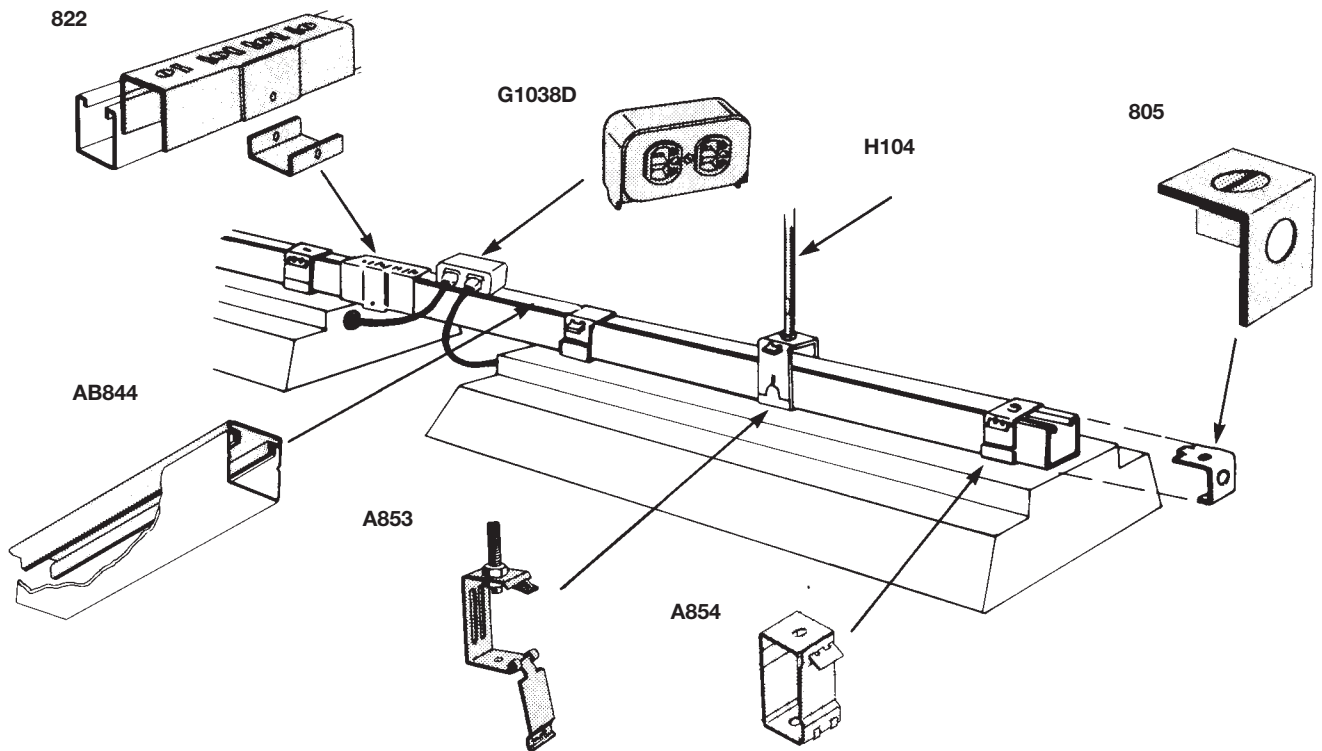

## Surface Raceway and Lighting Systems ..... Electrical Applications

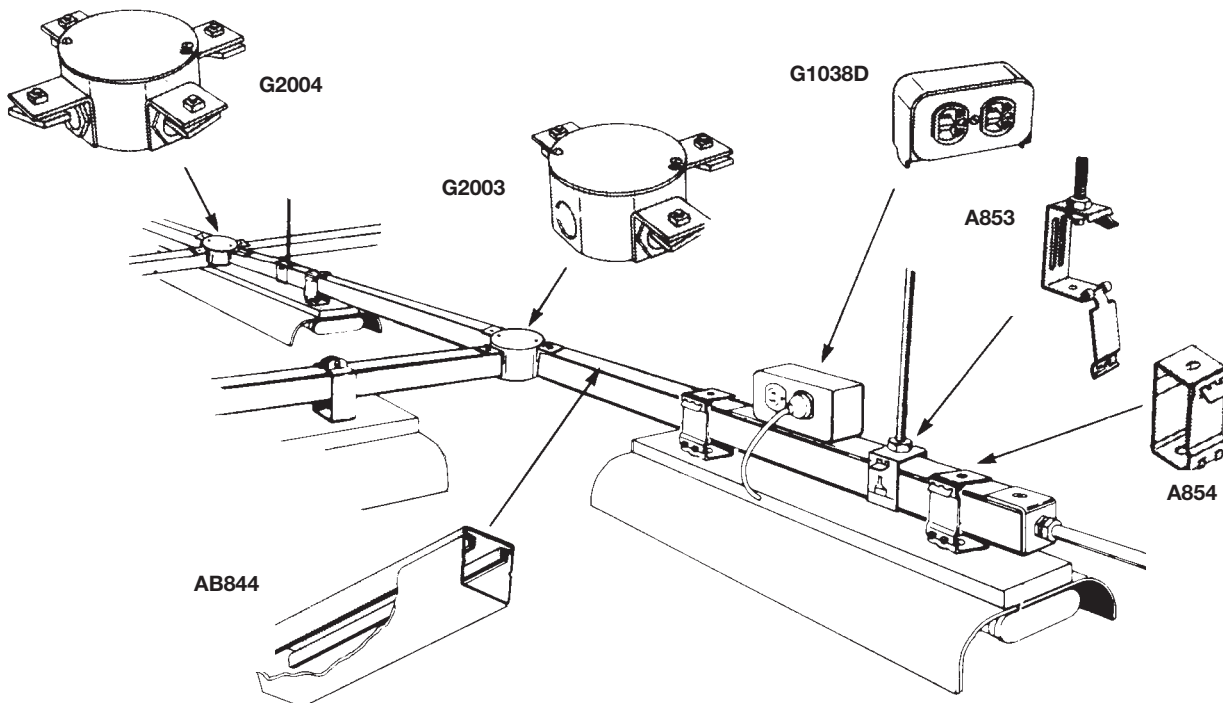
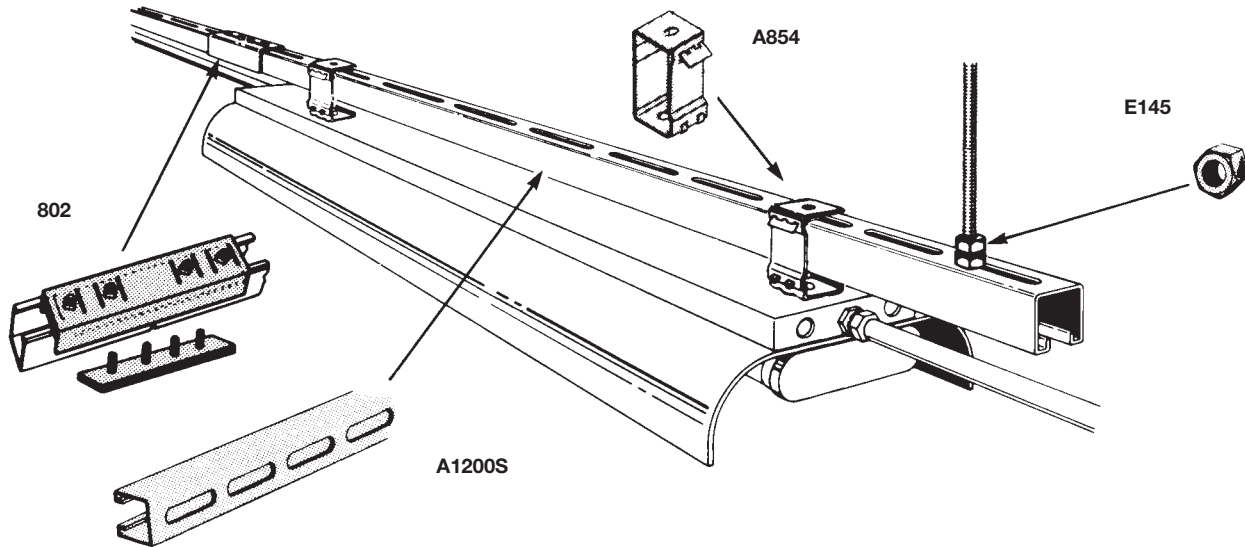

## Right Angle Slotted Metal Framing

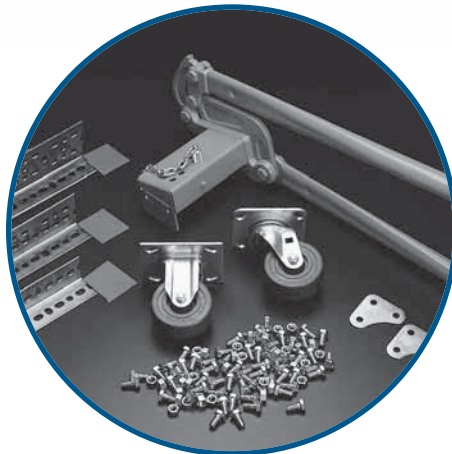

### Create the support framing you need

Right Angle Metal Framing is manufactured from commercial quality steel in three different sizes. The small sizes are 14 ga. steel, the larger is 12 ga. steel. With this offering, an endless variety of metal framing requirements can be met, from lightweight supporting needs to larger shelving for inventory storage.

One of the legs on all sizes is 1-5/8 in. wide, while the other is either 1-5/8 in., 2-3/8 in. or 3-1/8 in. long. Depending on the frame requirements, a single size can be utilized throughout, or the sizes can be interchanged to get the most efficient usage from the material.

**This section will serve as a guide to plan and build your structure.**

### Installation time is reduced - inventory space is minimal

Scribe marks are placed every 3/4 in. which saves planning, layout and cutting time and ensures accuracy. The exclusive slot and hole pattern, repeated every 3 in., is scientifically designed for ease of assembly and rigidity. No welding is necessary, no holes to drill. A 9/16 in. wrench is the only tool required for assembly. The proper nuts and bolts are included with the material to ensure fast and easy erection.

Right angle metal framing is packaged in 10' and 12' lengths to minimize cut offs and ensure maximum use of material.

120 feet, 10, 12 foot lengths of right angle metal framing take up the same amount of space as one 2x4. A standard package includes 5 pieces to a bundle, significantly reducing handling and storage space.

The importance of cutting right angle easily, quickly and accurately is the key to time saving assembly. The portable cutter provides these advantages and makes layout and erection of any structure a "light-work" job.

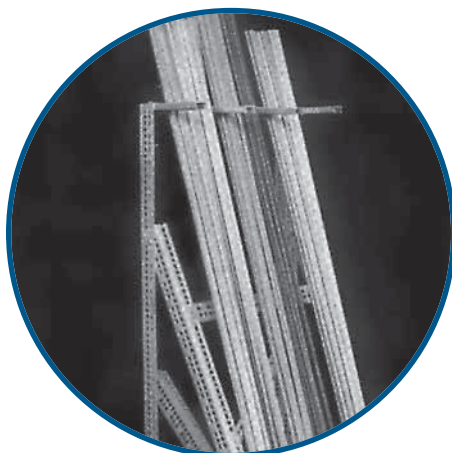
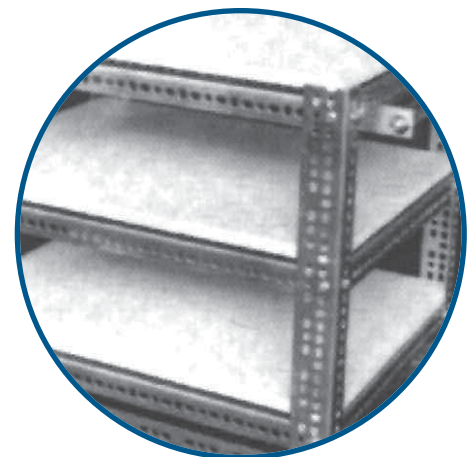

### Finish is designed for long lasting durability

The standard GoldGalv® hardware finish is applied to all Right Angle Metal Framing after rolling and punching of the holes. This provides you with a number of benefits. First, raw ends resulting from cuts will be protected by the sacrificial quality of zinc. Second, the edges of all holes are protected against formation of rust, to provide a call back free installation. Third, the electrogalvanizing provides an excellent bonding surface for paint if desired for aesthetic reasons.

Note: Product is also available in pregalvanized (PG) sections.

FLEXIBILITY

SIMPLICITY

ECONOMY

## Right Angle Slotted Metal Framing

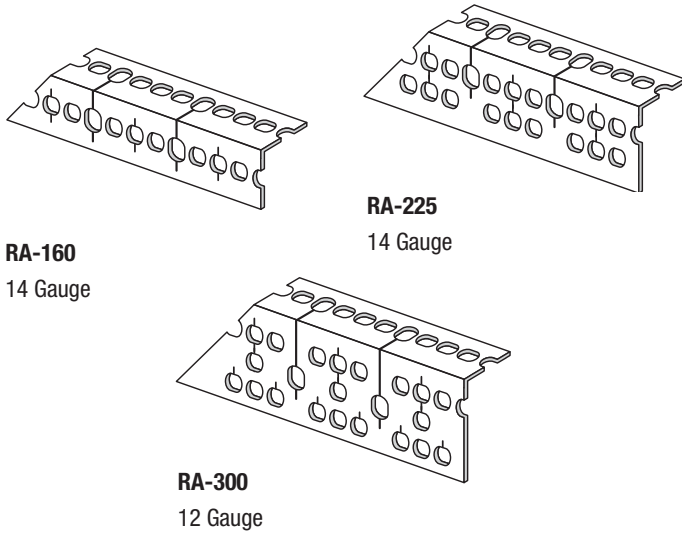

### Extra Nuts and Bolts

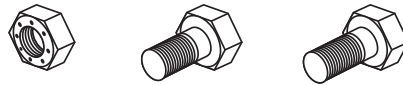

Cat. No.	Length ft.	No. of ft./per Pkg.
RA-160-10	10	50
RA-160-12	12	60
RA-225-10	10	50
RA-225-12	12	60
RA-300-10	10	50
RA-300-12	12	60

Each package includes 36 nuts and bolts.

Cat. No.	Package 100 Sets	Std. Ctn.
RA-BN-5/8	2-3/8 in. - 16 x 1-5/8 in.	100
Use with RA-160 & RA-225		
RA-BN-3/4	2-3/8 in. - 16 x 3/4 in.	100
Use with RA-300		

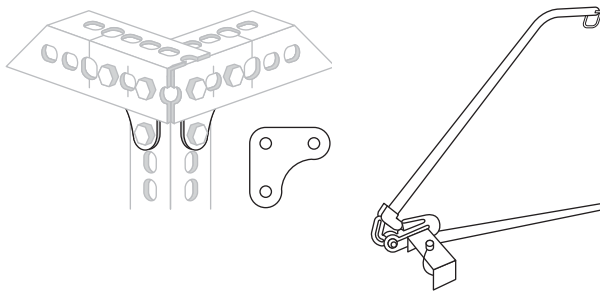

**RA-GP**  
Gusset Plate  
For extra rigid assembly

**RA-C**  
Portable Cutter

Cat. No.	Package	Std. Ctn.
RA-GP	25	100
RA-RC	2	2
RA-SC	2	2
RA-C	1	1

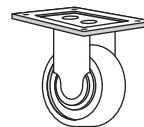

**RA-RC**



**RA-SC**

Rigid & Swivel Casters.  
Hard rubber composition 3-1/2 in. dia.  
with load rating of 225 lb. per wheel.



## Engineering Data & Specifications

### Design Data – Metal Framing Channel

**TABLE 1**  
Elements of Sections  
Properties for Design

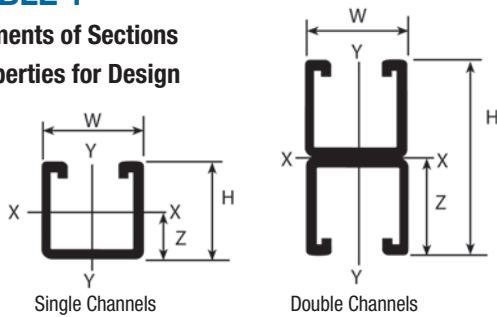

**Nominal Thickness (inches)**  
12 ga = 0.105  
14 ga = 0.075  
16 ga = 0.060

LEGEND	
<b>I</b>	Moment of inertia
<b>S</b>	Section Modulus
<b>r</b>	Radius of Gyration
<b>Z</b>	Nominal Axis
<b>A</b>	Area

Section Member	WT. lb./ft.	H (in.)	W (in.)	A (in.) <sup>2</sup>	X-X AXIS				Y-Y AXIS		
					I (in.) <sup>4</sup>	S (in.) <sup>3</sup>	r (in.)	Z (in.)	I (in.) <sup>4</sup>	S (in.) <sup>3</sup>	r (in.)
<b>Single Channel</b>											
A1200	1.90	1.625	1.625	0.557	0.192	0.212	0.587	0.719	0.237	0.292	0.652
B1200	1.28	0.813	1.625	0.381	0.031	0.063	0.283	0.331	0.137	0.168	0.600
C1200	1.70	1.375	1.625	0.500	0.121	0.155	0.492	0.595	0.205	0.252	0.640
D1200	1.44	1.000	1.625	0.424	0.053	0.092	0.356	0.403	0.159	0.196	0.616
E1200	2.47	2.438	1.625	0.726	0.529	0.399	0.853	1.112	0.335	0.413	0.679
H1200	3.05	3.250	1.625	0.897	1.100	0.635	1.107	1.507	0.436	0.536	0.697
A1400	1.40	1.625	1.625	0.401	0.134	0.146	0.577	0.707	0.184	0.226	0.677
B1400	0.97	0.813	1.625	0.280	0.024	0.051	0.295	0.338	0.103	0.127	0.607
<b>Double Channel</b>											
A1202	3.80	3.250	1.625	1.114	0.948	0.583	0.992	1.625	0.474	0.584	0.652
B1202	2.56	1.626	1.625	0.762	0.147	0.181	0.439	0.813	0.274	0.337	0.600
C1202	3.40	2.750	1.625	1.000	0.595	0.433	0.772	1.375	0.409	0.504	0.640
D1202	2.88	2.000	1.625	0.847	0.257	0.257	0.552	1.090	0.319	0.393	0.616
E1202	4.94	4.876	1.625	1.450	2.854	1.171	1.402	2.438	0.672	0.827	0.680
H1202	6.10	6.500	1.625	1.794	6.273	1.930	1.870	3.250	0.871	1.072	0.697
A1402	2.80	3.250	1.625	0.801	0.668	0.411	0.913	1.625	0.367	0.452	0.677
B1402	1.94	1.626	1.625	0.560	0.112	0.138	0.447	0.813	0.206	0.254	0.607

**TABLE 2**  
Maximum Pullout and Slip Loads for Steel Channel and Channel Nuts

Channel Nuts Size / Thread	Channel All Series	Pull Out Strength		Slip Resistance		Torque	
		lb.	kN	lb.	kN	lb.	kN
1/4 - 20	A1200	600	2.7	300	1.3	6	8
5/16 - 18	B1200	800	3.6	500	2.2	11	15
3/8 - 16	C1200	1000	4.4	800	3.6	19	25
1/2 - 13	D1200	2000	8.9	1500	6.7	50	70
5/8 - 11	E1200	2500	11.1	1500	6.7	100	135
3/4 - 10	H1200	2500	11.1	1700	7.6	125	170
1/4 - 20	A1400	600	2.7	300	1.3	6	8
5/16 - 18		800	3.6	400	1.8	11	15
3/8 - 16	B1400	1000	4.4	750	3.3	19	25
1/2 - 13		1400	6.2	1000	4.4	50	70

For aluminum channel the pull out load is calculated by multiplying the appropriate data by 50%. For slip resistance multiply by 75%.

**Maximum Pullout and Slip Loads for Fiber Glass Channel and Channel Nuts**

Channel Nuts Size / Thread	Channel All Series	Pull Out Strength		Slip Resistance		Torque	
		lb.	kN	lb.	kN	lb.	kN
1/4 - 20	-	-	-	-	-	-	-
5/16 - 18	-	-	-	-	-	-	-
3/8 - 16	A1200	300	1.3	150	0.6	200	22.6
1/2 - 13	D1200	300	1.3	150	0.6	200	22.6

## Engineering Data & Specifications

### Design Data – Metal Framing Channel

**TABLE 3**  
**Design loads for channel used as beam or column**

**BEAM LOADS**

Table 3 contains simple beam, uniformly-distributed loads calculated at 25,000 psi material stress. Beam loads are based on channel being loaded across the x-x axis. Loads are also listed at reduced deflections for long spans.

**Maximum loads at 25,000 psi stress**

Maximum allowable deflections and maximum uniform loads for all spans at 25,000 psi material stress.

**Reduced load for all 1/180 Span Deflection**

For moderate deflections on the longer spans, reduced loads are listed which will produce a deflection equal to 1/180 of the span. When maximum loads do not induce deflections exceeding 1/180 x the span length reduced loads are not required.

**Reduced load for 1/360 Span Deflection**

For very slight deflections on the longer spans, reduced loads are listed which will produce a deflection equal to 1/360 of the span. When maximum loads do not induce deflections exceeding 1/360 x the span length reduced loads are not required.

**Concentrated loads**

To obtain values for concentrated loads from Table 3, multiply uniform load by 0.5 and deflection by 1.25.

**Slotted, Punched, or KO Channel**

Reduce load rating by 5%.

**Long span deep beams**

Support in a manner to prevent rotation at supports and tie between supports to prevent twist.

**COLUMN LOADS**

Allowable column loads given are for uniform axial loading with pinned ends. For eccentric loading or other end conditions reduce allowable loads according to standard engineering practice.

**DYNAMIC LOADS**

Allowable dynamic loads may be calculated by dividing the static loads shown in Table 3, by 2.08.

Maximum beam and column loading for special materials is multiplied with the following factors:

Channel Type	Beam Type	Column Load
Stainless Steel	1	1
Aluminum	0.33	0.33

**Warning**

Load tables, charts and design criteria provided in this section are intended as guides only. Selection of proper product, installation intervals, erection, and placement are the responsibility of the user.

Thomas & Betts reserves the right to change material and finish specifications without notice, to improve its products.

## Engineering Data & Specifications

### Design Data – Metal Framing Channel

**TABLE 3 (cont'd.)**

Single Channel									
Cat. No.	Depth (in.)	Ga.	Maximum Uniform		1/180 Span		1/360 Span		Col. Load
			Load	Defl.	Load	Defl.	Load	Defl.	
<b>12 in. Beam or Column</b>									
A1200	1-5/8	12	3,534	0.014	0.067			0.033	10,533
B1200	13/16		1,050	0.026					6,683
C1200	1-3/8		2,584	0.016					9,345
D1200	1		1,538	0.022					8,670
E1200	2-7/16		6,650	0.010					13,830
H1200	3-1/4		10,583	0.008					17,106
A1400	1-5/8	14	2,434	0.015	0.067			0.033	7,575
B1400	13/16		850	0.028					4,950
<b>18 in. Beam or Column</b>									
A1200	1-5/8	12	2,355	0.033	0.100			0.050	10,2100
B1200	13/16		700	0.059					6,058
C1200	1-3/8		1,723	0.038					8,970
D1200	1		1,025	0.052					7,930
E1200	2-7/16		4,434	0.023					13,482
H1200	3-1/4		7,055	0.016					16,693
A1400	1-5/8	14	1,623	0.031	0.100		453	0.050	7,334
B1400	13/16		566	0.063					4,150
<b>24 in. Beam or Column</b>									
A1200	1-5/8	12	1,766	0.058	0.133		333	0.067	9,842
B1200	13/16		525	0.105					5,315
C1200	1-3/8		1,291	0.066					8,545
D1200	1		769	0.087					7,050
E1200	2-7/16		3,325	0.039					13,082
H1200	3-1/4		5,291	0.030					16,277
A1400	1-5/8	14	1,216	0.056	0.133		258	0.067	7,058
B1400	13/16		425	0.110					4,000
<b>30 in. Beam or Column</b>									
A1200	1-5/8	12	1,414	0.089	0.167		266	0.083	9,419
B1200	13/16		420	0.164					4,465
C1200	1-3/8		1,034	0.104					8,060
D1200	1		0.615	0.129					6,650
E1200	2-7/16		2,660	0.063					12,640
H1200	3-1/4		4,234	0.046					15,698
A1400	1-5/8	14	974	0.088	0.167		165	0.083	6,753
B1400	13/16		340	0.172					3,420

Double Channel									
Cat. No.	Depth (in.)	Ga.	Maximum Uniform		1/180 Span		1/360 Span		Col. Load
			Load	Defl.	Load	Defl.	Load	Defl.	
<b>12 in. Beam or Column</b>									
A1202	3-1/4	12		0.008	0.067			0.033	21,177
B1202	1-5/8	12	3,016	0.016					14,110
C1202	2-3/4	12		0.010					18,990
D1202	2	12		0.012					18,312
E1202	4-7/8	12		0.005					27,623
H1202	6-1/2	12		0.004					34,210
A1402	3-1/4	14		0.008	0.067			0.033	15,250
B1402	1-5/8	14	2,300	0.016					10,390
<b>18 in. Beam or Column</b>									
A1202	3-1/4	12		0.018	0.100			0.050	20,609
B1202	1-5/8	12	2,011	0.036					13,440
C1202	2-3/4	12	4,811	0.021					18,470
D1202	2	12		0.028					17,942
E1202	4-7/8	12		0.013					16,926
H1202	6-1/2	12		0.009					33,390
A1402	3-1/4	14		0.018	0.100			0.050	14,867
B1402	1-5/8	14	1,534	0.036					9,910
<b>24 in. Beam or Column</b>									
A1202	3-1/4	12	4,858	0.031	0.133			0.067	19,974
B1202	1-5/8	12	1,509	0.064					12,670
C1202	2-3/4	12	3,609	0.038					17,890
D1202	2	12	2,680	0.042					17,160
E1202	4-7/8	12		0.021					26,143
H1202	6-1/2	12		0.016					32,435
A1402	3-1/4	14	3,425	0.033	0.133			0.067	14,426
B1402	1-5/8	14	1,150	0.064					9,350
<b>30 in. Beam or Column</b>									
A1202	3-1/4	12	3,886	0.049	0.167			0.083	19,261
B1202	1-5/8	12	1,206	0.100					11,803
C1202	2-3/4	12	2,886	0.059					17,230
D1202	2	12	2,128	0.084					16,480
E1202	4-7/8	12	7,806	0.034					25,259
H1202	6-1/2	12		0.025					31,395
A1402	3-1/4	14	2,740	0.050	0.167			0.083	13,937
B1402	1-5/8	14	920	0.100					8,730

When no numbers are shown, use the maximum uniform load.

Deflections are given in inches; loads in lb.

## Engineering Data & Specifications

### Design Data – Metal Framing Channel

**TABLE 3 (cont'd.)**

Single Channel									
Cat. No.	Depth (in.)	Ga.	Maximum Uniform		1/180 Span		1/360 Span		Col. Load
			Load	Defl.	Load	Defl.	Load	Defl.	
<b>36 in. Beam or Column</b>									
A1200	1-5/8	12	1,178	0.129	0.200		917	0.100	8,962
B1200	13/16		350	0.236			148		3,498
C1200	1-3/8		861	0.149			578		7,525
D1200	1		513	0.198			217		4,335
E1200	2-7/16		2,216	0.088					12,160
H1200	3-1/4		3,528	0.068					15,132
A1400	1-5/8	14	811	0.126	0.200		640	0.100	6,416
B1400	13/16		284	0.248			115		2,755
<b>42 in. Beam or Column</b>									
A1200	1-5/8	12	1,010	0.175	0.233	217	674	0.117	8,466
B1200	13/16		300	0.323			109		2,579
C1200	1-3/8		738	0.203			425		6,945
D1200	1		440	0.264			160		3,280
E1200	2-7/16		1,900	0.120					11,698
H1200	3-1/4		3,024	0.091					14,514
A1400	1-5/8	14	695	0.160	0.233	168	470	0.117	6,051
B1400	13/16		243	0.336			84		2,060
<b>48 in. Beam or Column</b>									
A1200	1-5/8	12	884	0.228	0.267	244	516	0.133	7,943
B1200	13/16		263	0.420			83		1,981
C1200	1-3/8		646	0.265			325		6,325
D1200	1		384	0.352			122		2,439
E1200	2-7/16		1,663	0.156					11,092
H1200	3-1/4		2,646	0.120					13,850
A1400	1-5/8	14	609	0.120	0.267	129	360	0.133	5,658
B1400	13/16		213	0.440			64		1,580
<b>54 in. Beam or Column</b>									
A1200	1-5/8	12	785	0.289	0.300	193	408	0.150	7,369
B1200	13/16		234	0.533			66		1,555
C1200	1-3/8		574	0.335			257		5,650
D1200	1		341	0.466			96		2,012
E1200	2-7/16		1,478	0.198			1,123		10,505
H1200	3-1/4		2,351	0.151					13,150
A1400	1-5/8	14	541	0.286	0.300	102	284	0.150	5,241
B1400	13/16		189	0.556			51		1,250

Double Channel										
Cat. No.	Depth (in.)	Ga.	Maximum Uniform		1/180 Span		1/360 Span		Col. Load	
			Load	Defl.	Load	Defl.	Load	Defl.		
<b>36 in. Beam or Column</b>										
A1202	3-1/4	12	3,239	0.071	0.200			0.100	18,470	
B1202	1-5/8		1,005	0.144					702	10,840
C1202	2-3/4		2,400	0.085						16,500
D1202	2		1,428	0.114					1248	15,057
E1202	4-7/8		6,505	0.048						24,316
H1202	6-1/2			0.036						30,265
A1402	3-1/4	14	2,284	0.071	0.200			0.100	13,416	
B1402	1-5/8		766	0.144					535	8,050
<b>42 in. Beam or Column</b>										
A1202	3-1/4	12	2,776	0.098	0.233			0.117	17,635	
B1202	1-5/8		863	0.195					516	9,790
C1202	2-3/4		2,063	0.115						15,730
D1202	2		1,224	0.166					1069	13,042
E1202	4-7/8		5,576	0.065						23,272
H1202	6-1/2			0.049						29,025
A1402	3-1/4	14	1,958	0.225	0.233			0.117	12,832	
B1402	1-5/8		658	0.195					393	7,300
<b>48 in. Beam or Column</b>										
A1202	3-1/4	12	2,429	0.128	0.267			0.133	16,730	
B1202	1-5/8		754	0.255					395	8,640
C1202	2-3/4		1,804	0.151						14,890
D1202	2		1,071	0.203					702	11,387
E1202	4-7/8		4,879	0.085						22,170
H1202	6-1/2			0.064						27,700
A1402	3-1/4	14	1,713	0.128	0.267			0.133	12,223	
B1402	1-5/8		575	0.255					301	6,480
<b>54 in. Beam or Column</b>										
A1202	3-1/4	12	2,159	0.161	0.300			0.150	15,763	
B1202	1-5/8		670	0.323					312	7,405
C1202	2-3/4		1,604	0.190					1,263	13,990
D1202	2		952	0.266					624	10,391
E1202	4-7/8		4,338	0.108						20,980
H1202	6-1/2		7,149	0.081						16,280
A1402	3-1/4	14	1,523	0.161	0.300			0.150	11,566	
B1402	1-5/8		511	0.323					238	5,580

When no numbers are shown, use the maximum uniform load.  
Deflections are given in inches; loads in lb.

## Engineering Data & Specifications

### Design Data – Metal Framing Channel

**TABLE 3 (cont'd.)**

Single Channel									
Cat. No.	Depth (in.)	Ga.	Maximum Uniform		1/180 Span		1/360 Span		Col. Load
			Load	Defl.	Load	Defl.	Load	Defl.	
<b>60 in. Beam or Column</b>									
A1200	1-5/8	12	706	0.358	0.333	157	330	0.167	6,762
B1200	13/16		210	0.658			53		-
C1200	1-3/8		516	0.414			208		4,920
D1200	1		308	0.550			78		1,561
E1200	2-7/16		1,330	0.244			909		9,874
H1200	3-1/4		2,116	0.186					12,406
A1400	1-5/8	14	486	0.353	0.333	82	231	0.167	4,792
B1400	13/16		170	0.687			41		-
<b>66 in. Beam or Column</b>									
200	1-5/8	12	643	0.432	0.367	129	273	0.183	6,127
B1200	13/16		191	0.795			44		-
C1200	1-3/8		470	0.501			172		4,145
D1200	1		280	0.675			65		1,280
E1200	2-7/16		1,210	0.295			753		9,211
H1200	3-1/4		1,924	0.226					11,616
A1400	1-5/8	14	443	0.426	0.367	68	190	0.183	4,311
B1400	13/16		155	0.831			35		-
<b>72 in. Beam or Column</b>									
A1200	1-5/8	12	589	0.514	0.400	108	299	0.200	5,436
B1200	13/16		175	0.946			37		-
C1200	1-3/8		430	0.595			144		3,485
D1200	1		256	0.792			54		1,084
E1200	2-7/16		1,108	0.351			632		8,509
H1200	3-1/4		1,839	0.269			1,313		10,782
A1400	1-5/8	14	405	0.506	0.400	57	160	0.200	3,809
B1400	13/16		141	0.989			29		-
<b>84 in. Beam or Column</b>									
A1200	1-5/8	12	505	0.700	0.467	92	168	0.233	4,061
B1200	13/16			54			27		-
C1200	1-3/8		369	0.811			106		2,565
D1200	1		220	1.079			58		796
E1200	2-7/16		950	0.479			464		6,991
H1200	3-1/4		1,513	0.366			965		8,988
A1400	1-5/8	14	348	0.691	0.467	42	118	0.233	2,827
B1400	13/16						21		-

Double Channel											
Cat. No.	Depth (in.)	Ga.	Maximum Uniform		1/180 Span		1/360 Span		Col. Load		
			Load	Defl.	Load	Defl.	Load	Defl.			
<b>60 in. Beam or Column</b>											
A1202	3-1/4	12	1,944	0.199	0.333			0.167		14,738	
B1202	1-5/8		604	0.398						253	6,100
C1202	2-3/4		1,444	0.235						1,023	13,050
D1202	2		257	0.318						449	7,531
E1202	4-7/8		3,904	0.133							19,734
H1202	6-1/2		6,434	0.100							24,810
A1402	3-1/4	14	1,370	0.199	0.333			.167		10,878	
B1402	1-5/8		460	0.399						193	4,640
<b>66 in. Beam or Column</b>											
A1202	3-1/4	12	1,766	0.240	0.367	418	593	0.183		13,646	
B1202	1-5/8		549	0.481						209	5,055
C1202	2-3/4		1,313	0.285						846	12,030
D1202	2		779	0.377						360	6,581
E1202	4-7/8		3,549	0.180							18,415
H1202	6-1/2		5,849	0.120							23,230
A1402	3-1/4	14	1,245	0.241	0.367	318		0.183		10,133	
B1402	1-5/8		419	0.483						159	3,840
<b>72 in. Beam or Column</b>											
A1202	3-1/4	12	1,620	0.286	0.400	351	468	0.200		12,500	
B1202	1-5/8		503	0.574						176	4,230
C1202	2-3/4		1,203	0.339						710	10,980
D1202	2		714	0.457						312	5,230
E1202	4-7/8		3,253	0.191							17,023
H1202	6-1/2		5,361	0.143							21,560
A1402	3-1/4	14	1,141	0.286	0.400	267		0.200		9,340	
B1402	1-5/8		384	0.574						134	3,220
<b>84 in. Beam or Column</b>											
A1202	3-1/4	12	1,388	0.390	0.467	258	344	0.233		9,992	
B1202	1-5/8		431	0.780						129	3,100
C1202	2-3/4		1,031	0.461						522	8,670
D1202	2		612	0.623						229	3,842
E1202	4-7/8		2,788	0.260							13,993
H1202	6-1/2		4,595	0.195							17,975
A1402	3-1/4	14	979	0.390	0.467	197		0.233		7,682	
B1402	1-5/8		329	0.781						98	2,370

When no numbers are shown, use the maximum uniform load.

Deflections are given in inches; loads in lb.

## Engineering Data & Specifications

### Design Data – Metal Framing Channel

**TABLE 3 (cont'd.)**

Single Channel										
Cat. No.	Depth (in.)	Ga.	Maximum Uniform		1/180 Span		1/360 Span		Col. Load	
			Load	Defl.	Load	Defl.	Load	Defl.		
<b>96 in. Beam or Column</b>										
A1200	1-5/8	12	441	0.914	258	0.533	129	0.267	3,108	
B1200	13/16				42		21		-	
C1200	1-3/8		323	1.059	163		81		1,960	
D1200	1		192	1.400	998		49		-	
E1200	2-7/16		831	0.730			355		5,423	
H1200	3-1/4		1,323	0.478			739		7,059	
A1400	1-5/8	14	304	0.903	180	0.533	90	0.267	2,615	
B1400	13/16				32		16		-	
<b>108 in. Beam or Column</b>										
A1200	1-5/8	12	393	1.156	204	0.600	102	0.300	2,456	
B1200	13/16				33		16		-	
C1200	1-3/8		288	1.350	128		64		-	
D1200	1		171	1.783	76		38		-	
E1200	2-7/16		739	0.790	561		281		4,291	
H1200	3-1/4		1,176	0.605			584		5,579	
A1400	1-5/8	14	270	1.141	142	0.600	71	0.300	1,708	
B1400	13/16				25		13		-	
<b>120 in. Beam or Column</b>										
A1200	1-5/8	12	354	1.425	165	0.667	83	0.333	-	
B1200	13/16				27		13		-	
C1200	1-3/8		259	1.663	104		52		-	
D1200	1		154	2.202	62		31		-	
E1200	2-7/16		665	0.976	455		227		3,478	
H1200	3-1/4		1,059	0.746			473		4,521	
A1400	1-5/8	14	244	1.413	114	0.667	57	0.333	-	
B1400	13/16				21		10		-	
<b>144 in. Beam or Column</b>										
A1200	1-5/8	12			115	0.800	57	0.400	-	
B1200	13/16								-	
C1200	1-3/8				72		36		-	
E1200	2-7/16		554	1.400	315		158		0.400	-
H1200	3-1/4		883	1.075	657		328		-	
A1400	1-5/8		14				80		0.800	40
B1400	13/16						-			

When no numbers are shown, use the maximum uniform load.  
Deflections are given in inches; loads in lb.

Double Channel									
Cat. No.	Depth (in.)	Ga.	Maximum Uniform		1/180 Span		1/360 Span		Col. Load
			Load	Defl.	Load	Defl.	Load	Defl.	
<b>96 in. Beam or Column</b>									
A1202	3-1/4	12	1,215	0.509		0.533	637	0.267	7,675
B1202	1-5/8		378	1.019	197		99		-
C1202	2-3/4		903	0.603			400		6,640
D1202	2		535	0.813	263		176		2,942
E1202	4-7/8		2,440	0.340			1,917		10,875
H1202	6-1/2		4,021	0.255					14,120
A1402	3-1/4	14	856	0.509		0.533	449	0.267	5,951
B1402	1-5/8		288	1.020	150		75		-
<b>108 in. Beam or Column</b>									
A1202	3-1/4	12	1,080	0.644		0.600	503	0.300	6,071
B1202	1-5/8		355	1.290	156		78		-
C1202	2-3/4		801	0.763	632		316		5,250
D1202	2		476	1.029	208		139		2,324
E1202	4-7/8		2,169	0.430			1,515		8,599
H1202	6-1/2		3,574	0.323					11,160
A1402	3-1/4	14	761	0.644		0.600	355	.300	4,702
B1402	1-5/8		255	1.290	119		59		-
<b>120 in. Beam or Column</b>									
A1202	3-1/4	12	971	0.795		0.667	408	0.333	-
B1202	1-5/8		301	1.588	126		63		-
C1202	2-3/4		721	0.941	512		256		4,250
D1202	2		428	1.271	168		112		1,883
E1202	4-7/8		1,951	0.531			1,227		6,946
H1202	6-1/2		3,216	0.398					9,040
A1402	3-1/4	14	685	0.796		0.667	287	0.333	3,805
B1402	1-5/8		230	1.600	96		48		-
<b>144 in. Beam or Column</b>									
A1202	3-1/4	12	810	1.145	566	0.800	283	0.400	-
B1202	1-5/8				88		44		-
C1202	2-3/4		601	1.350	355		178		-
E1202	4-7/8		1,626	0.764			852		-
H1202	6-1/2		2,680	0.573			1,873		-
A1402	3-1/4		14	571	1.146		399		0.800
B1402	1-5/8				67	33	-		

## Engineering Data & Specifications

### Design Data – Metal Framing Channel

**TABLE 3 (cont'd.)**

Single Channel									
Cat. No.	Depth (in.)	Ga.	Maximum Uniform		1/180 Span		1/360 Span		Col. Load
			Load	Defl.	Load	Defl.	Load	Defl.	
<b>168 in. Beam or Column</b>									
A1200	1-5/8	12			84	0.933	42	0.467	-
-	-	-							-
C1200	1-3/8				53		27		-
E1200	2-7/16	12	475	1.912	233	0.933	116	0.467	-
H1200	3-1/4		756	1.463	482		241		-
A1400	1-5/8	14			60	0.933	30	0.467	-
<b>192 in. Beam or Column</b>									
-	-	-							-
-	-	-							-
E1200	2-7/16	12			178		89		-
H1200	3-1/4		661	1.91	369	1.07	185	0.533	-
-	-	-							-
<b>216 in. Beam or Column</b>									
-	-	-							-
-	-	-							-
E1200	2-7/16	12			140		70		-
H1200	3-1/4				292	1.20	146	0.600	-
-	-	-							-
<b>240 in. Beam or Column</b>									
-	-	-							-
-	-	-							-
E1200	2-7/16	12			114	0.334	57	0.667	-
H1200	3-1/4				236		118		-
-	-	-							-

Double Channel									
Cat. No.	Depth (in.)	Ga.	Maximum Uniform		1/180 Span		1/360 Span		Col. Load
			Load	Defl.	Load	Defl.	Load	Defl.	
<b>168 in. Beam or Column</b>									
A1202	3-1/4		694	1.563	916		208		-
B1202	1-5/8				64		32		-
C1202	2-3/4	12	515	1.850	261	0.933	130	0.467	-
E1202	4-7/8		1,394	1.040	1,255		626		-
H1202	6-1/2		2,298	0.780			1,326		-
A1402	3-1/4	14	489	1.563	293	0.933	147	0.467	-
B1402	1-5/8				49		25		-
<b>192 in. Beam or Column</b>									
A1202	3-1/4	12			318	1.07	159	0.533	-
-	-	-							-
C1202	2-3/4				200		100		-
E1202	4-7/8	12	1,220	1.363	958	1.07	479	0.533	-
H1202	6-1/2		2,010	1.019			1,053		-
A1402	3-1/4	14			224	1.07	112	0.533	-
-	-	-							-
<b>216 in. Beam or Column</b>									
A1202	3-1/4	12			252	1.20	126	0.600	-
-	-	-							-
C1202	2-3/4				158		79		-
E1202	4-7/8	12	1,084	1.725	757	1.20	379	0.600	-
H1202	6-1/2		1,788	1.288			832		-
A1402	3-1/4	14			177	1.20	89	0.600	-
-	-	-							-
<b>240 in. Beam or Column</b>									
A1202	3-1/4	12			204	1.33	102	0.667	-
-	-	-							-
C1202	2-3/4				128		64		-
E1202	4-7/8	12			613	1.33	307	0.667	-
H1202	6-1/2		1,609	1.588			674		-
A1402	3-1/4	14			144	1.33	72	.667	-
-	-	-							-

When no numbers are shown, use the maximum uniform load.

Deflections are given in inches; loads in lb.

## Engineering Data & Specifications

### Design Data – Metal Framing Channel

**TABLE 4**

Safe bearing loads for 1-5/8 in. channel and combinations.

Safety factor of 2-1/2

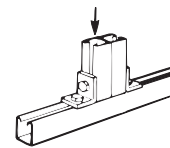
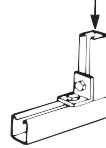
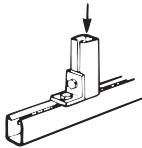

Section	Recommended Load in lb.
A1200	5000
A1400	3500
B1200	6000
B1400	3400
C1200	5000
E1200	5000
H1200	4000

Section	Recommended Load in lb.
A1200	3500
A1400	2500
B1200	4000
B1400	2600
C1200	3500
E1200	3500
H1200	2000

Section	Recommended Load in lb.
A1200	8000
A1400	5500
B1200	9000
B1400	4800
C1200	8000
E1200	8000
H1200	5500

**TABLE 5**

Design load table for typical channel connections.

Safety factor of 2-1/2 based on ultimate strength of the connection. Load diagrams indicate up to three design loads, for 12 gauge and 14 gauge channel applications.

**90° Fittings (When used in position shown)**

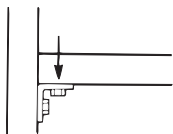

Both ends supported

AB202	A1200	1500 lb.
	A1400	1000 lb.

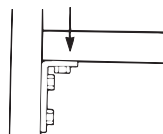

Both ends supported

AB203	A1200	2000 lb.
	A1400	1500 lb.



AB201	AB203
700 lb.	700 lb.

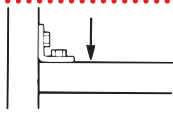

Both ends supported

AB202	A1200	1000 lb.
	A1400	650 lb.

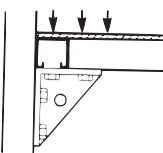

Both ends supported

AB213	A1200	3000 lb.
AB214	A1400	2000 lb.

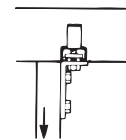

AB20	1500 lb.
------	----------

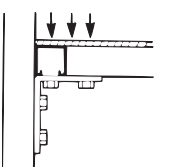

Both ends supported

AB205	A1200	2000 lb.
AB216	A1400	2000 lb.

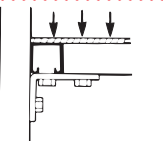

Both ends supported

AB204	A1200	1500 lb.
AB215	A1400	1000 lb.

**Flat Plate Fittings**

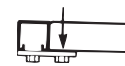

Both ends supported

AB206	A1200	1000 lb.
	A1400	800 lb.



## Engineering Data & Specifications

### Design Applications

#### CANTILEVER BEAMS

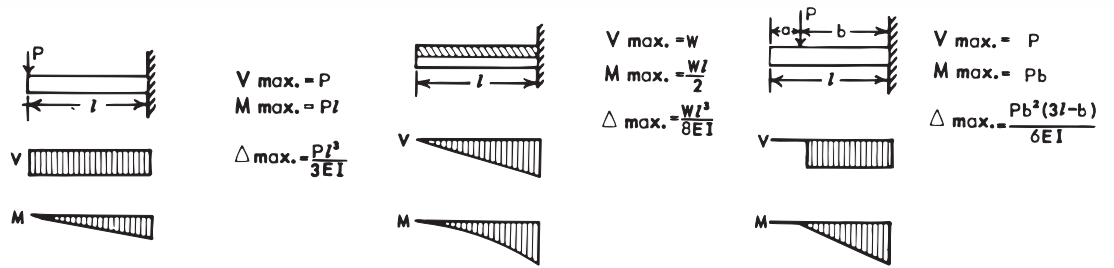

#### SIMPLE BEAMS

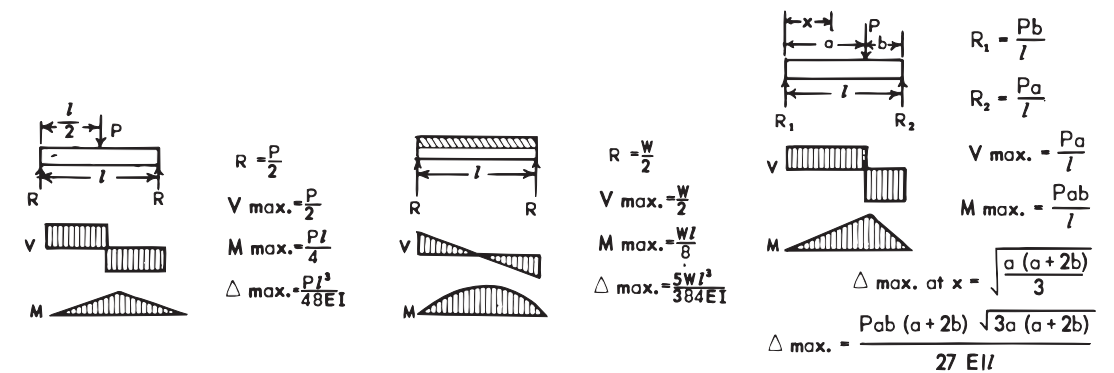

#### BEAMS FIXED ON ONE END, SUPPORTED AT THE OTHER END

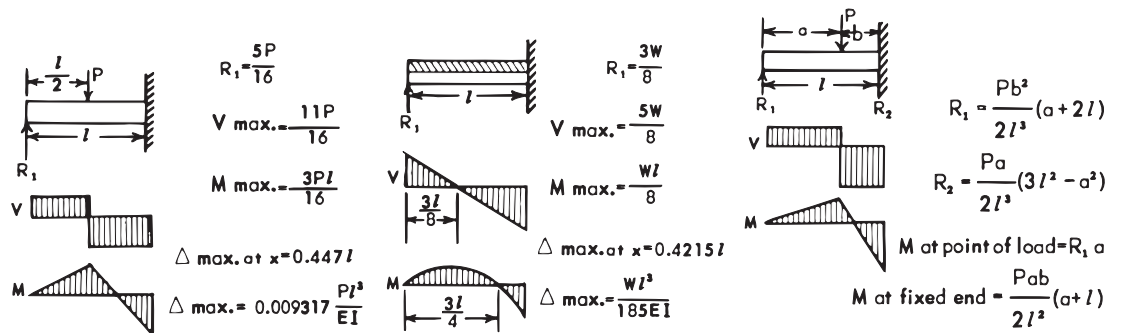

#### BEAMS FIXED AT BOTH ENDS

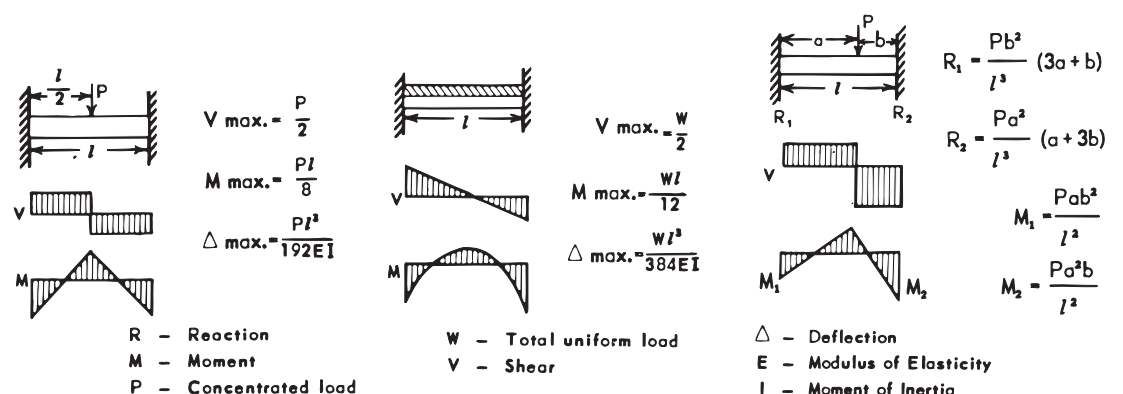







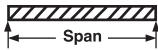

## Engineering Data & Specifications

### Design Applications

**TABLE 6**

**Conversion Factors for Beams with Various Static Loading Conditions**

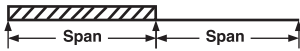
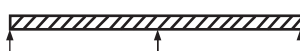
Load tables on pages A59 through A63 for A, B, C, E, and H Series channel are for single span beams supported at the ends. These can be used in the majority of cases. There are times when it is necessary to know what happens with other loading and support conditions. Some common arrangements are shown in Table 6. Simply multiply the loads from the Design Load Tables times the factors given in Table 6.

LOAD AND SUPPORT CONDITION		LOAD FACTOR	DEFLECTION FACTOR
1.	Simple Beam - Uniform Load 	1.00	1.00
2.	Simple Beam - Concentrated Load at Center 	0.50	1.25
3.	Simple Beam - Two Equal Concentrated Loads at 1/4 Points 	1.00	1.10
4.	Beam Fixed at Both Ends - Uniform Load 	1.50	0.30
5.	Beam Fixed at Both Ends - Concentrated Load at Center 	1.00	0.40
6.	Cantilever Beam - Uniform Load 	0.25	2.40
7.	Cantilever Beam - Concentrated Load at End 	0.12	3.20
8.	Continuous Beam - Two Equal Spans - Uniform Load on One Span 	1.30	0.92
9.	Continuous Beam - Two Equal Spans - Uniform Load on Both Ends 	1.00	0.42
10.	Continuous Beam - Two Equal Spans - Concentrated Load at Center of One Span 	0.62	0.71
11.	Continuous Beam - Two Equal Spans - Concentrated Load at Center of Both Spans 	0.67	0.48

## Engineering Data & Specifications

### Design Applications

#### EXAMPLE I

**PROBLEM:**

Determine the load and deflection of an A1200 beam continuous over one support and loaded uniformly on one span.



**SOLUTION:**

- A. From load table 3 for A1200 the load for a 5 ft. 0 in. span is 706 lb. and deflection is 0.358 in.
- B. Multiply by factors from Table 6.  
Load = 706 lb. x 1.30 = 917.8 lb.  
Deflection = 0.358 x 0.92 = 0.329 in.

#### EXAMPLE II

**PROBLEM:**

Determine load and deflection of an E1200 cantilever beam with a concentrated load on the end.



**SOLUTION:**

- A. From load table 3 for E1200 the load for a 3 ft. 0 in. span is 2216 lb. and deflection is 0.088 in.
- B. Multiply by factors from Table 6.  
Load = 2216 lb. x .12 = 265.9 lb.  
Deflection = 0.088 x 3.20 = 0.282 in.

### COLUMN LOADING

The load bearing capacity of column or compression members is a function of the inherent configurational strength, the unbraced length and design of the end connections.

Values of axial column loading given in Table 3 were calculated using a rotationally free and translation fixed correction at each end (see illustration I). This gives an end condition constant (K) of 1.

If other end conditions are used, axial loading should be calculated using procedures in the AISI specification for the design of cold formed steel structural members (SG671) and the engineering values for Superstrut® channel given in Table 1.

ILLUSTRATION I

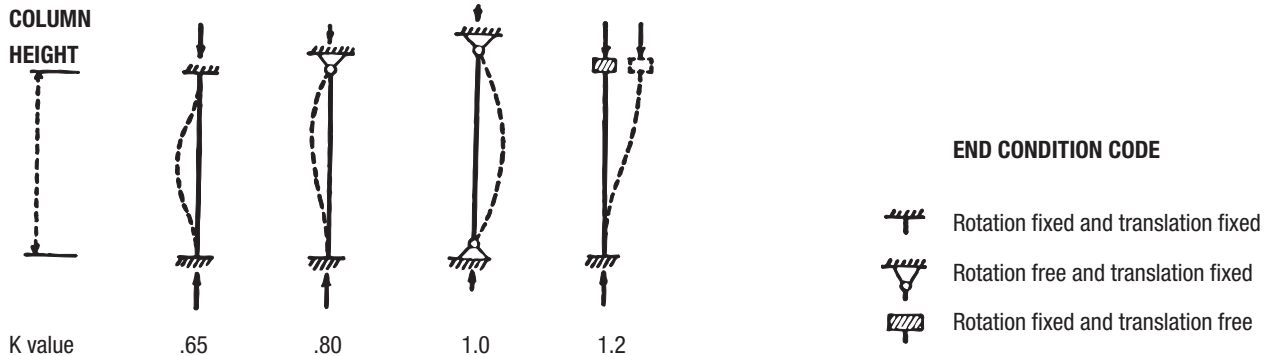

**TABLE 7**

Load Carrying Capacities of Hot Rolled Steel Rod

Nominal Rod Dia. (in.)	Root Area Thread (in.)	Design Load lb. for Serv. Temperature	
		343°C (650°F)	399°C (750°F)
3/8	0.068	610	540
1/2	0.126	1130	1010
5/8	0.202	1810	1610
3/4	0.302	2710	2420
7/8	0.419	3770	3360

Safety factor of 5.

**TABLE 8**

Rod Size Determined by Pipe Size for Fire Protection

Pipe Size (in.)	Rod Size (in.)
3/4 to 2	3/8
2-1/2 to 3-1/2	1/2
4 to 5	5/8
6	3/4
8 to 12	7/8

## Engineering Data & Specifications

### Design Applications

### TABLE 9

Maximum Spacing between Pipe Supports

Steel Pipe																			
Nom. Pipe Size (in.)	1/2	3/4	1		1-1/2	2	2-1/2	3	3-1/2	4	5	6	8	10	12	14	16	18	20
Max. Spacing (ft.)	5	6	7		9	10	11	12	13	14	16	17	19	22	23	25	27	28	30
Copper Pipe																			
Nom. Pipe Size (in.)	1/2	3/4	1	1-1/4	1-1/2	2	2-1/2	3	3-1/2	4									
Max. Spacing (ft.)	5	6	6	7	8	9	10	10	11	12									

### TABLE 10

Minimum Spacing (inches) between Centers of Standard Pipe When Using Superstrut #702 Pipe Straps

Nom. Pipe Size (in.)	1/2	3/4	1	1-1/4	1-1/2	2	2-1/2	3	3-1/2	4	5	6	8
1/2	1-3/16												
3/4	1-5/16	1-7/16											
1	1-1/2	1-5/8	1-3/4										
1-1/4	1-3/4	1-7/8	2	2-1/4									
1-1/2	1-15/16	2-1/16	2-3/16	2-7/16	2-9/16								
2	2-3/16	2-5/16	2-1/2	2-3/4	2-7/8	3-1/8							
2-1/2	2-7/16	2-9/16	2-3/4	3	3-1/8	3-3/8	3-5/8						
3	2-13/16	2-15/16	3-1/16	3-5/16	3-7/16	3-3/4	4	4-5/16					
3-1/2	3-1/8	3-1/4	3-3/8	3-5/8	3-3/4	4-1/16	4-5/16	4-5/8	4-15/16				
4	3-7/16	3-9/16	3-15/16	4-1/16	4-3/8	4-5/8	4-15/16	5-1/4	5-9/16				
6	4-3/4	4-7/8	5	5-1/4	5-3/8	5-5/8	5-7/8	6-3/16	6-1/2	6-13/16	7-7/16	8-1/8	
8	5-7/16	6	6-1/8	6-3/8	6-1/2	6-3/4	7	7-5/16	7-5/8	8	8-9/16	9-1/4	10-3/8

## Engineering Data & Specifications

### Design Applications

**TABLE 11**

Standard Dimensions and Weights of Piping Materials and Conduit

Mechanical (ANSI & API Standard, Schedule 40)					
Nominal Std. Pipe Size (in.)	Pipe O.D. (in.)	Coupling O.D. (in.)	Weight of Pipe lb./ft.	Weight of Pipe Filled w/Water lb./ft.	
1/2	.84	1.06	0.85	0.98	
3/4	1.05	1.31	1.13	1.36	
1	1.32	1.58	1.68	2.05	
1- 1/4	1.66	1.90	2.27	2.92	
1- 1/2	1.90	2.20	2.72	3.60	
2	2.38	2.75	3.65	5.11	
2- 1/2	2.88	3.25	5.79	7.87	
3	3.50	4.00	7.58	10.78	
3- 1/2	4.00	4.63	9.11	13.39	
4	4.50	5.00	10.79	16.30	
5	5.56	6.30	14.62	23.28	
6	6.63	7.39	18.97	31.48	
8	8.63	9.23	28.56	50.24	
10	10.75		41.00	74.00	
12	12.75		50.00	99.00	
14	14.00		64.00	122.00	
16	16.00		63.00	142.00	
18	18.00		71.00	172.00	
20	20.00		79.00	205.00	
22	22.00		87.00	240.00	
24	24.00		95.00	277.00	
26	26.00		103.00	322.00	
28	28.00		111.00	364.00	
30	30.00		119.00	410.00	

Electrical Conduit					
Nominal Conduit Size (in.)	Rigid Steel			Thin Wall (EMT)	
	Conduit O.D. (in.)	Weight of Conduit lb./ft.	Weight of Conduit w/Non-lead Covered Conductor lb./ft.	Conduit O.D. (in.)	Weight of Conduit lb./ft.
1/2	0.84	0.85	1.04	0.71	0.29
3/4	1.05	1.13	1.40	0.92	0.44
1	1.32	1.68	2.35	1.16	0.64
1- 1/4	1.66	2.28	3.58	1.51	0.95
2	2.38	3.68	7.21	2.20	1.40
2- 1/2	2.88	5.82	10.22	2.88	2.30
3	3.50	7.62	14.51	3.50	2.70
4	4.50	10.89	21.48	4.50	4.00

Includes weight of heaviest conductor combination.

## Engineering Data & Specifications

### Design Applications

**TABLE 12**

Extra Strong Pipe (ANSI & API Standard, Schedule 80)

A.S.A. B36.10 SCHEDULE NOS. AND NOMINAL WALL THICKNESS DESIGNATIONS	Nominal Pipe Size (in.)	O.D. (in.)	Wall Thickness (in.)	I.D. (in.)	Weight of Pipe lb./ft.	Water Weight per ft. of Pipe lb.	Weight of Pipe Filled w/Water lb./ft.	
EXTRA STRONG PIPE and SCHEDULE 80 PIPE (through 8 in.)	3/8	0.675	0.126	0.423	0.74	0.061	0.801	
	1/2	0.840	0.147	0.546	1.09	0.101	1.191	
	3/4	1.050	0.154	0.742	1.47	0.188	1.668	
	1	1.315	0.179	0.957	2.17	0.311	2.481	
	1-1/4	1.660	0.191	1.278	3.00	0.555	3.555	
	1-1/2	1.900	0.200	1.500	3.63	0.765	4.395	
	2	2.375	0.218	1.939	5.03	1.279	6.309	
	2-1/2	2.875	0.276	2.323	7.66	1.834	9.497	
	3	3.500	0.300	2.900	10.30	2.860	13.16	
	3-1/2	4.000	0.318	3.364	12.55	3.850	16.35	
	4	4.500	0.337	3.826	15.00	4.98	19.98	
	5	5.563	0.375	4.813	20.80	7.89	28.69	
	6	6.625	0.432	5.761	28.60	11.29	39.89	
	8	8.625	0.500	7.625	43.40	19.79	63.20	
	EXTRA STRONG PIPE (10 in. through 24 in. OD)	10	10.750	0.500	9.750	54.70	32.30	87.00
		12	12.750	0.500	11.750	65.40	47.00	112.40
14 OD		14.000	0.500	13.000	72.10	57.50	129.60	
16 OD		16.000	0.500	15.000	82.80	76.50	159.30	
18 OD		18.000	0.500	17.000	93.50	98.40	191.90	
20 OD		20.000	0.500	19.000	104.10	122.80	226.90	
24 OD		24.000	0.500	23.000	125.50	180.10	305.60	
SCHEDULE 80 PIPE (10 in. through 24 in. OD)	10	10.750	0.593	9.564	64.300	31.10	95.40	
	12	12.750	0.687	11.376	88.50	44.00	132.50	
	14 OD	14.000	0.750	12.500	106.10	53.20	159.30	
	16 OD	16.000	0.842	14.314	136.50	69.70	206.20	
	18 OD	18.000	0.937	16.126	170.80	88.50	259.30	
	20 OD	20.000	1.031	17.938	208.90	109.40	318.30	
	24 OD	24.000	1.218	21.564	296.40	158.30	454.70	

**TABLE 13**

Pipe Covering Weights (Thickness intended as guide, only)

Nominal Pipe Size (in.)	260°		360°		440°		525°		600°		700°		800°	
	Thick. (in.)	lb./ft.	Thick. (in.)	lb./ft.	Thick. (in.)	lb./ft.	Thick. (in.)	lb./ft.	Thick. (in.)	lb./ft.	Thick. (in.)	lb./ft.	Thick. (in.)	lb./ft.
1	1	0.68	1	0.68	1	0.68	1	0.68	1-1/2	1.19	1-1/2	1.19	1-1/2	1.19
1-1/4	1	0.75	1	0.75	1	0.75	1	0.75	1-1/2	1.27	1-1/2	1.27	2	1.82
1-1/2	1	0.88	1	0.88	1	0.88	1	0.88	1-1/2	1.45	1-1/2	1.45	2	1.87
2	1	1.01	1	1.01	1	1.01	1-1/2	1.53	1-1/2	1.53	2	2.50	2	2.50
2-1/2	1	1.15	1	1.15	1	1.15	1-1/2	1.69	1-1/2	1.69	2	2.50	2-1/2	3.22
3	1	1.28	1	1.28	1	1.28	1-1/2	2.09	1-1/2	2.09	2	2.98	2-1/2	3.98
3-1/2	1	1.44	1	1.44	1-1/2	2.29	1-1/2	2.29	2	3.00	2	3.12	2-1/2	4.30
4	1	1.60	1	1.60	1-1/2	2.49	1-1/2	2.49	2	3.49	2	3.49	2-1/2	4.62
5	1	1.84	1	1.84	1-1/2	2.84	1-1/2	2.84	2	3.97	2	3.97	2-1/2	5.92
6	1-1/2	3.13	1-1/2	3.13	1-1/2	3.13	1-1/2	3.13	2	4.54	2	4.54	2-1/2	6.75
8	1-1/2	4.06	1-1/2	4.06	1-1/2	4.06	1-1/2	4.06	2	5.56	2	5.56	2-1/2	7.61

Thickness and weight of calcium silicate covering.

## Engineering Data & Specifications

### Design Applications

**TABLE 14**

**Column Loading For Rack Construction**

Typical general storage rack for use with plywood or other decking.

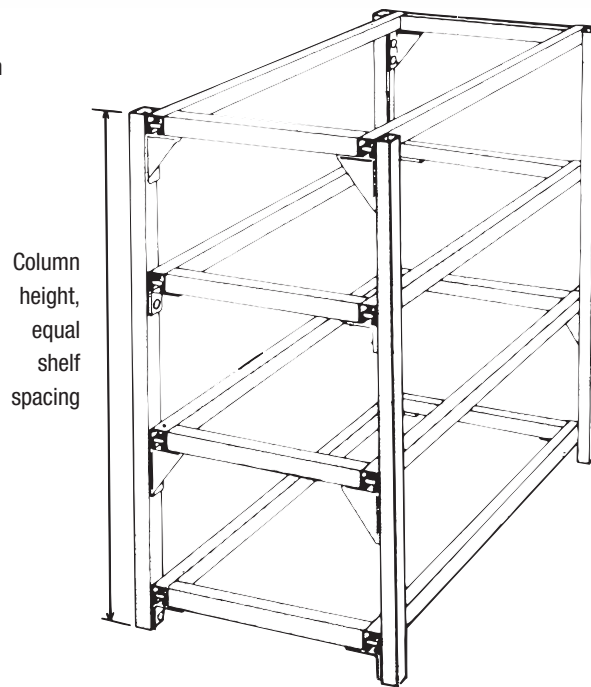

- GENERAL STORAGE RACKS
- PALLET RACKS
- BARREL RACKS
- BULK FURNITURE RACKS
- CABLE RACKS
- BAR STOCK RACKS
- DISPLAY RACKS
- SPECIAL PURPOSE RACKS

For Uniform Loads on Horizontal Members

See Table 3

Allowable load in lb. per upright										
Column Height	Cat. No.	Number of Shelves per upright								
		2	3	4	5	6	7	8	9	10
6'	A1200	2237	1925	1650	1437	1290				
	A1202	4170	3580	3100	2730	2450				
	B1400	800	820	790	700	630				
	B1402	1930	1700	1500	1300	1190				
7'	A1200	2150	1850	1630	1425	1280	1150			
	A1202	4000	3525	3000	2700	2430	2200			
	B1400	650	790	760	685	615	550			
	B1402	1800	1650	1450	1300	1180	750			
8'	A1200	2000	1820	1600	1400	1250	1150	1050		
	A1202	3900	3475	3000	2700	2400	2185	2000		
	B1400	580	750	730	660	610	540	510		
	B1402	1650	1610	1450	1300	1160	940	970		
9'	A1200	1950	1780	1575	1400	1250	1130	1030	950	
	A1202	3800	3400	3020	2675	2400	2180	1975	1800	
	B1400		600	665	600	580	540	500	475	
	B1402	1500	1500	1430	1275	1160	1000	900	800	
10'	A1200	1870	1700	1500	1300	1200	1100	1000	900	800
	A1202	3600	3300	3000	2650	2350	2000	1975	1800	1650
	B1400		550	650	625	580	535	490	450	425
	B1402	1450	1480	1400	1250	1140	1040	960	885	825

## Engineering Data & Specifications

### Design Applications – Mechanical Support

#### Example 1

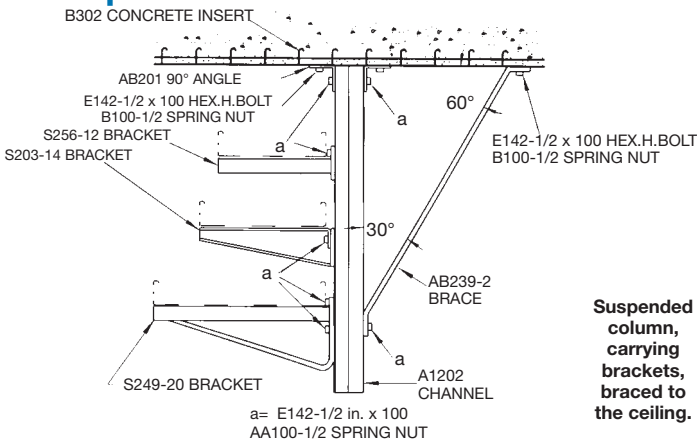

#### Example 2

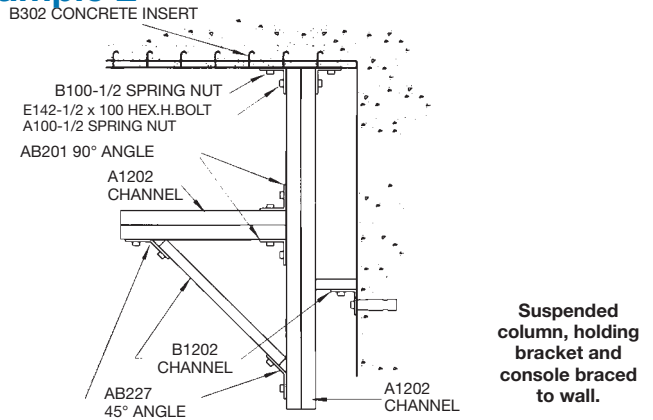

#### Example 3

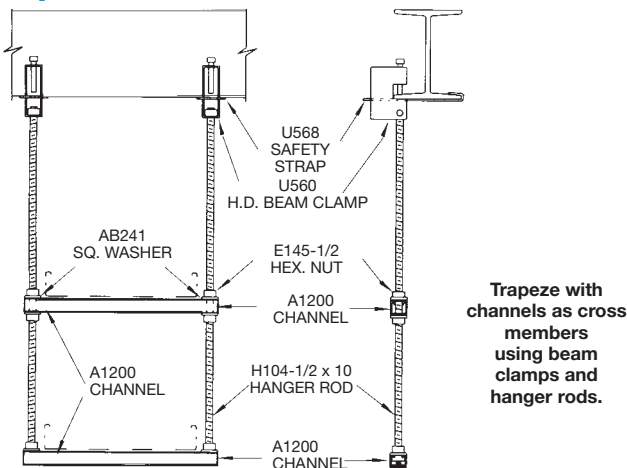

#### Example 4

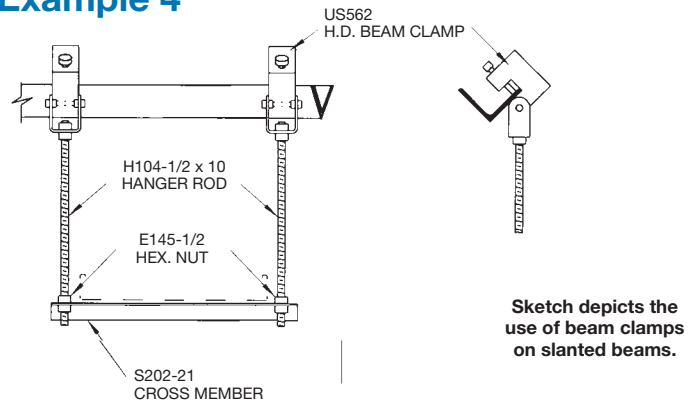

#### Example 5

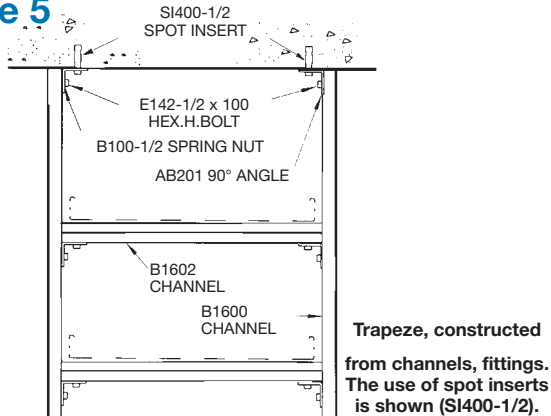

#### Example 6

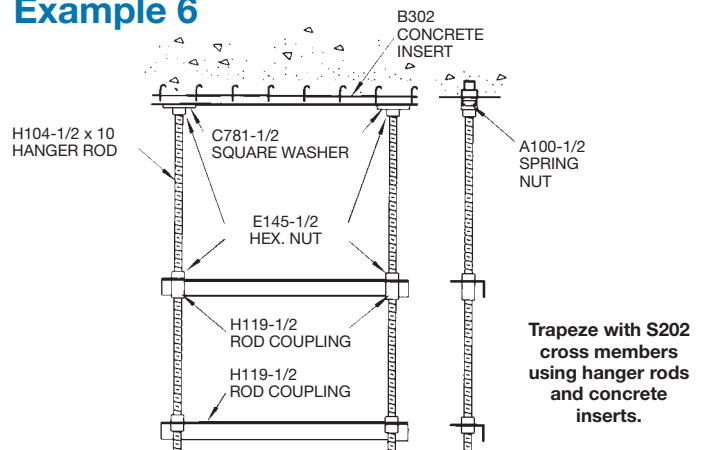



## Engineering Data & Specifications

### Design Applications – Mechanical Support

#### Example 7

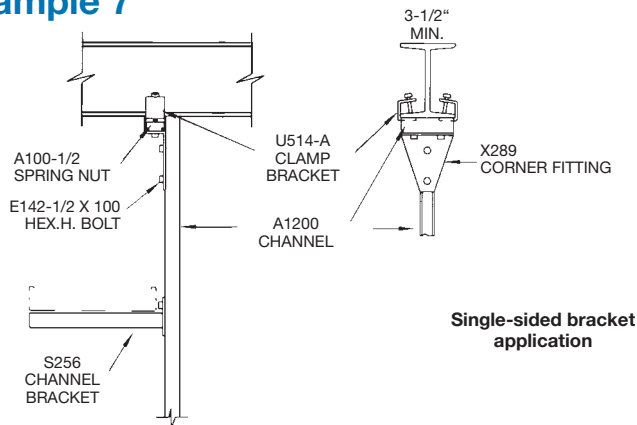

\* NOTE: BRACE SHOULD BE USED FOR LENGTHS GREATER THEN 30 IN.

#### Example 8

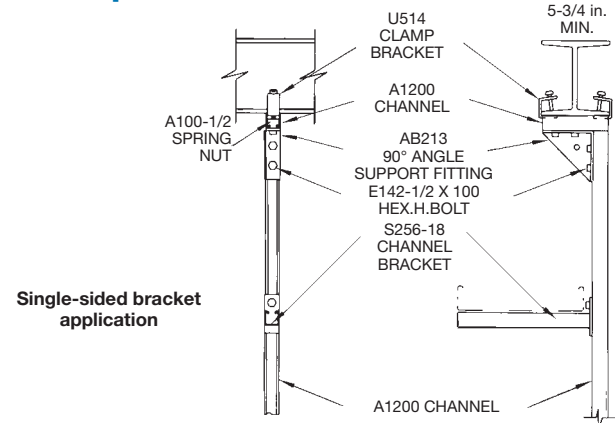

#### Example 9

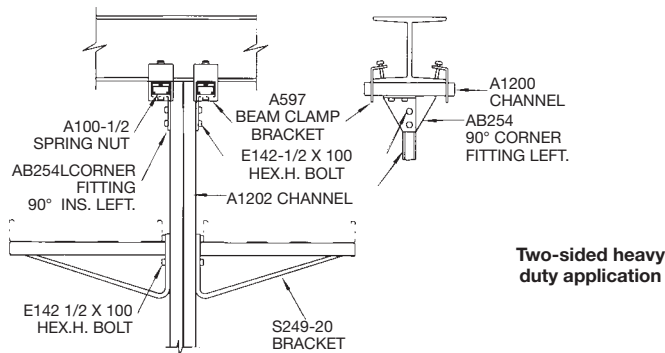

#### Example 10

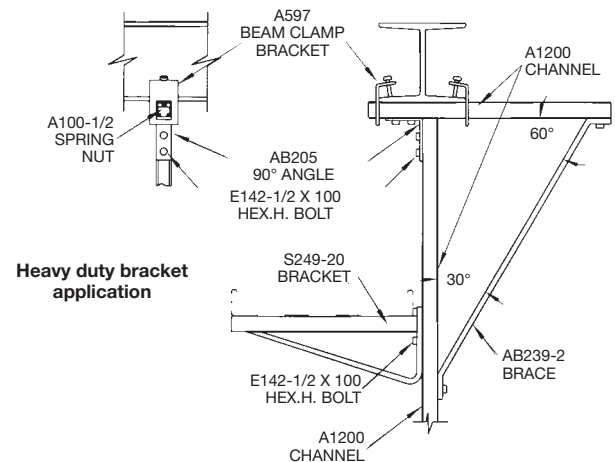

#### Example 11

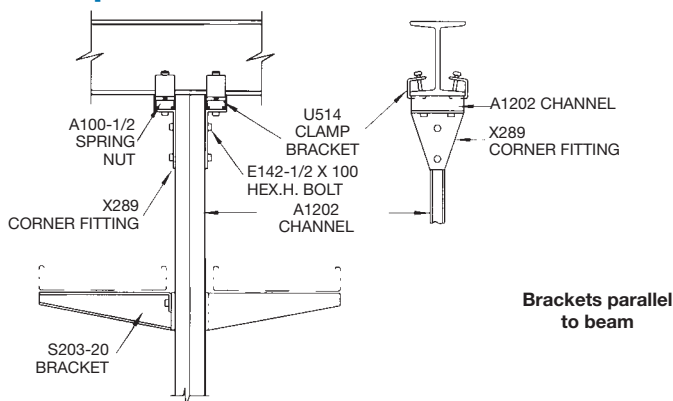

#### Example 12

